

YATO

2014



www.yato.com

PREMIUM
QUALITY

YATO 

LIGHT

ŻARÓWKI LED



720lm
3000K
CRI>80



LED



poliwęglanowy klosz odporny
na uszkodzenia mechaniczne

aluminowy korpus
malowany proszkowo



YT-81852

Żarówka LED 10 W, 720 lm



LED

YT-81851

Żarówka LED 7 W,
590 lm, 3000 K

YT-81853

Żarówka LED 12 W, 950 lm, 3000 K



160lm
3000K
CRI>80



LED

YT-81871

Żarówka LED 3 W, 160 lm, 3000 K



250lm
3000K
CRI>80



LED

YT-81861

Żarówka LED 5 W, 250 lm, 3000 K

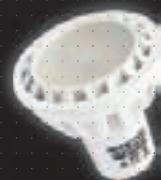

265lm
3000K
CRI>80



LED

YT-81862

Żarówka LED 5 W, 265 lm, 3000 K



www.yato.com

NOWOŚĆ

1 SPANNERS / KLUCZE 4-23



2 SOCKETS, ACCESSORIES & SETS / KLUCZE NASADOWE, AKCESORIA I ZESTAWY 24-67



3 IMPACT SOCKETS, ACCESSORIES & SETS / UDAROWE KLUCZE NASADOWE, AKCESORIA I ZESTAWY 68-77



4 TORQUE WRENCHES & TORQUE MULTIPLIERS / KLUCZE DYNAMOMETRYCZNE I WZMACNIACZE MOMENTU 78-81



5 SCREWDRIVERS & SCREWDRIVER BITS / WKREŃTAKI I KOŃCÓWKI WKREŃTAKOWE 82-111



6 PLIERS & PIPE WRENCHES / SZCZYPCE I KLUCZE DO RUR 112-129



7 ELECTRICIAN TOOLS / NARZĘDZIA DLA ELEKTRYKÓW 130-141



8 HAMMERS, CHISELS, PUNCHES & AXES / MŁOTKI, DŁUTA, PRZECINAKI I SIEKIERY 142-151



9 CLAMPS, VICES & HOLDERS / ŚCISKI, IMADŁA I WSPORNIKI 152-157



10 CUTTING TOOLS / NARZĘDZIA TNĄCE 158-205



11 HYDRAULIC TOOLS / NARZĘDZIA HYDRAULICZNE 206-211



1

Spanners Klucze



Combination spanners
Klucze płasko-oczkowe

6-9



Reversible ratchet half-moon spanners
Klucze oczkowe typu „C” z grzechotką

18



Combination spanners & sets, polished head
Klucze płasko-oczkowe i zestawy, polerowana główka

6

Flare nut wrenches & sets
Klucze oczkowe półotwarte i zestawy

18



Combination spanners & sets, satin finish
Klucze płasko-oczkowe i zestawy, wykończenie satynowe

7

Combination spanners S.A.E., polished head

8

Klucze płasko-oczkowe S.A.E., polerowana główka

Stubby combination spanners, polished head

9

Klucze płasko-oczkowe krótkie, polerowana główka

Flexible flare nut wrenches & sets

Klucze oczkowe półotwarte z przegubem i zestawy

19



Combination ratchet wrenches

Klucze płasko-oczkowe z grzechotką

9-11



Torx ring spanner sets

Zestawy kluczy oczkowych „Torx”

19



Combination ratchet wrenches & sets

Klucze płasko-oczkowe z grzechotką i zestawy

9

Non-slip combination ratchet wrenches

Klucze płasko-oczkowe z grzechotką „Non-slip”

10

Rapid spline ratchet wrenches

Klucze „szybkie” z grzechotką „Spline”

11

Flexible ratchet combination wrenches

Klucze płasko-oczkowe z grzechotką i przegubem

11

L-type socket wrenches

Klucze nasadowe typu „L”

19



Double open end spanners

Klucze płaskie

12-13



Open end swivel head socket wrenches & sets

Klucze płasko-nasadowe, przegubowe i zestawy

20



Double open end spanners & sets, polished head

Klucze płaskie i zestawy, polerowana główka

12

Double open end spanners & sets, satin finish

Klucze płaskie i zestawy, wykończenie satynowe

13

Double open end spanners S.A.E., polished head

Klucze płaskie S.A.E., polerowana główka

13

Double flexible socket wrenches & sets

Klucze nasadowe, przegubowe i zestawy

20



Tubular socket wrenches & accessories

Klucze rurowe kute i akcesoria

21



Double ratchet spanners & sets

Klucze oczkowe z grzechotką i zestawy

14



Double ratchet wrenches

Dwustronne klucze nasadowe z grzechotką

21



Bi-hexagonal ring spanners

Klucze oczkowe odgięte

14-16



T-type & Y-type socket wrenches

Klucze nasadowe typu „T” i typu „Y”

21-22



Bi-hexagonal ring spanners & sets, polished head

Klucze oczkowe odgięte i zestawy, polerowana główka

14

Bi-hexagonal ring spanners & sets, satin finish

Klucze oczkowe odgięte i zestawy, wykończenie satynowe

15

Bi-hexagonal ring spanners S.A.E., polished head

Klucze oczkowe odgięte S.A.E., polerowana główka

16

Socket wrenches with handle

Klucze nasadowe z rękojeścią

21

T-type deep socket wrenches with rotary handle

Klucze nasadowe typu „T” z obrotową rączką

22

T-type adapters with rotary handle

Adaptory typu „T” z obrotową rączką

22

T-type deep socket wrenches

Klucze nasadowe typu „T”

22

Y-type socket wrenches

Klucze nasadowe typu „Y”

22

Impact wrenches

Klucze do pobijania

17



Adjustable wrenches

Klucze nastawne

23



Ring impact wrenches

Klucze oczkowe do pobijania

17

Open end impact wrenches

Klucze płaskie do pobijania

17

Half-moon spanners

Klucze oczkowe typu „C”

18



1

GB Combination spanner
D Maulringschlüssel
PL Klucz płasko-oczkowy
RUS Ключ комбинированный
CZ Plochý a očkový klíč

H Kulcs villás-csillag
RO Cheie combinată
E Combinada con llave de estrella
CN 两用扳手

DIN 3113 CrV AS-DRIVE

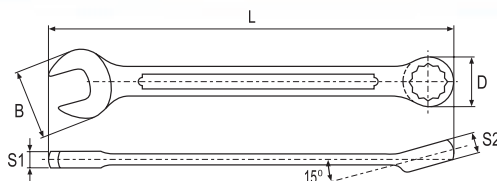

- application: workshop
- head offset: 15°
- surface finish: chromed, satin
- przeznaczenie: warsztat
- kąt odchylenia główki: 15°
- wykończenie powierzchni: chromowana, satynowa

COLOR BOX



| YATO | Ø (mm) | L (mm) | B (mm) | D (mm) | S1 (mm) | S2 (mm) | PCS packing | Image |
|---------|--------|--------|--------|--------|---------|---------|-------------|---------|
| YT-0335 | 6 | 110 | 14.8 | 10.5 | 3.7 | 4.9 | 10 | 300/600 |
| YT-0336 | 7 | 120 | 16.1 | 11.3 | 4.0 | 5.3 | 10 | 300/600 |
| YT-0337 | 8 | 130 | 18.5 | 12.9 | 4.2 | 5.0 | 10 | 180/360 |
| YT-0338 | 9 | 140 | 20.5 | 14.6 | 4.2 | 5.0 | 10 | 180/360 |
| YT-0339 | 10 | 150 | 22.2 | 16.2 | 4.9 | 6.4 | 10 | 180/360 |
| YT-0340 | 11 | 160 | 25.5 | 17.3 | 4.9 | 7.0 | 10 | 180/360 |
| YT-0341 | 12 | 170 | 26.7 | 18.7 | 5.3 | 7.6 | 10 | 120/240 |
| YT-0342 | 13 | 180 | 28.0 | 19.6 | 5.5 | 8.2 | 10 | 120/240 |
| YT-0343 | 14 | 190 | 30.3 | 21.4 | 5.9 | 7.7 | 10 | 50/100 |
| YT-0344 | 15 | 200 | 32.8 | 22.8 | 6.2 | 8.5 | 10 | 50/100 |
| YT-0345 | 16 | 210 | 33.9 | 23.7 | 6.1 | 9.1 | 10 | 50/100 |
| YT-0346 | 17 | 220 | 35.9 | 24.7 | 6.5 | 9.1 | 10 | 50/100 |
| YT-0347 | 18 | 230 | 37.8 | 26.9 | 6.9 | 10.0 | 10 | 50/100 |

| YATO | Ø (mm) | L (mm) | B (mm) | D (mm) | S1 (mm) | S2 (mm) | PCS packing | Image |
|---------|--------|--------|--------|--------|---------|---------|-------------|--------|
| YT-0348 | 19 | 235 | 38.9 | 27.7 | 7.0 | 10.1 | 10 | 50/100 |
| YT-0349 | 20 | 250 | 41.4 | 29.2 | 7.3 | 11.0 | 10 | 40/80 |
| YT-0350 | 21 | 260 | 43.4 | 31.0 | 7.1 | 10.9 | 10 | 40/80 |
| YT-0351 | 22 | 270 | 45.9 | 32.2 | 8.1 | 11.2 | 5 | 20/40 |
| YT-0352 | 23 | 280 | 47.8 | 34.3 | 7.8 | 11.1 | 5 | 20/40 |
| YT-0353 | 24 | 290 | 49.9 | 34.8 | 9.2 | 11.2 | 5 | 20/40 |
| YT-0354 | 25 | 300 | 51.2 | 36.6 | 9.2 | 12.4 | 5 | 20/40 |
| YT-0355 | 26 | 310 | 53.2 | 37.4 | 9.2 | 12.9 | 5 | 20/40 |
| YT-0356 | 27 | 320 | 55.9 | 39.3 | 9.3 | 12.7 | 5 | 15/30 |
| YT-0357 | 28 | 330 | 56.5 | 40.9 | 9.9 | 13.5 | 5 | 15/30 |
| YT-0358 | 29 | 340 | 60.0 | 42.4 | 10.0 | 13.6 | 5 | 15/30 |
| YT-0359 | 30 | 350 | 60.9 | 43.8 | 10.0 | 14.7 | 5 | 10/20 |
| YT-0360 | 32 | 370 | 64.5 | 46.6 | 11.3 | 14.9 | 5 | 10/20 |

GB Combination spanner
D Maulringschlüssel
PL Klucz płasko-oczkowy
RUS Ключ комбинированный
CZ Plochý a očkový klíč
H Kulcs villás-csillag

RO Cheie combinată
E Combinada con llave de estrella
CN 两用扳手

AS-DRIVE

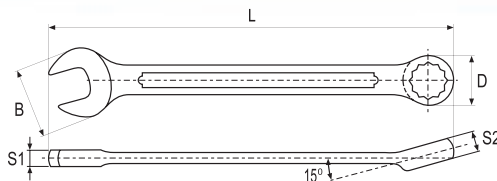

- application: workshop
- head offset: 15°
- surface finish: chromed, satin
- przeznaczenie: warsztat
- kąt odchylenia główki: 15°
- wykończenie powierzchni: chromowana, satynowa

COLOR BOX



| YATO | Ø (mm) | L (mm) | B (mm) | D (mm) | S1 (mm) | S2 (mm) | PCS packing | Image |
|----------|--------|--------|--------|--------|---------|---------|-------------|-------|
| YT-00760 | 34 | 425 | 65.2 | 51.0 | 13.0 | 16.0 | 5 | 20 |
| YT-00761 | 36 | 460 | 73.0 | 57.0 | 14.0 | 17.5 | 5 | 15 |
| YT-00762 | 38 | 460 | 73.0 | 57.0 | 14.0 | 17.5 | 5 | 15 |
| YT-00763 | 41 | 500 | 83.0 | 61.5 | 15.0 | 19.0 | 5 | 10 |
| YT-00764 | 46 | 540 | 88.3 | 69.0 | 16.5 | 21.0 | 5 | 10 |

| YATO | Ø (mm) | L (mm) | B (mm) | D (mm) | S1 (mm) | S2 (mm) | PCS packing | Image |
|----------|--------|--------|--------|--------|---------|---------|-------------|-------|
| YT-00765 | 48 | 570 | 92.0 | 72.0 | 16.5 | 22.0 | 5 | 10 |
| YT-00766 | 50 | 598 | 96.0 | 74.0 | 18.0 | 23.5 | 2 | 8 |
| YT-00767 | 55 | 620 | 105.6 | 82.4 | 19.0 | 25.0 | 2 | 6 |
| YT-00768 | 60 | 660 | 115.2 | 89.8 | 21.0 | 27.0 | 2 | 6 |
| YT-00769 | 65 | 680 | 124.8 | 97.3 | 23.0 | 29.0 | 2 | 4 |

GB Combination spanner set
D Maulringschlüsselsatz
PL Komplet kluczy płasko-oczkowych
RUS Набор ключей комбинированных
CZ Souprava plochých a očkových klíčů

H Kulcskészlet, villás-csillag
RO Set chei combinată
E Juego de combinadas con llave de estrella
CN 两用扳手组套

POUCH & COLOR BOX



DIN 3113 CrV AS-DRIVE



12 PCS 8, 9, 10, 11, 12, 13, 14, 15, 17, 19, 22, 24 mm

17 PCS 8, 9, 10, 11, 12, 13, 14, 15, 16, 17, 18, 19, 22, 24, 27, 30, 32 mm

25 PCS 6, 7, 8, 9, 10, 11, 12, 13, 14, 15, 16, 17, 18, 19, 20, 21, 22, 23, 24, 25, 26, 27, 28, 30, 32 mm

| | | |
|---------|-------|---|
| YATO | Image | 6 |
| YT-0362 | | |

| | | |
|---------|-------|---|
| YATO | Image | 3 |
| YT-0363 | | |

| | | |
|---------|-------|---|
| YATO | Image | 3 |
| YT-0365 | | |

GB Combination spanner
D Maulringschlüssel
PL Klucz płasko-oczkowy
RUS Ключ комбинированный
CZ Plochý a očkový klíč

H Kulcs villás-csillag
RO Cheie combinată
E Combinada con llave de estrella
CN 两用扳手

DIN 3113
CrV 6140
AS-DRIVE

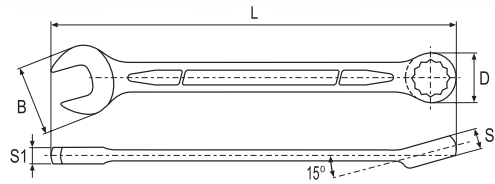

1





- application: industry
- head offset: 15°
- maximum torque exceeding DIN and ANSI standards by 60%
- surface finish: chromed, satin
- przeznaczenie: przemysł
- kąt odchylenia główki: 15°
- maksymalny moment obrotowy większy o 60% niż w standardach DIN i ANSI
- wykończenie powierzchni: chromowana, satynowa

COLOR BOX



| YATO  | Ø (mm) | L (mm) | B (mm) | D (mm) | S1 (mm) | S2 (mm) | PCS packing: |  |
|--|--------|--------|--------|--------|---------|---------|--------------|---|
| YT-0006 | 6 | 109 | 14.4 | 10.3 | 3.7 | 5.2 | 10 | 600 |
| YT-0007 | 7 | 119 | 16.2 | 11.3 | 3.8 | 5.2 | 10 | 600 |
| YT-0008 | 8 | 129 | 18.6 | 12.8 | 4.2 | 5.7 | 10 | 360 |
| YT-0009 | 9 | 139 | 20.7 | 14.1 | 4.3 | 6.4 | 10 | 360 |
| YT-0010 | 10 | 149 | 22.6 | 15.2 | 4.8 | 6.9 | 10 | 360 |
| YT-0011 | 11 | 159 | 24.6 | 16.8 | 5.2 | 7.4 | 10 | 360 |
| YT-0012 | 12 | 169 | 27.1 | 18.0 | 5.3 | 7.9 | 10 | 240 |
| YT-0013 | 13 | 179 | 28.7 | 19.8 | 6.0 | 8.6 | 10 | 240 |
| YT-0014 | 14 | 189 | 31.3 | 20.8 | 6.2 | 8.9 | 10 | 100 |
| YT-0015 | 15 | 199 | 33.2 | 22.3 | 6.6 | 9.2 | 10 | 100 |
| YT-0016 | 16 | 209 | 35.0 | 23.8 | 6.8 | 9.9 | 10 | 100 |
| YT-0017 | 17 | 219 | 37.5 | 25.0 | 7.0 | 10.9 | 10 | 100 |
| YT-0018 | 18 | 229 | 39.5 | 26.6 | 7.8 | 11.4 | 10 | 100 |
| YT-0019 | 19 | 239 | 41.3 | 28.0 | 8.0 | 12.1 | 10 | 100 |
| YT-0020 | 20 | 249 | 44.1 | 29.8 | 8.3 | 12.4 | 10 | 80 |
| YT-0021 | 21 | 259 | 46.1 | 30.8 | 8.6 | 12.7 | 10 | 80 |

| YATO  | Ø (mm) | L (mm) | B (mm) | D (mm) | S1 (mm) | S2 (mm) | PCS packing: |  |
|--|--------|--------|--------|--------|---------|---------|--------------|---|
| YT-0022 | 22 | 269 | 48.2 | 32.2 | 9.0 | 13.1 | 5 | 40 |
| YT-0023 | 23 | 279 | 49.8 | 33.6 | 9.2 | 13.4 | 5 | 40 |
| YT-0024 | 24 | 289 | 51.4 | 34.3 | 9.6 | 13.4 | 5 | 40 |
| YT-0025 | 25 | 299 | 54.6 | 36.8 | 9.8 | 14.2 | 5 | 40 |
| YT-0026 | 26 | 309 | 56.2 | 37.3 | 10.0 | 14.9 | 5 | 40 |
| YT-0027 | 27 | 319 | 58.7 | 39.6 | 10.4 | 16.4 | 5 | 30 |
| YT-0028 | 28 | 329 | 59.4 | 40.7 | 10.8 | 16.9 | 5 | 30 |
| YT-0030 | 30 | 349 | 63.0 | 43.3 | 11.3 | 18.4 | 5 | 30 |
| YT-0032 | 32 | 369 | 67.3 | 44.8 | 11.8 | 19.4 | 4 | 24 |
| YT-0036 | 36 | 435 | 74.0 | 53.5 | 13.8 | 19.5 | - | 5/10 |
| YT-0038 | 38 | 445 | 76.0 | 55.0 | 16.3 | 20.3 | - | 5/10 |
| YT-0041 | 41 | 475 | 83.7 | 61.6 | 16.3 | 20.3 | - | 2/8 |
| YT-0046 | 46 | 545 | 99.0 | 75.3 | 19.5 | 22.7 | - | 2/8 |
| YT-0050 | 50 | 545 | 99.5 | 76.0 | 19.5 | 22.7 | - | 2/8 |
| YT-0055 | 55 | 610 | 110.0 | 80.0 | 19.5 | 22.7 | - | 2/4 |

GB Combination spanner set
D Maulringschlüsselsatz
PL Komplet kluczy płasko-oczkowych
RUS Набор ключей комбинированных

CZ Souprava plochých a očkových klíčů
H Kulcskészlet, villás-csillag
RO Set cheie combinată

E Juego de combinadas con llave de estrella
CN 两用扳手手套

POUCH & COLOR BOX





DIN 3113
CrV 6140

AS-DRIVE





10
PCS
6, 7, 8, 10, 12, 13,
14, 15, 17, 19 mm

YATO 

YT-0060  20

12
PCS
8, 9, 10, 11, 12, 13, 14,
15, 17, 19, 22, 24 mm

YATO 

YT-0062  6



15
PCS
6, 7, 8, 10, 11, 12, 13, 14, 15,
17, 18, 19, 22, 24, 27 mm

YATO 

YT-0065  8

17
PCS
8, 9, 10, 11, 12, 13, 14, 15, 16, 17,
18, 19, 22, 24, 27, 30, 32 mm

YATO 

YT-0067  3



25
PCS
6, 7, 8, 9, 10, 11, 12, 13, 14,
15, 16, 17, 18, 19, 20, 21, 22,
23, 24, 25, 26, 27, 28, 30, 32 mm

YATO 

YT-0075  3

GB Combination spanner
D Maulringschlüssel
PL Klucz płasko-oczkowy
RUS Ключ комбинированный
CZ Plochý a oškový klič

H Kulcs villás-csillag
RO Cheie combinată
E Combinada con llave de estrella
CN 两用扳手

COLOR BOX



DIN 3113

CrV 6140

AS-DRIVE

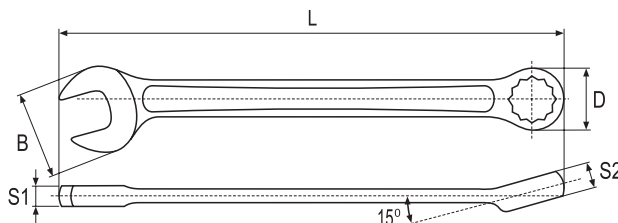

- application: industry
- head offset: 15°
- maximum torque exceeding DIN and ANSI standards by 60%
- surface finish: chromed, satin
- przeznaczenie: przemysł
- kąt odchylenia główek: 15°
- maksymalny moment obrotowy większy o 60% niż w standardach DIN i ANSI
- wykończenie powierzchni: chromowana, satynowa

| YATO | Ø (mm) | L (mm) | B (mm) | D (mm) | S1 (mm) | S2 (mm) | PCS packing: | |
|---------|--------|--------|--------|--------|---------|---------|--------------|-----|
| YT-5000 | 6 | 105 | 14.6 | 10.6 | 3.3 | 6.5 | 10 | 600 |
| YT-5001 | 7 | 116 | 16.5 | 11.6 | 3.5 | 6.2 | 10 | 600 |
| YT-5002 | 8 | 125 | 18.4 | 13.0 | 4.0 | 6.9 | 10 | 360 |
| YT-5003 | 9 | 132 | 20.5 | 14.5 | 4.0 | 7.5 | 10 | 360 |
| YT-5004 | 10 | 144 | 22.1 | 15.4 | 4.2 | 7.8 | 10 | 360 |
| YT-5005 | 11 | 152 | 24.4 | 16.8 | 4.8 | 8.4 | 10 | 360 |
| YT-5006 | 12 | 160 | 26.1 | 18.3 | 4.9 | 8.4 | 10 | 240 |
| YT-5007 | 13 | 170 | 28.6 | 19.9 | 5.3 | 9.1 | 10 | 240 |
| YT-5008 | 14 | 180 | 30.6 | 20.9 | 5.3 | 9.7 | 10 | 100 |
| YT-5009 | 15 | 193 | 33.6 | 22.6 | 5.5 | 10.0 | 10 | 100 |
| YT-5010 | 16 | 200 | 34.4 | 24.5 | 6.0 | 10.8 | 10 | 100 |
| YT-5012 | 18 | 215 | 38.8 | 26.5 | 6.8 | 11.6 | 10 | 100 |
| YT-5013 | 19 | 222 | 41.0 | 28.2 | 6.8 | 11.8 | 10 | 100 |

| YATO | Ø (mm) | L (mm) | B (mm) | D (mm) | S1 (mm) | S2 (mm) | PCS packing: | |
|---------|--------|--------|--------|--------|---------|---------|--------------|----|
| YT-5014 | 20 | 237 | 43.4 | 30.1 | 7.0 | 12.5 | 10 | 80 |
| YT-5015 | 21 | 243 | 45.2 | 31.1 | 7.3 | 13.1 | 10 | 80 |
| YT-5016 | 22 | 255 | 46.8 | 32.4 | 7.4 | 13.7 | 5 | 40 |
| YT-5017 | 23 | 267 | 49.3 | 34.3 | 7.7 | 13.8 | 5 | 40 |
| YT-5018 | 24 | 271 | 50.5 | 36.1 | 8.2 | 14.4 | 5 | 40 |
| YT-5019 | 25 | 286 | 53.2 | 37.1 | 8.4 | 14.9 | 5 | 40 |
| YT-5020 | 26 | 295 | 54.5 | 38.7 | 8.7 | 15.2 | 5 | 40 |
| YT-5021 | 27 | 305 | 56.7 | 40.0 | 8.7 | 16.5 | 5 | 30 |
| YT-5022 | 28 | 315 | 58.7 | 41.6 | 9.5 | 16.8 | 5 | 30 |
| YT-5023 | 29 | 328 | 60.4 | 42.5 | 9.2 | 17.5 | 5 | 30 |
| YT-5024 | 30 | 340 | 62.4 | 44.7 | 10.4 | 18.7 | 5 | 30 |
| YT-5025 | 32 | 357 | 66.5 | 47.2 | 10.5 | 20.3 | 4 | 24 |

GB Combination spanner
D Maulringschlüssel
PL Klucz płasko-oczkowy
RUS Ключ комбинированный
CZ Plochý a oškový klič

H Kulcs villás-csillag
RO Cheie combinată
E Combinada con llave de estrella
CN 两用扳手

S.A.E.

DIN 3113

CrV

AS-DRIVE

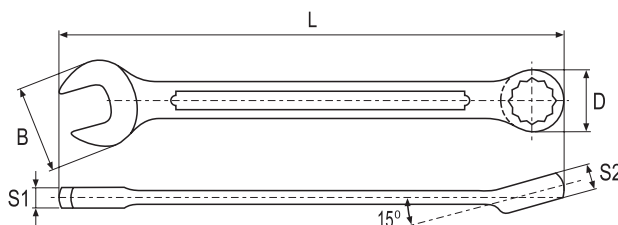

- application: workshop
- head offset: 15°
- surface finish: chromed, satin / mirror
- przeznaczenie: warsztat
- kąt odchylenia główek: 15°
- wykończenie powierzchni: chromowana, satynowa / polerowana

COLOR BOX



| YATO | Ø | L (mm) | B (mm) | D (mm) | S1 (mm) | S2 (mm) | PCS packing: | |
|---------|------------------|--------|--------|--------|---------|---------|--------------|---------|
| YT-4870 | 1/4" (6.3 mm) | 110 | 13.9 | 10.7 | 4.0 | 4.9 | 10 | 300/600 |
| YT-4871 | 5/16" (7.9 mm) | 130 | 17.6 | 12.8 | 4.6 | 5.7 | 10 | 180/360 |
| YT-4872 | 3/8" (9.5 mm) | 150 | 21.5 | 15.5 | 4.8 | 6.1 | 10 | 180/360 |
| YT-4873 | 7/16" (11.1 mm) | 160 | 23.8 | 17.0 | 5.1 | 6.7 | 10 | 180/360 |
| YT-4874 | 1/2" (12.7 mm) | 180 | 27.6 | 19.9 | 5.6 | 8.0 | 10 | 120/240 |
| YT-4875 | 9/16" (14.3 mm) | 190 | 29.6 | 21.6 | 6.1 | 8.1 | 10 | 120/240 |
| YT-4876 | 5/8" (15.9 mm) | 210 | 33.6 | 23.9 | 6.3 | 9.2 | 10 | 50/100 |
| YT-4877 | 11/16" (17.5 mm) | 230 | 37.8 | 26.3 | 6.7 | 10.8 | 10 | 50/100 |

| YATO | Ø | L (mm) | B (mm) | D (mm) | S1 (mm) | S2 (mm) | PCS packing: | |
|---------|-------------------|--------|--------|--------|---------|---------|--------------|--------|
| YT-4878 | 3/4" (19.0 mm) | 240 | 40.1 | 27.9 | 7.2 | 10.6 | 10 | 50/100 |
| YT-4879 | 13/16" (20.6 mm) | 260 | 43.2 | 31.1 | 7.6 | 10.8 | 10 | 40/80 |
| YT-4880 | 7/8" (22.2 mm) | 270 | 46.5 | 32.9 | 8.4 | 11.6 | 5 | 20/40 |
| YT-4881 | 15/16" (23.8 mm) | 290 | 50.2 | 34.9 | 8.7 | 12.0 | 5 | 20/40 |
| YT-4882 | 1" (25.4 mm) | 300 | 51.9 | 36.2 | 8.8 | 12.7 | 5 | 20/40 |
| YT-4883 | 1-1/16" (27.0 mm) | 320 | 56.0 | 38.9 | 9.3 | 13.6 | 5 | 15/30 |
| YT-4884 | 1-1/8" (28.6 mm) | 340 | 59.7 | 42.2 | 9.8 | 14.2 | 5 | 15/30 |
| YT-4885 | 1-1/4" (31.8 mm) | 370 | 65.5 | 46.2 | 10.9 | 15.6 | 5 | 10/20 |

GB Stubby combination spanner
D Maulringschlüssel
PL Kluczek płasko-oczkowy krótki
RUS Ключ комбинированный
CZ Plochý a očkový klíč
H Kulcs villás-csillag
RO Cheie combinată
E Combinada con llave de estrella
CN 两用扳手

COLOR BOX



CrV

AS-DRIVE

1

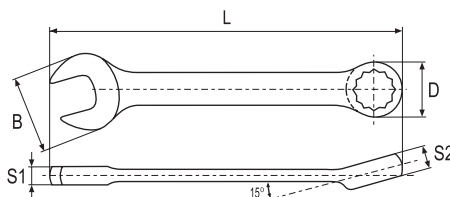

- application: workshop
- head offset: 15°
- surface finish: chromed

- przeznaczenie: warsztat
- kąt odchylenia główki: 15°
- wykończenie powierzchni: chromowana

| YATO | Ø (mm) | L (mm) | B (mm) | D (mm) | S1 (mm) | S2 (mm) | PCS packing: | |
|---------|--------|--------|--------|--------|---------|---------|--------------|---------|
| YT-4901 | 8 | 91 | 19.2 | 13.9 | 5.0 | 6.3 | 10 | 120/240 |
| YT-4902 | 9 | 97 | 21.7 | 16.4 | 5.4 | 6.4 | 10 | 120/240 |
| YT-4903 | 10 | 97 | 21.9 | 16.6 | 5.2 | 6.4 | 10 | 120/240 |
| YT-4904 | 11 | 100 | 23.2 | 18.3 | 5.9 | 7.2 | 10 | 120/240 |
| YT-4905 | 12 | 108 | 27.4 | 20.2 | 6.4 | 7.6 | 10 | 120/240 |
| YT-4906 | 13 | 109 | 27.9 | 20.7 | 6.7 | 7.7 | 10 | 120/240 |

| YATO | Ø (mm) | L (mm) | B (mm) | D (mm) | S1 (mm) | S2 (mm) | PCS packing: | |
|---------|--------|--------|--------|--------|---------|---------|--------------|--------|
| YT-4907 | 14 | 115 | 29.3 | 22.1 | 6.1 | 8.3 | 10 | 60/120 |
| YT-4908 | 15 | 120 | 31.2 | 24.0 | 6.8 | 9.6 | 10 | 60/120 |
| YT-4909 | 16 | 121 | 32.0 | 24.3 | 6.8 | 9.6 | 10 | 60/120 |
| YT-4910 | 17 | 128 | 36.6 | 27.1 | 7.4 | 9.9 | 10 | 60/120 |
| YT-4911 | 18 | 127 | 36.2 | 26.8 | 7.4 | 9.9 | 10 | 60/120 |
| YT-4912 | 19 | 135 | 39.2 | 29.5 | 8.8 | 10.8 | 10 | 60/120 |

GB Combination ratchet wrench
D Ratschenringmaulschlüssel
PL Kluczek płasko-oczkowy z grzechotką
RUS Ключ комбинированный с трещоткой
CZ Klíč očkoplochý ráčnový
H Csillag-villás kulcs racsnis
RO Cheie combinată cu crichet
E Llave combinada fija abierta y carraca
CN 两用扳手



72T

CrV
6140

AS-DRIVE

- application: service
- 72 teeth ratchet
- minimum operation angle: 5°
- surface finish: chromed, mirror

- przeznaczenie: serwis
- grzechotka 72 zęby
- minimalny kąt pracy: 5°
- wykończenie powierzchni: chromowana, polerowana

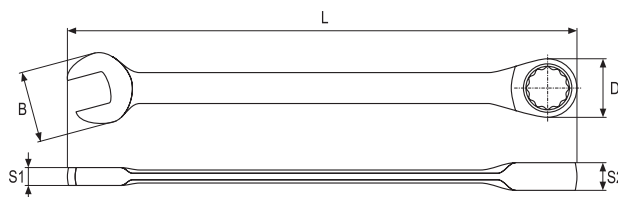

PLASTIC HANGER



COLOR BOX



| YATO | Ø (mm) | L (mm) | B (mm) | D (mm) | S1 (mm) | S2 (mm) | PCS packing: | |
|---------|--------|--------|--------|--------|---------|---------|--------------|--------|
| YT-0191 | 10 | 160 | 22.1 | 22.2 | 6.0 | 7.8 | 10 | 50/100 |
| YT-0192 | 11 | 165 | 24.7 | 24.2 | 6.6 | 8.5 | 10 | 50/100 |
| YT-0193 | 12 | 170 | 26.4 | 25.5 | 6.7 | 8.9 | 10 | 50/100 |
| YT-0194 | 13 | 180 | 27.5 | 26.7 | 6.6 | 9.2 | 10 | 50/100 |
| YT-0195 | 14 | 190 | 30.8 | 29.0 | 7.4 | 9.4 | 10 | 50/100 |
| YT-0196 | 15 | 200 | 32.9 | 30.8 | 7.7 | 10.1 | 10 | 50/100 |
| YT-0197 | 16 | 210 | 34.3 | 31.5 | 7.8 | 10.3 | 10 | 50/100 |
| YT-0198 | 17 | 225 | 36.8 | 33.6 | 8.4 | 10.6 | 10 | 50/100 |
| YT-0199 | 18 | 235 | 39.2 | 35.6 | 9.1 | 10.8 | 10 | 50/100 |

| YATO | Ø (mm) | L (mm) | B (mm) | D (mm) | S1 (mm) | S2 (mm) | PCS packing: | |
|---------|--------|--------|--------|--------|---------|---------|--------------|--------|
| YT-0200 | 19 | 245 | 40.1 | 37.3 | 9.5 | 11.3 | 10 | 50/100 |
| YT-0189 | 21 | 290 | 45.2 | 43.0 | 9.9 | 13.3 | 6 | 30/60 |
| YT-0201 | 22 | 290 | 45.6 | 44.2 | 10.5 | 13.4 | 6 | 24/48 |
| YT-0202 | 24 | 335 | 52.8 | 50.0 | 11.3 | 14.5 | 6 | 48 |
| YT-0203 | 25 | 335 | 52.0 | 47.4 | 10.2 | 14.3 | 6 | 30 |
| YT-0204 | 27 | 355 | 55.6 | 52.7 | 10.9 | 15.7 | 6 | 30 |
| YT-0205 | 30 | 400 | 62.5 | 57.7 | 12.2 | 17.1 | 6 | 24 |
| YT-0206 | 32 | 420 | 65.0 | 61.7 | 13.2 | 17.9 | 6 | 24 |

GB Combination ratchet wrench set
D Knarrenringmaulschlüssel-satz
PL Komplet kluczy płasko-oczkowych z grzechotką
RUS Набор комбинированных ключей с трещоткой
CZ Klíče ráčnové sada
H Racsnis csillag-villás kulcs készlet
RO Set chei combinate
E Juego de llaves planas con matraca
CN 扳手组套



7
PCS

CrV
6140

72T



AS-DRIVE

10, 12, 13, 14, 15, 17, 19 mm

PLASTIC HANGER

| YATO | PCS packing: | |
|---------|--------------|--|
| YT-0208 | 10/20 | |

- GB Combination ratchet wrench
- D Ratschenringmaulschlüssel
- PL Klucz płasko-oczkowy z grzechotką
- RUS Ключ комбинированный с трещоткой
- CZ Klíč oškoplochý ráčňový
- H Csillag-villás kulcs racsnis
- RO Cheie combinata cu crichet
- E Llave combinada fija abierta y carraca
- CN 棘轮两用扳手

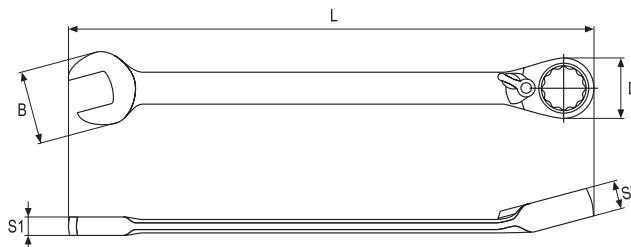

| YATO | Ø (mm) | L (mm) | B (mm) | D (mm) | S1 (mm) | S2 (mm) | PCS packing | |
|---------|--------|--------|--------|--------|---------|---------|-------------|--------|
| YT-1651 | 8 | 140 | 17.5 | 19.0 | 6.0 | 7.2 | 10 | 50/100 |
| YT-1652 | 9 | 150 | 19.8 | 20.7 | 6.4 | 7.5 | 10 | 50/100 |
| YT-1653 | 10 | 160 | 22.1 | 23.1 | 6.4 | 7.9 | 10 | 50/100 |
| YT-1654 | 11 | 165 | 23.9 | 25.0 | 6.6 | 8.4 | 10 | 50/100 |
| YT-1655 | 12 | 170 | 27.1 | 26.0 | 6.5 | 8.9 | 10 | 50/100 |
| YT-1656 | 13 | 180 | 27.9 | 27.6 | 7.1 | 9.1 | 10 | 50/100 |
| YT-1657 | 14 | 190 | 31.6 | 28.3 | 7.3 | 9.5 | 10 | 50/100 |
| YT-1658 | 15 | 200 | 32.8 | 31.4 | 8.1 | 9.8 | 10 | 50/100 |
| YT-1659 | 16 | 210 | 33.9 | 32.9 | 8.4 | 10.3 | 10 | 50/100 |
| YT-1660 | 17 | 225 | 38.0 | 34.5 | 8.7 | 10.5 | 10 | 50/100 |
| YT-1661 | 18 | 235 | 39.8 | 36.9 | 9.3 | 10.7 | 10 | 50/100 |
| YT-1662 | 19 | 245 | 41.8 | 38.3 | 9.5 | 11.3 | 10 | 50/100 |

| YATO | Ø (mm) | L (mm) | B (mm) | D (mm) | S1 (mm) | S2 (mm) | PCS packing | |
|---------|--------|--------|--------|--------|---------|---------|-------------|-------|
| YT-1663 | 20 | 245 | 41.9 | 38.1 | 9.7 | 11.4 | 6 | 30/60 |
| YT-1664 | 21 | 290 | 44.9 | 43.0 | 9.8 | 13.6 | 6 | 30/60 |
| YT-1665 | 22 | 290 | 44.8 | 43.8 | 10.0 | 13.6 | 6 | 30/60 |
| YT-1666 | 23 | 290 | 44.9 | 43.3 | 10.3 | 13.7 | 6 | 24/48 |
| YT-1667 | 24 | 330 | 52.0 | 49.4 | 10.2 | 14.5 | 6 | 24/48 |
| YT-1668 | 25 | 330 | 53.0 | 49.6 | 10.6 | 14.7 | 6 | 24/48 |
| YT-1669 | 26 | 360 | 56.3 | 53.6 | 12.1 | 15.7 | 6 | 30 |
| YT-1670 | 27 | 360 | 55.6 | 52.9 | 12.2 | 16.1 | 6 | 30 |
| YT-1671 | 28 | 360 | 56.1 | 53.6 | 12.6 | 16.0 | 6 | 24 |
| YT-1672 | 30 | 400 | 62.1 | 58.0 | 11.9 | 17.2 | 6 | 24 |
| YT-1673 | 32 | 420 | 64.1 | 62.0 | 12.9 | 17.7 | 6 | 24 |

- GB Combination ratchet wrench
- D Ratschenringmaulschlüssel
- PL Klucz płasko-oczkowy z grzechotką
- RUS Ключ комбинированный с трещоткой
- CZ Klíč oškoplochý ráčňový
- H Csillag-villás kulcs racsnis
- RO Cheie combinata cu crichet
- E Llave combinada fija abierta y carraca
- CN 防滑棘轮两用扳手

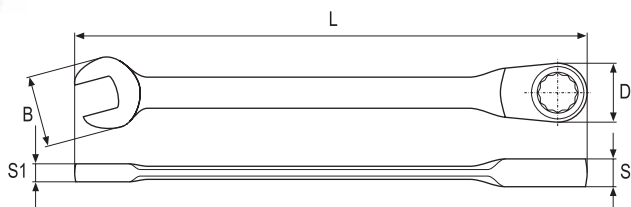

- application: industry
- 72 teeth ratchet
- minimum operation angle: 5°
- NON-SLIP system
- allows to unscrew 70% damaged hex screws
- surface finish: chromed, satin
- przeznaczenie: przemysł
- grzechotka 72 zęby
- minimalny kąt pracy: 5°
- system NON-SLIP
- umożliwia odkręcanie śrub sześciokątnych zniszczonych w 70%
- wykończenie powierzchni: chromowana, satynowa



| YATO | Ø (mm) | L (mm) | B (mm) | D (mm) | S1 (mm) | S2 (mm) | |
|---------|--------|--------|--------|--------|---------|---------|--------|
| YT-0256 | 11 | 163 | 22.8 | 22.1 | 6.0 | 8.5 | 10/100 |
| YT-0263 | 18 | 239 | 38.6 | 31.9 | 8.3 | 11.5 | 10/100 |
| YT-0264 | 19 | 250 | 39.0 | 33.6 | 8.7 | 11.5 | 10/100 |

- GB Rapid combination ratchet wrench
- D Ratschenringmaulschlüssel
- PL Klucz „szybki” z grzechotką
- RUS Ключ комбинированный с трещоткой
- CZ Klíč očkoploché ráčnový
- H Csillag-villás kulcs racsnis
- RO Cheie combinata cu crichet
- E Llave combinada fija abierta y carraca
- CN 棘轮两用扳手

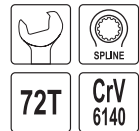
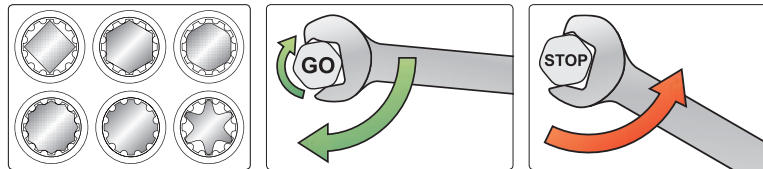

- application: industry
- 72 teeth ratchet
- minimum operation angle: 5°
- spline profile serves for 5 types of nuts
- surface finish: chromed, mirror
- przeznaczenie: przemysł
- grzechotka 72 zęby
- minimalny kąt pracy: 5°
- profil Spline – obsługuje 5 rodzajów nakrętek
- wykończenie powierzchni: chromowana, polerowana

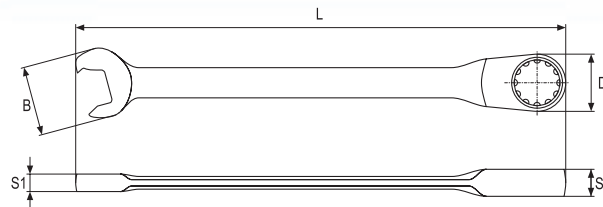

PLASTIC HANGER

| YATO | Ø (mm) | L (mm) | B (mm) | D (mm) | S1 (mm) | S2 (mm) | |
|---------|--------|--------|--------|--------|---------|---------|--------|
| YT-0155 | 8 | 144 | 15.35 | 17.70 | 4.96 | 7.28 | 10/100 |
| YT-0156 | 9 | 150 | 16.65 | 19.40 | 4.65 | 7.28 | 10/100 |
| YT-0158 | 11 | 165 | 20.32 | 21.55 | 5.70 | 8.20 | 10/100 |
| YT-0159 | 12 | 173 | 22.47 | 23.24 | 6.00 | 8.20 | 10/100 |
| YT-0160 | 13 | 182 | 23.88 | 24.80 | 6.70 | 8.20 | 10/100 |

| YATO | Ø (mm) | L (mm) | B (mm) | D (mm) | S1 (mm) | S2 (mm) | |
|---------|--------|--------|--------|--------|---------|---------|--------|
| YT-0161 | 14 | 190 | 26.60 | 25.90 | 6.70 | 8.20 | 10/100 |
| YT-0162 | 15 | 202 | 27.80 | 27.55 | 7.30 | 8.20 | 10/100 |
| YT-0163 | 16 | 215 | 30.20 | 28.55 | 7.55 | 9.92 | 10/100 |
| YT-0164 | 17 | 229 | 31.80 | 30.15 | 7.90 | 9.85 | 10/100 |
| YT-0165 | 19 | 252 | 35.45 | 34.00 | 8.65 | 11.50 | 10/100 |

- GB Flexible ratchet combination wrench
- D Ratschenringmaulschlüssel
- PL Klucz płasko-oczkowy z grzechotką i przegubem
- RUS Ключ комбинированный с трещоткой
- CZ Klíč očkoploché ráčnový
- H Csillag-villás kulcs racsnis
- RO Cheie combinata cu crichet
- E Llave combinada fija abierta y carraca
- CN 活头棘轮两用扳手

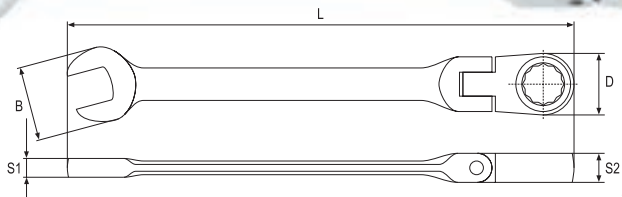

PLASTIC HANGER

PCS packing:

COLOR BOX

| YATO | Ø (mm) | L (mm) | B (mm) | D (mm) | S1 (mm) | S2 (mm) | PCS packing: | |
|---------|--------|--------|--------|--------|---------|---------|--------------|--------|
| YT-1674 | 8 | 140 | 18.0 | 19.6 | 6.3 | 7.3 | 10 | 50/100 |
| YT-1675 | 9 | 145 | 19.7 | 21.1 | 4.7 | 7.6 | 10 | 50/100 |
| YT-1676 | 10 | 160 | 22.8 | 23.2 | 6.3 | 7.8 | 10 | 50/100 |
| YT-1677 | 11 | 160 | 24.0 | 24.7 | 5.4 | 8.5 | 10 | 50/100 |
| YT-1678 | 12 | 170 | 26.4 | 26.7 | 6.8 | 8.8 | 10 | 50/100 |
| YT-1679 | 13 | 180 | 28.4 | 27.3 | 7.2 | 9.1 | 10 | 50/100 |
| YT-1680 | 14 | 185 | 29.5 | 28.7 | 6.8 | 9.4 | 10 | 50/100 |
| YT-1681 | 15 | 195 | 32.9 | 30.8 | 7.2 | 9.8 | 10 | 50/100 |
| YT-1682 | 16 | 210 | 34.4 | 33.3 | 7.6 | 10.3 | 10 | 50/100 |
| YT-1683 | 17 | 230 | 36.7 | 35.7 | 8.3 | 10.5 | 10 | 50/100 |
| YT-1684 | 18 | 235 | 39.0 | 35.9 | 8.0 | 10.8 | 10 | 50/100 |
| YT-1685 | 19 | 245 | 40.8 | 37.6 | 9.5 | 11.2 | 10 | 50/100 |

| YATO | Ø (mm) | L (mm) | B (mm) | D (mm) | S1 (mm) | S2 (mm) | PCS packing: | |
|---------|--------|--------|--------|--------|---------|---------|--------------|-------|
| YT-1686 | 20 | 245 | 40.9 | 38.2 | 8.8 | 11.1 | 6 | 30/60 |
| YT-1687 | 21 | 290 | 45.0 | 42.8 | 9.8 | 13.6 | 6 | 30/60 |
| YT-1688 | 22 | 290 | 45.2 | 42.7 | 9.8 | 13.5 | 6 | 30/60 |
| YT-1689 | 23 | 290 | 45.3 | 42.8 | 9.6 | 13.6 | 6 | 24/48 |
| YT-1690 | 24 | 330 | 51.3 | 48.7 | 10.4 | 14.5 | 6 | 24/48 |
| YT-1691 | 25 | 330 | 51.4 | 48.4 | 10.6 | 14.5 | 6 | 24/48 |
| YT-1692 | 26 | 360 | 56.6 | 53.6 | 11.6 | 15.7 | 6 | 30 |
| YT-1693 | 27 | 360 | 56.7 | 53.2 | 11.7 | 15.8 | 6 | 30 |
| YT-1694 | 28 | 360 | 56.4 | 53.5 | 11.0 | 15.8 | 6 | 24 |
| YT-1695 | 30 | 410 | 61.6 | 58.7 | 12.4 | 17.2 | 6 | 24 |
| YT-1696 | 32 | 430 | 64.7 | 63.3 | 12.8 | 17.8 | 6 | 24 |

- GB Flexible ratchet combination wrench
- D Ratschenringmaulschlüssel
- PL Klucz płasko-oczkowy z grzechotką i przegubem
- RUS Ключ комбинированный с трещоткой
- CZ Klíč očkoploché ráčnový
- H Csillag-villás kulcs racsnis
- RO Cheie combinata cu crichet
- E Llave combinada fija abierta y carraca
- CN 活头棘轮两用扳手

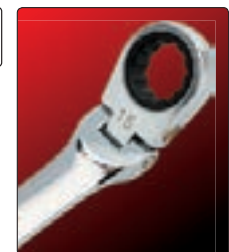

- application: industry
- 72 teeth ratchet
- minimum operation angle: 5°
- articulated joint for ring head
- surface finish: chromed, mirror
- przeznaczenie: przemysł
- grzechotka 72 zęby
- minimalny kąt pracy: 5°
- przegub przy główce oczkowej
- wykończenie powierzchni: chromowana, polerowana

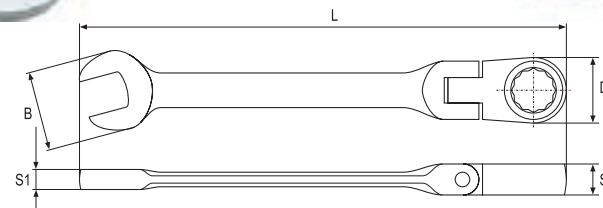

PLASTIC HANGER

| YATO | Ø (mm) | L (mm) | B (mm) | D (mm) | S1 (mm) | S2 (mm) | |
|---------|--------|--------|--------|--------|---------|---------|--------|
| YT-0271 | 10 | 133 | 21.9 | 21.0 | 5.8 | 8.4 | 10/100 |
| YT-0272 | 11 | 139 | 22.8 | 22.0 | 6.0 | 8.4 | 10/100 |
| YT-0273 | 12 | 144 | 25.3 | 23.6 | 6.0 | 8.4 | 10/100 |
| YT-0274 | 13 | 152 | 27.1 | 24.9 | 6.6 | 8.4 | 10/100 |
| YT-0276 | 15 | 167 | 31.6 | 27.7 | 7.4 | 8.4 | 10/100 |

| YATO | Ø (mm) | L (mm) | B (mm) | D (mm) | S1 (mm) | S2 (mm) | |
|---------|--------|--------|--------|--------|---------|---------|--------|
| YT-0277 | 16 | 177 | 33.7 | 29.1 | 7.6 | 10.0 | 10/100 |
| YT-0278 | 17 | 187 | 37.0 | 30.5 | 8.0 | 10.0 | 10/100 |
| YT-0279 | 18 | 201 | 39.0 | 31.7 | 8.4 | 11.5 | 10/100 |
| YT-0280 | 19 | 213 | 39.7 | 34.2 | 8.5 | 11.5 | 10/100 |

1

- GB Double open end spanner
- D Doppelmaulschlüssel
- PL Klucz płaski
- RUS Ключ рожковый
- CZ Plochý klič
- H Villáskulcs
- RO Cheie fixă
- E Llave fija
- CN 双头呆扳手

DIN 3110 CrV

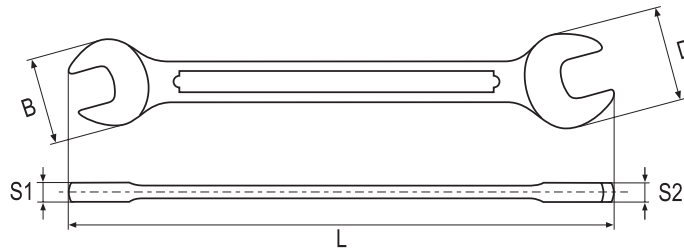

- surface finish:
chromed, satin / mirror
- wykończenie powierzchni:
chromowana, satynowa / polerowana



COLOR BOX

| YATO | Ø (mm) | L (mm) | B (mm) | D (mm) | S1 (mm) | S2 (mm) | PCS packing | |
|---------|--------|--------|--------|--------|---------|---------|-------------|---------|
| YT-0367 | 6x7 | 120 | 15.1 | 16.8 | 3.5 | 3.6 | 10 | 360/720 |
| YT-0368 | 8x9 | 140 | 18.7 | 20.8 | 3.7 | 3.6 | 10 | 180/360 |
| YT-0369 | 10x11 | 155 | 22.4 | 25.5 | 4.6 | 4.6 | 10 | 150/300 |
| YT-0332 | 10x13 | 170 | 22.5 | 29.3 | 4.6 | 5.3 | 10 | 150/300 |
| YT-0370 | 12x13 | 170 | 27.1 | 29.3 | 4.9 | 5.3 | 10 | 80/160 |
| YT-0333 | 13x17 | 180 | 29.3 | 37.5 | 5.3 | 6.3 | 10 | 50/100 |
| YT-0371 | 14x15 | 180 | 31.0 | 33.0 | 5.3 | 5.4 | 10 | 80/160 |
| YT-0372 | 16x17 | 200 | 34.9 | 37.5 | 6.5 | 6.3 | 10 | 50/100 |

| YATO | Ø (mm) | L (mm) | B (mm) | D (mm) | S1 (mm) | S2 (mm) | PCS packing | |
|---------|--------|--------|--------|--------|---------|---------|-------------|--------|
| YT-0334 | 17x19 | 220 | 37.5 | 38.7 | 6.3 | 6.3 | 10 | 50/100 |
| YT-0373 | 18x19 | 220 | 38.7 | 41.0 | 6.6 | 6.3 | 10 | 50/100 |
| YT-0374 | 20x22 | 230 | 42.1 | 46.8 | 7.1 | 6.8 | 10 | 30/60 |
| YT-0375 | 21x23 | 245 | 44.4 | 48.6 | 7.3 | 6.9 | 10 | 30/60 |
| YT-0376 | 24x27 | 260 | 51.6 | 56.9 | 8.1 | 8.1 | 5 | 20/40 |
| YT-0377 | 25x28 | 270 | 52.3 | 57.9 | 8.4 | 8.3 | 5 | 20/40 |
| YT-0378 | 30x32 | 295 | 61.4 | 65.1 | 8.0 | 8.6 | 5 | 15/30 |

- GB Double open end spanner set
- D Doppelmaulschlüsselsatz
- PL Komplet kluczy płaskich
- RUS Набор рожковых ключей
- CZ Souprava plochých kličů
- H Kulcskészlet, villás
- RO Set chei fixe
- E Juego de llaves fijas
- CN 双头呆扳手组套

POUCH & COLOR BOX



DIN 3110

CrV



10 PCS
6x7, 8x9, 10x11, 12x13, 14x15, 16x17, 18x19, 20x22, 21x23, 24x27 mm

12 PCS
6x7, 8x9, 10x11, 12x13, 14x15, 16x17, 18x19, 20x22, 21x23, 24x27, 25x28, 30x32 mm

| | | |
|---------|---|--|
| YATO | | |
| YT-0380 | 6 | |

| | | |
|---------|---|--|
| YATO | | |
| YT-0381 | 8 | |

DIN 3110 CrV 6140

1

- GB Double open end spanner
- D Doppelmaulschlüssel
- PL Klucz płaski
- RUS Ключ рожковый
- CZ Plochý klíč
- H Villáskulcs
- RO Cheie fixă
- E Llave fija
- CN 双头呆扳手

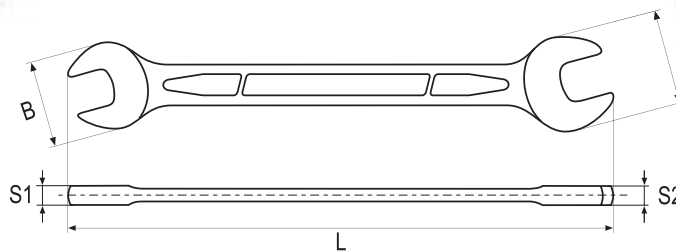

- surface finish:
chromed, satin
- wykończenie powierzchni:
chromowana, satynowa

COLOR BOX



| YATO | Ø (mm) | L (mm) | B (mm) | D (mm) | S1 (mm) | S2 (mm) | PCS packing | |
|---------|--------|--------|--------|--------|---------|---------|-------------|-----|
| YT-0107 | 6x7 | 128 | 15.5 | 17.5 | 3.8 | 3.8 | 10 | 600 |
| YT-0109 | 8x9 | 146 | 19.4 | 21.4 | 4.3 | 4.3 | 10 | 360 |
| YT-0110 | 8x10 | 146 | 19.4 | 21.4 | 4.3 | 4.3 | 10 | 360 |
| YT-0111 | 10x11 | 162 | 23.5 | 25.7 | 5.0 | 5.0 | 10 | 360 |
| YT-0112 | 10x13 | 175 | 27.7 | 30.2 | 5.3 | 5.3 | 10 | 120 |
| YT-0113 | 12x13 | 175 | 27.7 | 30.2 | 5.3 | 5.3 | 10 | 120 |
| YT-0115 | 14x15 | 191 | 31.7 | 33.7 | 5.8 | 5.8 | 10 | 120 |
| YT-0117 | 13x17 | 195 | 31.7 | 38.7 | 6.2 | 6.2 | 10 | 120 |
| YT-0118 | 16x17 | 212 | 36.2 | 38.2 | 6.3 | 6.3 | 10 | 100 |

| YATO | Ø (mm) | L (mm) | B (mm) | D (mm) | S1 (mm) | S2 (mm) | PCS packing | |
|---------|--------|--------|--------|--------|---------|---------|-------------|-----|
| YT-0119 | 17x19 | 224 | 40.2 | 42.2 | 6.8 | 6.8 | 10 | 100 |
| YT-0120 | 18x19 | 224 | 40.2 | 42.2 | 6.8 | 6.8 | 10 | 100 |
| YT-0122 | 19x22 | 237 | 44.2 | 48.2 | 7.5 | 7.5 | 10 | 60 |
| YT-0123 | 20x22 | 237 | 44.2 | 48.2 | 7.5 | 7.5 | 10 | 60 |
| YT-0125 | 21x23 | 247 | 46.2 | 50.2 | 7.8 | 7.8 | 10 | 60 |
| YT-0127 | 24x27 | 268 | 53.2 | 57.7 | 8.4 | 8.4 | 5 | 40 |
| YT-0128 | 25x28 | 268 | 53.2 | 57.7 | 8.4 | 8.4 | 5 | 40 |
| YT-0132 | 30x32 | 295 | 64.2 | 68.2 | 9.4 | 9.4 | 5 | 40 |

- GB Double open end spanner set
- D Doppelmaulschlüsselsatz
- PL Komplet kluczy płaskich

- RUS Набор рожковых ключей
- CZ Souprava plochých klíčů
- H Kulcskészlet, villás

- RO Set cheie fixe
- E Juego de llaves fijas
- CN 双头呆扳手组套

POUCH & COLOR BOX



DIN 3110

CrV 6140



10 PCS 6x7, 8x9, 10x11, 12x13, 14x15, 16x17, 18x19, 20x22, 21x23, 24x27 mm

12 PCS 6x7, 8x9, 10x11, 12x13, 14x15, 16x17, 18x19, 20x22, 21x23, 24x27, 25x28, 30x32 mm

| YATO | | |
|---------|---|--|
| YT-0150 | 6 | |

| YATO | | |
|---------|---|--|
| YT-0152 | 8 | |

- GB Double open end spanner
- D Doppelmaulschlüssel
- PL Klucz płaski
- RUS Ключ рожковый
- CZ Plochý klíč
- H Villáskulcs
- RO Cheie fixă
- E Llave fija
- CN 双头呆扳手

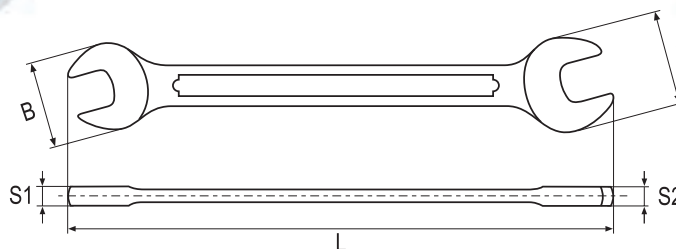

- surface finish:
chromed, satin / mirror
- wykończenie powierzchni:
chromowana, satynowa / polerowana

S.A.E. DIN 3110 CrV

COLOR BOX



| YATO | Ø | L (mm) | B (mm) | D (mm) | S1 (mm) | S2 (mm) | PCS packing | |
|---------|-----------------------------------|--------|--------|--------|---------|---------|-------------|---------|
| YT-4830 | 1/4" (6.3 mm) x 5/16" (7.9 mm) | 120 | 14.8 | 17.2 | 3.9 | 3.9 | 10 | 150/300 |
| YT-4831 | 3/8" (9.5 mm) x 7/16" (11.1 mm) | 155 | 22.0 | 25.1 | 4.8 | 4.8 | 10 | 150/300 |
| YT-4832 | 1/2" (12.7 mm) x 9/16" (14.3 mm) | 185 | 31.2 | 33.4 | 5.8 | 5.8 | 10 | 80/160 |
| YT-4833 | 5/8" (15.9 mm) x 11/16" (17.5 mm) | 200 | 34.6 | 37.2 | 6.0 | 6.1 | 10 | 50/100 |

| YATO | Ø | L (mm) | B (mm) | D (mm) | S1 (mm) | S2 (mm) | PCS packing | |
|---------|-------------------------------------|--------|--------|--------|---------|---------|-------------|--------|
| YT-4834 | 11/16" (17.5 mm) x 3/4" (19.0 mm) | 220 | 38.7 | 41.2 | 7.0 | 7.0 | 10 | 50/100 |
| YT-4835 | 13/16" (20.6 mm) x 7/8" (22.2 mm) | 235 | 42.7 | 47.0 | 7.0 | 7.0 | 10 | 20/40 |
| YT-4836 | 15/16" (23.8 mm) x 1" (25.4 mm) | 260 | 51.5 | 56.5 | 8.3 | 8.4 | 5 | 10 |
| YT-4837 | 1-1/8" (28.6 mm) x 1-1/4" (31.8 mm) | 295 | 62.6 | 66.2 | 8.6 | 8.7 | 5 | 10 |

1

GB Double ratchet spanner
 D Ringschlüsselsatz
 PL Klucz oczkowy z grzechotką
 RUS Ключ накидной
 CZ Očkový klíč

H Csillagkulcs
 RO Cheie inelare
 E Llave de anillo
 CN 双头梅花棘轮扳手



CrV
6140

72T

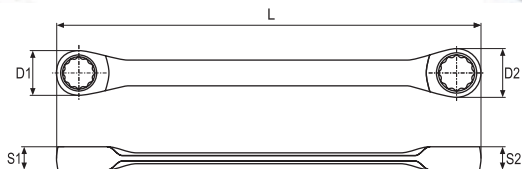

| YATO | Ø (mm) | L (mm) | D1 (mm) | D2 (mm) | S1 (mm) | S2 (mm) | PCS packing | Box |
|---------|--------|--------|---------|---------|---------|---------|-------------|---------|
| YT-5030 | 8x9 | 125 | 18.4 | 20.2 | 7.2 | 7.5 | 5 | 100/200 |
| YT-5031 | 10x11 | 150 | 21.9 | 23.9 | 8.0 | 8.5 | 5 | 100/200 |
| YT-5032 | 12x13 | 170 | 25.4 | 26.5 | 8.9 | 9.0 | 5 | 100/200 |
| YT-5033 | 14x15 | 190 | 27.7 | 29.6 | 9.5 | 9.8 | 5 | 50/100 |
| YT-5035 | 17x19 | 235 | 32.5 | 35.7 | 10.5 | 11.8 | 5 | 50/100 |

GB Double ratchet spanner set
 D Ringschlüsselsatz
 PL Klucze oczkowe z grzechotką
 RUS Набор ключей накидных
 CZ Očkové klíče

H Csillagkulcs készlet
 RO Set chei inelare
 E Llaves de anillo
 CN 双头梅花棘轮扳手组套

5
PCS



CrV
6140

72T



PLASTIC HANGER

8x9, 10x11, 12x13, 14x15, 17x19 mm

| YATO | Box |
|---------|-------|
| YT-5038 | 10/30 |

GB Bi-hexagonal ring spanner
 D Doppelringschlüssel
 PL Klucz oczkowy odgięty
 RUS Ключ накидной изогнутый
 CZ Očkový klíč ohnutý

H Hajlítotaszárú csillagkulcs
 RO Cheie inelare-curbată
 E Llave de estrella
 CN 双头高颈梅花扳手

DIN
838

CrV

AS-DRIVE

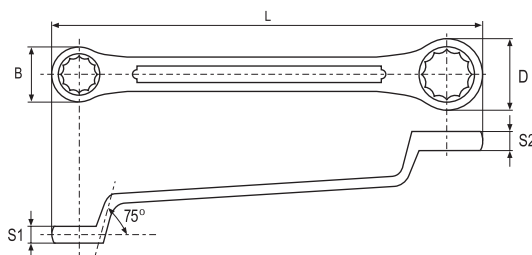

- application: industry
- surface finish: chromed, satin / mirror
- przeznaczenie: przemysł
- wykończenie powierzchni: chromowana, satynowa / polerowana



COLOR BOX

| YATO | Ø (mm) | L (mm) | B (mm) | D (mm) | S1 (mm) | S2 (mm) | PCS packing | Box |
|---------|--------|--------|--------|--------|---------|---------|-------------|---------|
| YT-0383 | 6x7 | 165 | 11.0 | 12.7 | 5.4 | 5.5 | 10 | 200/400 |
| YT-0384 | 8x9 | 185 | 13.9 | 15.5 | 6.8 | 7.2 | 10 | 100/200 |
| YT-0385 | 10x11 | 200 | 16.3 | 17.6 | 6.8 | 7.2 | 10 | 100/200 |
| YT-0386 | 12x13 | 220 | 19.6 | 21.5 | 7.2 | 7.7 | 10 | 60/120 |
| YT-0387 | 14x15 | 230 | 23.6 | 21.9 | 8.9 | 9.1 | 10 | 50/100 |
| YT-0388 | 16x17 | 255 | 24.6 | 26.4 | 8.6 | 9.3 | 10 | 30/60 |

| YATO | Ø (mm) | L (mm) | B (mm) | D (mm) | S1 (mm) | S2 (mm) | PCS packing | Box |
|---------|--------|--------|--------|--------|---------|---------|-------------|-------|
| YT-0389 | 18x19 | 270 | 27.5 | 28.8 | 10.5 | 10.2 | 5 | 25/50 |
| YT-0390 | 20x22 | 290 | 30.9 | 33.4 | 10.5 | 11.4 | 5 | 20/40 |
| YT-0391 | 21x23 | 310 | 31.9 | 34.4 | 11.8 | 12.4 | 5 | 20/40 |
| YT-0392 | 24x27 | 330 | 36.2 | 40.6 | 11.5 | 13.2 | 5 | 20/40 |
| YT-0394 | 30x32 | 390 | 44.0 | 47.1 | 13.8 | 14.9 | 3 | 15/30 |

GB Bi-hexagonal ring spanner set
D Doppelringschlüsselsatz
PL Komplet kluczy oczkowych odgiętych

RUS Набор ключей накидных изогнутых
CZ Klíče očkové vyhnuté sada
H Csillagkulcs készlet

RO Set chei inelare cu cot
E Juego de llaves de estrella acodadas
CN 双头高颈梅花扳手组套

POUCH
& COLOR
BOX



DIN
838

CrV

AS-DRIVE



8
PCS 6x7, 8x9, 10x11, 12x13, 14x15,
16x17, 18x19, 20x22 mm

YATO
YT-0396 6

12
PCS 6x7, 8x9, 10x11, 12x13, 14x15,
16x17, 18x19, 20x22, 21x23, 24x27,
25x28, 30x32 mm

YATO
YT-0398 4

GB Bi-hexagonal ring spanner
D Doppelringschlüssel
PL Klucz oczkowy odgięty
RUS Ключ накидной изогнутый
CZ Očkový klíč ohnutý
H Hajlítotszárú csillagkulcs
RO Cheie inelaro-curbată
E Llave de estrella
CN 双头高颈梅花扳手

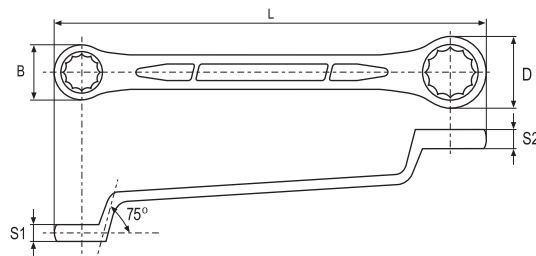

- application: industry
- surface finish: chromed, satin
- przeznaczenie: przemysł
- wykończenie powierzchni: chromowana, satynowa

COLOR BOX



| YATO | Ø (mm) | L (mm) | B (mm) | D (mm) | S1 (mm) | S2 (mm) | PCS packing | |
|----------|--------|--------|--------|--------|---------|---------|-------------|----|
| YT-02330 | 32x36 | 408 | 52 | 46 | 17.5 | 17.5 | 5 | 20 |
| YT-02331 | 36x41 | 448 | 58 | 52 | 18.0 | 18.0 | 5 | 20 |
| YT-02332 | 41x46 | 483 | 65 | 58 | 18.5 | 18.5 | 5 | 15 |

| YATO | Ø (mm) | L (mm) | B (mm) | D (mm) | S1 (mm) | S2 (mm) | PCS packing | |
|----------|--------|--------|--------|--------|---------|---------|-------------|----|
| YT-02333 | 46x50 | 495 | 71 | 65 | 19.0 | 19.0 | 5 | 10 |
| YT-02334 | 50x55 | 538 | 78 | 71 | 19.5 | 19.5 | 5 | 10 |

GB Bi-hexagonal ring spanner
D Doppelringschlüssel
PL Klucz oczkowy odgięty
RUS Ключ накидной изогнутый
CZ Očkový klíč ohnutý
H Hajlítotszárú csillagkulcs
RO Cheie inelaro-curbată
E Llave de estrella
CN 双头高颈梅花扳手

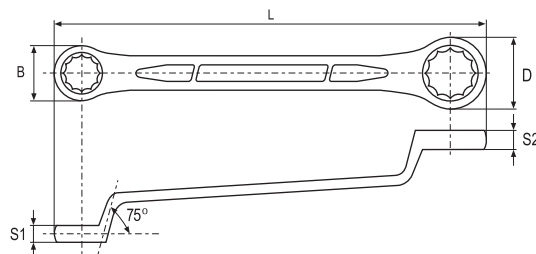

- application: industry
- maximum torque exceeding DIN and ANSI standards by 60%
- surface finish: chromed, satin
- przeznaczenie: przemysł
- maksymalny moment obrotowy większy o 60% niż w standardach DIN i ANSI
- wykończenie powierzchni: chromowana, satynowa

DIN
838

CrV
6140

AS-DRIVE

COLOR BOX



| YATO | Ø (mm) | L (mm) | B (mm) | D (mm) | S1 (mm) | S2 (mm) | PCS packing | |
|---------|--------|--------|--------|--------|---------|---------|-------------|-----|
| YT-0207 | 6x7 | 168 | 10.4 | 11.9 | 5.7 | 6.2 | 10 | 320 |
| YT-0209 | 8x9 | 183 | 13.3 | 14.8 | 6.7 | 7.2 | 10 | 160 |
| YT-0211 | 10x11 | 198 | 16.3 | 17.7 | 7.7 | 8.8 | 10 | 100 |
| YT-0213 | 12x13 | 217 | 19.2 | 20.6 | 8.7 | 9.2 | 10 | 100 |
| YT-0215 | 14x15 | 239 | 22.1 | 23.4 | 9.6 | 10.1 | 5 | 50 |
| YT-0217 | 16x17 | 260 | 25.0 | 26.4 | 10.6 | 10.9 | 5 | 60 |

| YATO | Ø (mm) | L (mm) | B (mm) | D (mm) | S1 (mm) | S2 (mm) | PCS packing | |
|---------|--------|--------|--------|--------|---------|---------|-------------|----|
| YT-0219 | 18x19 | 292 | 27.9 | 29.4 | 11.2 | 11.5 | 5 | 60 |
| YT-0222 | 20x22 | 318 | 30.8 | 33.7 | 11.8 | 12.5 | 5 | 30 |
| YT-0223 | 21x23 | 326 | 32.3 | 35.2 | 12.1 | 12.8 | 5 | 30 |
| YT-0227 | 24x27 | 329 | 36.6 | 40.7 | 13.1 | 14.0 | 5 | 30 |
| YT-0228 | 25x28 | 347 | 38.1 | 42.5 | 14.0 | 14.3 | 2 | 16 |
| YT-0232 | 30x32 | 362 | 45.2 | 49.2 | 15.0 | 15.7 | 2 | 16 |

1

- GB Bi-hexagonal ring spanner set
- D Doppelringschlüsselsatz
- PL Komplet kluczy oczkowych odgiętych
- RUS Набор ключей накидных изогнутых
- CZ Klíče očkové vyhnuté sada
- H Csillagkulcs készlet
- RO Set chei inelare cu cot
- E Juego de llaves de estrella acodadas
- CN 双头高颈梅花扳手组套

POUCH
& COLOR
BOX



DIN 838 CrV 6140 AS-DRIVE



8 PCS 6x7, 8x9, 10x11, 12x13, 14x15, 16x17, 18x19, 20x22 mm

10 PCS 6x7, 8x9, 10x11, 12x13, 14x15, 16x17, 18x19, 20x22, 21x23, 24x27 mm

12 PCS 6x7, 8x9, 10x11, 12x13, 14x15, 16x17, 18x19, 20x22, 21x23, 24x27, 25x28, 30x32 mm

| | |
|-------------|---|
| YATO | |
| YT-0248 | 6 |

| | |
|-------------|----|
| YATO | |
| YT-0250 | 10 |

| | |
|-------------|---|
| YATO | |
| YT-0252 | 4 |

- GB Bi-hexagonal ring spanner
- D Doppelringschlüssel
- PL Klucz oczkowy odgięty
- RUS Ключ накидной изогнутый
- CZ Očkový klíč ohnutý
- H Hajlítottszárú csillagkulcs
- RO Cheie inelaro-curbată
- E Llave de estrella
- CN 双头高颈梅花扳手

S.A.E. DIN 838 CrV AS-DRIVE

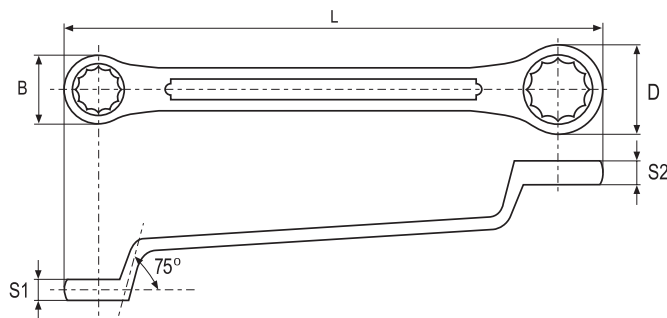

- application: industry
- surface finish: chromed, satin / mirror
- przeznaczenie: przemysł
- wykończenie powierzchni: chromowana, satynowa / polerowana





| YATO | | L (mm) | B (mm) | D (mm) | S1 (mm) | S2 (mm) | PCS packing: | |
|-------------|-----------------------------------|--------|--------|--------|---------|---------|--------------|---------|
| YT-4860 | 3/8" (9.5 mm) x 7/16" (11.1 mm) | 200 | 16.2 | 17.5 | 6.8 | 6.4 | 10 | 150/300 |
| YT-4861 | 1/2" (12.7 mm) x 9/16" (14.3 mm) | 235 | 21.8 | 23.3 | 8.4 | 8.3 | 10 | 80/160 |
| YT-4862 | 11/16" (17.5 mm) x 3/4" (19.0 mm) | 265 | 27.0 | 28.3 | 10.1 | 10.0 | 10 | 50/100 |

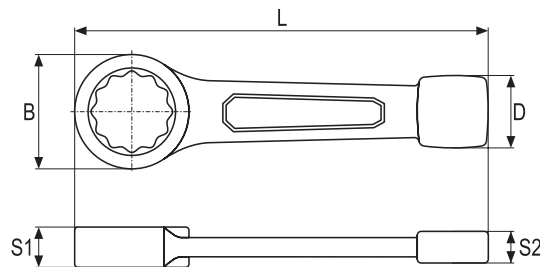

| YATO | | L (mm) | B (mm) | D (mm) | S1 (mm) | S2 (mm) | PCS packing: | |
|-------------|-----------------------------------|--------|--------|--------|---------|---------|--------------|-------|
| YT-4863 | 13/16" (20.6 mm) x 7/8" (22.2 mm) | 280 | 30.5 | 33.3 | 11.1 | 11.9 | 10 | 20/40 |
| YT-4864 | 7/8" (22.2 mm) x 15/16" (23.8 mm) | 305 | 33.2 | 35.9 | 11.8 | 13.3 | 5 | 10 |
| YT-4865 | 15/16" (23.8 mm) x 1" (25.4 mm) | 325 | 35.8 | 40.0 | 13.6 | 13.7 | 5 | 10 |

GB Ring impact wrench
D Schlagringschlüssel
PL Klucz do pobijania oczkowy
RUS Ключ закрытый для растряски
CZ Klíč maticový očkový rázový
H Űtőcsillagkulcs
RO Cheie inelară cu bătător
E Llave de muletilla para usarse dando golpes
CN 敲击梅花扳手



- application: industry
- 12 point profile
- AS-Drive system
- drop forged
- surface finish: black oxidised
- przeznaczenie: przemysł
- profil 12-kątny
- system AS-Drive
- kute
- wykończenie powierzchni: czarna, oksydowana



| YATO  | Ø (mm) | L (mm) | B (mm) | D (mm) | S1 (mm) | S2 (mm) |  |
|--|--------|--------|--------|--------|---------|---------|---|
| YT-1601 | 24 | 160 | 41 | 31 | 15.0 | 10 | 5/25 |
| YT-1602 | 27 | 185 | 47 | 33 | 15.0 | 12 | 5/25 |
| YT-1603 | 30 | 190 | 51 | 35 | 16.5 | 14 | 5/25 |
| YT-1604 | 32 | 195 | 54 | 37 | 16.5 | 15 | 5/25 |
| YT-1605 | 36 | 210 | 60 | 39 | 20.0 | 17 | 5/10 |
| YT-1606 | 38 | 210 | 60 | 39 | 20.0 | 17 | 5/10 |
| YT-1607 | 41 | 225 | 66 | 42 | 20.0 | 18 | 5/10 |

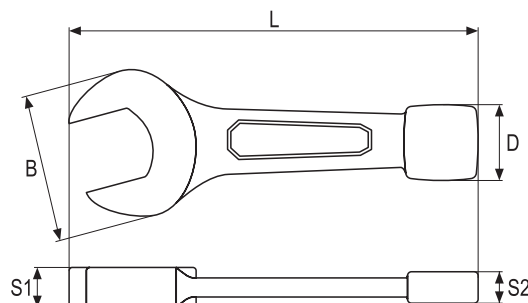

| YATO  | Ø (mm) | L (mm) | B (mm) | D (mm) | S1 (mm) | S2 (mm) |  |
|--|--------|--------|--------|--------|---------|---------|---|
| YT-1608 | 46 | 240 | 74 | 44 | 22.0 | 19 | 5/10 |
| YT-1609 | 50 | 250 | 80 | 45 | 23.0 | 20 | 5/10 |
| YT-1610 | 55 | 270 | 86 | 55 | 25.0 | 22 | 5/10 |
| YT-1611 | 58 | 270 | 86 | 55 | 25.0 | 22 | 5 |
| YT-1612 | 60 | 270 | 92 | 60 | 25.0 | 23 | 5 |
| YT-1613 | 65 | 290 | 100 | 65 | 30.0 | 24 | 5 |
| YT-1614 | 70 | 310 | 108 | 70 | 32.0 | 25 | 5 |

GB Open end impact wrench
D Schlagschraubenschlüssel
PL Klucz do pobijania płaski
RUS Ключ плоский для растряски
CZ Klíč maticový plochý rázový
H Űtőlaposkulcs
RO Cheie fixă cu bătător
E Llave de boca abierta para usarse dando golpes
CN 敲击开口扳手



- application: industry
- head offset: 15°
- drop forged
- surface finish: black oxidised
- przeznaczenie: przemysł
- kąt odchylenia główki: 15°
- kute
- wykończenie powierzchni: czarna, oksydowana

| YATO  | Ø (mm) | L (mm) | B (mm) | D (mm) | S1 (mm) | S2 (mm) |  |
|--|--------|--------|--------|--------|---------|---------|---|
| YT-1615 | 27 | 180 | 55 | 33 | 15 | 12 | 5/25 |
| YT-1616 | 30 | 187 | 63 | 35 | 17 | 14 | 5/25 |
| YT-1617 | 32 | 195 | 67 | 37 | 18 | 15 | 5/25 |
| YT-1618 | 36 | 210 | 77 | 39 | 18 | 17 | 5/10 |

| YATO  | Ø (mm) | L (mm) | B (mm) | D (mm) | S1 (mm) | S2 (mm) |  |
|--|--------|--------|--------|--------|---------|---------|---|
| YT-1619 | 41 | 225 | 89 | 42 | 20 | 18 | 5/10 |
| YT-1620 | 46 | 255 | 98 | 44 | 20 | 19 | 5/10 |
| YT-1621 | 50 | 280 | 107 | 45 | 22 | 20 | 5 |
| YT-1622 | 55 | 310 | 118 | 55 | 25 | 22 | 5 |

1

GB Half-moon spanner
 D Starter- und Blockschlüssel
 PL Klucz oczkowy typu „C”
 RUS Ключ накладной изогнутый „С”
 CZ Klič očkoplochý typ „C”
 H Félhold alakú csillagkulcs
 RO Cheie inelara semi-luna
 E Llave de estrella tipo „C”
 CN C型梅花扳手

- application: industry
- excellent for work in tight spaces
- used for dismantling of collector tubes, alternators and starters
- surface finish: chromed, satin
- przeznaczenie: przemysł
- do pracy w miejscach szczególnie trudnodostępnych
- ułatwia odkręcanie kolektorów, alternatorów i rozruszników samochodowych
- wykończenie powierzchni: chromowana, satynowa

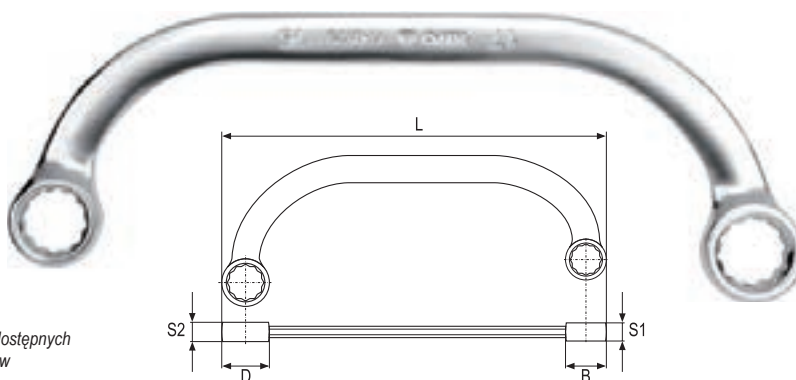

CrV 6140 AS-DRIVE

| YATO | Ø (mm) | L (mm) | B (mm) | D (mm) | S1 (mm) | S2 (mm) | Box |
|---------|--------|--------|--------|--------|---------|---------|-------|
| YT-0170 | 10x12 | 145 | 16.8 | 19.2 | 6.8 | 6.8 | 10/60 |
| YT-0171 | 11x13 | 170 | 18.5 | 21.2 | 8.4 | 8.6 | 10/60 |
| YT-0172 | 14x15 | 195 | 22.8 | 25.8 | 9.2 | 9.9 | 10/60 |

| YATO | Ø (mm) | L (mm) | B (mm) | D (mm) | S1 (mm) | S2 (mm) | Box |
|---------|--------|--------|--------|--------|---------|---------|-------|
| YT-0173 | 16x17 | 220 | 26.2 | 28.6 | 9.9 | 10.5 | 10/60 |
| YT-0175 | 19x22 | 260 | 28.7 | 32.9 | 10.4 | 10.9 | 6/60 |

GB Reversible half-moon spanner
 D Doppelringratschenschlüssel
 PL Klucz typu „C” z grzechotką
 RUS Ключ накладной изогнутый с трещоткой
 CZ Klič očkový ráčnový typu „C”
 H Csillagkulcs racsnis hajlított
 RO Cheie reversibila semi-luna
 E Llave de carraca de dos bocas con angulo
 CN C型双向棘轮梅花扳手

- application: industry
- minimum operation angle: 5°
- direction switch
- excellent for work in tight spaces
- used for dismantling of collector tubes, alternators and starters
- surface finish: chromed, mirror
- przeznaczenie: przemysł
- minimalny kąt pracy: 5°
- zmiana kierunku obrotu
- do pracy w miejscach szczególnie trudnodostępnych
- ułatwia odkręcanie kolektorów, alternatorów i rozruszników samochodowych
- wykończenie powierzchni: chromowana, polerowana

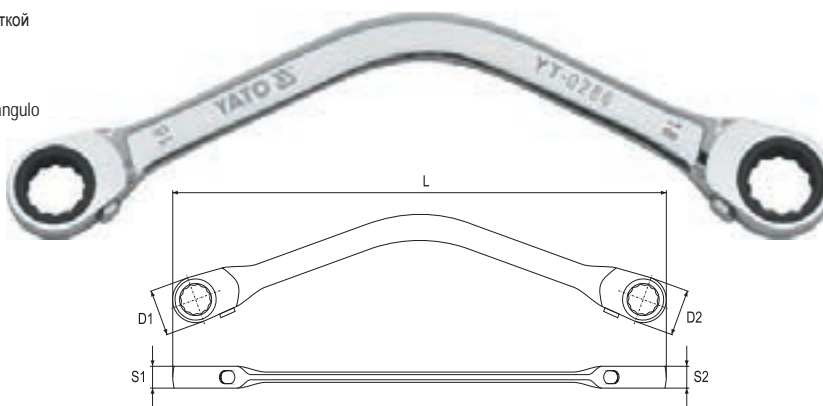

72T CrV 6140 AS-DRIVE

| YATO | Ø (mm) | L (mm) | D1 (mm) | D2 (mm) | S1 (mm) | S2 (mm) | Box |
|---------|--------|--------|---------|---------|---------|---------|--------|
| YT-0283 | 10x11 | 192 | 21.0 | 21.9 | 8.4 | 8.4 | 10/100 |
| YT-0284 | 12x15 | 206 | 23.6 | 28.2 | 8.4 | 8.4 | 10/100 |

| YATO | Ø (mm) | L (mm) | D1 (mm) | D2 (mm) | S1 (mm) | S2 (mm) | Box |
|---------|--------|--------|---------|---------|---------|---------|--------|
| YT-0286 | 16x18 | 247 | 28.6 | 31.7 | 10.0 | 11.5 | 10/100 |
| YT-0287 | 17x19 | 260 | 29.7 | 33.8 | 10.0 | 11.5 | 10/100 |

PLASTIC HANGER



GB Flare nut wrench
 D Schraubenschlüssel, halboffen
 PL Klucz oczkowy półotwarty
 RUS Ключ накладной полуоткрытый
 CZ Klič prstencový polootevřený

H Csuklós, nyitott
 RO Cheie inelară semideschisă
 E Llave semiabierta
 CN 油管扳手

CrV 6140

GB Flare nut wrench set
 D Schraubenschlüssel, halboffen
 PL Zestaw kluczy oczkowych półotwartych
 RUS Ключ накладной полуоткрытый
 CZ Klič prstencový polootevřený

H Csuklós, nyitott
 RO Cheie inelară semideschisă
 E Llave semiabierta
 CN 油管扳手组套

4 PCS



CrV 6140

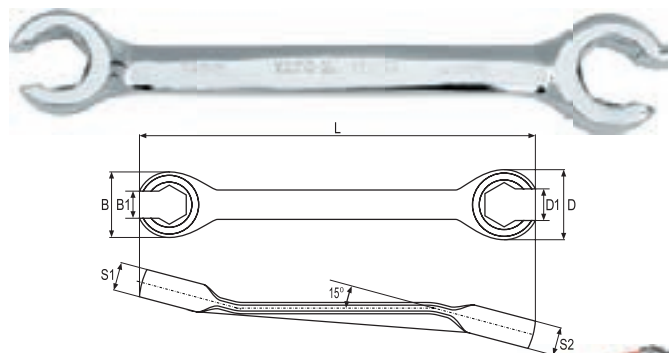

COLOR BOX

| YATO | Ø (mm) | L (mm) | B (mm) | D (mm) | B1 (mm) | D1 (mm) | S1 (mm) | S2 (mm) | PCS packing: | Box |
|---------|--------|--------|--------|--------|---------|---------|---------|---------|--------------|---------|
| YT-0135 | 8x10 | 140 | 18.7 | 21.8 | 6.2 | 7.2 | 7.7 | 8.4 | 10 | 200/400 |
| YT-0136 | 11x12 | 160 | 21.2 | 24.0 | 8.1 | 9.2 | 8.5 | 9.5 | 10 | 100/200 |
| YT-0137 | 13x14 | 175 | 26.3 | 27.3 | 9.6 | 10.7 | 9.6 | 10.5 | 10 | 100/200 |
| YT-0138 | 15x17 | 190 | 31.2 | 31.2 | 11.8 | 13.0 | 11.5 | 10.9 | 10 | 50/100 |
| YT-0139 | 19x21 | 230 | 36.3 | 42.1 | 14.7 | 16.7 | 12.4 | 12.8 | 10 | 50/100 |
| YT-0140 | 22x24 | 250 | 42.7 | 44.2 | 17.1 | 18.6 | 13.2 | 13.9 | 10 | 50/100 |



8x10, 11x12, 13x14, 15x17 mm

POUCH & COLOR BOX



| YATO | Box |
|---------|-------|
| YT-0143 | 25/50 |

GB Flexible flare nut wrench
D Schraubenschlüssel, halboffen mit Gelenk
PL Klucz oczkowy półotwarty z przegubem
RUS Ключ накладной полуоткрытый с шарниром
CZ Klíč prstencový polootevřený s kloubem
H Csuklós, nyitott csillagkulcs
RO Cheie inelară semideschisă, cu articulație
E Llave semiabierta con una junta
CN 活头油管扳手

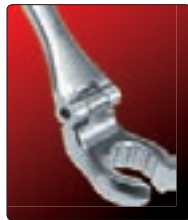

GB Flexible flare nut wrench set
D Schraubenschlüssel, halboffen mit Gelenk
PL Komplet kluczy oczkowych półotwartych z przegubem
RUS Ключ накладной полуоткрытый с шарниром
CZ Klíč prstencový polootevřený s kloubem
H Csuklós, nyitott csillagkulcs
RO Cheie inelară semideschisă, cu articulație
E Llave semiabierta con una junta
CN 活头油管扳手组套

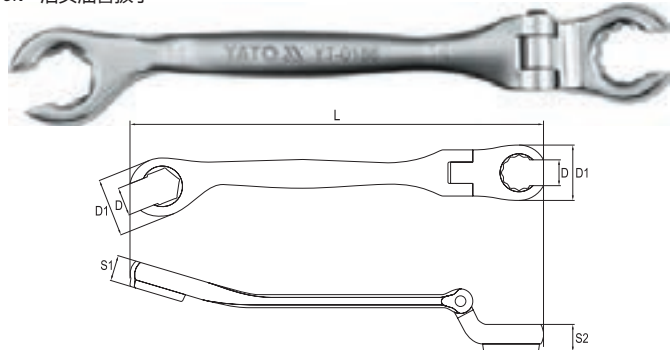
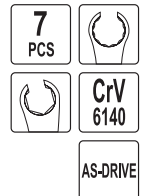
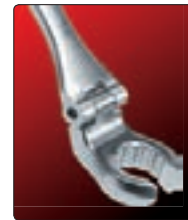

- application: industry
- articulated joint at 12 point head
- ring for nuts in sockets
- for use on hydraulic lines
- for use on fuel lines
- for use on brake system lines
- ergonomic handle
- surface finish: chromed, satin
- przeznaczenie: przemysł
- przegub przy profilu 12-kątnym
- pierścień do gniazd nakrętek
- do przewodów hydraulicznych
- do przewodów paliwowych
- do przewodów hamulcowych
- ergonomiczna rączka
- wykończenie powierzchni: chromowana, satynowa

PLASTIC HANGER

| YATO | Ø (mm) | L (mm) | D (mm) | D1 (mm) | S1 (mm) | S2 (mm) | |
|---------|--------|--------|--------|---------|---------|---------|--------|
| YT-0180 | 8 | 128 | 6.0 | 18.0 | 7.0 | 7.0 | 24/288 |
| YT-0181 | 9 | 128 | 6.5 | 18.0 | 7.0 | 7.0 | 24/288 |
| YT-0183 | 11 | 146 | 8.5 | 22.0 | 9.0 | 9.0 | 24/216 |
| YT-0184 | 12 | 148 | 9.0 | 22.0 | 9.0 | 9.0 | 24/216 |
| YT-0185 | 13 | 175 | 10.0 | 26.0 | 11.0 | 11.0 | 12/120 |
| YT-0186 | 14 | 175 | 11.0 | 26.0 | 11.0 | 11.0 | 12/120 |
| YT-0187 | 15 | 175 | 12.0 | 26.0 | 11.0 | 11.0 | 12/120 |

GB Torx ring spanner set
D Torx-Ringschlüsselsatz
PL Komplet kluczy oczkowych Torx
RUS Набор накидных ключей
CZ Očkové klíče
H Csillagkulcs készlet
RO Cheie inelare
E Llaves de anillo Torx
CN 星型扳手组套



E6xE8, E10xE12, E14xE18, E20xE24

SLIDING CARD

| YATO | |
|---------|-------|
| YT-0530 | 10/60 |

GB L-type socket wrench
D Steckschlüssel gebogen
PL Klucz nasadowy typu „L”
RUS Ключ торцевой „L” типа
CZ Nástrčný klíč fajfkový
H Kulcs, dugó-pipa
RO Cheie tubulara cu cot tip „L”
E Llave de vaso „L”
CN L 型套筒扳手

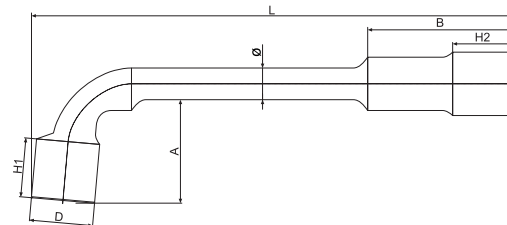

| YATO | Ø (mm) | L (mm) | B (mm) | H1 (mm) | H2 (mm) | A (mm) | D (mm) | Ø (mm) | |
|---------|--------|--------|--------|---------|---------|--------|--------|--------|-------|
| YT-1626 | 6 | 102 | 25.0 | 10.0 | 11.0 | 16.0 | 10.0 | 7 | 12/60 |
| YT-1627 | 7 | 106 | 27.0 | 10.2 | 10.1 | 21.0 | 10.7 | 7 | 12/60 |
| YT-1628 | 8 | 117 | 29.5 | 12.3 | 11.9 | 18.5 | 12.2 | 9 | 12/60 |
| YT-1629 | 9 | 121 | 31.7 | 13.4 | 12.8 | 19.1 | 13.2 | 10 | 12/60 |
| YT-1630 | 10 | 131 | 35.1 | 16.4 | 16.9 | 23.3 | 15.0 | 10 | 12/60 |
| YT-1631 | 11 | 138 | 36.0 | 16.5 | 16.8 | 24.7 | 16.3 | 11 | 12/60 |
| YT-1632 | 12 | 147 | 42.5 | 17.9 | 18.2 | 17.9 | 18.0 | 12 | 12/60 |
| YT-1633 | 13 | 154 | 44.2 | 18.5 | 19.1 | 30.1 | 19.3 | 12 | 12/60 |
| YT-1634 | 14 | 162 | 47.0 | 19.3 | 20.3 | 30.2 | 20.8 | 13 | 12/60 |
| YT-1635 | 15 | 173 | 48.9 | 20.6 | 21.6 | 31.6 | 22.3 | 13 | 12/60 |
| YT-1636 | 16 | 182 | 55.0 | 23.2 | 23.1 | 37.3 | 23.6 | 14 | 12/60 |
| YT-1637 | 17 | 188 | 57.0 | 25.1 | 25.5 | 37.9 | 25.1 | 14 | 12/36 |

| YATO | Ø (mm) | L (mm) | B (mm) | H1 (mm) | H2 (mm) | A (mm) | D (mm) | Ø (mm) | |
|---------|--------|--------|--------|---------|---------|--------|--------|--------|-------|
| YT-1638 | 18 | 192 | 57.1 | 25.1 | 24.6 | 40.1 | 26.0 | 14 | 12/36 |
| YT-1639 | 19 | 207 | 62.3 | 26.9 | 27.4 | 41.6 | 28.2 | 16 | 12/36 |
| YT-1640 | 20 | 215 | 62.4 | 27.0 | 28.3 | 42.4 | 29.2 | 16 | 6/24 |
| YT-1641 | 21 | 221 | 65.0 | 30.5 | 30.6 | 54.0 | 30.2 | 16 | 6/24 |
| YT-1642 | 22 | 232 | 67.5 | 30.8 | 30.6 | 49.1 | 31.7 | 16 | 6/24 |
| YT-1643 | 23 | 242 | 77.1 | 31.4 | 31.2 | 51.6 | 33.0 | 17 | 6/18 |
| YT-1644 | 24 | 253 | 78.2 | 32.3 | 31.7 | 53.5 | 33.6 | 17 | 6/18 |
| YT-1647 | 27 | 288 | 85.3 | 36.9 | 36.4 | 54.7 | 37.6 | 20 | 6/12 |
| YT-1648 | 28 | 295 | 87.6 | 37.8 | 37.8 | 60.6 | 39.2 | 20 | 6/12 |
| YT-1649 | 30 | 310 | 95.0 | 38.4 | 38.6 | 65.3 | 42.0 | 22 | 6/12 |
| YT-1650 | 32 | 339 | 99.2 | 40.4 | 40.5 | 66.8 | 43.8 | 22 | 6 |

1

GB Open end swivel head socket wrench
 D Maul-Steckschlüssel
 PL Klucz płasko-nasadowy przegubowy
 RUS Ключ рожково-торцевой
 CZ Klic nasad. ploch.

H Kulcs villás-dugó
 RO Cheie fixe-tubulare
 E Combinada con vaso
 CN 套筒开口扳手

CrV
6140

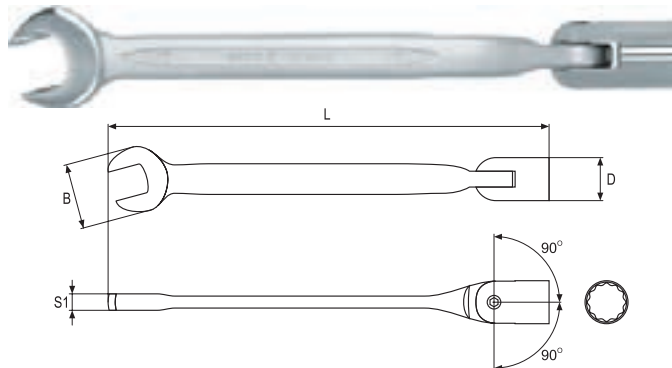

COLOR BOX

| YATO | Ø (mm) | L (mm) | B (mm) | D (mm) | S1 (mm) | PCS packing: | |
|---------|--------|--------|--------|--------|---------|--------------|-----|
| YT-4950 | 8 | 168 | 19.5 | 12.9 | 6.0 | 10 | 240 |
| YT-4951 | 10 | 178 | 20.7 | 14.6 | 6.4 | 10 | 240 |
| YT-4952 | 11 | 188 | 25.4 | 15.9 | 6.9 | 10 | 200 |
| YT-4953 | 12 | 191 | 25.3 | 17.9 | 6.7 | 10 | 160 |
| YT-4954 | 13 | 205 | 28.8 | 18.8 | 6.8 | 10 | 120 |
| YT-4955 | 14 | 222 | 31.8 | 19.8 | 6.8 | 10 | 80 |
| YT-4956 | 17 | 232 | 37.0 | 23.9 | 7.8 | 10 | 80 |
| YT-4957 | 19 | 248 | 42.1 | 25.8 | 7.5 | 10 | 60 |

GB Double flexible socket wrench
 D Steckschlüssel
 PL Klucz nasadowy przegubowy
 RUS Ключ торцевой
 CZ Nástrčné kľíče kloubové

H Csuklós dugókulcs
 RO Set chei tubulare cu articulație
 E Llave de vaso articulado
 CN 活头双头套筒扳手

CrV
6140

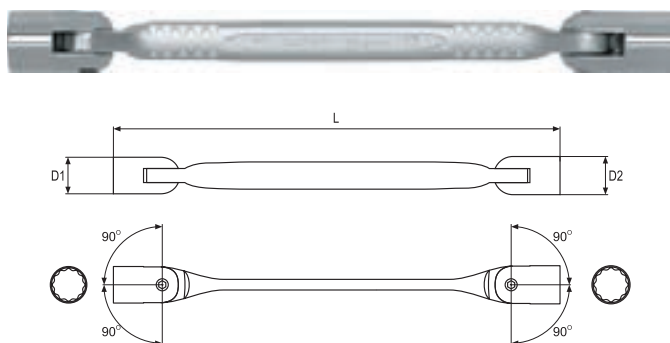

COLOR BOX

| YATO | Ø (mm) | L (mm) | D1 (mm) | D2 (mm) | PCS packing: | |
|---------|--------|--------|---------|---------|--------------|-----|
| YT-4961 | 8x9 | 183 | 12.9 | 13.7 | 10 | 200 |
| YT-4962 | 10x11 | 202 | 14.6 | 15.8 | 10 | 160 |
| YT-4963 | 12x13 | 218 | 17.6 | 18.8 | 10 | 120 |
| YT-4964 | 14x15 | 239 | 19.8 | 21.7 | 10 | 80 |
| YT-4965 | 16x17 | 257 | 23.8 | 23.9 | 10 | 40 |
| YT-4966 | 18x19 | 274 | 25.8 | 25.8 | 10 | 40 |

GB Open end swivel head socket wrench set
 D Maul-Steckschlüsselsatz
 PL Klucze płasko-nasadowe przegubowe
 RUS Ключи рожк.-торц.-наѡр
 CZ Ploché nřstrčné kľíče kloubové
 H Kulcs villás-csuklós dugó
 RO Set chei fixe + tubulare
 E Combinadas con vaso articulado
 CN 套筒开口扳手组套

6
PCS

CrV
6140



POUCH & COLOR BOX

8, 10, 12, 13, 17, 19 mm

YATO

YT-4960

20

GB Double ended swivel socket wrench set
 D Doppelgelenkschlüsselsatz
 PL Klucze nasadowo-przegubowe
 RUS Ключи рожк.-торц.-наѡр
 CZ Nástrčné kľíče kloubové
 H Csuklós dugókulcs
 RO Set chei tubulare cu articulație
 E Llave de vaso articulado
 CN 活头双头套筒扳手组套

6
PCS

CrV
6140



POUCH & COLOR BOX

8x9, 10x11, 12x13, 14x15, 16x17, 18x19 mm

YATO

YT-4967

12

- GB Heavy duty tubular socket wrench
D Rohrsteckschlüsselsatz
PL Klucz rurowy kuty
RUS Ключ двухлучевой с головками
CZ Klíče trubkové
H Csőkulcs
RO Cheie pt. țevi
E Llave de tubería
CN 小轮胎扳手

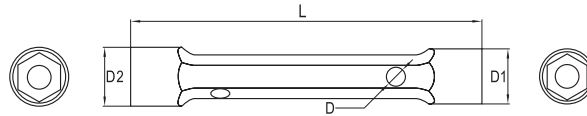

CrV
40 AS-DRIVE

COLOR BOX



| YATO | Ø (mm) | D1 (mm) | D2 (mm) | D (mm) | L (mm) | PCS packing: | |
|---------|--------|---------|---------|--------|--------|--------------|--------|
| YT-4915 | 8x9 | 13 | 14 | 3 | 110 | 10 | 60/240 |
| YT-4916 | 10x11 | 15 | 16 | 5 | 120 | 10 | 60/240 |
| YT-4917 | 12x13 | 18 | 19 | 6 | 140 | 10 | 60/120 |
| YT-4918 | 14x15 | 20 | 22 | 6 | 145 | 10 | 60/120 |
| YT-4919 | 16x17 | 23 | 24 | 7 | 155 | 10 | 60/120 |
| YT-4920 | 18x19 | 25 | 26 | 8 | 165 | 5 | 40/80 |

| YATO | Ø (mm) | D1 (mm) | D2 (mm) | D (mm) | L (mm) | PCS packing: | |
|---------|--------|---------|---------|--------|--------|--------------|-------|
| YT-4921 | 20x22 | 28 | 30 | 8 | 170 | 5 | 30/60 |
| YT-4922 | 21x23 | 29 | 31 | 10 | 185 | 5 | 30/60 |
| YT-4923 | 24x26 | 33 | 35 | 12 | 190 | 5 | 40 |
| YT-4924 | 25x28 | 34 | 37 | 12 | 205 | 5 | 40 |
| YT-4925 | 27x29 | 37 | 39 | 12 | 210 | 5 | 40 |
| YT-4926 | 30x32 | 40 | 42 | 13 | 210 | 5 | 20 |

- GB Tubular socket wrench handle
D Stellstab für Rohrschlüssel
PL Pokręto do kluczy rurowych
RUS Вороток к трубчатым ключам
CZ Tyčka k trubkovým klíčům
H Forgatókar dugókulcshoz
RO Clupă pt. chei tubulare
E Mango para las llaves de tubo
CN 旋棒



COLOR BOX



| YATO | L (mm) | mm | PCS packing: | |
|---------|--------|---------------------------|--------------|-----|
| YT-4927 | 190 | 2.5; 4.5; 5.5 | 50 | 150 |
| YT-4928 | 280 | 6.5; 7.5; 9.5; 11.5; 12.5 | 50 | 100 |

- GB Ratchet wrench
D Gerüstratsche
PL Klucz nasadowy z grzechotką
RUS Ключ торцовый с трещоткой
CZ Ráčnový kľúč prúchozí
H Kettős racsnis kulcs
RO Cheie tubulara cu clichet
E Llave de vaso con carraca
CN 尖尾棘轮扳手

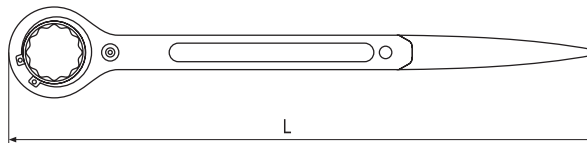

CrV 32T RATCHET WRENCH COLD FORGED KUTE NA ZIMNO



PLASTIC HANGER

| YATO | Ø (mm) | L (mm) | |
|---------|--------|--------|------|
| YT-4937 | 19x22 | 315 | 2/40 |

- GB Double ratchet wrench
D Gerüstratsche
PL Dwustronny klucz nasadowy z grzechotką
RUS Ключ торцовый с трещоткой
CZ Ráčnový kľúč prúchozí dvoustranný
H Kettős racsnis kulcs
RO Cheie tubulara dubla cu clichet
E Llave de vaso con carraca
CN 尖尾棘轮扳手

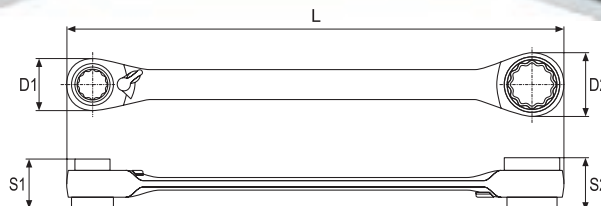

CrV 72T RATCHET WRENCH

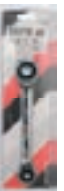

DOUBLE BLISTER

| YATO | Ø (mm) | L (mm) | D1 (mm) | D2 (mm) | S1 (mm) | S2 (mm) | |
|---------|-------------|--------|---------|---------|---------|---------|------|
| YT-4945 | 10x13x17x19 | 200 | 29 | 35 | 17 | 22 | 5/50 |

- GB Socket wrench with handle
D Steckschlüssel
PL Klucz nasadowy z rączką
RUS Ключ торцевой
CZ Nástrčný kľúč
H Kulcs
RO Cheie tubulara
E Llave
CN 六角套筒螺丝批

COLOR BOX



CrV HRC 44

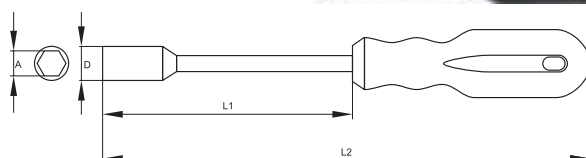

| YATO | Ø (mm) | D (mm) | L1 (mm) | L2 (mm) | PCS packing: | |
|---------|--------|--------|---------|---------|--------------|-----|
| YT-1541 | 5 | 8.0 | 125 | 242 | 6 | 120 |
| YT-1542 | 6 | 9.1 | 125 | 242 | 6 | 120 |
| YT-1543 | 7 | 10.9 | 125 | 242 | 6 | 120 |
| YT-1544 | 8 | 12.0 | 125 | 242 | 6 | 120 |
| YT-1545 | 9 | 13.0 | 125 | 242 | 6 | 120 |
| YT-1546 | 10 | 14.1 | 125 | 242 | 6 | 120 |
| YT-1547 | 11 | 15.9 | 125 | 242 | 6 | 120 |
| YT-1548 | 12 | 16.9 | 125 | 242 | 6 | 120 |
| YT-1549 | 13 | 18.0 | 125 | 242 | 6 | 120 |

1

GB T-type deep socket wrench with rotary handle
D Steckschlüssel vom Typ „T“ mit drehbarem Handgriff
PL Klucz nasadowy typu „T“ z obrotową rękojeścią
RUS Торцовый ключ типа „Т“ с вращательной ручкой
CZ Klič nástrčný typ „T“

H „T“ típusú dugókulcs, forgatható karral
RO Cheie tubulară de tip „T” cu mâner rotativ
E Llave tubular „T” con un mango giratorio
CN T型套筒扳手



COLOR CARDBOARD

CrV 6140
AS-DRIVE

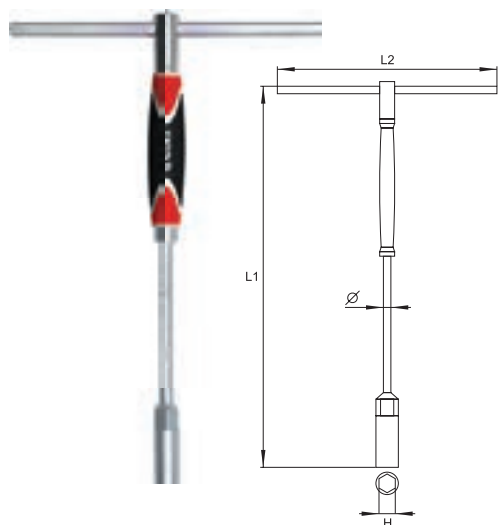

- ergonomic handle
- movable handle with position locking system
- long bar for work in deeply set, difficult to reach places

- ergonomiczna rękojeść
- przesuwane pokrętko z blokadą położenia
- długi trzpień umożliwiający pracę w głębokich wnękach

| YATO | Ø H | L1 (mm) | L2 (mm) | Ø (mm) | |
|---------|-------|---------|---------|--------|-------|
| YT-1552 | 8 mm | 310 | 200 | 10 | 10/40 |
| YT-1553 | 9 mm | 310 | 200 | 10 | 10/40 |
| YT-1554 | 10 mm | 310 | 200 | 10 | 10/40 |
| YT-1555 | 11 mm | 310 | 200 | 10 | 10/40 |
| YT-1556 | 12 mm | 310 | 200 | 10 | 10/40 |
| YT-1557 | 13 mm | 310 | 200 | 10 | 10/40 |
| YT-1558 | 14 mm | 310 | 200 | 10 | 10/40 |
| YT-1559 | 15 mm | 310 | 200 | 10 | 10/40 |

GB T-type deep socket wrench
D Steckschlüssel vom Typ „T“
PL Klucz nasadowy typu „T“
RUS Торцовый ключ типа „Т“
CZ Klič nástrčný typ „T“

H „T” típusú dugókulcs
RO Cheie tubulară de tip „T”
E Llave tubular „T”
CN T型套筒扳手

CrV 6140 AS-DRIVE

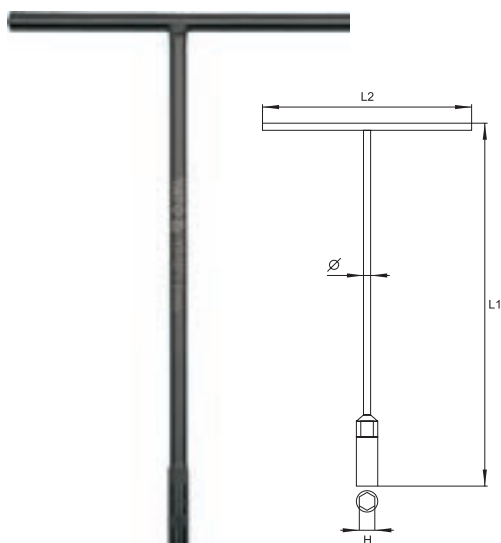

COLOR CARDBOARD



| YATO | Ø H | L1 (mm) | L2 (mm) | Ø (mm) | |
|---------|-------|---------|---------|--------|-------|
| YT-1571 | 8 mm | 310 | 200 | 10 | 10/40 |
| YT-1572 | 9 mm | 310 | 200 | 10 | 10/40 |
| YT-1573 | 10 mm | 310 | 200 | 10 | 10/40 |
| YT-1574 | 11 mm | 310 | 200 | 10 | 10/40 |
| YT-1575 | 12 mm | 310 | 200 | 10 | 10/40 |
| YT-1576 | 13 mm | 310 | 200 | 10 | 10/40 |
| YT-1577 | 14 mm | 310 | 200 | 10 | 10/40 |
| YT-1578 | 15 mm | 310 | 200 | 10 | 10/40 |

GB T-type adapter with rotary handle
D Adapter vom Typ „T” mit drehbarem Handgriff
PL Adapter typu „T” z obrotową rękojeścią
RUS Адаптер типа „Т” с вращательной ручкой
CZ Adaptér typ „T” s otočnou rukojetí
H „T” típusú adapter, forgatható karral
RO Adaptor tip „T” cu mâner rotativ
E Adaptador „T” con un mango giratorio
CN T型套筒扳手



COLOR CARDBOARD

1/4" 6.3mm
3/8" 10mm
1/2" 12.5mm
CrV 6140

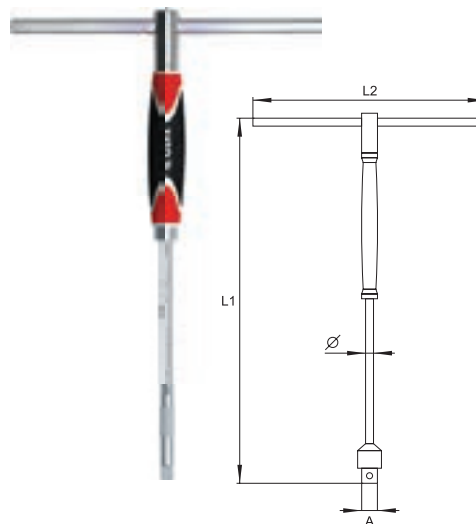

- ergonomic handle
- movable handle with position locking system
- long bar for work in deeply set, difficult to reach places

- ergonomiczna rękojeść
- przesuwane pokrętko z blokadą położenia
- długi trzpień umożliwiający pracę w głębokich wnękach

| YATO | Ø H | L1 (mm) | L2 (mm) | Ø (mm) | |
|---------|----------------|---------|---------|--------|-------|
| YT-1565 | 1/4" (6.3 mm) | 310 | 200 | 8 | 10/40 |
| YT-1566 | 3/8" (9.5 mm) | 310 | 200 | 10 | 10/40 |
| YT-1567 | 1/2" (12.7 mm) | 310 | 200 | 10 | 10/40 |

GB Y-type socket wrench
D Steckschlüssel vom Typ „Y”
PL Klucz nasadowy typu „Y”
RUS Торцовый ключ типа „Y”
CZ Klič nástrčný typ „Y”

H „Y” típusú dugókulcs
RO Cheie tubulară de tip „Y”
E Llave tubular „Y”
CN Y型套筒扳手

CrV 6140 AS-DRIVE



COLOR CARDBOARD



| YATO | Ø H | L (mm) | Ø (mm) | |
|---------|-------------|--------|--------|-------|
| YT-1584 | 8-10-12 mm | 140 | 10 | 10/40 |
| YT-1586 | 12-14-17 mm | 140 | 10 | 10/40 |

GB Adjustable wrench
D Rollgabelschlüssel
PL Klucz nastawny
RUS Ключ разводной



CZ Nastavitelný klíč
H Állítható svédkulcs
RO Cheie reglabilă

E Llave ajustable
tipo inglesa
CN 活络扳手

150 mm 200 mm 250 mm 300 mm 375 mm



HALF
DOUBLE
BLISTER

| YATO  | L (mm) |  |
|--|--------|---|
| YT-2071 | 150 | 6/60 |
| YT-2072 | 200 | 6/60 |
| YT-2073 | 250 | 6/36 |
| YT-2074 | 300 | 6/24 |
| YT-2075 | 375 | 6/12 |

GB Adjustable wrench
D Rollgabelschlüssel
PL Klucz nastawny
RUS Ключ разводной



CZ Nastavitelný klíč
H Állítható svédkulcs
RO Cheie reglabilă

E Llave ajustable
tipo inglesa
CN 活络扳手

150 mm 200 mm 250 mm 300 mm DIN 3117 CrV



HALF
DOUBLE
BLISTER

| YATO  | L (mm) |  |
|---|--------|--|
| YT-2165 | 150 | 6/120 |
| YT-2166 | 200 | 6/60 |
| YT-2167 | 250 | 6/36 |
| YT-2168 | 300 | 6/24 |

GB Adjustable wrench
D Rollgabelschlüssel
PL Klucz nastawny
RUS Ключ разводной



CZ Nastavitelný klíč
H Állítható svédkulcs
RO Cheie reglabilă

E Llave ajustable
tipo inglesa
CN 活络扳手

150 mm 200 mm 250 mm 300 mm DIN 3117 CrV



HALF
DOUBLE
BLISTER

| YATO  | L (mm) |  |
|--|--------|---|
| YT-2170 | 150 | 6/72 |
| YT-2171 | 200 | 6/60 |
| YT-2172 | 250 | 6/48 |
| YT-2173 | 300 | 6/36 |

GB Adjustable wrench
D Rollgabelschlüssel
PL Klucz nastawny
RUS Ключ разводной



CZ Nastavitelný klíč
H Állítható svédkulcs
RO Cheie reglabilă

E Llave ajustable
tipo inglesa
CN 活络扳手

150 mm 200 mm 250 mm 300 mm 375 mm DIN 3117 DROP FORGED KUTE



HALF
DOUBLE
BLISTER

| YATO  | L (mm) | opening capacity (mm) zakres rozwarcia szczęk (mm) |  |
|--|--------|---|---|
| YT-21650 | 150 | 19.3 | 6/36 |
| YT-21651 | 200 | 24.0 | 6/36 |
| YT-21652 | 250 | 30.0 | 6/36 |
| YT-21653 | 300 | 36.0 | 6/24 |
| YT-21654 | 375 | 45.0 | 2/16 |

2

Sockets, accessories & sets
Klucze nasadowe,
akcesoria i zestawy



| | |
|---|---|
| Sockets 1/4" Klucze nasadowe 1/4" |  |
| | 27 |

| | |
|---|----|
| Hexagonal sockets Klucze nasadowe sześciokątne, krótkie | 27 |
| Hexagonal deep sockets Klucze nasadowe sześciokątne, długie | 27 |

| | |
|---|----|
| Bit adapters Adaptory do bitów | 32 |
| Universal joints Przeguby Cardana | 32 |
| Sliding T-bars Pokrętła typu „T” | 32 |
| Flexible handles Pokrętła łamane | 32 |
| Spark plug sockets Klucze nasadowe do świec | 32 |

| | |
|---|---|
| Accessories 1/4" Akcesoria 1/4" |  |
| | 27-28 |

| | |
|--|---|
| Ratchet handles 3/8" Grzechotki 3/8" |  |
| | 33-34 |

| | |
|--|----|
| Extension bars Przedłużki | 27 |
| Extension bars with wobble Przedłużki uchyłne | 27 |
| Flexible extension cords Przedłużki elastyczne | 28 |
| Adapters Redukcje | 28 |
| Bit adapters Adaptory do bitów | 28 |
| Universal joints Przeguby Cardana | 28 |
| Spinner handles Pokrętła do nasadek | 28 |
| Sliding T-bars Pokrętła typu „T” | 28 |
| Flexible handles Pokrętła łamane | 28 |

| | |
|---|----|
| Ratchet handles Grzechotki | 33 |
| Flexible ratchet handles Grzechotki z przegubem | 33 |
| Composite ratchet handles Grzechotki powlekane | 33 |
| Curved ratchet handles Grzechotki wygięte | 33 |
| Telescopic ratchet handles Grzechotki z przedłużonym uchwytem | 34 |
| Ratchet handles with traction belt Grzechotki z paskiem transmisyjnym | 34 |

| | |
|--|---|
| Ratchet handles 1/4" Grzechotki 1/4" |  |
| | 29-30 |

| | |
|---|---|
| Sockets 1/2" Klucze nasadowe 1/2" |  |
| | 35-36 |

| | |
|--|----|
| Ratchet handles Grzechotki | 29 |
| Flexible ratchet handles Grzechotki z przegubem | 29 |
| Composite ratchet handles Grzechotki powlekane | 29 |
| Curved ratchet handles Grzechotki wygięte | 29 |
| Telescopic ratchet handles Grzechotki z przedłużonym uchwytem | 30 |
| Bit and socket drive ratchet handles Grzechotki do bitów i nasadek | 30 |
| Rotary head ratchet handles Grzechotki z obrotową głowicą | 30 |

| | |
|---|----|
| Hexagonal sockets Klucze nasadowe sześciokątne, krótkie | 35 |
| Bi-hexagonal sockets Klucze nasadowe dwunastokątne, krótkie | 35 |
| Spline sockets Klucze nasadowe „Spline” | 35 |
| Hexagonal deep sockets Klucze nasadowe sześciokątne, długie | 36 |

| | |
|---|---|
| Sockets 3/8" Klucze nasadowe 3/8" |  |
| | 31 |

| | |
|---|----|
| Hexagonal sockets Klucze nasadowe sześciokątne, krótkie | 31 |
| Hexagonal deep sockets Klucze nasadowe sześciokątne, długie | 31 |

| | |
|---|---|
| Accessories 1/2" Akcesoria 1/2" |  |
| | 36-37 |

| | |
|---|----|
| Extension bars Przedłużki | 36 |
| Extension bars with wobble Przedłużki uchyłne | 36 |
| Adapters Redukcje | 37 |
| Bit adapters Adaptory do bitów | 37 |
| Universal joints Przeguby Cardana | 37 |
| Sliding T-bars Pokrętła typu „T” | 37 |
| Flexible handles Pokrętła łamane | 37 |
| L-type handles Pokrętła typu „L” | 37 |
| Spark plug sockets Klucze nasadowe do świec | 37 |









| | |
|---|---|
| Accessories 3/8" Akcesoria 3/8" |  |
| | 31-32 |

| | |
|--|---|
| Ratchet handles 1/2" Grzechotki 1/2" |  |
| | 38-39 |

| | |
|---|----|
| Extension bars Przedłużki | 31 |
| Extension bars with wobble Przedłużki uchyłne | 31 |
| Adapters Redukcje | 32 |

| | |
|--------------------------------------|----|
| Ratchet handles Grzechotki | 38 |
|--------------------------------------|----|



| | | | | |
|---|-------|--|-------|---|
| Flexible ratchet handles Grzechotki z przegubem..... | 38 | Sockets 3/4" Klucze nasadowe 3/4" | 63 |  |
| Composite ratchet handles Grzechotki powlekane..... | 38 | | | |
| Curved ratchet handles Grzechotki wygięte..... | 38 | | | |
| Telescopic ratchet handles Grzechotki z przedłużonym uchwytem..... | 39 | Accessories 3/4" Akcesoria 3/4" | 63-64 |  |
| Rotary head ratchet handles Grzechotki z obrotową głowicą..... | 39 | | | |
| Socket sets Zestawy kluczy nasadowych | | | | |
| | 40-42 | | |  |
| Socket sets 1/2" Zestawy kluczy nasadowych 1/2" | 40 | Extension bars Przedłużki..... | 63 | |
| Socket sets 1/2", 3/8", 1/4" Zestawy kluczy nasadowych 1/2", 3/8", 1/4" | 41 | Adapters Redukcje..... | 63 | |
| | | Universal joints Przeguby Cardana..... | 63 | |
| | | Sliding T-bars Pokręta typu „T”..... | 63 | |
| | | Flexible handles Pokręta łamane..... | 64 | |
| | | L-type handles Pokręta typu „L”..... | 64 | |
| Socket sets Zestawy kluczy nasadowych | | | | |
| | 43-61 | | |  |
| Socket sets 1/4" Zestawy kluczy nasadowych 1/4" | 43 | Ratchet handles 3/4" Grzechotki 3/4" | 64 |  |
| Socket sets 3/8" Zestawy kluczy nasadowych 3/8" | 47 | | | |
| Socket sets 1/2" Zestawy kluczy nasadowych 1/2" | 49 | Socket sets 3/4" Zestawy kluczy nasadowych 3/4" | 64 |  |
| Socket sets 1/2", 1/4" Zestawy kluczy nasadowych 1/2", 1/4" | 53 | | | |
| Socket sets 1/2", 3/8", 1/4" Zestawy kluczy nasadowych 1/2", 3/8", 1/4" | 57 | Bit sockets & sets 1/4", 3/8", 1/2" Klucze trzpieniowe i zestawy 1/4", 3/8", 1/2" | 65-67 |  |
| Torx sockets & sets Klucze nasadowe „Torx” i zestawy | | | | |
| | 61-62 | | |  |
| Go-trough socket sets 1/2" Zestawy kluczy nasadowych, przelotowych 1/2" | | | | |
| | 62 | | |  |

GB Hexagonal socket
 D Sechskantenschlüssel
 PL Nasadka sześciokątna
 RUS Головка шестигранная короткая
 CZ Šestihranný nástavec
 H Hatszögű rátét
 RO Cheie tubulară hexagonală
 E Boquilla hexagonal corta
 CN 六角套筒

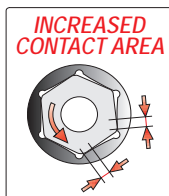

1/4"
 6.3mm
 DIN 3121
 CrV 50BV30
 AS-DRIVE

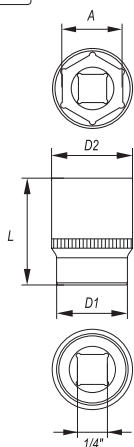

- drive locks
- surface finish: chromed, satin / mirror
- zamki blokujące
- wykończenie powierzchni: chromowana, satynowa / polerowana

| YATO | ∅ A (mm) | D1 (mm) | D2 (mm) | L (mm) | PCS packing | |
|---------|----------|---------|---------|--------|-------------|---------|
| YT-1401 | 4.0 | 7.0 | 12.0 | 25 | 20 | 200/400 |
| YT-1403 | 5.0 | 8.0 | 12.0 | 25 | 20 | 200/400 |
| YT-1404 | 5.5 | 8.5 | 12.0 | 25 | 20 | 200/400 |
| YT-1405 | 6.0 | 9.0 | 12.0 | 25 | 20 | 200/400 |
| YT-1406 | 7.0 | 10.0 | 12.0 | 25 | 20 | 200/400 |
| YT-1407 | 8.0 | 12.0 | 11.0 | 25 | 20 | 200/400 |
| YT-1408 | 9.0 | 13.0 | 12.0 | 25 | 20 | 200/400 |
| YT-1409 | 10.0 | 15.0 | 12.0 | 25 | 10 | 200/400 |
| YT-1410 | 11.0 | 16.0 | 14.0 | 25 | 10 | 200/400 |
| YT-1411 | 12.0 | 17.0 | 15.0 | 25 | 10 | 200/400 |
| YT-1412 | 13.0 | 18.0 | 16.0 | 25 | 10 | 200/400 |

GB Hexagonal deep socket
 D Sechskantenschlüssel, lange
 PL Nasadka sześciokątna długa
 RUS Головка шестигранная длинная
 CZ Šestihranný hluboký nástavec
 H Hatszögű rátét mély
 RO Cheie tubulară hexagonală adâncă
 E Boquilla hexagonal larga
 CN 六角长套筒

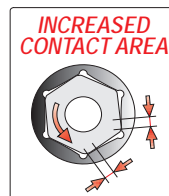

1/4"
 6.3mm
 DIN 3121
 CrV 50BV30
 AS-DRIVE

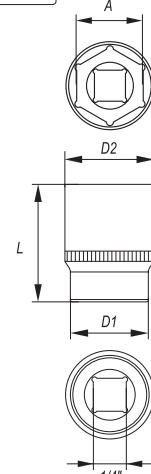

- drive locks
- surface finish: chromed, satin / mirror
- zamki blokujące
- wykończenie powierzchni: chromowana, satynowa / polerowana

| YATO | ∅ A (mm) | D1 (mm) | D2 (mm) | L (mm) | PCS packing | |
|---------|----------|---------|---------|--------|-------------|---------|
| YT-1413 | 4.0 | 7.0 | 12.0 | 50 | 10 | 200/400 |
| YT-1414 | 4.5 | 7.5 | 12.0 | 50 | 10 | 200/400 |
| YT-1415 | 5.0 | 8.0 | 12.0 | 50 | 10 | 200/400 |
| YT-1416 | 5.5 | 8.5 | 12.0 | 50 | 10 | 200/400 |
| YT-1417 | 6.0 | 9.0 | 12.0 | 50 | 10 | 200/400 |
| YT-1418 | 7.0 | 10.0 | 12.0 | 50 | 10 | 200/400 |
| YT-1419 | 8.0 | 12.0 | 12.0 | 50 | 10 | 200/400 |
| YT-1420 | 9.0 | 13.0 | 12.0 | 50 | 10 | 200/400 |
| YT-1421 | 10.0 | 14.0 | 13.0 | 50 | 10 | 200/400 |
| YT-1422 | 11.0 | 16.0 | 14.0 | 50 | 10 | 100/200 |
| YT-1423 | 12.0 | 17.0 | 15.0 | 50 | 10 | 100/200 |
| YT-1424 | 13.0 | 18.0 | 16.0 | 50 | 10 | 100/200 |

GB Extension bar
 D Verlängerung
 PL Przedłużka
 RUS Удлинитель для воротка
 CZ Prodlužovací přípravek
 H Toldalék
 RO Prelungitor
 E Tubo de prolongación
 CN 接杆

1/4"
 6.3mm
 DIN 3121
 CrV 50BV30

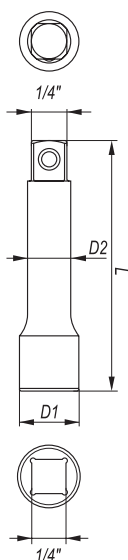

| YATO | ∅ | D1 (mm) | D2 (mm) | L (mm) | PCS packing | |
|---------|---------------|---------|---------|--------|-------------|---------|
| YT-1429 | 1/4" (6.3 mm) | 12.4 | 8.3 | 50.8 | 30 | 150/300 |
| YT-1430 | 1/4" (6.3 mm) | 12.4 | 8.3 | 76.0 | 30 | 150/300 |
| YT-1431 | 1/4" (6.3 mm) | 12.4 | 8.3 | 101.6 | 20 | 100/200 |
| YT-1432 | 1/4" (6.3 mm) | 12.4 | 8.3 | 152.4 | 20 | 100/200 |

GB Extension bar with wobble
 D Gelenkverlängerung
 PL Przedłużka uchylna
 RUS Удлинитель наклонный
 CZ Odchylný prodlužovací přípravek
 H Csuklós toldalék
 RO Prelungitor rabatabil
 E Tubo de prolongación desviable
 CN 转向接杆

1/4"
 6.3mm
 DIN 3121
 CrV 50BV30

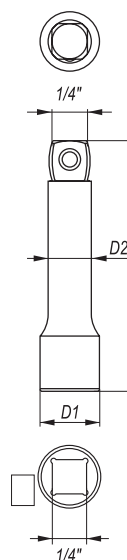

| YATO | ∅ | D1 (mm) | D2 (mm) | L (mm) | PCS packing | |
|---------|---------------|---------|---------|--------|-------------|---------|
| YT-1433 | 1/4" (6.3 mm) | 12.4 | 8.3 | 50.8 | 30 | 150/300 |
| YT-1434 | 1/4" (6.3 mm) | 12.4 | 8.3 | 76.0 | 30 | 150/300 |
| YT-1435 | 1/4" (6.3 mm) | 12.4 | 8.3 | 101.6 | 20 | 100/200 |
| YT-1436 | 1/4" (6.3 mm) | 12.4 | 8.3 | 152.4 | 20 | 100/200 |

GB Extension bar
 D Verlängerung
 PL Przedłużka elastyczna

RUS Удлинитель для воротка
 CZ Prodlužovací přípravek
 H Toldalék

RO Prelungitor
 E Tubo de prolongación
 CN 可弯式接杆

1/4"
6.3mm

CrV
6140

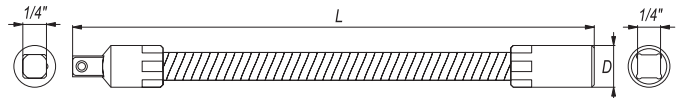

| YATO | Ø | Ø | D (mm) | L (mm) | PCS packing | |
|---------|---------------|---------------|--------|--------|-------------|---------|
| YT-1400 | 1/4" (6.3 mm) | 1/4" (6.3 mm) | 11.6 | 150 | 25 | 250/500 |

GB Adapter
 D Reduktion
 PL Redukcja
 RUS Переходник
 CZ Redukce
 H Redukció
 RO Reducție
 E Reducción
 CN 转换头

1/4"
6.3mm

DIN
3121

CrV
50BV30

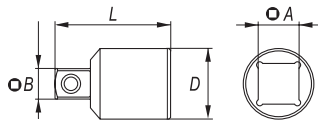

| YATO | Ø A | Ø B | D (mm) | L (mm) | PCS packing | |
|---------|-------------------|-------------------|--------|--------|-------------|---------|
| YT-1438 | 1/4" (6.3 mm) (F) | 3/8" (9.5 mm) (M) | 12 | 25 | 10 | 250/500 |

GB Bit adapter
 D Bithalter
 PL Adapter do bitów
 RUS Держатель винтовёртовых наконечников
 CZ Držák na šroubovakové koncovky
 H Szár a csavarhúzóvégekhez
 RO Capete şurubelniță
 E Mandril para puntas
 CN 旋具头接头

1/4"
6.3mm

CrV
6140

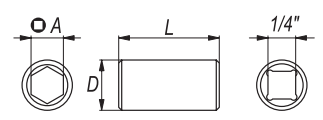

| YATO | Ø | Ø A | D (mm) | L (mm) | PCS packing | |
|---------|---------------|---------------|--------|--------|-------------|---------|
| YT-1297 | 1/4" (6.3 mm) | 1/4" (6.3 mm) | 11.8 | 24 | 10 | 250/500 |

GB Universal joint
 D Kardangeln
 PL Przegub Cardana
 RUS Карданный шарнир
 CZ Kardanový kloub

H Kardán csukló
 RO Articulație Cardanică
 E Articulación Cardan
 CN 万向接头

1/4"
6.3mm

DIN
3121

CrV
50BV30

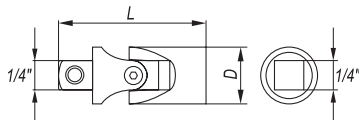

| YATO | Ø | D (mm) | L (mm) | PCS packing | |
|---------|---------------|--------|--------|-------------|---------|
| YT-1437 | 1/4" (6.3 mm) | 14 | 35 | 20 | 120/240 |

GB Spinner handle
 D Drehgriff für steckschlüssel
 PL Pokręto do nasadek
 RUS Ручка с соединением под головки
 CZ Nástavec ruční na bity

H Csavarhúzás hajtószár
 RO Prelungitor antrenor pt. biti
 E Destornillador con cuadrado
 CN 旋柄

1/4"
6.3mm

CrV
50BV30



| YATO | Ø | L (mm) | PCS packing | |
|---------|---------------|--------|-------------|----|
| YT-1427 | 1/4" (6.3 mm) | 150 | 12 | 48 |

GB Sliding T-bar
 D Handgriff mit Gleitstück
 PL Pokręto typu „T”
 RUS Вороток Т-образный

CZ Otočná ráčka typ „T”
 H „T” alakú hajtókar
 RO Mâner clupă tipul „T”
 E Mango tipo „T”
 CN 滑行杆

1/4"
6.3mm

DIN
3121

CrV
50BV30

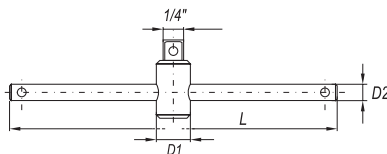

| YATO | Ø | D1 (mm) | D2 (mm) | L (mm) | PCS packing | |
|---------|---------------|---------|---------|--------|-------------|---------|
| YT-1426 | 1/4" (6.3 mm) | 13.3 | 6.3 | 152.4 | 10 | 100/200 |

GB Flexible handle
 D Gelenkgriff
 PL Pokręto lamane
 RUS Вороток шарнирный
 CZ Otočná lomená ráčka

H Hajított hajtókar
 RO Prelungitor cu prindere flexibilă
 E Mango articulado
 CN 转向手柄

1/4"
6.3mm

DIN
3121

CrV
50BV30

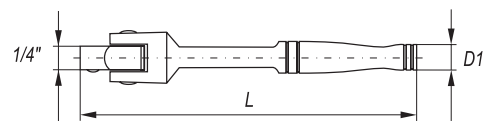

| YATO | Ø | D (mm) | L (mm) | PCS packing | |
|---------|---------------|--------|--------|-------------|---------|
| YT-1425 | 1/4" (6.3 mm) | 13 | 140 | 10 | 100/200 |

GB Quick release ratchet handle
D Hebelumschaltknarre
PL Grzechołka
RUS Трещотка
CZ Řehtačka

H Racsnis hajtókar
RO Dispozitiv de prindere cu clichet
E Carraca
CN 快速脱落棘轮扳手

PLASTIC HANGER



12 PCS



COLOR BOX

| | | |
|-------|----------|-----------------------------|
| 1/4" | DIN 3122 | QUICK RELEASE SZYBKO-ZŁĄCZE |
| 6.3mm | 72T | CrV 6140 |



| YATO | Ø | T | L (mm) | PCS packing: | Box |
|---------|---------------|----|--------|--------------|-------|
| YT-0307 | 1/4" (6.3 mm) | 72 | 146 | 12 | 24/96 |

| YATO | Ø | T | L (mm) | PCS packing: | Box |
|---------|---------------|----|--------|--------------|-------|
| YT-0310 | 1/4" (6.3 mm) | 72 | 125 | 12 | 36/72 |

| YATO | Ø | T | L (mm) | PCS packing: | Box |
|---------|---------------|----|--------|--------------|-------|
| YT-0313 | 1/4" (6.3 mm) | 72 | 125 | 12 | 24/96 |



| YATO | Ø | T | L (mm) | PCS packing: | Box |
|---------|---------------|----|--------|--------------|-------|
| YT-0316 | 1/4" (6.3 mm) | 72 | 145 | 12 | 24/96 |

| YATO | Ø | T | L (mm) | PCS packing: | Box |
|---------|---------------|----|--------|--------------|-------|
| YT-0319 | 1/4" (6.3 mm) | 72 | 145 | 12 | 48/96 |

| YATO | Ø | T | L (mm) | PCS packing: | Box |
|---------|---------------|----|--------|--------------|-------|
| YT-0322 | 1/4" (6.3 mm) | 72 | 148 | 12 | 48/96 |

GB Quick release ratchet handle
D Hebelumschaltknarre
PL Grzechołka
RUS Трещотка с шарниром
CZ Řehtačka

H Racsnis hajtókar
RO Dispozitiv de prindere cu clichet
E Carraca
CN 快速脱落棘轮扳手

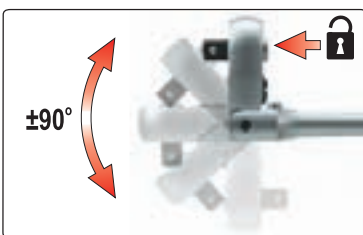

PLASTIC HANGER



12 PCS



COLOR BOX

| YATO | Ø | T | L (mm) | PCS packing: | Box |
|---------|---------------|----|--------|--------------|-------|
| YT-0325 | 1/4" (6.3 mm) | 72 | 159 | 12 | 48/96 |

GB Quick release ratchet handle
D Hebelumschaltknarre
PL Grzechołka powlekana
RUS Трещотка
CZ Řehtačka
H Racsnis hajtókar
RO Dispozitiv de prindere cu clichet
E Carraca
CN 快速脱落棘轮扳手

PLASTIC HANGER



12 PCS

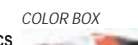

| | | |
|-------|----------|-----------------------------|
| 1/4" | DIN 3122 | QUICK RELEASE SZYBKO-ZŁĄCZE |
| 6.3mm | 72T | CrV 6135 |



| YATO | Ø | T | L (mm) | PCS packing: | Box |
|---------|---------------|----|--------|--------------|-------|
| YT-0290 | 1/4" (6.3 mm) | 72 | 144 | 12 | 48/96 |



| YATO | Ø | T | L (mm) | PCS packing: | Box |
|---------|---------------|----|--------|--------------|-------|
| YT-0293 | 1/4" (6.3 mm) | 72 | 144 | 12 | 48/96 |

GB Quick release ratchet handle
D Hebelumschaltknarre
PL Grzechołka
RUS Трещотка с шарниром
CZ Řehtačka
H Racsnis hajtókar
RO Dispozitiv de prindere cu clichet
E Carraca
CN 快速脱落棘轮扳手

PLASTIC HANGER



12 PCS



| | | |
|-------|----------|-----------------------------|
| 1/4" | DIN 3122 | QUICK RELEASE SZYBKO-ZŁĄCZE |
| 6.3mm | 72T | CrV 6140 |



| YATO | Ø | T | L (mm) | PCS packing: | Box |
|---------|---------------|----|--------|--------------|-------|
| YT-0730 | 1/4" (6.3 mm) | 72 | 155 | 12 | 24/96 |

GB Quick release ratchet handle
 D Hebelumschaltknarre
 PL Grzechotka
 RUS Трещотка с шарниром
 CZ Řehtačka
 H Racsnis hajtókar
 RO Dispozitiv de prindere cu clichet
 E Carraca
 CN 快速脱落棘轮扳手

PLASTIC HANGER 12 PCS COLOR BOX

1/4" QUICK RELEASE SZYBKO-ZŁĄCZE
 6.3mm
 72T CrV 6140



| YATO | Ø | T | L (mm) | PCS packing: | Box |
|----------|---------------|----|--------|--------------|-------|
| YT-07291 | 1/4" (6.3 mm) | 72 | 155 | 12 | 24/96 |

GB Quick release ratchet handle
 D Hebelumschaltknarre
 PL Grzechotka
 RUS Трещотка с шарниром
 CZ Řehtačka
 H Racsnis hajtókar
 RO Dispozitiv de prindere cu clichet
 E Carraca
 CN 快速脱落棘轮扳手

PLASTIC HANGER 12 PCS COLOR BOX

1/4" QUICK RELEASE SZYBKO-ZŁĄCZE
 6.3mm
 72T CrV 6135



| YATO | Ø | T | L (mm) | PCS packing: | Box |
|---------|---------------|----|--------|--------------|-------|
| YT-0733 | 1/4" (6.3 mm) | 72 | 155 | 12 | 24/96 |

GB Telescopic ratchet handle
 D Umschaltknarre
 PL Grzechotka z przedłużanym uchwytem
 RUS Трещотка
 CZ Řehtačka
 H Racsnis hajtókar
 RO Antrenor cu clichet
 E Carraca telescópico
 CN 可伸缩快速脱落棘轮扳手

PLASTIC HANGER 12 PCS COLOR BOX

1/4" QUICK RELEASE SZYBKO-ZŁĄCZE
 6.3mm
 72T CrV 6135



| YATO | Ø | T | L (mm) | PCS packing: | Box |
|---------|---------------|----|---------|--------------|-----|
| YT-0297 | 1/4" (6.3 mm) | 72 | 150-200 | 12 | 48 |

GB Ratchet handle and bit drive
 D Bit- und Steckschlüssel-Umschaltknarre
 PL Grzechotka do bitów i nasadek
 RUS Трещотка для битов и головок
 CZ Ráčna kombinovaná pro bity a nástrčné klíče
 H Bit és dugófej behajtó racsnis hajtókar
 RO Antrenor cu clichet / antrenor pt. biti
 E Carraca para boquillas y puntas
 CN 套筒旋具两用棘轮扳手

PLASTIC HANGER 12 PCS COLOR BOX

1/4" DIN 3122
 6.3mm
 QUICK RELEASE SZYBKO-ZŁĄCZE
 72T
 CrV 6140



| YATO | Ø | T | L (mm) | PCS packing: | Box |
|---------|---------------|----|--------|--------------|-----|
| YT-0331 | 1/4" (6.3 mm) | 72 | 136 | 12 | 48 |

GB Flexible ratchet handle / round head
 D Flexible Drehkopfratsche
 PL Grzechotka z obrotową głowicą
 RUS Трещотка с вращательной головкой
 CZ Ráčna s otočnou hlavou
 H Forgófejés racsnis szár
 RO Antrenor cu clichet flexibil
 E Carraca con cabeza giratoria
 CN 旋转头快速脱落棘轮扳手



PLASTIC HANGER 12 PCS COLOR BOX

1/4" DIN 3122
 6.3mm
 QUICK RELEASE SZYBKO-ZŁĄCZE
 72T
 CrV 6140

| YATO | Ø | T | L (mm) | PCS packing: | Box |
|---------|---------------|----|--------|--------------|-------|
| YT-0720 | 1/4" (6.3 mm) | 72 | 145 | 12 | 24/96 |

GB Hexagonal socket
 D Sechskantenschlüssel
 PL Nasadka sześciokątna
 RUS Головка шестигранная короткая
 CZ Sestihranný nástavec
 H Hatszögű rátét
 RO Cheie tubulară hexagonală
 E Boquilla hexagonal corta
 CN 六角套筒

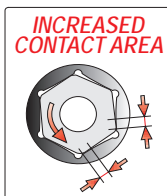
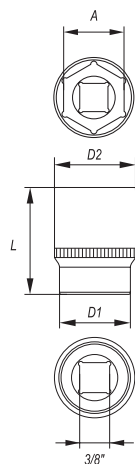

3/8" 10mm
 DIN 3121
 CrV 50BV30 AS-DRIVE

- drive locks
- surface finish: chromed, satin / mirror
- zamki blokujące
- wykończenie powierzchni: chromowana, satynowa / polerowana

COLOR BOX



| YATO | ∅ A (mm) | D1 (mm) | D2 (mm) | L (mm) | PCS packing | |
|---------|----------|---------|---------|--------|-------------|---------|
| YT-3801 | 6 | 10 | 17 | 28 | 10 | 250/500 |
| YT-3802 | 7 | 11 | 17 | 28 | 10 | 250/500 |
| YT-3803 | 8 | 12 | 17 | 28 | 10 | 250/500 |
| YT-3804 | 9 | 13 | 17 | 28 | 10 | 250/500 |
| YT-3805 | 10 | 14 | 17 | 28 | 10 | 250/500 |
| YT-3806 | 11 | 16 | 17 | 28 | 10 | 250/500 |
| YT-3807 | 12 | 18 | 17 | 28 | 10 | 250/500 |
| YT-3808 | 13 | 19 | 18 | 28 | 10 | 150/300 |
| YT-3809 | 14 | 20 | 19 | 28 | 10 | 150/300 |
| YT-3810 | 15 | 21 | 19 | 28 | 10 | 100/500 |
| YT-3811 | 16 | 22 | 21 | 28 | 10 | 100/500 |
| YT-3812 | 17 | 24 | 22 | 30 | 10 | 100/200 |
| YT-3813 | 18 | 25 | 23 | 30 | 10 | 100/200 |
| YT-3814 | 19 | 26 | 24 | 30 | 10 | 100/200 |

GB Hexagonal deep socket
 D Sechskantenschlüssel, lange
 PL Nasadka sześciokątna długa
 RUS Головка шестигранная длинная
 CZ Sestihranný hluboký nástavec
 H Hatszögű rátét mély
 RO Cheie tubulară hexagonală adâncă
 E Boquilla hexagonal larga
 CN 六角长套筒

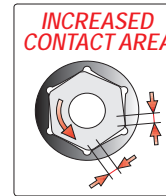
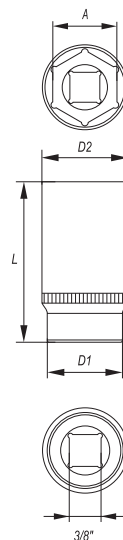

3/8" 10mm
 DIN 3121
 CrV 50BV30 AS-DRIVE

- drive locks
- surface finish: chromed, satin / mirror
- zamki blokujące
- wykończenie powierzchni: chromowana, satynowa / polerowana

COLOR BOX



| YATO | ∅ A (mm) | D1 (mm) | D2 (mm) | L (mm) | PCS packing | |
|---------|----------|---------|---------|--------|-------------|--------|
| YT-3820 | 6 | 10 | 17 | 63 | 10 | 50/100 |
| YT-3821 | 7 | 10 | 17 | 63 | 10 | 50/100 |
| YT-3822 | 8 | 12 | 17 | 63 | 10 | 50/100 |
| YT-3823 | 9 | 13 | 17 | 63 | 10 | 50/100 |
| YT-3824 | 10 | 14 | 17 | 63 | 10 | 50/100 |
| YT-3825 | 11 | 16 | 17 | 63 | 10 | 50/100 |
| YT-3826 | 12 | 18 | 17 | 63 | 10 | 50/100 |
| YT-3827 | 13 | 19 | 17 | 63 | 10 | 50/100 |
| YT-3828 | 14 | 20 | 19 | 63 | 10 | 50/100 |
| YT-3829 | 15 | 21 | 19 | 63 | 10 | 50/100 |
| YT-3830 | 16 | 22 | 20 | 63 | 10 | 50/100 |
| YT-3831 | 17 | 24 | 23 | 63 | 10 | 50/100 |
| YT-3832 | 18 | 25 | 23 | 63 | 10 | 50/100 |
| YT-3833 | 19 | 26 | 24 | 63 | 10 | 50/100 |

GB Extension bar
 D Verlängerung
 PL Przedłużka
 RUS Удлинитель для воротка
 CZ Prodlužovací přípravek
 H Toldalék
 RO Prelungitor
 E Tubo de prolongación
 CN 接杆

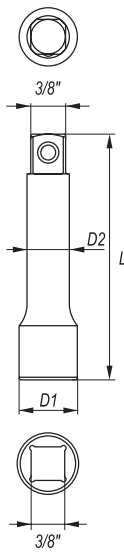

3/8" 10mm
 DIN 3121
 CrV 50BV30



| YATO | ∅ | D1 (mm) | D2 (mm) | L (mm) | PCS packing | |
|---------|---------------|---------|---------|--------|-------------|---------|
| YT-3842 | 3/8" (9.5 mm) | 18.0 | 12.3 | 42.0 | 10 | 100/200 |
| YT-3843 | 3/8" (9.5 mm) | 18.0 | 12.3 | 76.0 | 10 | 100/200 |
| YT-3844 | 3/8" (9.5 mm) | 18.0 | 12.3 | 152.4 | 10 | 50/100 |
| YT-3845 | 3/8" (9.5 mm) | 18.0 | 12.3 | 254.0 | 10 | 50 |

GB Extension bar with wobble
 D Gelenkverlängerung
 PL Przedłużka uchylna
 RUS Удлинитель наклонный
 CZ Odchylný prodlužovací přípravek
 H Csuklós toldalék
 RO Prelungitor rabatabil
 E Tubo de prolongación desviable
 CN 转向接杆

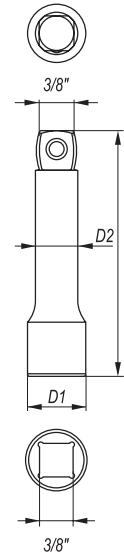

3/8" 10mm
 DIN 3121
 CrV 50BV30



| YATO | ∅ | D1 (mm) | D2 (mm) | L (mm) | PCS packing | |
|---------|---------------|---------|---------|--------|-------------|---------|
| YT-3846 | 3/8" (9.5 mm) | 18.0 | 12.3 | 40.0 | 10 | 100/200 |
| YT-3847 | 3/8" (9.5 mm) | 18.0 | 12.3 | 76.0 | 10 | 100/200 |
| YT-3848 | 3/8" (9.5 mm) | 18.0 | 12.3 | 152.4 | 10 | 50/100 |
| YT-3849 | 3/8" (9.5 mm) | 18.0 | 12.3 | 254.0 | 10 | 50 |

- GB Adapter
D Reduktion
PL Redukcja
RUS Переходник
CZ Redukce
H Redukció
RO Reducție
E Reducción
CN 转换头

3/8" 10mm
DIN 3121
CrV 50BV30

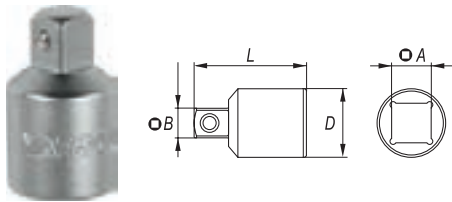

COLOR BOX

| YATO | Ø A | Ø B | D (mm) | L (mm) | PCS packing | Box |
|---------|-------------------|--------------------|--------|--------|-------------|---------|
| YT-3853 | 3/8" (9.5 mm) (F) | 1/4" (6.3 mm) (M) | 17 | 27 | 10 | 250/500 |
| YT-3854 | 3/8" (9.5 mm) (F) | 1/2" (12.7 mm) (M) | 17 | 35 | 10 | 100/200 |

- GB Universal joint
D Kardangelenk
PL Przegub Cardana
RUS Карданный шарнир
CZ Kardanový kloub

- H Kardán csukló
RO Articulație Cardanică
E Articulación Cardan
CN 万向接头

3/8" 10mm
DIN 3121
CrV 50BV30

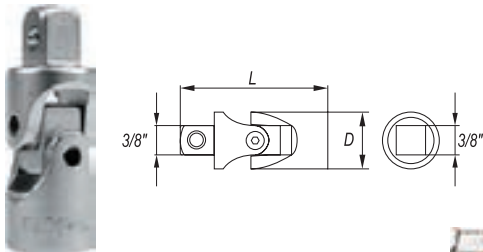

COLOR BOX

| YATO | Ø | D (mm) | L (mm) | PCS packing | Box |
|---------|---------------|--------|--------|-------------|---------|
| YT-3850 | 3/8" (9.5 mm) | 18 | 49 | 10 | 100/200 |

- GB Flexible handle
D Gelenkgriff
PL Pokrętko łamane
RUS Вороток шарнирный
CZ Otočná lomená ráčka
H Hajlított hajtókar
RO Prelungitor cu prindere flexibilă
E Mango articulado
CN 转向手柄

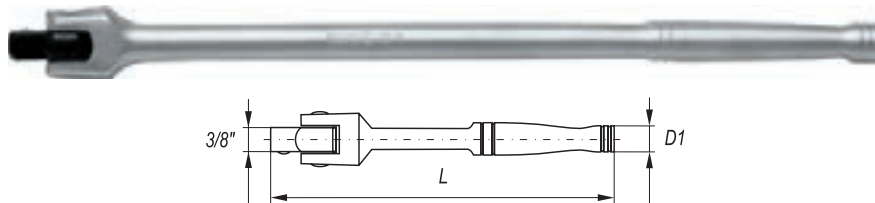

3/8" 10mm
DIN 3121
CrV 50BV30

COLOR BOX

| YATO | Ø | D (mm) | L (mm) | PCS packing | Box |
|---------|---------------|--------|--------|-------------|-------|
| YT-3839 | 3/8" (9.5 mm) | 16 | 215 | 8 | 24/48 |

- GB Spark plug socket
D Steckschlüssel mit Gummihalterung
PL Nasadka do świec
RUS Головка свечная

- CZ Nastavec pro svíčky
H Gyújtógyertya toldalék
RO Cheie de bujii
E Boquilla de bujías
CN 六角火花塞套筒

3/8" 10mm
DIN 3121
AS-DRIVE CrV 50BV30

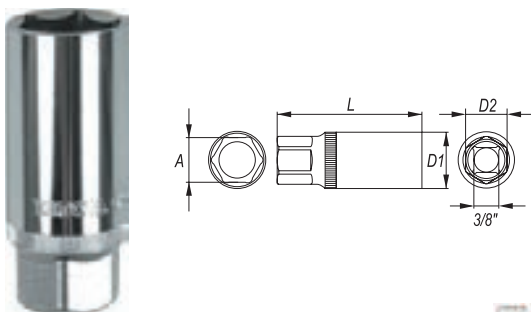

COLOR BOX

| YATO | Ø | A | D1 (mm) | D2 (mm) | L (mm) | PCS packing | Box |
|---------|---------------|------|---------|---------|--------|-------------|--------|
| YT-3851 | 3/8" (9.5 mm) | 16.0 | 22.0 | 19.0 | 64.0 | 10 | 50/100 |

- GB Bit adapter
D Bithalter
PL Adapter do bitów
RUS Держатель винтовёртовых наконечников
CZ Držák na šroubovakové koncovky
H Szár a csavarhúzóvégekhez
RO Capete şurubelniţă
E Mandril para puntas
CN 旋具头接头

3/8" 10mm
CrV 6140

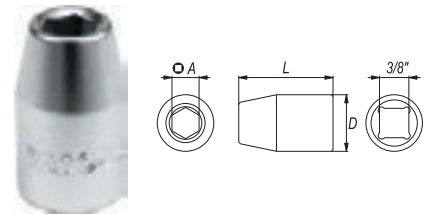

COLOR BOX

| YATO | Ø | Ø A | D (mm) | L (mm) | PCS packing | Box |
|---------|---------------|------|--------|--------|-------------|---------|
| YT-1296 | 3/8" (9.5 mm) | 8 mm | 17.9 | 30 | 10 | 250/500 |

- GB Sliding T-bar
D Handgriff mit Gleitstück
PL Pokrętko typu „T”

- RUS Вороток T-образный
CZ Otočná ráčka typ „T”
H „T” alakú hajtókar
RO Măner clupă tipul „T”
E Mango tipo „T”
CN 滑杆

3/8" 10mm

DIN 3121

CrV 50BV30

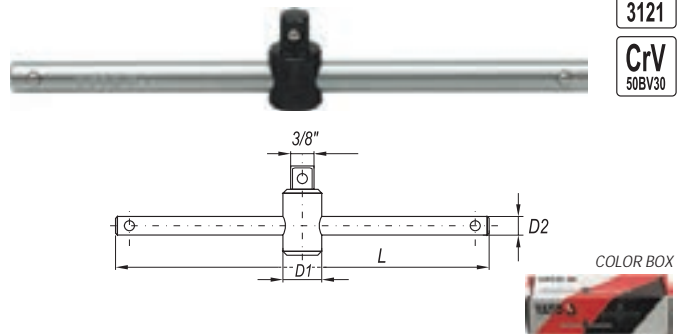

COLOR BOX

| YATO | Ø | D1 (mm) | D2 (mm) | L (mm) | PCS packing | Box |
|---------|---------------|---------|---------|--------|-------------|--------|
| YT-3840 | 3/8" (9.5 mm) | 20.0 | 10.7 | 198 | 10 | 50/100 |

- GB Spark plug socket
D Steckschlüssel mit Gummihalterung
PL Nasadka do świec
RUS Головка свечная

- CZ Nastavec pro svíčky
H Gyújtógyertya toldalék
RO Cheie de bujii
E Boquilla de bujías
CN 六角火花塞套筒

3/8" 10mm
DIN 3121
AS-DRIVE CrV 50BV30

- GB Spark plug socket
D Steckschlüssel mit Gummihalterung
PL Nasadka do świec
RUS Головка свечная

- CZ Nastavec pro svíčky
H Gyújtógyertya toldalék
RO Cheie de bujii
E Boquilla de bujías
CN 六角火花塞套筒

3/8" 10mm
DIN 3124
AS-DRIVE CrV 6140

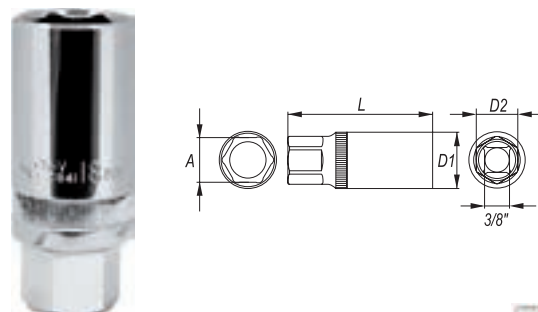

COLOR BOX

| YATO | Ø | A | D1 (mm) | D2 (mm) | L (mm) | PCS packing | Box |
|---------|---------------|------|---------|---------|--------|-------------|--------|
| YT-3841 | 3/8" (9.5 mm) | 18.0 | 25.8 | 19.0 | 63 | 25 | 50/100 |

GB Quick release ratchet handle
D Hebelumschaltknarre
PL Grzechołka
RUS Трещотка
CZ Řehtačka

H Racsnis hajtókar
RO Dispozitiv de prindere cu clichet
E Carraca
CN 快速脱落棘轮扳手

PLASTIC HANGER



6 PCS



COLOR BOX

3/8"
10mm

DIN
3122

QUICK
RELEASE
SZYBKO-
ZŁĄCZE

72T

CrV
6140



| YATO | Ø | T | L (mm) | PCS packing: | Box |
|---------|---------------|----|--------|--------------|-------|
| YT-0308 | 3/8" (9.5 mm) | 72 | 185 | 6 | 24/48 |

| YATO | Ø | T | L (mm) | PCS packing: | Box |
|---------|---------------|----|--------|--------------|-------|
| YT-0311 | 3/8" (9.5 mm) | 72 | 200 | 6 | 18/36 |

| YATO | Ø | T | L (mm) | PCS packing: | Box |
|---------|---------------|----|--------|--------------|-------|
| YT-0314 | 3/8" (9.5 mm) | 72 | 170 | 6 | 24/48 |



| YATO | Ø | T | L (mm) | PCS packing: | Box |
|---------|---------------|----|--------|--------------|-------|
| YT-0317 | 3/8" (9.5 mm) | 72 | 200 | 6 | 24/48 |

| YATO | Ø | T | L (mm) | PCS packing: | Box |
|---------|---------------|----|--------|--------------|-------|
| YT-0320 | 3/8" (9.5 mm) | 72 | 205 | 6 | 24/48 |

| YATO | Ø | T | L (mm) | PCS packing: | Box |
|---------|---------------|----|--------|--------------|-------|
| YT-0323 | 3/8" (9.5 mm) | 72 | 197 | 6 | 24/48 |

GB Quick release ratchet handle
D Hebelumschaltknarre
PL Grzechołka
RUS Трещотка с шарниром
CZ Řehtačka

H Racsnis hajtókar
RO Dispozitiv de prindere cu clichet
E Carraca
CN 快速脱落棘轮扳手

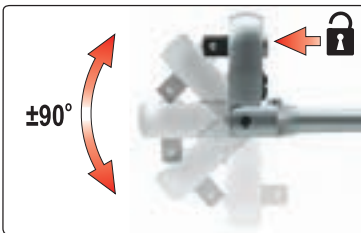

3/8"
10mm

QUICK
RELEASE
SZYBKO-
ZŁĄCZE

DIN
3122

72T

CrV
6140

PLASTIC HANGER



6 PCS



COLOR BOX

| YATO | Ø | T | L (mm) | PCS packing: | Box |
|---------|---------------|----|--------|--------------|-------|
| YT-0326 | 3/8" (9.5 mm) | 72 | 242 | 6 | 24/48 |

GB Quick release ratchet handle
D Hebelumschaltknarre
PL Grzechołka powlekana
RUS Трещотка
CZ Řehtačka
H Racsnis hajtókar
RO Dispozitiv de prindere cu clichet
E Carraca
CN 快速脱落棘轮扳手

PLASTIC HANGER



6 PCS



3/8"
10mm

DIN
3122

QUICK
RELEASE
SZYBKO-
ZŁĄCZE

72T

CrV
6135



| YATO | Ø | T | L (mm) | PCS packing: | Box |
|---------|---------------|----|--------|--------------|-------|
| YT-0291 | 3/8" (9.5 mm) | 72 | 202 | 6 | 24/48 |



| YATO | Ø | T | L (mm) | PCS packing: | Box |
|---------|---------------|----|--------|--------------|-------|
| YT-0294 | 3/8" (9.5 mm) | 72 | 202 | 6 | 24/48 |

GB Quick release ratchet handle
D Hebelumschaltknarre
PL Grzechołka
RUS Трещотка с шарниром
CZ Řehtačka
H Racsnis hajtókar
RO Dispozitiv de prindere cu clichet
E Carraca
CN 快速脱落棘轮扳手

PLASTIC HANGER



6 PCS



3/8"
10mm

QUICK
RELEASE
SZYBKO-
ZŁĄCZE

72T

CrV
6140



| YATO | Ø | T | L (mm) | PCS packing: | Box |
|---------|---------------|----|--------|--------------|-------|
| YT-0731 | 3/8" (9.5 mm) | 72 | 200 | 6 | 24/48 |

GB Quick release ratchet handle
 D Hebelumschaltknarre
 PL Grzechotka
 RUS Трещотка с шарниром
 CZ Řehtačka
 H Racsnis hajtókar
 RO Dispozitiv de prindere cu clichet
 E Carraca
 CN 快速脱落棘轮扳手

3/8"
 10mm
 72T
 CrV
 6140

GB Quick release ratchet handle
 D Hebelumschaltknarre
 PL Grzechotka
 RUS Трещотка с шарниром
 CZ Řehtačka
 H Racsnis hajtókar
 RO Dispozitiv de prindere cu clichet
 E Carraca
 CN 快速脱落棘轮扳手

3/8"
 10mm
 72T
 CrV
 6135

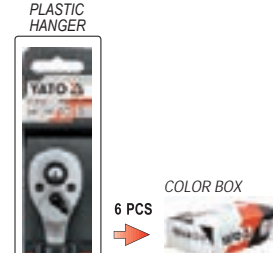

| YATO | Ø | T | L (mm) | PCS packing: | |
|----------|---------------|----|--------|--------------|-------|
| YT-07292 | 3/8" (9.5 mm) | 72 | 200 | 6 | 24/48 |

| YATO | Ø | T | L (mm) | PCS packing: | |
|---------|---------------|----|--------|--------------|-------|
| YT-0734 | 3/8" (9.5 mm) | 72 | 200 | 6 | 24/48 |

GB Telescopic ratchet handle
 D Umschaltknarre
 PL Grzechotka z przedłużanym uchwytem
 RUS Трещотка
 CZ Řehtačka
 H Racsnis hajtókar
 RO Antrenor cu clichet
 E Carraca telescópico
 CN 可伸缩快速脱落棘轮扳手



3/8"
 10mm
 72T
 CrV
 6135

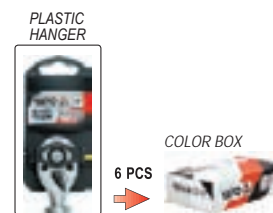

| YATO | Ø | T | L (mm) | PCS packing: | |
|---------|---------------|----|---------|--------------|----|
| YT-0298 | 3/8" (9.5 mm) | 72 | 215-315 | 6 | 24 |

GB Ratchet handle with traction belt
 D Ratsche mit Drehantriebsrad
 PL Grzechotka z paskiem transmisyjnym
 RUS Трещотка реверсионная
 CZ Ráčna s násobičom
 H Racsnis szár szíjhajtással
 RO Antrenor cu clichet cu tractiune pe curea
 E Carraca con cinta de transmisión
 CN 超快速脱落棘轮扳手



3/8"
 10mm
 QUICK RELEASE SZYBKO-ZŁĄCZE
 72T
 CrV
 6140

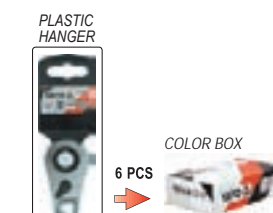

| YATO | Ø | T | L (mm) | PCS packing: | |
|---------|---------------|----|--------|--------------|-------|
| YT-0724 | 3/8" (9.5 mm) | 72 | 200 | 6 | 30/60 |

GB Hexagonal socket
D Sechskantenschlüssel
PL Nasadka sześciokątna
RUS Головка шестигранная короткая
CZ Šestihranný nástavec
H Hatszögű rátét
RO Cheie tubulară hexagonală
E Boquilla hexagonal corta
CN 六角套筒

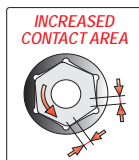

1/2" DIN 3121
12.5mm
CrV 50BV30 AS-DRIVE

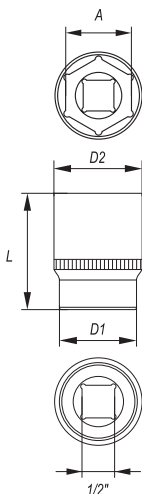

- drive locks
- surface finish: chromed, satin / mirror
- zamki blokujące
- wykończenie powierzchni: chromowana, satynowa / polerowana

COLOR BOX



| YATO | ∅ A (mm) | D1 (mm) | D2 (mm) | L (mm) | PCS packing | |
|---------|----------|---------|---------|--------|-------------|---------|
| YT-1201 | 8 | 12 | 22 | 38 | 10 | 100/200 |
| YT-1202 | 9 | 14 | 22 | 38 | 10 | 100/200 |
| YT-1203 | 10 | 15 | 22 | 38 | 10 | 100/200 |
| YT-1204 | 11 | 16 | 22 | 38 | 10 | 100/200 |
| YT-1205 | 12 | 18 | 22 | 38 | 10 | 100/200 |
| YT-1206 | 13 | 19 | 22 | 38 | 10 | 100/200 |
| YT-1207 | 14 | 20 | 22 | 38 | 10 | 100/200 |
| YT-1208 | 15 | 21 | 22 | 38 | 10 | 100/200 |
| YT-1209 | 16 | 23 | 22 | 38 | 10 | 100/200 |
| YT-1210 | 17 | 24 | 23 | 38 | 10 | 100/200 |
| YT-1211 | 18 | 25 | 23 | 38 | 10 | 100/200 |
| YT-1212 | 19 | 27 | 24 | 38 | 10 | 100/200 |
| YT-1213 | 20 | 28 | 24 | 38 | 10 | 100/200 |
| YT-1214 | 21 | 29 | 24 | 38 | 10 | 100/200 |
| YT-1215 | 22 | 30 | 26 | 38 | 10 | 100/200 |
| YT-1216 | 23 | 31 | 28 | 38 | 10 | 50/100 |
| YT-1217 | 24 | 32 | 28 | 38 | 10 | 50/100 |
| YT-1218 | 27 | 36 | 30 | 42 | 10 | 50/100 |
| YT-1219 | 30 | 40 | 34 | 42 | 10 | 50/100 |
| YT-1220 | 32 | 42 | 36 | 42 | 10 | 50/100 |

GB Bi-hexagonal socket
D Zwölfkant-Steckschlüssel-Einsatz
PL Nasadka dwunastokątna
RUS Головка 12-гранная
CZ Nástrčný ořech dvanáctihranný
H Dugófej, 12 lapú
RO Cheie tubulară bihexagonală
E Boquilla de anillo
CN 十二角套筒

1/2" DIN 3121
12.5mm
CrV 50BV30 AS-DRIVE

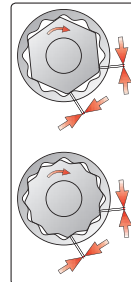
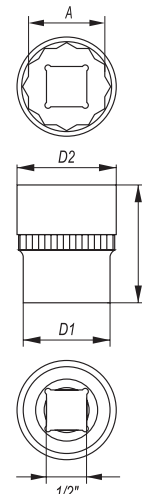

- drive locks
- surface finish: chromed, satin / mirror
- zamki blokujące
- wykończenie powierzchni: chromowana, satynowa / polerowana

COLOR BOX



| YATO | ∅ A (mm) | D1 (mm) | D2 (mm) | L (mm) | PCS packing | |
|---------|----------|---------|---------|--------|-------------|---------|
| YT-1270 | 8 | 12 | 22 | 38 | 10 | 100/200 |
| YT-1271 | 9 | 14 | 22 | 38 | 10 | 100/200 |
| YT-1272 | 10 | 15 | 22 | 38 | 10 | 100/200 |
| YT-1273 | 11 | 16 | 22 | 38 | 10 | 100/200 |
| YT-1274 | 12 | 17 | 22 | 38 | 10 | 100/200 |
| YT-1275 | 13 | 19 | 22 | 38 | 10 | 100/200 |
| YT-1276 | 14 | 20 | 22 | 38 | 10 | 100/200 |
| YT-1277 | 15 | 21 | 22 | 38 | 10 | 100/200 |
| YT-1278 | 16 | 23 | 22 | 38 | 10 | 100/200 |
| YT-1279 | 17 | 24 | 22 | 38 | 10 | 100/200 |
| YT-1280 | 18 | 25 | 23 | 38 | 10 | 100/200 |
| YT-1281 | 19 | 27 | 24 | 38 | 10 | 100/200 |
| YT-1282 | 20 | 28 | 24 | 38 | 10 | 100/200 |
| YT-1283 | 21 | 29 | 24 | 38 | 10 | 100/200 |
| YT-1284 | 22 | 30 | 26 | 38 | 10 | 100/200 |
| YT-1285 | 23 | 31 | 28 | 38 | 10 | 50/100 |
| YT-1286 | 24 | 32 | 28 | 38 | 10 | 50/100 |
| YT-1289 | 27 | 36 | 30 | 42 | 10 | 50/100 |
| YT-1291 | 30 | 40 | 34 | 42 | 10 | 50/100 |
| YT-1292 | 32 | 42 | 36 | 42 | 10 | 50/100 |

GB Spline socket
D Steckschlüssel Spline
PL Nasadka Spline
RUS Головка Spline
CZ Nástrčný klíč profil Spline
H Spline dugófej
RO Cheie tubulară cu stifturi
E Boquilla Spline
CN 花键型套筒

1/2" DIN 3121 CrV 50BV30

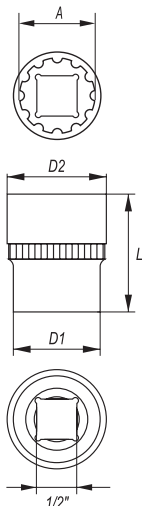
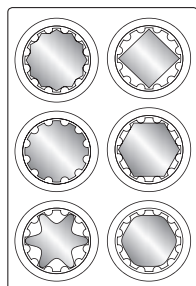

- drive locks
- enables to undo 5 types of screws
- allows to unscrew nuts damaged in 70%
- surface finish: chromed, satin / mirror
- zamki blokujące
- możliwość odkręcenia 5 rodzajów śrub
- możliwość odkręcenia nasadek zniszczonych w 70%
- wykończenie powierzchni: chromowana, satynowa / polerowana

COLOR BOX



| YATO | ∅ A (mm) | D1 (mm) | D2 (mm) | L (mm) | PCS packing | |
|---------|----------|---------|---------|--------|-------------|---------|
| YT-1460 | 8 | 13 | 22 | 38 | 10 | 100/200 |
| YT-1461 | 9 | 15 | 22 | 38 | 10 | 100/200 |
| YT-1462 | 10 | 16 | 22 | 38 | 10 | 100/200 |
| YT-1463 | 11 | 17 | 22 | 38 | 10 | 100/200 |
| YT-1464 | 12 | 18 | 22 | 38 | 10 | 100/200 |
| YT-1465 | 13 | 19 | 22 | 38 | 10 | 100/200 |
| YT-1466 | 14 | 20 | 22 | 38 | 10 | 100/200 |
| YT-1467 | 15 | 22 | 23 | 38 | 10 | 100/200 |
| YT-1468 | 16 | 23 | 22 | 38 | 10 | 100/200 |
| YT-1469 | 17 | 25 | 23 | 38 | 10 | 100/200 |
| YT-1470 | 18 | 26 | 23 | 38 | 10 | 100/200 |
| YT-1471 | 19 | 27 | 24 | 38 | 10 | 100/200 |
| YT-1472 | 20 | 28 | 24 | 38 | 10 | 100/200 |
| YT-1473 | 21 | 30 | 24 | 38 | 10 | 100/200 |
| YT-1474 | 22 | 31 | 26 | 38 | 10 | 100/200 |
| YT-1475 | 23 | 32 | 28 | 38 | 10 | 50/100 |
| YT-1476 | 24 | 34 | 28 | 38 | 10 | 50/100 |
| YT-1478 | 27 | 37 | 30 | 42 | 10 | 50/100 |
| YT-1480 | 30 | 41 | 34 | 42 | 10 | 50/100 |
| YT-1481 | 32 | 44 | 36 | 45 | 10 | 50/100 |

- GB Hexagonal deep socket
- D Sechskantenschlüssel, lange
- PL Nasadka sześciokątna długa
- RUS Головка шестигранная длинная
- CZ Sestihranný hluboký nástavec
- H Hatszögű rátét mély
- RO Cheie tubulară hexagonală adâncă
- E Boquilla hexagonal larga
- CN 六角长套筒

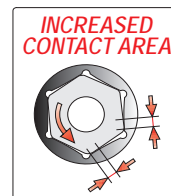
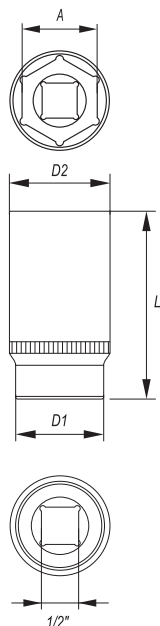

- 1/2" 12.5mm
- DIN 3121
- CrV 50BV30
- AS-DRIVE

- drive locks
- surface finish: chromed, satin / mirror
- zamki blokujące
- wykończenie powierzchni: chromowana, satynowa / polerowana

COLOR BOX



| YATO | ∅ A (mm) | D1 (mm) | D2 (mm) | L (mm) | PCS packing: | |
|---------|----------|---------|---------|--------|--------------|--------|
| YT-1221 | 8 | 13 | 22 | 76 | 10 | 50/100 |
| YT-1222 | 9 | 14 | 22 | 76 | 10 | 50/100 |
| YT-1223 | 10 | 15 | 22 | 76 | 10 | 50/100 |
| YT-1224 | 11 | 17 | 22 | 76 | 10 | 50/100 |
| YT-1225 | 12 | 18 | 22 | 76 | 10 | 50/100 |
| YT-1226 | 13 | 19 | 22 | 76 | 10 | 50/100 |
| YT-1227 | 14 | 20 | 22 | 76 | 10 | 50/100 |
| YT-1228 | 15 | 21 | 22 | 76 | 10 | 50/100 |
| YT-1229 | 16 | 24 | 22 | 76 | 10 | 50/100 |
| YT-1230 | 17 | 24 | 22 | 76 | 10 | 50/100 |
| YT-1231 | 18 | 25 | 23 | 76 | 10 | 50/100 |
| YT-1232 | 19 | 27 | 24 | 76 | 10 | 50/100 |
| YT-1233 | 20 | 28 | 24 | 76 | 10 | 50/100 |
| YT-1234 | 21 | 29 | 24 | 76 | 10 | 50/100 |
| YT-1235 | 22 | 30 | 26 | 76 | 10 | 50/100 |
| YT-1236 | 23 | 31 | 28 | 76 | 10 | 50/100 |
| YT-1237 | 24 | 32 | 28 | 76 | 10 | 50/100 |
| YT-1238 | 27 | 36 | 30 | 76 | 10 | 50 |
| YT-1239 | 30 | 40 | 36 | 76 | 10 | 20/40 |
| YT-1240 | 32 | 42 | 38 | 76 | 10 | 20/40 |

- GB Extension bar
- D Verlängerung
- PL Przedłużka
- RUS Удлинитель для воротка
- CZ Prodlužovací přípravek
- H Toldalék
- RO Prelungitor
- E Tubo de prolongación
- CN 接杆

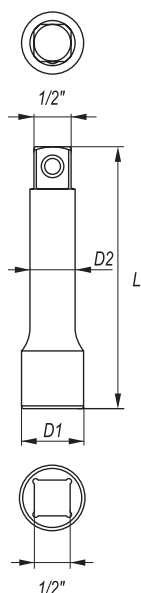

- 1/2" 12.5mm
- DIN 3121
- CrV 50BV30

COLOR BOX



| YATO | ∅ | D1 (mm) | D2 (mm) | L (mm) | PCS packing: | |
|---------|----------------|---------|---------|--------|--------------|--------|
| YT-1246 | 1/2" (12.7 mm) | 24.0 | 14.5 | 76 | 15 | 30/120 |
| YT-1247 | 1/2" (12.7 mm) | 24.0 | 14.5 | 127 | 5 | 20/80 |
| YT-1248 | 1/2" (12.7 mm) | 24.0 | 14.5 | 254 | 5 | 20/40 |

- GB Extension bar with wobble
- D Gelenverlängerung
- PL Przedłużka uchylna
- RUS Удлинитель наклонный
- CZ Odchylný prodlužovací přípravek
- H Csuklós toldalék
- RO Prelungitor rabatabil
- E Tubo de prolongación desviable
- CN 转向接杆

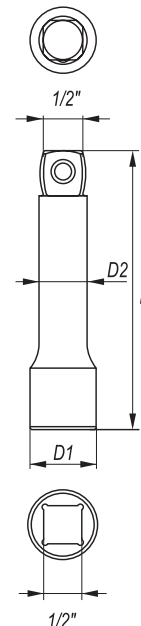

- 1/2" 12.5mm
- DIN 3121
- CrV 50BV30

COLOR BOX



| YATO | ∅ | D1 (mm) | D2 (mm) | L (mm) | PCS packing: | |
|---------|----------------|---------|---------|--------|--------------|--------|
| YT-1249 | 1/2" (12.7 mm) | 24.0 | 14.5 | 76 | 15 | 30/120 |
| YT-1250 | 1/2" (12.7 mm) | 24.0 | 14.5 | 127 | 5 | 20/80 |
| YT-1251 | 1/2" (12.7 mm) | 24.0 | 14.5 | 254 | 5 | 20/40 |

GB Adapter
D Reduktion
PL Redukcja

RUS Переходник
CZ Redukce
H Redukció

RO Reducție
E Reducción
CN 转换头

1/2" 12.5mm
3/4" 19mm
DIN 3121
CrV 50BV30

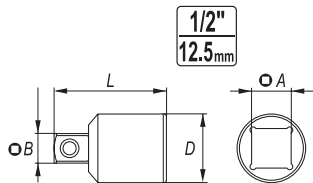

COLOR BOX

| YATO | OA | OB | D (mm) | L (mm) | PCS packing: | |
|---------|--------------------|--------------------|--------|--------|--------------|---------|
| YT-1255 | 1/2" (12.7 mm) (F) | 3/8" (9.5 mm) (M) | 22 | 34.0 | 10 | 100/200 |
| YT-1258 | 1/2" (12.7 mm) (F) | 3/4" (19.0 mm) (M) | 27 | 45.5 | 10 | 50/100 |
| YT-1259 | 3/4" (19.0 mm) (F) | 1/2" (12.7 mm) (M) | 35 | 51.0 | 5 | 50/100 |
| YT-1356 | 1/2" (12.7 mm) (F) | 3/4" (19.0 mm) (M) | 26 | 48.0 | 12 | 48 |

GB Universal joint
D Kardangelenk
PL Przegub Cardana
RUS Карданный шарнир
CZ Kardanový kloub

H Kardán csukló
RO Articulație Cardanică
E Articulación Cardan
CN 万向接头

1/2" 12.5mm
DIN 3121
CrV 50BV30

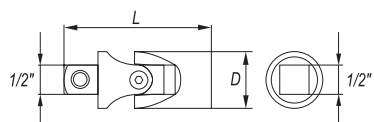

COLOR BOX

| YATO | Ø | D (mm) | L (mm) | PCS packing: | |
|---------|----------------|--------|--------|--------------|--------|
| YT-1252 | 1/2" (12.7 mm) | 25 | 69 | 5 | 50/100 |

GB Bit adapter
D Bithalter
PL Adapter do bitów

H Szár a csavarhúzóvégekhöz
RO Capete șurubelniță
E Mandril para puntas
CN 旋具头接头

1/2" 12.5mm
CrV 6140

RUS Держатель винтовёртовых наконечников
CZ Držák a šroubovákové koncovky

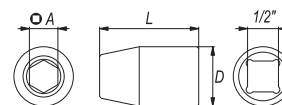

COLOR BOX

| YATO | Ø | OA | D (mm) | L (mm) | PCS packing: | |
|---------|----------------|------|--------|--------|--------------|---------|
| YT-1295 | 1/2" (12.7 mm) | 8 mm | 21.9 | 38 | 10 | 250/500 |

GB Sliding T-bar
D Handgriff mit Gleitstück
PL Pokręto typu „T”

RUS Вороток T-образный
CZ Otočná ráčká typ „T”
H „T” alakú hajtókar
E Mango tipo „T”
CN 滑行杆

1/2" 12.5mm

DIN 3121

CrV 50BV30

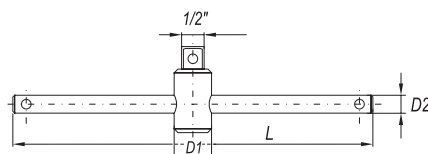

COLOR BOX

| YATO | Ø | D1 (mm) | D2 (mm) | L (mm) | PCS packing: | |
|---------|----------------|---------|---------|--------|--------------|-------|
| YT-1243 | 1/2" (12.7 mm) | 24.0 | 13.5 | 255 | 4 | 24/48 |

GB Flexible handle
D Gelenkgriff
PL Pokręto łamane
RUS Вороток шарнирный
CZ Otočná lomená ráčká
H Hajlított hajtókar
RO Prelungitor cu prindere flexibilă
E Mango articulado
CN 转向手柄

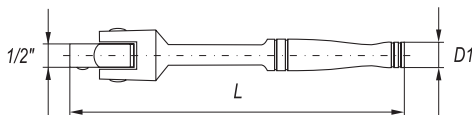

COLOR BOX

| YATO | Ø | D (mm) | L (mm) | PCS packing: | |
|---------|----------------|--------|--------|--------------|-------|
| YT-1241 | 1/2" (12.7 mm) | 19 | 360 | 5 | 15/30 |
| YT-1242 | 1/2" (12.7 mm) | 20 | 457 | 5 | 10/20 |

GB L-type handle
D Admutternschlüssel
PL Pokręto typu „L”
RUS Вороток 1/2" тип „L”
CZ Páka zahnutá
H „L” alakú hajtókar
RO Măner clupă tipul „L”
E Mango tipo „L”
CN L型套筒扳手



COLOR BOX

| YATO | Ø | D (mm) | L (mm) | PCS packing: | |
|---------|----------------|--------|--------|--------------|----|
| YT-1244 | 1/2" (12.7 mm) | 16.5 | 317 | 3 | 36 |

GB Spark plug socket
D Steckschlüssel mit Gummihalterung
PL Nasadka do świec
RUS Головка свечная
CZ Nastavec pro svíčky
H Gyújtógyertya toldalék
RO Cheie de bujii
E Boquilla de bujías
CN 火花塞套筒

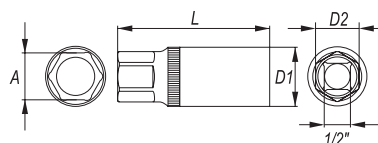

COLOR BOX

| YATO | Ø | A | D1 (mm) | D2 (mm) | L (mm) | PCS packing: | |
|---------|----------------|------|---------|---------|--------|--------------|--------|
| YT-1253 | 1/2" (12.7 mm) | 16.0 | 22.0 | 19.0 | 64.0 | 10 | 50/100 |
| YT-1254 | 1/2" (12.7 mm) | 21.0 | 27.8 | 24.0 | 64.0 | 10 | 50/100 |

GB Quick release ratchet handle
D Hebelumschaltknarre
PL Grzechotka
RUS Трещотка
CZ Řehtačka

H Racsnis hajtókar
RO Dispozitiv de prindere cu clichet
E Carraca
CN 快速脱落棘轮扳手

PLASTIC HANGER



6 PCS



COLOR BOX

1/2"
12.5mm

DIN
3122

QUICK
RELEASE
SZYBKO-
ZŁĄCZE

72T

CrV
6140



| YATO | Ø | T | L (mm) | PCS packing | Box |
|---------|----------------|----|--------|-------------|-----|
| YT-0309 | 1/2" (12.7 mm) | 72 | 278 | 6 | 24 |

| YATO | Ø | T | L (mm) | PCS packing | Box |
|---------|----------------|----|--------|-------------|-------|
| YT-0312 | 1/2" (12.7 mm) | 72 | 250 | 6 | 12/24 |

| YATO | Ø | T | L (mm) | PCS packing | Box |
|---------|----------------|----|--------|-------------|-----|
| YT-0315 | 1/2" (12.7 mm) | 72 | 250 | 6 | 24 |



| YATO | Ø | T | L (mm) | PCS packing | Box |
|---------|----------------|----|--------|-------------|-----|
| YT-0318 | 1/2" (12.7 mm) | 72 | 250 | 6 | 24 |

| YATO | Ø | T | L (mm) | PCS packing | Box |
|---------|----------------|----|--------|-------------|-----|
| YT-0321 | 1/2" (12.7 mm) | 72 | 255 | 6 | 24 |

| YATO | Ø | T | L (mm) | PCS packing | Box |
|---------|----------------|----|--------|-------------|-----|
| YT-0324 | 1/2" (12.7 mm) | 72 | 265 | 6 | 24 |

GB Quick release ratchet handle
D Hebelumschaltknarre
PL Grzechotka
RUS Трещотка с шарниром
CZ Řehtačka

H Racsnis hajtókar
RO Dispozitiv de prindere cu clichet
E Carraca
CN 快速脱落棘轮扳手

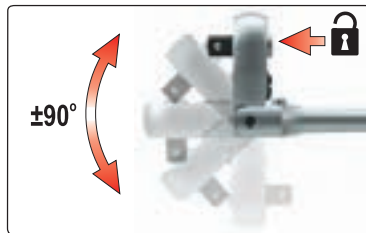

1/2"
12.5mm

QUICK
RELEASE
SZYBKO-
ZŁĄCZE

DIN
3122

72T

CrV
6140

PLASTIC HANGER



6 PCS



COLOR BOX

| YATO | Ø | T | L (mm) | PCS packing | Box |
|---------|----------------|----|--------|-------------|-----|
| YT-0327 | 1/2" (12.7 mm) | 72 | 290 | 6 | 24 |

GB Quick release ratchet handle
D Hebelumschaltknarre
PL Grzechotka powlekana
RUS Трещотка
CZ Řehtačka
H Racsnis hajtókar
RO Dispozitiv de prindere cu clichet
E Carraca
CN 快速脱落棘轮扳手

PLASTIC HANGER



6 PCS



1/2"
12.5mm

DIN
3122

QUICK
RELEASE
SZYBKO-
ZŁĄCZE

72T

CrV
6135



| YATO | Ø | T | L (mm) | PCS packing | Box |
|---------|----------------|----|--------|-------------|-----|
| YT-0292 | 1/2" (12.7 mm) | 72 | 257 | 6 | 24 |



| YATO | Ø | T | L (mm) | PCS packing | Box |
|---------|----------------|----|--------|-------------|-----|
| YT-0295 | 1/2" (12.7 mm) | 72 | 257 | 6 | 24 |

GB Quick release ratchet handle
D Hebelumschaltknarre
PL Grzechotka
RUS Трещотка с шарниром
CZ Řehtačka
H Racsnis hajtókar
RO Dispozitiv de prindere cu clichet
E Carraca
CN 快速脱落棘轮扳手

PLASTIC HANGER



6 PCS



1/2"
12.5mm

QUICK
RELEASE
SZYBKO-
ZŁĄCZE

72T

CrV
6140



| YATO | Ø | T | L (mm) | PCS packing | Box |
|---------|----------------|----|--------|-------------|-----|
| YT-0732 | 1/2" (12.7 mm) | 72 | 255 | 6 | 24 |

- GB Quick release ratchet handle
D Hebelumschaltknarre
PL Grzechotka
RUS Трещотка с шарниром
CZ Řehtačka
H Racsnis hajtókar
RO Dispozitiv de prindere cu clichet
E Carraca
CN 快速脱落棘轮扳手

1/2"
12.5mm
72T
CrV
6140



PLASTIC HANGER



COLOR BOX



| YATO | Ø | T | L (mm) | PCS packing: | Box |
|----------|----------------|----|--------|--------------|-----|
| YT-07293 | 1/2" (12.7 mm) | 72 | 255 | 6 | 24 |

- GB Quick release ratchet handle
D Hebelumschaltknarre
PL Grzechotka
RUS Трещотка с шарниром
CZ Řehtačka
H Racsnis hajtókar
RO Dispozitiv de prindere cu clichet
E Carraca
CN 快速脱落棘轮扳手

1/2"
12.5mm
72T
CrV
6135



PLASTIC HANGER



COLOR BOX



| YATO | Ø | T | L (mm) | PCS packing: | Box |
|---------|----------------|----|--------|--------------|-----|
| YT-0735 | 1/2" (12.7 mm) | 72 | 255 | 6 | 24 |

- GB Telescopic ratchet handle
D Umschaltknarre
PL Grzechotka z przedłużanym uchwytem
RUS Трещотка
CZ Řehtačka
H Racsnis hajtókar
RO Antrenor cu clichet
E Carraca telescópico
CN 可伸缩快速脱落棘轮扳手



1/2"
12.5mm
72T
CrV
6135



PLASTIC HANGER



COLOR BOX



| YATO | Ø | T | L (mm) | PCS packing: | Box |
|---------|----------------|----|---------|--------------|-----|
| YT-0299 | 1/2" (12.7 mm) | 72 | 305-445 | 6 | 24 |

- GB Flexible ratchet handle / round head
D Flexible Drehkopfratsche
PL Grzechotka z obrotową głowicą
RUS Трещотка с вращательной головкой
CZ Ráčna s otočnou hlavou
H Forgófejés racsnis szár
RO Antrenor cu clichet flexibil
E Carraca con cabeza giratoria
CN 旋转头快速脱落棘轮扳手



PLASTIC HANGER



COLOR BOX



| YATO | Ø | T | L (mm) | PCS packing: | Box |
|---------|----------------|----|--------|--------------|-----|
| YT-0722 | 1/2" (12.7 mm) | 72 | 280 | 6 | 30 |

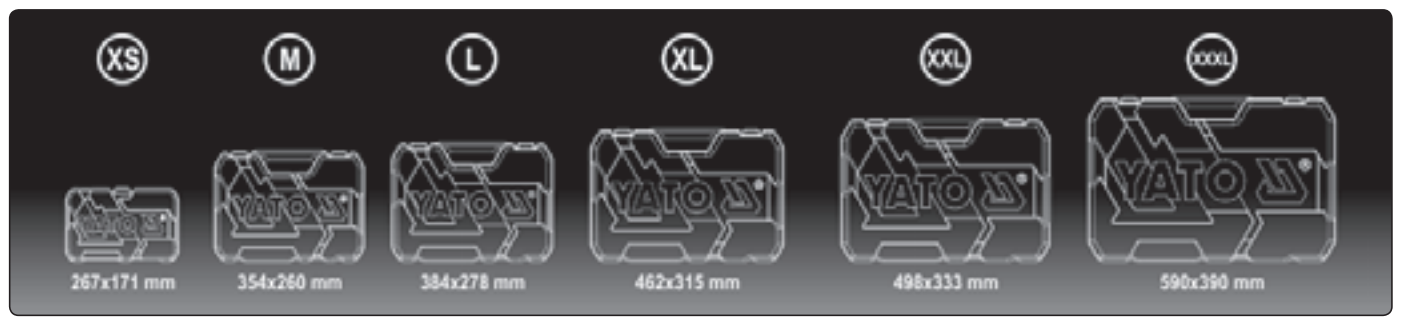

GB Socket set

D Sechskant-Steckschlüssel-Satz

PL Komplet nasadek długich

RUS Набор насадок

CZ Sada nástrčných klíčů

H Dugókulcs készlet

RO Trusă chei tubulare

E Juego de herramientas

CN 长套筒组套

PLASTIC HANGER



10 PCS 1/2" 12.5mm

CrV 50BV30 AS-DRIVE



1/2" (12.7 mm): 10, 12, 13, 14, 15, 17, 19, 21, 22, 24 mm (L=76 mm); CrV 50BV30

| | | |
|-------------|----------------|------|
| YATO | ○ | |
| YT-38861 | 1/2" (12.7 mm) | 5/10 |

GB Socket set

D Sechskantenschlüssel-Einsatz

PL Komplet nasadek z akcesoriami

RUS Набор торцевых головок

CZ Sada nástrčných klíčů a ráčny

H Dugókulcs készlet racsnis hajtókarral

RO Trusă chei tubulare cu antrenor

E Juego de boquillas con accesorios

CN 套筒扳手组套

PLASTIC HANGER



12 PCS 1/2" 12.5mm CrV 50BV30

CrMo 440 72T AS-DRIVE



1/2" (12.7 mm): 10, 11, 12, 13, 14, 15, 17, 19, 21, 24 mm (L=38 mm); CrV 50BV30;
 1/2" (12.7 mm): (127 mm); CrV 50BV30;
 1/2" (12.7 mm): (255 mm); 72T; CrMo 440

| | | |
|-------------|----------------|------|
| YATO | ○ | |
| YT-38821 | 1/2" (12.7 mm) | 5/10 |

GB Ratchet handle with socket set

D Sechskant-Steckschlüssel-Satz

PL Komplet nasadek z grzechotką

RUS Набор насадок

CZ Sada nástrčných klíčů a ráčny

H Dugókulcs készlet racsnis hajtókarral

RO Rotrusă chei tubulare cu antrenor

E Matraca con boquillas

CN 套筒扳手组套

PLASTIC HANGER



19 PCS 1/2" 12.5mm CrV 50BV30

CrMo 440 72T AS-DRIVE



1/2" (12.7 mm): 8, 9, 10, 11, 12, 13, 14, 15, 16, 17, 19, 21, 22, 23, 24 mm (L=38 mm);
 27, 30, 32 mm (L=42 mm); CrV 50BV30;
 1/2" (12.7 mm): (255 mm); 72T; CrMo 440

| | | |
|-------------|----------------|-----|
| YATO | ○ | |
| YT-38681 | 1/2" (12.7 mm) | 3/6 |

GB Socket set
D Sechskant-Steckschlüssel-Satz
PL Komplet nasadek dlugich

RUS Набор насадок
CZ Sada nástrčných klíčů
H Dugókulcs készlet

RO Trusă de chei tubulare
E Juego de herramientas
CN 套筒扳手组套

BMC & COLOR SLEEVE
XL SIZE



| | | |
|----------------|---------------|---------------|
| 1/2" 12.5mm | 3/8" 10mm | 1/4" 6.3mm |
| CrV 6150 | CrV 50BV30 | CrMo 440 |
| S2 | 72T | AS-DRIVE |

2

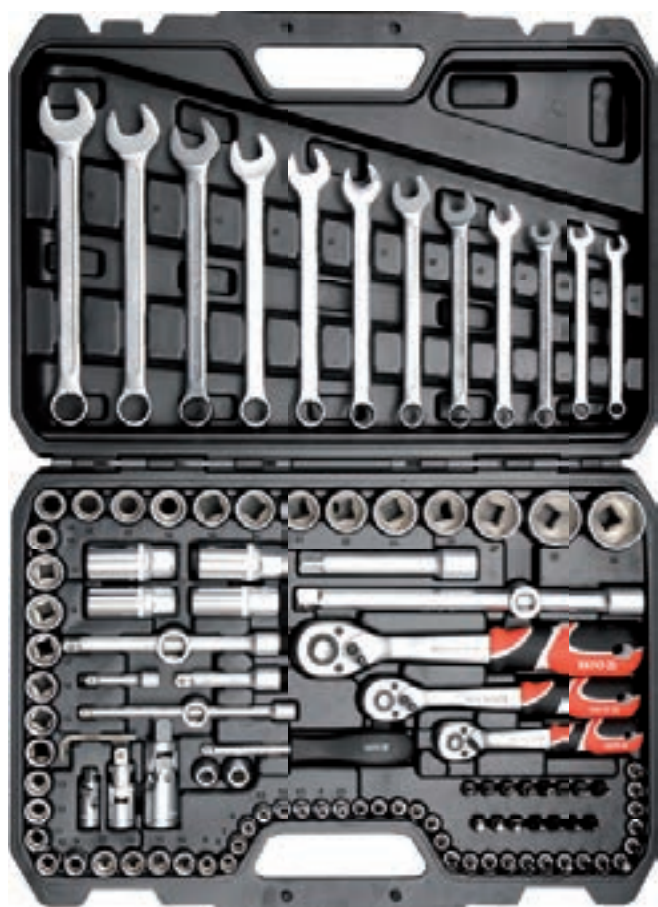

111
PCS

1/2" (12.7 mm): 14, 15, 16, 17, 18, 19, 20, 21, 22, 23, 24 mm (L=38 mm); 27, 30, 32 mm (L=42 mm); 3/8" (9.5 mm): 9, 10, 11, 12, 13, 14, 15, 16 mm (L=28 mm); 17, 18, 19 mm (L=30 mm); 1/4" (6.3 mm): 3.5, 4, 4.5, 5, 5.5, 6, 7, 8, 9, 10, 11, 12, 13 mm (L=25 mm); CrV 50BV30: 1/2" (12.7 mm): (127, 254 mm); 3/8" (9.5 mm): (76, 152.4 mm); 1/4" (6.3 mm): (50.8, 152.4 mm); CrV 50BV30: 3/8" (9.5 mm) (F) x 1/2" (12.7 mm) (M), 1/2" (12.7 mm) (F) x 3/8" (9.5 mm) (M), 3/8" (9.5 mm) (F) x 1/4" (6.3 mm) (M); CrV 50BV30: 1/2" (12.7 mm), 3/8" (9.5 mm), 1/4" (6.3 mm); CrV 50BV30: 1/2" (12.7 mm): 16, 21 mm, 3/8" (9.5 mm): 16, 21 mm; CrV 50BV30: 1/2" (12.7 mm): (255 mm), 3/8" (9.5 mm): (200 mm), 1/4" (6.3 mm): (155 mm); 72T: CrMo 440: 1/4" (6.3 mm): (150 mm); CrV 50BV30: 1/2" (12.7 mm) x 5/16" (7.9 mm), 3/8" (9.5 mm) x 5/16" (7.9 mm); CrV 50BV30: 5/16" (7.9 mm): 6, 6.5, 8 mm (L=30 mm); AISI S2: 5/16" (7.9 mm): PH2, PH3 (L=30 mm); AISI S2: 5/16" (7.9 mm): PZ2, PZ3 (L=30 mm); AISI S2: 5/16" (7.9 mm): T27, T30, T35, T40, T45 (L=30 mm); AISI S2: 5/16" (7.9 mm): 5.5, 6, 6.5 mm (L=30 mm); AISI S2: 1/4" (6.3 mm): 4, 5.5, 6.5 mm (L=37 mm); AISI S2 / CrV 6150: 1/4" (6.3 mm): PH1, PH2 (L=37 mm); AISI S2 / CrV 6150: 1/4" (6.3 mm): PZ1, PZ2 (L=37 mm); AISI S2 / CrV 6150: 1/4" (6.3 mm): T8, T10, T15, T20, T25 (L=37 mm); AISI S2 / CrV 6150: 1/4" (6.3 mm): T10, T15, T20, T25, T40 (L=37 mm); AISI S2 / CrV 6150: 1/4" (6.3 mm): 3, 4, 5, 6 mm (L=37 mm); AISI S2 / CrV 6150: 8, 9, 10, 11, 12, 13, 14, 15, 16, 17, 18, 19 mm; CrV: 1.5, 2, 2.5 mm; CrV 6150

| YATO | 1/2" (12.7 mm) | 3/8" (9.5 mm) | 1/4" (6.3 mm) | 2 |
|----------|----------------|---------------|---------------|---|
| YT-38831 | 1/2" (12.7 mm) | 3/8" (9.5 mm) | 1/4" (6.3 mm) | 2 |

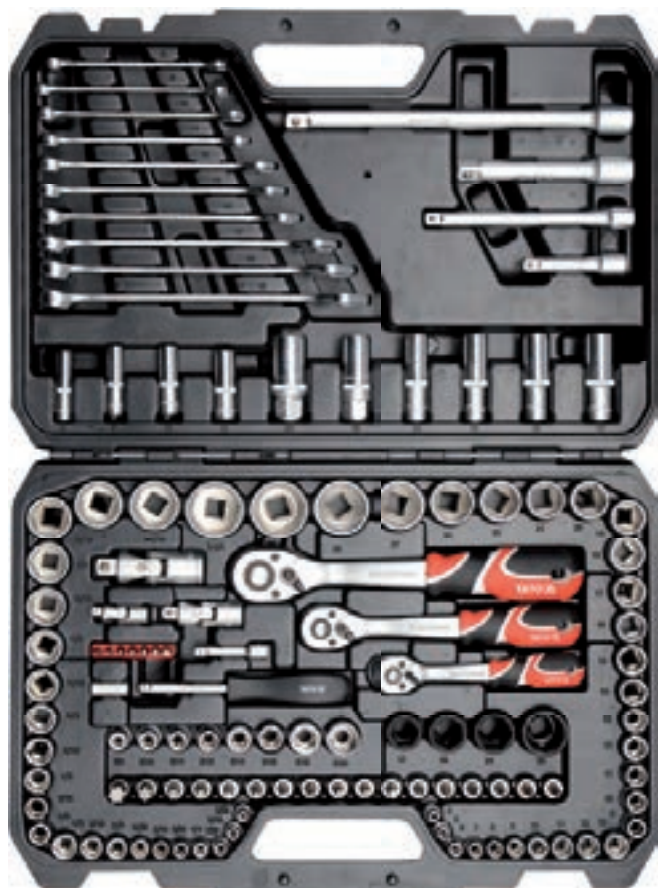

120
PCS METRIC & S.A.E.

1/2" (12.7 mm): 20, 21, 22, 24 mm (L=38 mm); 27, 30, 32 mm (L=42 mm); 3/8" (9.5 mm): 9, 10, 11, 12, 13, 14, 15, 16 mm (L=28 mm); 17, 18, 19 mm (L=30 mm); 1/4" (6.3 mm): 4, 5, 6, 7, 8, 9, 10, 11, 12, 13 mm (L=25 mm); CrV 50BV30: 3/8" (9.5 mm): 13, 14, 15, 17 mm (L=63 mm); 1/4" (6.3 mm): 8, 9, 10, 12 mm (L=50 mm); CrV 50BV30: 1/2" (12.7 mm) x 15/16" (23.8 mm), 1/2" (12.7 mm) x 1" (25.4 mm), 1/2" (12.7 mm) x 1-1/16" (27.0 mm), 1/2" (12.7 mm) x 1-1/4" (31.8 mm), 3/8" (9.5 mm) x 3/8" (9.5 mm), 3/8" (9.5 mm) x 7/16" (11.1 mm), 3/8" (9.5 mm) x 1/2" (12.7 mm), 3/8" (9.5 mm) x 9/16" (14.3 mm), 3/8" (9.5 mm) x 5/8" (15.9 mm), 3/8" (9.5 mm) x 11/16" (17.5 mm), 3/8" (9.5 mm) x 3/4" (19.0 mm), 3/8" (9.5 mm) x 13/16" (20.6 mm), 3/8" (9.5 mm) x 7/8" (22.2 mm), 1/4" (6.3 mm) x 5/32" (4.0 mm), 1/4" (6.3 mm) x 3/16" (4.8 mm), 1/4" (6.3 mm) x 7/32" (5.6 mm), 1/4" (6.3 mm) x 1/4" (6.3 mm), 1/4" (6.3 mm) x 9/32" (7.1 mm), 1/4" (6.3 mm) x 5/16" (7.9 mm), 1/4" (6.3 mm) x 11/32" (8.7 mm), 1/4" (6.3 mm) x 3/8" (9.5 mm), 1/4" (6.3 mm) x 7/16" (11.1 mm), 1/4" (6.3 mm) x 1/2" (12.7 mm); CrV 50BV30: 1/2" (12.7 mm): 17, 19, 21, 23 mm; CrV 50BV30: 3/8" (9.5 mm): E8, E10, E11, E12, E14, E16, E18, E20; CrV 6150: 1/2" (12.7 mm): (127, 254 mm); 3/8" (9.5 mm): (76, 152.4 mm); 1/4" (6.3 mm): (50.8 mm); CrV 50BV30: 1/2" (12.7 mm), 3/8" (9.5 mm), 1/4" (6.3 mm); CrV 50BV30: 3/8" (9.5 mm): 16, 21 mm; CrV 50BV30: 1/2" (12.7 mm): (255 mm), 3/8" (9.5 mm): (200 mm), 1/4" (6.3 mm): (155 mm); 72T: CrMo 440: 1/4" (6.3 mm): (150 mm); CrV 50BV30: 1/4" (6.3 mm) x 1/4" (6.3 mm); CrV 50BV30: 1/4" (6.3 mm): T10, T15, T20, T25, T27, T30, T40 (L=25 mm); AISI S2: 3/8" (9.5 mm): 5.5, 6.5 mm (L=50 mm); AISI S2 / CrV 6150: 3/8" (9.5 mm): PH1, PH2 (L=50 mm); AISI S2 / CrV 6150: 3/8" (9.5 mm): PZ1, PZ2 (L=50 mm); AISI S2 / CrV 6150: 3/8" (9.5 mm): T20, T30, T40, T45, T50, T55, T60 (L=50 mm); AISI S2 / CrV 6150: 3/8" (9.5 mm): 3, 4, 5, 6 mm (L=50 mm); AISI S2 / CrV 6150: 8, 9, 10, 11, 12, 13, 14, 17, 18, 19 mm; CrV

| YATO | 1/2" (12.7 mm) | 3/8" (9.5 mm) | 1/4" (6.3 mm) | 2 |
|----------|----------------|---------------|---------------|---|
| YT-38801 | 1/2" (12.7 mm) | 3/8" (9.5 mm) | 1/4" (6.3 mm) | 2 |

GB Socket set
D Sechskant-Steckschlüssel-Satz
PL Komplet nasadek długich

RUS Набор насадок
CZ Sada nástrčných klíčů
H Dugókulcs készlet

RO Trusă chei tubulare
E Juego de herramientas
CN 套筒扳手组套

BMC & COLOR SLEEVE
XL SIZE



| | | | |
|-------------|---------------|-------------|-------|
| 128 PCS | 1/2" | 3/8" | 1/4" |
| | 12.5mm | 10mm | 6.3mm |
| CrV 6150 | CrV 50BV30 | CrMo 440 | |
| S2 | 72T | AS-DRIVE | |

2

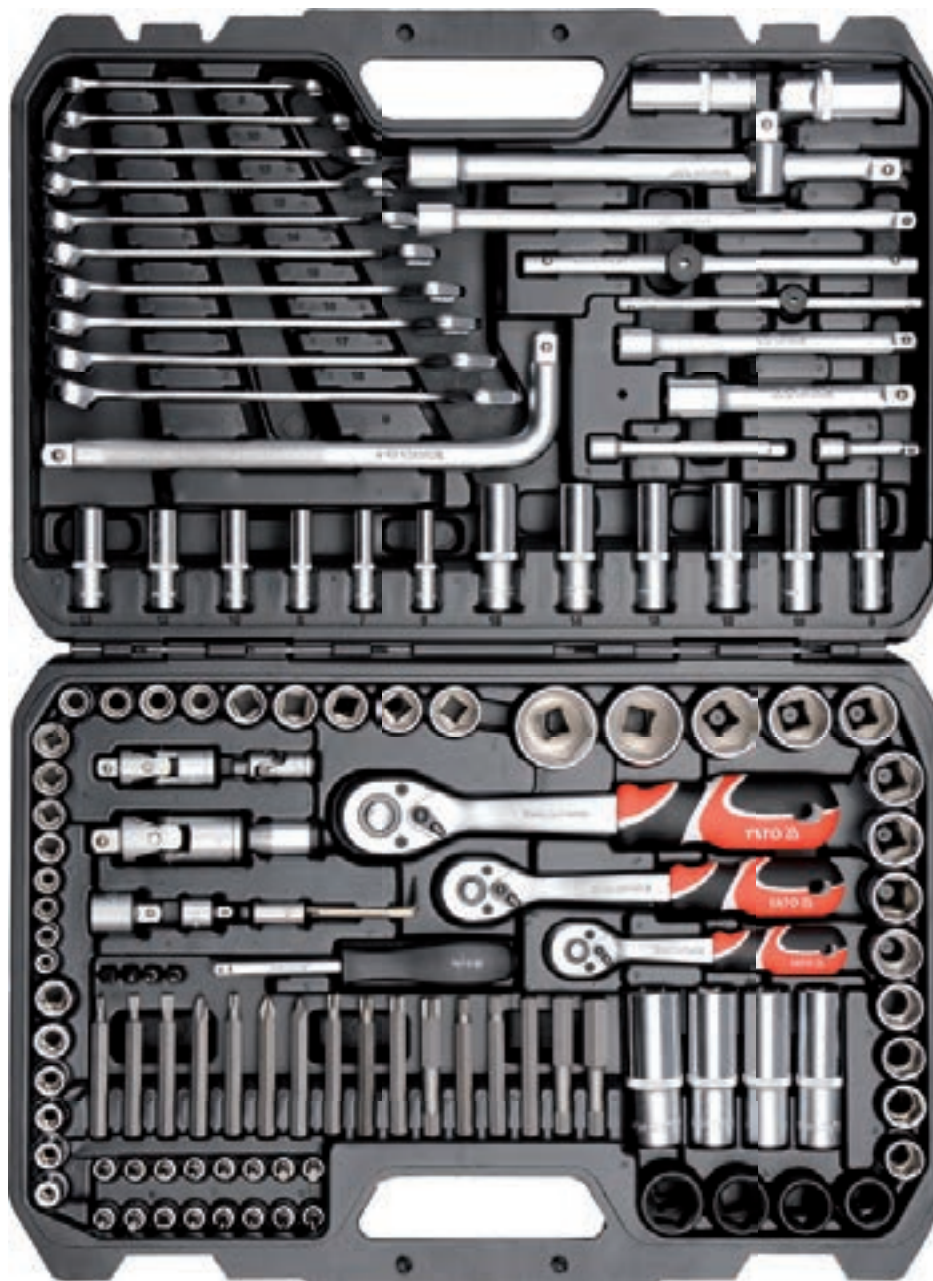

1/2" (12.7 mm): 14, 15, 16, 17, 18, 19, 20, 21, 22, 24 mm (L=38 mm); 27, 30, 32 mm (L=42 mm); 3/8" (9.5 mm): 10, 11, 12, 13, 14, 15, 16 mm (L=28 mm); 17, 18 mm (L=30 mm); 1/4" (6.3 mm): 6, 7, 8, 9, 10, 11, 12, 13 mm (L=25 mm); CrV 50BV30: 1/2" (12.7 mm): 17, 18, 19, 22 mm (L=76 mm); 3/8" (9.5 mm): 8, 10, 12, 13, 14, 15 mm (L=63 mm); 1/4" (6.3 mm): 6, 7, 8, 10, 12, 13 mm (L=50 mm); CrV 50BV30: 3/8" (9.5 mm): E8, E10, E11, E12, E14, E16; CrV 6150: 1/2" (12.7 mm): (127, 254 mm); 3/8" (9.5 mm): (152.4, 254 mm); 1/4" (6.3 mm): (50.8, 101.6 mm); CrV 50BV30: 3/8" (9.5 mm) (F) x 1/2" (12.7 mm) (M); CrV 50BV30: 1/2" (12.7 mm); 3/8" (9.5 mm); 1/4" (6.3 mm); CrV 50BV30: 1/2" (12.7 mm): 16, 21 mm; CrV 50BV30: 3/8" (9.5 mm): (198 mm); 1/4" (6.3 mm): (152.4 mm); CrV 50BV30: 1/2" (12.7 mm): (255 mm); 3/8" (9.5 mm): (200 mm); 1/4" (6.3 mm): (155 mm); 72T; CrMo 440: 1/4" (6.3 mm): (150 mm); CrV 50BV30: 1/2" (12.7 mm): (250 mm); CrV 50BV30: 3/8" (9.5 mm) x 5/16" (7.9 mm); CrV 50BV30: 1/2" (12.7 mm) x 3/8" (9.5 mm); 3/8" (9.5 mm) x 1/4" (6.3 mm); CrV 50BV30: 1/4" (6.3 mm) x 1/4" (6.3 mm); CrV 50BV30: 3/8" (9.5 mm): 5.5, 6.5 mm (L=70 mm); AISI S2: 3/8" (9.5 mm): PH1, PH2, PH3 (L=70 mm); AISI S2: 3/8" (9.5 mm): T20, T30, T40, T45, T50, T55 (L=70 mm); AISI S2: 3/8" (9.5 mm): 6, 7, 8, 10, 12 mm (L=70 mm); AISI S2: 1/4" (6.3 mm): PZ1, PZ2 (L=25 mm); AISI S2: 1/4" (6.3 mm): T8, T10 (L=25 mm); AISI S2: 1/4" (6.3 mm): 4.0, 5.5, 6.5 mm (L=37 mm); AISI S2 / CrV 6150: 1/4" (6.3 mm): PH1, PH2 (L=37 mm); AISI S2 / CrV 6150: 1/4" (6.3 mm): T8, T10, T15, T20, T25, T30, T40 (L=37 mm); AISI S2 / CrV 6150: 1/4" (6.3 mm): 3, 4, 5, 6 mm (L=37 mm); AISI S2 / CrV 6150: 8, 10, 12, 13, 14, 15, 16, 17, 18, 19 mm; CrV: 1.5, 2, 2.5 mm; CrV 6150

| | | | | |
|----------|----------------|---------------|---------------|---|
| YATO | ○ | ○ | ○ | ☐ |
| YT-38872 | 1/2" (12.7 mm) | 3/8" (9.5 mm) | 1/4" (6.3 mm) | 2 |



GB Socket set
D Sechskant-Steckschlüssel-Satz
PL Komplet nasadek dlugich

RUS Набор насадок
CZ Sada nástrčných klíčů
H Dugókulcs készlet

RO Trusă chei tubulare
E Juego de herramientas
CN 长套筒组套

8 PCS
1/4" 6.3mm
CrV 50BV30
AS-DRIVE



PLASTIC HANGER

1/4" (6.3 mm): 5.5, 6, 7, 8, 9, 10, 12, 13 mm
(L=50 mm); CrV 50BV30

| | | |
|-------------|---------------|----|
| YATO | 1/4" (6.3 mm) | 10 |
| YT-1443 | 1/4" (6.3 mm) | 10 |

GB Tool set
D Sechskant-Steckschlüssel-Satz
PL Zestaw narzędziowy
RUS Набор инструмента
CZ Sada nástrčných klíčů a ráčny

H Dugókulcs készlet racsnis hajtókarral
RO Rotrușă chei tubulare cu antrenor
E Juego de herramientas
CN 套筒扳手组套

METAL CASE & COLOR SLEEVE



1/4" 6.3mm
CrV 6140
72T
CrV 50BV30
AS-DRIVE



15 PCS

1/4" (6.3 mm): 4, 5, 6, 7, 8, 9, 10, 12, 13 mm (L=25 mm); CrV 50BV30;
1/4" (6.3 mm): (50.8, 152.4 mm); CrV 50BV30;
1/4" (6.3 mm); CrV 50BV30;
1/4" (6.3 mm): (127 mm); 72T; CrV 6140;
1/4" (6.3 mm): (150 mm); CrV 50BV30;

| | | |
|-------------|---------------|----|
| YATO | 1/4" (6.3 mm) | 10 |
| YT-1441 | 1/4" (6.3 mm) | 10 |



23 PCS

1/4" (6.3 mm): 4, 5, 6, 7, 8, 9, 10, 12, 13 mm (L=25 mm); CrV 50BV30;
1/4" (6.3 mm): 4, 5, 6, 7, 8, 9, 10, 12, 13 mm (L=50 mm); CrV 50BV30;
1/4" (6.3 mm): (50.8, 152.4 mm); CrV 50BV30;
1/4" (6.3 mm); CrV 50BV30;
1/4" (6.3 mm): (127 mm); 72T; CrV 6140;
1/4" (6.3 mm): (150 mm); CrV 50BV30

| | | |
|-------------|---------------|----|
| YATO | 1/4" (6.3 mm) | 10 |
| YT-1442 | 1/4" (6.3 mm) | 10 |

GB Tool set
 D Sechskant-Steckschlüssel-Satz
 PL Zestaw narzędziowy
 RUS Набор инструмента
 CZ Sada nástrčných kľúčů a ráčny

H Dugókulcs készlet racsnis hajtókarral
 RO Rotrusa chei tubulare cu antrenor
 E Juego de herramientas
 CN 套筒扳手组套

BMC & COLOR SLEEVE
 XS SIZE



| | | |
|---------------|---------------|----------|
| 1/4" 6.3mm | CrV 6140 | 72T |
| | CrV 50BV30 | AS-DRIVE |

2



15
PCS

1/4" (6.3 mm): 4, 5, 6, 7, 8, 9, 10, 12, 13 mm (L=25 mm); CrV 50BV30;
 1/4" (6.3 mm); (50.8, 152.4 mm); CrV 50BV30;
 1/4" (6.3 mm); CrV 50BV30;
 1/4" (6.3 mm); (155 mm); 72T; CrV 6140;
 1/4" (6.3 mm); (150 mm); CrV 50BV30

| YATO | | |
|---------|---------------|----|
| YT-1444 | 1/4" (6.3 mm) | 10 |



20
PCS

1/4" (6.3 mm): 3.5, 4, 4.5, 5, 5.5, 6, 7, 8, 9, 10, 11, 12, 13, 14 mm
 (L=25 mm); CrV 50BV30;
 1/4" (6.3 mm); (50.8, 152.4 mm); CrV 50BV30;
 1/4" (6.3 mm); CrV 50BV30;
 1/4" (6.3 mm); (152.4 mm); CrV 50BV30;
 1/4" (6.3 mm); (155 mm); 72T; CrV 6140;
 1/4" (6.3 mm); (150 mm); CrV 50BV30

| YATO | | |
|---------|---------------|----|
| YT-1449 | 1/4" (6.3 mm) | 10 |



23
PCS

1/4" (6.3 mm): 4, 5, 6, 7, 8, 9, 10, 12, 13 mm (L=25 mm); CrV 50BV30;
 1/4" (6.3 mm): 4, 5, 6, 7, 8, 9, 10, 12, 13 mm (L=50 mm); CrV 50BV30;
 1/4" (6.3 mm); (50.8, 152.4 mm); CrV 50BV30;
 1/4" (6.3 mm); CrV 50BV30;
 1/4" (6.3 mm); (155 mm); 72T; CrV 6140;

| YATO | | |
|---------|---------------|----|
| YT-1445 | 1/4" (6.3 mm) | 10 |

GB Tool set
D Sechskant-Steckschlüssel-Satz
PL Zestaw narzędziowy
RUS Набор инструмента
CZ Sada nástrčných klíčů a ráčny

H Dugókulcs készlet racsnis hajtókarral
RO Rotrușă chei tubulare cu antrenor
E Juego de herramientas
CN 套筒扳手组套

BMC & COLOR SLEEVE
XS SIZE



1/4"
6.3mm
CrV
6140
72T
CrV
50BV30
AS-DRIVE

2



25
PCS

1/4" (6.3 mm): 3.5, 4, 4.5, 5, 5.5, 6, 7, 8, 9, 10, 11, 12, 13, 14 mm (L=25 mm); CrV 50BV30;
1/4" (6.3 mm): 8, 10, 11, 12, 13 mm (L=50 mm); CrV 50BV30;
1/4" (6.3 mm): (50.8, 101.6 mm); CrV 50BV30;
1/4" (6.3 mm): CrV 50BV30;
1/4" (6.3 mm): (152.4 mm); CrV 50BV30;
1/4" (6.3 mm): (155 mm); 72T; CrV 6140;
1/4" (6.3 mm): (150 mm); CrV 50BV30

| YATO | | |
|---------|---------------|----|
| YT-1446 | 1/4" (6.3 mm) | 10 |



38
PCS

S2

CrV
6150

1/4" (6.3 mm): 3.5, 4, 4.5, 5, 5.5, 6, 7, 8, 9, 10, 11, 12, 13, 14 mm (L=25 mm); CrV 50BV30;
1/4" (6.3 mm): (50.8, 101.6 mm); CrV 50BV30;
1/4" (6.3 mm): (152.4 mm); CrV 50BV30;
1/4" (6.3 mm): (155 mm); 72T; CrV 6140;
1/4" (6.3 mm): (150 mm); CrV 50BV30;
1/4" (6.3 mm): PH1, PH2 (L=37 mm); AISI S2 / CrV 6150;
1/4" (6.3 mm): PZ1, PZ2 (L=37 mm); AISI S2 / CrV 6150;
1/4" (6.3 mm): T10, T15, T20, T25, T30, T40 (L=37 mm); AISI S2 / CrV 6150;
1/4" (6.3 mm): 3, 4, 5, 6, 8 mm (L=37 mm); AISI S2 / CrV 6150

| YATO | | |
|---------|---------------|----|
| YT-1447 | 1/4" (6.3 mm) | 10 |



42
PCS

CrV
6150

S2

1/4" (6.3 mm): 4, 4.5, 5, 5.5, 6, 7, 8, 9, 10, 11, 12, 13, 14 mm (L=25 mm); CrV 50BV30;
1/4" (6.3 mm): 8, 9, 10, 11, 12, 13 mm (L=50 mm); CrV 50BV30;
1/4" (6.3 mm): (50.8, 101.6 mm); CrV 50BV30;
1/4" (6.3 mm): (150 mm); CrV 6140;
1/4" (6.3 mm): (152.4 mm); CrV 50BV30;
1/4" (6.3 mm): (155 mm); 72T; CrV 6140;
1/4" (6.3 mm): (150 mm); CrV 50BV30;
1/4" (6.3 mm) x 1/4" (6.3 mm); CrV 6140;
1/4" (6.3 mm): 3, 4, 5 mm (L=25 mm); AISI S2;
1/4" (6.3 mm): PH0, PH1, PH2 (L=25 mm); AISI S2;
1/4" (6.3 mm): PZ0, PZ1, PZ2 (L=25 mm); AISI S2;
1/4" (6.3 mm): 6, 7, 8 mm (L=25 mm); AISI S2;
1.5, 2, 2.5 mm; CrV 6150

| YATO | | |
|---------|---------------|---|
| YT-1448 | 1/4" (6.3 mm) | 6 |

GB Tool set
 D Sechskant-Steckschlüssel-Satz
 PL Zestaw narzędziowy
 RUS Набор инструмента
 CZ Sada nástrčných klíčů a ráčny

H Dugókulcs készlet racsnis hajtókarral
 RO Rotrusa chei tubulare cu antrenor
 E Juego de herramientas
 CN 套筒扳手组套















BMC & COLOR SLEEVE
 XS SIZE



| | | |
|-----------|---------------|---------------|
| 56 PCS | 1/4" 6.3mm | CrV 6140 |
| | CrV 6150 | CrV 50BV30 |
| | S2 | 72T |
| | | AS-DRIVE |

2



 1/4" (6.3 mm): 4, 4.5, 5, 5.5, 6, 7, 8, 9, 10, 11, 12, 13 mm (L=25 mm); CrV 50BV30;
 1/4" (6.3 mm): 6, 7, 8, 9, 10, 11, 12, 13 mm (L=50 mm); CrV 50BV30;  1/4" (6.3 mm): E4, E5, E6, E7, E8, E10; CrV 50BV30;  1/4" (6.3 mm): (76, 152.4 mm); CrV 50BV30;  1/4" (6.3 mm): (150 mm); CrV 6140;  1/4" (6.3 mm); CrV 50BV30;  1/4" (6.3 mm): (152.4 mm); CrV 50BV30;
 1/4" (6.3 mm): (155 mm); 72T; CrV 6140;  1/4" (6.3 mm): (150 mm); CrV 50BV30;  1/4" (6.3 mm) (F) x 3/8" (9.5 mm) (M); CrV 50BV30;
 1/4" (6.3 mm): 4, 5, 5.5, 6.5 mm (L=37 mm); AISI S2 / CrV 6150;  1/4" (6.3 mm): PH1, PH2, PH3 (L=37 mm); AISI S2 / CrV 6150;  1/4" (6.3 mm): PZ1, PZ2, PZ3 (L=37 mm); AISI S2 / CrV 6150;  1/4" (6.3 mm): T8, T10, T15, T20, T25, T30, T40 (L=37 mm); AISI S2 / CrV 6150; 1/4" (6.3 mm): 3, 4, 5, 6, 7, 8 mm (L=37 mm); AISI S2 / CrV 6150

| | | |
|---|---|---|
| YATO  |  |  |
| YT-1450 | 1/4" (6.3 mm) | 10 |

GB Socket set
D Sechskant-Steckschlüssel-Satz
PL Komplet nasadek długich

RUS Набор насадок
CZ Sada nástrčných klíčů
H Dugókulcs készlet

RO Trusă chei tubulare
E Juego de herramientas
CN 套筒扳手组套

9
PCS

3/8"
10mm

CrV
50BV30

AS-DRIVE



PLASTIC HANGER

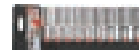

3/8" (9.5 mm): 8, 10, 11, 12, 13, 14,
16, 17, 19 mm (L=63 mm); CrV 50BV30

| | | |
|---|---|---|
| YATO  |  |  |
| YT-3855 | 3/8" (9.5 mm) | 10 |

GB Tool set
D Sechskant-Steckschlüssel-Satz
PL Zestaw narzędziowy

RUS Набор инструмента
CZ Sada nástrčných klíčů a ráčny
H Dugókulcs készlet racsnis hajtókarral

RO Rotrușa chei tubulare cu antrenor
E Juego de herramientas
CN 套筒扳手组套

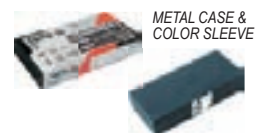

METAL CASE &
COLOR SLEEVE

3/8"
10mm

CrV
6140

CrV
50BV30

72T

AS-DRIVE



15
PCS

3/8" (9.5 mm): 10, 11, 12, 13, 14, 15 (L=28 mm); 17, 19, 21, 22 mm (L=30 mm); CrV 50BV30;
3/8" (9.5 mm): (76, 152.4 mm); CrV 50BV30;
3/8" (9.5 mm): 16, 21 mm; CrV 50BV30;
3/8" (9.5 mm): (200 mm); 72T; CrV 6140

| | | |
|---|---|---|
| YATO  |  |  |
| YT-38631 | 3/8" (9.5 mm) | 10 |

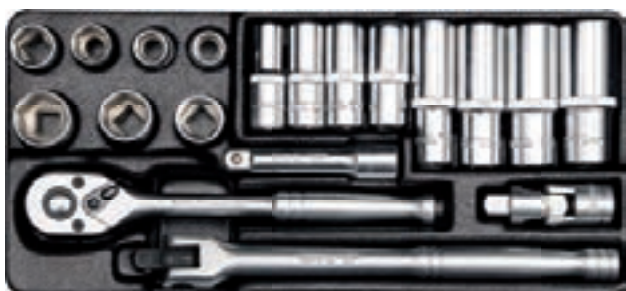

19
PCS

3/8" (9.5 mm): 10, 11, 13, 14, 15 (L=28 mm); 17, 19 mm (L=30 mm); CrV 50BV30;
3/8" (9.5 mm): 10, 11, 12, 13 mm (L=46 mm); 14, 15, 17, 19 mm (L=63 mm); CrV 50BV30;
3/8" (9.5 mm): (76 mm); CrV 50BV30; 3/8" (9.5 mm); CrV 50BV30;
3/8" (9.5 mm): (200 mm); 72T; CrV 6140;
3/8" (9.5 mm): (215 mm); CrV 50BV30

| | | |
|---|---|---|
| YATO  |  |  |
| YT-38641 | 3/8" (9.5 mm) | 8 |

GB Tool set
D Sechskant-Steckschlüssel-Satz
PL Zestaw narzędziowy
RUS Набор инструмента
CZ Sada nástrčných klíčů a ráčny

H Dugókulcs készlet racsnis hajtókarral
RO Rotrușa chei tubulare cu antrenor
E Juego de herramientas
CN 套筒扳手组套

BMC & COLOR SLEEVE
XS SIZE



22
PCS

3/8"
10mm

CrV
6140

CrV
50BV30

72T

AS-DRIVE



3/8" (9.5 mm): 6, 7, 8, 9, 10, 11, 12, 13, 14, 15, 16 mm (L=28 mm); 17, 18, 19,
20, 21, 22 mm (L=30 mm); CrV 50BV30;
3/8" (9.5 mm): (76, 152.4 mm); CrV 50BV30;
3/8" (9.5 mm); CrV 50BV30;
3/8" (9.5 mm): (198 mm); CrV 50BV30;
3/8" (9.5 mm): (200 mm); 72T; CrV 6140

| | | |
|---|---|---|
| YATO  |  |  |
| YT-3856 | 3/8" (9.5 mm) | 10 |

GB Tool set
 D Sechskant-Steckschlüssel-Satz
 PL Zestaw narzędziowy
 RUS Набор инструмента
 CZ Sada nástrčných klíčů a ráčny

H Dugókulcs készlet racsnis hajtókarral
 RO Rotrusa chei tubulare cu antrenor
 E Juego de herramientas
 CN 套筒扳手组套

BMC & COLOR SLEEVE
 M SIZE

| | | |
|-----------|---------------|---------------|
| 58 PCS | 3/8" 10 mm | CrV 6140 |
| | CrV 6150 | CrV 50BV30 |
| | S2 | 72T |
| | | AS-DRIVE |



2



3/8" (9.5 mm): 6, 7, 8, 9, 10, 11, 12, 13, 14, 15, 16 mm (L=28 mm); 17, 18, 19, 20, 21, 22, 24 mm (L=30 mm); CrV 50BV30: 3/8" (9.5 mm): 8, 10, 11, 12, 13, 14, 15, 17, 19 mm (L=63 mm); CrV 50BV30: 3/8" (9.5 mm): (76, 254 mm); CrV 50BV30: 3/8" (9.5 mm); CrV 50BV30: 3/8" (9.5 mm): (12.7 mm) (F) x 3/8" (9.5 mm) (M); CrV 50BV30: 3/8" (9.5 mm): 5.5, 6.5, 8 mm (L=50 mm); AISI S2 / CrV 6150: 3/8" (9.5 mm): PH1, PH2, PH3 (L=50 mm); AISI S2 / CrV 6150: 3/8" (9.5 mm): PZ1, PZ2 (L=50 mm); AISI S2 / CrV 6150: 3/8" (9.5 mm): T10, T15, T20, T25, T30, T40, T45, T50, T55 (L=50 mm); AISI S2 / CrV 6150: 3/8" (9.5 mm): 3, 4, 5, 6, 7, 8, 10 mm (L=50 mm); AISI S2 / CrV 6150

| | | |
|-------------|---------------|---|
| YATO | 3/8" (9.5 mm) | 6 |
| YT-3857 | | |

GB Socket set
D Sechskant-Steckschlüssel-Satz
PL Komplet nasadek długich

RUS Набор насадок
CZ Sada nástrčných klíčů
H Dugókulcs készlet

RO Trusă chei tubulare
E Juego de herramientas
CN 套筒扳手组套

10 PCS
1/2" 12.5mm
CrV 50BV30
AS-DRIVE



1/2" (12.7 mm): 10, 12, 13, 14, 15, 17, 19, 21, 22, 24 mm (L=76 mm); CrV 50BV30

PLASTIC HANGER



| | | |
|-------------|----------------|----|
| YATO | ○ | |
| YT-3886 | 1/2" (12.7 mm) | 10 |

GB Socket set
D Sechskantenschlüssel-Einsatz
PL Komplet nasadek z akcesoriami

RUS Набор торцевых головок
CZ Sada nástrčných klíčů a ráčny
H Dugókulcs készlet racsnis hajtókarral

RO Trusă chei tubulare cu antrenor
E Juego de boquillas con accesorios
CN 套筒扳手组套

PLASTIC HANGER



12 PCS
1/2" 12.5mm
CrV 6140

CrV 50BV30
72T
AS-DRIVE



1/2" (12.7 mm): 10, 11, 12, 13, 14, 15, 17, 19, 21, 24 mm (L=38 mm); CrV 50BV30;
1/2" (12.7 mm); (127 mm); CrV 50BV30;
1/2" (12.7 mm); (255 mm); 72T; CrV 6140

| | | |
|-------------|----------------|----|
| YATO | ○ | |
| YT-3882 | 1/2" (12.7 mm) | 10 |

GB Ratchet handle with socket set
D Sechskant-Steckschlüssel-Satz
PL Komplet nasadek z grzechotką

RUS Набор насадок
CZ Sada nástrčných klíčů a ráčny
H Dugókulcs készlet racsnis hajtókarral

RO Rotrușă chei tubulare cu antrenor
E Matraca con boquillas
CN 套筒扳手组套

PLASTIC HANGER



19 PCS
1/2" 12.5mm
CrV 6140

CrV 50BV30
72T
AS-DRIVE



1/2" (12.7 mm): 8, 9, 10, 11, 12, 13, 14, 15, 16, 17, 19, 21, 22, 23, 24 mm (L=38 mm);
27, 30, 32 mm (L=42 mm); CrV 50BV30;
1/2" (12.7 mm); (255 mm); 72T; CrV 6140

| | | |
|-------------|----------------|---|
| YATO | ○ | |
| YT-3868 | 1/2" (12.7 mm) | 6 |

GB Tool set
D Sechskant-Steckschlüssel-Satz
PL Zestaw narzędziowy

RUS Набор инструмента
CZ Sada nástrčných klíčů a ráčny
H Dugókulcs készlet racsnis hajtókarral

RO Rotrușă chei tubulare cu antrenor
E Juego de herramientas
CN 套筒扳手组套



METAL CASE & COLOR SLEEVE

1/2" 12.5mm
CrV 6140
CrV 50BV30

72T
AS-DRIVE



12 PCS

1/2" (12.7 mm): 10, 11, 12, 13, 14, 15, 17, 19, 21, 24 mm (L=38 mm); CrV 50BV30;
1/2" (12.7 mm); (125 mm); CrV 50BV30;
1/2" (12.7 mm); (250 mm); 72T; CrV 6140

| | | |
|-------------|----------------|---|
| YATO | ○ | |
| YT-12621 | 1/2" (12.7 mm) | 8 |



18 PCS

1/2" (12.7 mm): 11, 13, 14, 15, 17, 19, 21, 22, 23, 24 mm (L=38 mm);
27, 30, 32 mm (L=42 mm); CrV 50BV30;
1/2" (12.7 mm); (125 mm); CrV 50BV30;
1/2" (12.7 mm); 16, 21 mm; CrV 50BV30;
1/2" (12.7 mm); (250 mm); 72T; CrV 6140;
1/2" (12.7 mm); (460 mm); CrV 50BV30

| | | |
|-------------|----------------|---|
| YATO | ○ | |
| YT-12641 | 1/2" (12.7 mm) | 5 |

GB Tool set
D Sechskant-Steckschlüssel-Satz
PL Zestaw narzędziowy

RUS Набор инструмента
CZ Sada nástrčných klíčů a ráčny
H Dugókulcs készlet racsnis hajtókarral

RO Rotrusa chei tubulare cu antrenor
E Juego de herramientas
CN 套筒扳手组套



METAL CASE & COLOR SLEEVE
1/2" 12.5mm CrV 6140 CrV 50BV30
72T AS-DRIVE

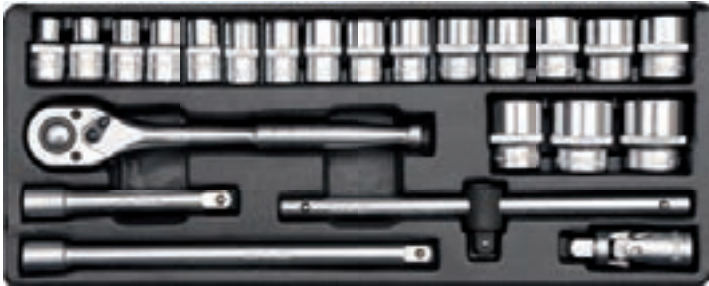

23 PCS

- 1/2" (12.7 mm): 10, 11, 12, 13, 14, 15, 16, 17, 18, 19, 20, 21, 22, 23, 24 mm (L=38 mm); 27, 30, 32 mm (L=42 mm); CrV 50BV30;
- 1/2" (12.7 mm): (125, 250 mm); CrV 50BV30;
- 1/2" (12.7 mm): CrV 50BV30;
- 1/2" (12.7 mm): (250 mm); CrV 50BV30;
- 1/2" (12.7 mm): (250 mm); 72T; CrV 6140

| | | |
|-------------|----------------|---|
| YATO | ○ | |
| YT-12651 | 1/2" (12.7 mm) | 5 |



24 PCS

- 1/2" (12.7 mm): 10, 11, 12, 13, 14, 15, 16, 17, 18, 19, 20, 21, 22, 23, 24 mm (L=38 mm); 27, 30, 32 mm (L=42 mm); CrV 50BV30;
- 1/2" (12.7 mm): (125 mm); CrV 50BV30; 1/2" (12.7 mm): CrV 50BV30;
- 1/2" (12.7 mm): 16, 21 mm; CrV 50BV30;
- 1/2" (12.7 mm): (250 mm); CrV 50BV30;
- 1/2" (12.7 mm): (250 mm); 72T; CrV 6140

| | | |
|-------------|----------------|---|
| YATO | ○ | |
| YT-12661 | 1/2" (12.7 mm) | 5 |



25 PCS

- 1/2" (12.7 mm): 10, 11, 12, 13, 14, 15, 16, 17, 18, 19, 20, 21, 22, 23, 24 mm (L=38 mm); 27, 30, 32 mm (L=42 mm); CrV 50BV30;
- 1/2" (12.7 mm): (50, 125 mm); CrV 50BV30;
- 1/2" (12.7 mm): 16, 21 mm; CrV 50BV30;
- 1/2" (12.7 mm): (250 mm); CrV 50BV30;
- 1/2" (12.7 mm): (250 mm); 72T; CrV 6140;
- 1/2" (12.7 mm): (317 mm); CrV 50BV30

| | | |
|-------------|----------------|---|
| YATO | ○ | |
| YT-12671 | 1/2" (12.7 mm) | 5 |

GB Tool set
D Sechskant-Steckschlüssel-Satz
PL Zestaw narzędziowy

RUS Набор инструмента
CZ Sada nástrčných klíčů a ráčny
H Dugókulcs készlet racsnis hajtókarral

RO Rotrusa chei tubulare cu antrenor
E Juego de herramientas
CN 套筒扳手组套

1/2" 12.5mm CrV 6140 CrV 50BV30
72T AS-DRIVE



12 PCS

- 1/2" (12.7 mm): 10, 11, 12, 13, 14, 15, 17, 19, 21, 24 mm (L=38 mm); CrV 50BV30;
- 1/2" (12.7 mm): (127 mm); CrV 50BV30;
- 1/2" (12.7 mm): (255 mm); 72T; CrV 6140



| | | |
|-------------|----------------|----|
| YATO | ○ | |
| YT-3867 | 1/2" (12.7 mm) | 10 |



18 PCS

- 1/2" (12.7 mm): 11, 13, 14, 15, 17, 19, 21, 22, 23, 24 mm (L=38 mm); 27, 30, 32 mm (L=42 mm); CrV 50BV30;
- 1/2" (12.7 mm): (127 mm); CrV 50BV30;
- 1/2" (12.7 mm): 16, 21 mm; CrV 50BV30;
- 1/2" (12.7 mm): (255 mm); 72T; CrV 6140;
- 1/2" (12.7 mm): (457 mm); CrV 50BV30



| | | |
|-------------|----------------|---|
| YATO | ○ | |
| YT-3870 | 1/2" (12.7 mm) | 6 |

GB Tool set
D Sechskant-Steckschlüssel-Satz
PL Zestaw narzędziowy
RUS Набор инструмента
CZ Sada nástrčných klíčů a ráčny

H Dugókulcs készlet racsnis hajtókarral
RO Rotrusa chei tubulare cu antrenor
E Juego de herramientas
CN 套筒扳手套

BMC & COLOR SLEEVE
M SIZE



1/2"
12.5mm

CrV
6140

CrV
50BV30







72T

AS-DRIVE

2







20
PCS



-  1/2" (12.7 mm): 10, 11, 12, 13, 14, 15, 16, 17, 18, 19, 22, 24 mm (L=38 mm); CrV 50BV30;
-  1/2" (12.7 mm): 13, 17, 19 mm (L=76 mm); CrV 50BV30;
-  1/2" (12.7 mm); (254 mm); CrV 50BV30;
-  3/8" (9.5 mm) (F) x 1/2" (12.7 mm) (M); CrV 50BV30;
-  1/2" (12.7 mm); CrV 50BV30;
-  1/2" (12.7 mm): 16 mm; CrV 50BV30;
-  1/2" (12.7 mm): (255 mm); 72T; CrV 6140

| YATO  |  |  |
|--|---|---|
| YT-3869 | 1/2" (12.7 mm) | 6 |









23
PCS



-  1/2" (12.7 mm): 10, 11, 12, 13, 14, 15, 16, 17, 18, 19, 20, 21, 22, 23, 24 mm (L=38 mm); 27, 30, 32 mm (L=42 mm); CrV 50BV30;
-  1/2" (12.7 mm); (127, 254 mm); CrV 50BV30;
-  1/2" (12.7 mm); CrV 50BV30;
-  1/2" (12.7 mm); (255 mm); CrV 50BV30;
-  1/2" (12.7 mm); (255 mm); 72T; CrV 6140

| YATO  |  |  |
|--|---|---|
| YT-3873 | 1/2" (12.7 mm) | 6 |



24
PCS

-  1/2" (12.7 mm): 10, 11, 12, 13, 14, 15, 16, 17, 18, 19, 20, 21, 22, 23, 24 mm (L=38 mm); 27, 30, 32 mm (L=42 mm); CrV 50BV30;
-  1/2" (12.7 mm); (127 mm); CrV 50BV30;
-  1/2" (12.7 mm); CrV 50BV30;
-  1/2" (12.7 mm): 16, 21 mm; CrV 50BV30;
-  1/2" (12.7 mm); (255 mm); CrV 50BV30;
-  1/2" (12.7 mm); (255 mm); 72T; CrV 6140

| YATO  |  |  |
|--|---|---|
| YT-3872 | 1/2" (12.7 mm) | 6 |

GB Tool set
 D Sechskant-Steckschlüssel-Satz
 PL Zestaw narzędziowy

RUS Набор инструмента
 CZ Sada nástrčných klíčů a ráčny
 H Dugókulcs készlet racsnis hajtókarral

RO Rotrușă de tubulare cu antrenor
 E Juego de herramientas
 CN 套筒扳手组套

1/2"
12.5mm
CrV
6140
CrV
50BV30
72T
AS-DRIVE

2



25
PCS

- 1/2" (12.7 mm): 8, 9, 10, 11, 12, 13, 14, 15, 16, 17, 18, 19, 20, 21, 22, 23, 24 mm (L=38 mm); 27, 30, 32 mm (L=42 mm); CrV 50BV30;
- 1/2" (12.7 mm): (127, 254 mm); CrV 50BV30;
- 3/8" (9.5 mm) (F) x 1/2" (12.7 mm) (M); CrV 50BV30;
- 1/2" (12.7 mm); CrV 50BV30;
- 1/2" (12.7 mm): (255 mm); 72T; CrV 6140

BMC & COLOR SLEEVE
M SIZE



| | | |
|-------------|----------------|---|
| YATO | ○ | |
| YT-3871 | 1/2" (12.7 mm) | 6 |

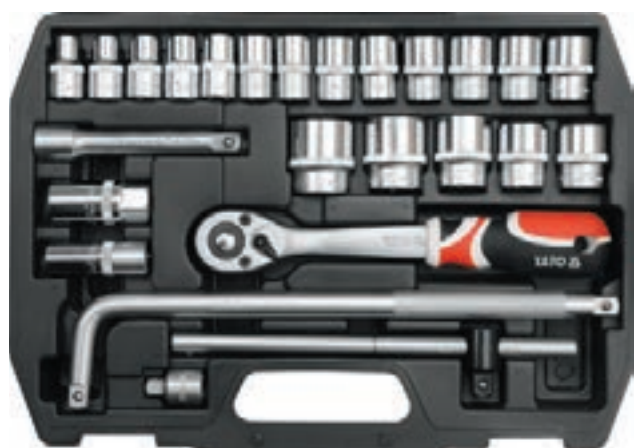

25
PCS

- 1/2" (12.7 mm): 10, 11, 12, 13, 14, 15, 16, 17, 18, 19, 20, 21, 22, 23, 24 mm (L=38 mm); 27, 30, 32 mm (L=42 mm); CrV 50BV30;
- 1/2" (12.7 mm): (127 mm); CrV 50BV30;
- 1/2" (12.7 mm): 16, 21 mm; CrV 50BV30;
- 1/2" (12.7 mm): (255 mm); CrV 50BV30;
- 1/2" (12.7 mm): (255 mm); 72T; CrV 6140;
- 1/2" (12.7 mm): (317 mm); CrV 50BV30;
- 1/2" (12.7 mm) (F) x 3/8" (9.5 mm) (M); CrV 50BV30

BMC & COLOR SLEEVE
L SIZE



| | | |
|-------------|----------------|---|
| YATO | ○ | |
| YT-3874 | 1/2" (12.7 mm) | 6 |



38
PCS

- 1/2" (12.7 mm): 10, 11, 12, 13, 14, 15, 16, 17, 18, 19, 20, 21, 22, 23, 24 mm (L=38 mm); 27, 30, 32 mm (L=42 mm); CrV 50BV30;
- 1/2" (12.7 mm): 10, 13, 17, 19 mm (L=76 mm); CrV 50BV30;
- 1/2" (12.7 mm): (127, 254 mm); CrV 50BV30;
- 1/2" (12.7 mm); CrV 50BV30;
- 1/2" (12.7 mm): 16, 21 mm; CrV 50BV30;
- 1/2" (12.7 mm): (255 mm); CrV 50BV30;
- 1/2" (12.7 mm): (255 mm); 72T; CrV 6140;
- 8, 10, 11, 12, 13, 14, 17, 19, 22 mm; CrV

BMC & COLOR SLEEVE
M SIZE



| | | |
|-------------|----------------|---|
| YATO | ○ | |
| YT-3876 | 1/2" (12.7 mm) | 6 |

GB Tool set
D Sechskant-Steckschlüssel-Satz
PL Zestaw narzędziowy

RUS Набор инструмента
CZ Sada nástrčných klíčů a ráčny
H Dugókulcs készlet racsnis hajtókarral

RO Rotrușa chei tubulare cu antrenor
E Juego de herramientas
CN 套筒扳手组套

BMC & COLOR SLEEVE
M SIZE



| | |
|--------------------|----------------|
| 46 PCS | 1/2" 12.5mm |
| CrV 6140 | CrV 50BV30 |
| 72T | AS-DRIVE |
| METRIC & S.A.E. | |



1/2" (12.7 mm): 8, 9, 10, 11, 12, 13, 14, 15, 16, 17, 18, 19, 20, 21, 22, 23, 24 mm (L=38 mm); 27, 30, 32 mm (L=42 mm); CrV 50BV30: 1/2" (12.7 mm): 10, 12, 13, 14, 15, 17, 19 mm (L=76 mm); CrV 50BV30: 1/2" (12.7 mm) x 3/8" (9.5 mm), 1/2" (12.7 mm) x 7/16" (11.1 mm), 1/2" (12.7 mm) x 1/2" (12.7 mm), 1/2" (12.7 mm) x 9/16" (14.3 mm), 1/2" (12.7 mm) x 5/8" (15.9 mm), 1/2" (12.7 mm) x 11/16" (17.5 mm), 1/2" (12.7 mm) x 3/4" (19.0 mm), 1/2" (12.7 mm) x 13/16" (20.6 mm), 1/2" (12.7 mm) x 7/8" (22.2 mm), 1/2" (12.7 mm) x 15/16" (23.8 mm), 1/2" (12.7 mm) x 1" (25.4 mm); CrV 50BV30: 1/2" (12.7 mm): (127, 254 mm); CrV 50BV30: 3/8" (9.5 mm) (F) x 1/2" (12.7 mm) (M); CrV 50BV30: 1/2" (12.7 mm); CrV 50BV30: 1/2" (12.7 mm): 16, 21 mm; CrV 50BV30: 1/2" (12.7 mm): (255 mm); 72T: CrV 6140: 1/2" (12.7 mm); (250 mm); CrV 50BV30

| | | |
|---------|----------------|---|
| YATO | 1/2" (12.7 mm) | 6 |
| YT-3877 | | |

GB Tool set
D Sechskant-Steckschlüssel-Satz
PL Zestaw narzędziowy

RUS Набор инструмента
CZ Sada nástrčných klíčů a ráčny
H Dugókulcs készlet racsnis hajtókarral

RO Rotrușa chei tubulare cu antrenor
E Juego de herramientas
CN 套筒扳手组套

BMC & COLOR SLEEVE
M SIZE



| | | |
|-------------|----------------|---------------|
| 72 PCS | 1/2" 12.5mm | 1/4" 6.3mm |
| CrV 6140 | CrV 50BV30 | |
| 72T | AS-DRIVE | |



1/2" (12.7 mm): 10, 11, 12, 13, 14, 15, 16, 17, 18, 19, 20, 21, 22, 23, 24 mm (L=38 mm); 27 mm (L=42 mm), 1/4" (6.3 mm): 4, 5, 6, 7, 8, 9, 10, 11, 12, 13 mm (L=25 mm); CrV 50BV30: 1/2" (12.7 mm): (127, 254 mm); 1/4" (6.3 mm): (152.4 mm); CrV 50BV30: 3/8" (9.5 mm) (F) x 1/2" (12.7 mm) (M); CrV 50BV30: 1/2" (12.7 mm); CrV 50BV30: 1/2" (12.7 mm): 21 mm; CrV 50BV30: 1/2" (12.7 mm): (255 mm), 1/4" (6.3 mm): (155 mm); 72T: CrV 6140: 1/4" (6.3 mm); (150 mm); CrV 50BV30: 1/4" (6.3 mm) x 1/4" (6.3 mm); CrV 6140: 1/4" (6.3 mm): 4, 5, 5.5, 6, 7 mm (L=25 mm); CrV 6150: 1/4" (6.3 mm): PH0, PH1, PH2, PH3 (L=25 mm); CrV 6150: 1/4" (6.3 mm): PZ0, PZ1, PZ2, PZ3 (L=25 mm); CrV 6150: 1/4" (6.3 mm): T8, T9, T10, T15, T20, T25, T27, T30, T40 (L=25 mm); CrV 6150: 1/4" (6.3 mm): 3, 4, 5, 6, 7, 8 mm (L=25 mm); CrV 6150: 1/4" (6.3 mm): S0, S1, S2, S3 (L=25 mm); CrV 6150: 1.25, 1.5, 2.5, 3 mm; CrV 6150

| | | | |
|----------|----------------|---------------|---|
| YATO | 1/2" (12.7 mm) | 1/4" (6.3 mm) | 4 |
| YT-38782 | | | |

GB Tool set
 D Sechskant-Steckschlüssel-Satz
 PL Zestaw narzędziowy

RUS Набор инструмента
 CZ Sada nástrčných klíčů a ráčny
 H Dugókulcs készlet racsnis hajtókarral

RO Rotruşa chei tubulare cu antrenor
 E Juego de herramientas
 CN 套筒扳手组套

1/2" 12.5mm
 1/4" 6.3mm
 CrV 6140 CrV 50BV30
 S2 72T
 AS-DRIVE

2



BMC & COLOR SLEEVE L SIZE



77 PCS CrV 6150

1/2" (12.7 mm): 10, 11, 12, 13, 14, 15, 17, 19, 22, 24 mm (L=38 mm); 27, 30, 32 mm (L=42 mm); 1/4" (6.3 mm): 4, 5, 6, 7, 8, 9, 10, 11, 12 mm (L=25 mm); CrV 50BV30; 1/2" (12.7 mm): (127, 254 mm); 1/4" (6.3 mm): (76, 101.6 mm); CrV 50BV30; 1/2" (12.7 mm); 1/4" (6.3 mm); CrV 50BV30; 1/2" (12.7 mm): 16, 21 mm; CrV 50BV30; 1/2" (12.7 mm): (255 mm); 1/4" (6.3 mm): (155 mm); 72T; CrV 6140; 1/4" (6.3 mm) x 1/4" (6.3 mm); CrV 6140; 1/4" (6.3 mm) x 1/4" (6.3 mm) (L=25 mm); CrV 6140; 1/4" (6.3 mm): 3, 4, 5, 5, 7 mm (L=25 mm); AISI S2; 1/4" (6.3 mm): PH0, PH1, PH2, PH3 (L=25 mm); AISI S2; 1/4" (6.3 mm): PZ1, PZ2, PZ3 (L=25 mm); AISI S2; 1/4" (6.3 mm): T10, T15, T20, T25, T30 (L=25 mm); AISI S2; 1/4" (6.3 mm): 2, 3, 4, 5, 6 mm (L=25 mm); AISI S2; 7, 8, 9, 10, 11, 12, 13, 14, 15, 17, 19 mm; CrV; 8x9, 10x11, 12x13, 14x15 mm; CrV 6140; 1.5, 2, 2.5, 5, 6, 8, 10 mm; CrV 6150

| YATO | 1/2" (12.7 mm) | 1/4" (6.3 mm) | 2 |
|---------|----------------|---------------|---|
| YT-3878 | | | |



BMC & COLOR SLEEVE XXXL SIZE



79 PCS CrV 55 CrV 60
 CrMo SK5 SVCM 55

1/2" (12.7 mm): 10, 11, 12, 13, 14, 16, 17, 19, 22, 24, 26 mm (L=38 mm); 27, 30, 32 mm (L=42 mm); 1/4" (6.3 mm): 5, 6, 7, 8, 9, 10, 11, 12, 13 mm (L=25 mm); CrV 50BV30; 1/2" (12.7 mm): 10, 11, 12, 13, 14, 17, 19 mm (L=76 mm); CrV 50BV30; 1/2" (12.7 mm); 1/4" (6.3 mm): (50.8 mm); CrV 50BV30; 1/2" (12.7 mm); CrV 50BV30; 1/2" (12.7 mm): 16, 21 mm; CrV 50BV30; 1/2" (12.7 mm): (255 mm); 1/4" (6.3 mm): (155 mm); 72T; CrV 6140; 1/4" (6.3 mm); (150 mm); CrV 50BV30; 1/2" (12.7 mm): (420 mm); CrV 50BV30; 6, 7, 8, 9, 10, 11, 12, 13, 14, 16, 17, 19, 22, 24 mm; CrV; 2.0x40, 2.4x75 mm; S2; 3.0x75, 4.0x100, 6.5x150, 8.0x150 mm; SVCM55; PH0x75 mm; S2; PH1x75, PH2x100 mm; SVCM5 5; 180 mm; CrV 55; 160 mm; CrV 55; 160, 200 mm; CrV 55; 250 mm; CrV; 300 g; 300 mm; 180 mm; CrMo; 120 mm; CrV 60; SK5; 2.5, 3, 4, 5, 6, 8, 10 mm; CrV

| YATO | 1/2" (12.7 mm) | 1/4" (6.3 mm) | 2 |
|---------|----------------|---------------|---|
| YT-3891 | | | |

GB Tool set
 D Sechskant-Steckschlüssel-Satz
 PL Zestaw narzędziowy

RUS Набор инструмента
 CZ Sada nástrčných klíčů a ráčny
 H Dugókulcs készlet racsnis hajtókarral

RO Rotruşa chei tubulare cu antrenor
 E Juego de herramientas
 CN 套筒扳手组套

BMC & COLOR SLEEVE
 L SIZE



| | |
|---------------|-------------|
| 1/2" | 1/4" |
| 12.5mm | 6.3mm |
| CrV 6140 | CrV 6150 |
| CrV 50BV30 | S2 |
| 72T | AS-DRIVE |

2



82
 PCS

1/2" (12.7 mm): 14, 15, 16, 17, 18, 19, 20, 22, 24 mm (L=38 mm); 27, 30, 32 mm (L=42 mm); 1/4" (6.3 mm): 4, 4.5, 5, 5.5, 6, 7, 8, 9, 10, 11, 12, 13, 14 mm (L=25 mm); CrV 50BV30; 1/2" (12.7 mm): (127, 254 mm); 1/4" (6.3 mm): (50.8, 101.6 mm); CrV 50BV30; 3/8" (9.5 mm) (F) x 1/2" (12.7 mm) (M); CrV 50BV30; 1/4" (6.3 mm): (150 mm); CrV 6140; 1/2" (12.7 mm); 1/4" (6.3 mm); CrV 50BV30; 1/2" (12.7 mm): 16, 21 mm; CrV 50BV30; 1/4" (6.3 mm): (152.4 mm); CrV 50BV30; 1/2" (12.7 mm): (255 mm); 1/4" (6.3 mm): (155 mm); 72T; CrV 6140; 1/4" (6.3 mm): (150 mm); CrV 50BV30; 1/2" (12.7 mm) x 5/16" (7.9 mm); CrV 6140; 1/4" (6.3 mm) x 1/4" (6.3 mm); CrV 6140; 5/16" (7.9 mm): 8, 10, 12 mm (L=30 mm); AISI S2; 5/16" (7.9 mm): PH3, PH4 (L=30 mm); AISI S2; 5/16" (7.9 mm): PZ3, PZ4 (L=30 mm); AISI S2; 5/16" (7.9 mm): T40, T45, T50, T55 (L=30 mm); AISI S2; 5/16" (7.9 mm): 8, 10, 12, 14 mm (L=30 mm); AISI S2; 1/4" (6.3 mm): 4, 5.5, 7 mm (L=37 mm); AISI S2 / CrV 6150; 1/4" (6.3 mm): PH1, PH2 (L=37 mm); AISI S2 / CrV 6150; 1/4" (6.3 mm): PZ1, PZ2 (L=37 mm); AISI S2 / CrV 6150; 1/4" (6.3 mm): T8, T10, T15, T20, T25, T30 (L=37 mm); AISI S2 / CrV 6150; 1/4" (6.3 mm): 3, 4, 5, 6 mm (L=37 mm); AISI S2 / CrV 6150; 1/4" (6.3 mm): 8, 10, 11, 12, 13, 14, 17, 19, 22 mm; CrV

| YATO | 1/2" (12.7 mm) | 1/4" (6.3 mm) | 4 |
|---------|----------------|---------------|---|
| YT-1269 | | | |



94
 PCS

1/2" (12.7 mm): 10, 11, 12, 13, 14, 15, 16, 17, 18, 19, 20, 21, 22, 23, 24 mm (L=38 mm); 27, 30, 32 mm (L=42 mm); CrV 50BV30; 1/4" (6.3 mm): 4, 4.5, 5, 5.5, 6, 7, 8, 9, 10, 11, 12, 13, 14 mm (L=25 mm); CrV 50BV30; 1/2" (12.7 mm): 14, 15, 17, 19 mm (L=76 mm); 1/4" (6.3 mm): 6, 7, 8, 9, 10, 11, 12, 13 mm (L=50 mm); CrV 50BV30; 1/2" (12.7 mm): (127, 254 mm); 1/4" (6.3 mm): (50.8, 101.6 mm); CrV 50BV30; 3/8" (9.5 mm) (F) x 1/2" (12.7 mm) (M); CrV 50BV30; 1/4" (6.3 mm): (150 mm); CrV 6140; 1/2" (12.7 mm); 1/4" (6.3 mm); CrV 50BV30; 1/2" (12.7 mm): 16, 21 mm; CrV 50BV30; 1/4" (6.3 mm): (152.4 mm); CrV 50BV30; 1/2" (12.7 mm): (255 mm); 1/4" (6.3 mm): (155 mm); 72T; CrV 6140; 1/4" (6.3 mm): (150 mm); CrV 50BV30; 1/2" (12.7 mm) x 5/16" (7.9 mm); CrV 6140; 1/4" (6.3 mm) x 1/4" (6.3 mm) (L=25 mm); CrV 6140; 5/16" (7.9 mm): 8, 10, 12 mm (L=30 mm); AISI S2; 5/16" (7.9 mm): PH3, PH4 (L=30 mm); AISI S2; 5/16" (7.9 mm): PZ3, PZ4 (L=30 mm); AISI S2; 5/16" (7.9 mm): T40, T45, T50, T55 (L=30 mm); AISI S2; 5/16" (7.9 mm): 8, 10, 12, 14 mm (L=30 mm); AISI S2; 1/4" (6.3 mm): 4, 5.5, 7 mm (L=37 mm); AISI S2 / CrV 6150; 1/4" (6.3 mm): PH1, PH2 (L=37 mm); AISI S2 / CrV 6150; 1/4" (6.3 mm): PZ1, PZ2 (L=37 mm); AISI S2 / CrV 6150; 1/4" (6.3 mm): T8, T10, T15, T20, T25, T30 (L=37 mm); AISI S2 / CrV 6150; 1/4" (6.3 mm): 3, 4, 5, 6 mm (L=37 mm); AISI S2 / CrV 6150; 1.5, 2.0, 2.5 mm; CrV 6150

| YATO | 1/2" (12.7 mm) | 1/4" (6.3 mm) | 4 |
|---------|----------------|---------------|---|
| YT-1268 | | | |

GB Tool set
D Sechskant-Steckschlüssel-Satz
PL Zestaw narzędziowy

RUS Набор инструмента
CZ Sada nástrčných klíčů a ráčny
H Dugókulcs készlet racsnis hajtókarral

RO Rotrușa chei tubulare cu antrenor
E Juego de herramientas
CN 套筒扳手组套

| | |
|------------|----------|
| 1/2" | 1/4" |
| 12.5mm | 6.3mm |
| CrV 6140 | CrV 6150 |
| CrV 50BV30 | S2 |
| 72T | AS-DRIVE |

2



BMC & COLOR SLEEVE L SIZE



108
PCS

1/2" (12.7 mm): 10, 11, 12, 13, 14, 15, 16, 17, 18, 19, 20, 21, 22, 24 mm (L=38 mm); 27, 30, 32 mm (L=42 mm), 1/4" (6.3 mm): 4, 4.5, 5, 5.5, 6, 7, 8, 9, 10, 11, 12, 13, 14 mm (L=25 mm); CrV 50BV30: 1/2" (12.7 mm): 14, 15, 17, 19, 22 mm (L=76 mm), 1/4" (6.3 mm): 6, 7, 8, 9, 10, 11, 12, 13 mm (L=50 mm); CrV 50BV30: 1/2" (12.7 mm): E10, E11, E12, E14, E16, E18, E20, E24, 1/4" (6.3 mm): E4, E5, E6, E7, E8; CrV 50BV30: 1/2" (12.7 mm): (127, 254 mm), 1/4" (6.3 mm): (50.8, 101.6 mm); CrV 50BV30: 3/8" (9.5 mm) (F) x 1/2" (12.7 mm) (M); CrV 50BV30: 1/2" (12.7 mm), 1/4" (6.3 mm); CrV 50BV30: 1/2" (12.7 mm): 16, 21 mm; CrV 50BV30: 1/4" (6.3 mm): (152.4 mm); CrV 50BV30: 1/2" (12.7 mm): (255 mm), 1/4" (6.3 mm): (155 mm); 72T; CrV 6140: 1/4" (6.3 mm): (150 mm); CrV 50BV30: 1/2" (12.7 mm) x 5/16" (7.9 mm); CrV 6140: 5/16" (7.9 mm): 8, 10, 12 mm (L=30 mm); AISI S2: 5/16" (7.9 mm): PH3, PH4 (L=30 mm); AISI S2: 5/16" (7.9 mm): PZ3, PZ4 (L=30 mm); AISI S2: 5/16" (7.9 mm): T40, T45, T50, T55, T60 (L=30 mm); AISI S2: 5/16" (7.9 mm): 7, 8, 10, 12, 14 mm (L=30 mm); AISI S2: 1/4" (6.3 mm): 4, 5, 5.5, 6, 5 mm (L=37 mm); AISI S2 / CrV 6150: 1/4" (6.3 mm): PH1, PH2 (L=37 mm); AISI S2 / CrV 6150: 1/4" (6.3 mm): PZ1, PZ2 (L=37 mm); AISI S2 / CrV 6150: 1/4" (6.3 mm): T8, T10, T15, T20, T25, T27, T30 (L=37 mm); AISI S2 / CrV 6150: 1/4" (6.3 mm): 3, 4, 5, 6 mm (L=37 mm); AISI S2 / CrV 6150: 1.5, 2.0, 2.5 mm; CrV 6150

| YATO | 1/2" (12.7 mm) | 1/4" (6.3 mm) | 2 |
|---------|----------------|---------------|---|
| YT-3879 | | | |



BMC & COLOR SLEEVE XXL SIZE



109
PCS

CrV 55

SVCV 55

1/2" (12.7 mm): 12, 13, 14, 15, 16, 17, 18, 19, 20, 21, 22, 24 mm (L=38 mm); 27, 30, 32 mm (L=42 mm), 1/4" (6.3 mm): 4, 4.5, 5, 5.5, 6, 7, 8, 9, 10, 11, 12, 13, 14 mm (L=25 mm); CrV 50BV30: 1/2" (12.7 mm): 10, 12, 13, 14, 17, 19 mm (L=76 mm), 1/4" (6.3 mm): 4, 5, 6, 7, 8, 9 mm (L=50 mm); CrV 50BV30: 1/2" (12.7 mm): E10, E12, E14, E16, E18, E20, E22, E24; CrV 50BV30: 1/2" (12.7 mm), 1/4" (6.3 mm); CrV 50BV30: 3/8" (9.5 mm) (F) x 1/2" (12.7 mm) (M), 3/8" (9.5 mm) (F) x 1/4" (6.3 mm) (M); CrV 50BV30: 1/2" (12.7 mm), 1/4" (6.3 mm); CrV 50BV30: 1/2" (12.7 mm): 16, 21 mm; CrV 50BV30: 1/2" (12.7 mm): (255 mm), 1/4" (6.3 mm): (155 mm); 72T; CrV 6140: 1/4" (6.3 mm): (150 mm); CrV 50BV30: 1/4" (6.3 mm): 4.0, 5.5, 6.5 mm (L=37 mm); AISI S2 / CrV 6150: 1/4" (6.3 mm): PH1, PH2, PH3 (L=37 mm); AISI S2 / CrV 6150: 1/4" (6.3 mm): PZ2, PZ3 (L=37 mm); AISI S2 / CrV 6150: 1/4" (6.3 mm): T8, T10, T15, T20, T25 (L=37 mm); AISI S2 / CrV 6150: 1/4" (6.3 mm): T10, T15, T20, T25, T40 (L=37 mm); AISI S2 / CrV 6150: 1/4" (6.3 mm): 3, 4, 5, 6 mm (L=37 mm); AISI S2 / CrV 6150: 8, 9, 10, 11, 12, 13, 14, 15, 16, 17, 18, 19 mm; CrV: 8x9, 10x11, 12x13, 14x15 mm; CrV 6140: 8x10, 12x13, 17x19 mm; CrV 6140: 3x75, 4x100, 6.5x150, PH1x75, PH2x100, PH3x150 mm; SVCV55: 180 mm; CrV 55: 300 g

| YATO | 1/2" (12.7 mm) | 1/4" (6.3 mm) | 2 |
|---------|----------------|---------------|---|
| YT-3889 | | | |

GB Tool set
D Sechskant-Steckschlüssel-Satz
PL Zestaw narzędziowy

RUS Набор инструмента
CZ Sada nástrčných klíčů a ráčny
H Dugókulcs készlet racsnis hajtókarral

RO Rotrușa chei tubulare cu antrenor
E Juego de herramientas
CN 套筒扳手组套

BMC & COLOR SLEEVE
XXL SIZE



| | | |
|------------|----------------|---------------|
| 122 PCS | 1/2" 12.5mm | 1/4" 6.3mm |
| | CrV 6140 | CrV 6150 |
| | CrV 50BV30 | S2 |
| | CrV 55 | SVCM 55 |
| | 72T | AS-DRIVE |



1/2" (12.7 mm): 12, 13, 14, 15, 16, 17, 18, 19, 20, 21, 22, 24 mm (L=38 mm); 27, 30, 32 mm (L=42 mm), 1/4" (6.3 mm): 4, 4.5, 5, 5.5, 6, 7, 8, 9, 10, 11, 12, 13, 14 mm (L=25 mm); CrV 50BV30: 1/2" (12.7 mm): 10, 12, 13, 14, 17, 19 mm (L=76 mm), 1/4" (6.3 mm): 4, 5, 6, 7, 8, 9 mm (L=50 mm); CrV 50BV30: 1/2" (12.7 mm): E10, E12, E14, E16, E18, E20, E22, E24; CrV 50BV30: 1/2" (12.7 mm): (254 mm), 1/4" (6.3 mm): (152.4 mm); CrV 50BV30: 3/8" (9.5 mm) (F) x 1/2" (12.7 mm) (M), 3/8" (9.5 mm) (F) x 1/4" (6.3 mm) (M); CrV 50BV30: 1/2" (12.7 mm), 1/4" (6.3 mm); CrV 50BV30: 1/2" (12.7 mm): 16, 21 mm; CrV 50BV30: 1/2" (12.7 mm): (255 mm), 1/4" (6.3 mm): (155 mm); 72T: CrV 6140: 1/4" (6.3 mm); (150 mm); CrV 50BV30: 1/4" (6.3 mm) x 1/4" (6.3 mm); CrV 6140: 1/4" (6.3 mm): 3, 4, 5, 6 mm (L=25 mm); AISI S2: 1/4" (6.3 mm): PH0, PH1, PH2 (L=25 mm); AISI S2: 1/4" (6.3 mm): PZ0, PZ1, PZ2 (L=25 mm); AISI S2: 1/4" (6.3 mm): 4.0, 5.5, 6.5 mm (L=37 mm); AISI S2 / CrV 6150: 1/4" (6.3 mm): PH1, PH2, PH3 (L=37 mm); AISI S2 / CrV 6150: 1/4" (6.3 mm): PZ2, PZ3 (L=37 mm); AISI S2 / CrV 6150: 1/4" (6.3 mm): T8, T10, T15, T20, T25 (L=37 mm); AISI S2 / CrV 6150: 1/4" (6.3 mm): T10, T15, T20, T25, T40 (L=37 mm); AISI S2 / CrV 6150: 1/4" (6.3 mm): 3, 4, 5, 6 mm (L=37 mm); AISI S2 / CrV 6150: 8, 9, 10, 11, 12, 13, 14, 15, 16, 17, 18, 19 mm; CrV: 4x100, 6.5x150, PH2x100, PH3x150 mm; SVCM55: 180 mm; CrV 55: 160 mm; CrV 55: 160 mm; CrV 55: 250 mm; CrV: 2, 2.5, 3, 4, 5, 6, 7, 8, 10 mm; CrV 6150

| | | | |
|-------------|----------------|---------------|---|
| YATO | ○ | ○ | 📦 |
| YT-3890 | 1/2" (12.7 mm) | 1/4" (6.3 mm) | 2 |

GB Tool set
D Sechskant-Steckschlüssel-Satz
PL Zestaw narzędziowy

RUS Набор инструмента
CZ Sada nástrčných klíčů a ráčny
H Dugókulcs készlet racsnis hajtókarral

RO Rotrușa chei tubulare cu antrenor
E Juego de herramientas
CN 套筒扳手组套

BMC & COLOR SLEEVE
XL SIZE



| | | | |
|------------|----------------|--------------|---------------|
| 111 PCS | 1/2" 12.5mm | 3/8" 10mm | 1/4" 6.3mm |
| | CrV 6140 | CrV 6150 | CrV 50BV30 |
| | S2 | 72T | AS-DRIVE |



1/2" (12.7 mm): 14, 15, 16, 17, 18, 19, 20, 21, 22, 23, 24 mm (L=38 mm); 27, 30, 32 mm (L=42 mm), 3/8" (9.5 mm): 9, 10, 11, 12, 13, 14, 15, 16 mm (L=28 mm); 17, 18, 19 mm (L=30 mm), 1/4" (6.3 mm): 3.5, 4, 4.5, 5, 5.5, 6, 7, 8, 9, 10, 11, 12, 13 mm (L=25 mm); CrV 50BV30: 1/2" (12.7 mm): (127, 254 mm), 3/8" (9.5 mm): (76, 152.4 mm), 1/4" (6.3 mm): (50.8, 152.4 mm); CrV 50BV30: 3/8" (9.5 mm) (F) x 1/2" (12.7 mm) (M), 1/2" (12.7 mm) (F) x 3/8" (9.5 mm) (M), 3/8" (9.5 mm) (F) x 1/4" (6.3 mm) (M); CrV 50BV30: 1/2" (12.7 mm), 3/8" (9.5 mm), 1/4" (6.3 mm); CrV 50BV30: 1/2" (12.7 mm): 16, 21 mm, 3/8" (9.5 mm); 16, 21 mm; CrV 50BV30: 1/2" (12.7 mm): (255 mm), 3/8" (9.5 mm): (200 mm), 1/4" (6.3 mm): (155 mm); 72T: CrV 6140: 1/4" (6.3 mm): (150 mm); CrV 50BV30: 1/2" (12.7 mm) x 5/16" (7.9 mm), 3/8" (9.5 mm) x 5/16" (7.9 mm); CrV 6140: 5/16" (7.9 mm): T27, T30, T35, T40, T45 (L=30 mm); AISI S2: 5/16" (7.9 mm): PH2, PH3 (L=30 mm); AISI S2: 5/16" (7.9 mm): PZ2, PZ3 (L=30 mm); AISI S2: 5/16" (7.9 mm): T27, T30, T35, T40, T45 (L=30 mm); AISI S2: 5/16" (7.9 mm): 5.5, 6, 6.5 mm (L=30 mm); AISI S2: 1/4" (6.3 mm): 4, 5.5, 6.5 mm (L=37 mm); AISI S2 / CrV 6150: 1/4" (6.3 mm): PH1, PH2 (L=37 mm); AISI S2 / CrV 6150: 1/4" (6.3 mm): PZ1, PZ2 (L=37 mm); AISI S2 / CrV 6150: 1/4" (6.3 mm): T8, T10, T15, T20, T25 (L=37 mm); AISI S2 / CrV 6150: 1/4" (6.3 mm): T10, T15, T20, T25, T40 (L=37 mm); AISI S2 / CrV 6150: 1/4" (6.3 mm): 3, 4, 5, 6 mm (L=37 mm); AISI S2 / CrV 6150: 8, 9, 10, 11, 12, 13, 14, 15, 16, 17, 18, 19 mm; CrV: 1.5, 2, 2.5 mm; CrV 6150

| | | | |
|-------------|----------------|---------------|---------------|
| YATO | ○ | ○ | 📦 |
| YT-3883 | 1/2" (12.7 mm) | 3/8" (9.5 mm) | 1/4" (6.3 mm) |

GB Tool set
D Sechskant-Steckschlüssel-Satz
PL Zestaw narzędziowy

RUS Набор инструмента
CZ Sada nástrčných klíčů a ráčny
H Dugókulcs készlet racsnis hajtókkal

RO Rotrusa chei tubulare cu antrenor
E Juego de herramientas
CN 套筒扳手组套

| | | |
|----------------|--------------|---------------|
| 1/2" 12.5mm | 3/8" 10mm | 1/4" 6.3mm |
| CrV 6140 | CrV 6150 | CrV 50BV30 |
| S2 | 72T | AS-DRIVE |

2



BMC & COLOR SLEEVE
XL SIZE



120
PCS

METRIC
& S.A.E.

1/2" (12.7 mm): 20, 21, 22, 24 mm (L=38 mm); 27, 30, 32 mm (L=42 mm); 3/8" (9.5 mm): 9, 10, 11, 12, 13, 14, 15, 16 mm (L=28 mm); 17, 18, 19 mm (L=30 mm); 1/4" (6.3 mm): 4, 5, 6, 7, 8, 9, 10, 11, 12, 13 mm (L=25 mm); CrV 50BV30: 1/2" (12.7 mm): 13, 14, 15, 17 mm (L=63 mm); 1/4" (6.3 mm): 8, 9, 10, 12 mm (L=50 mm); CrV 50BV30: 1/2" (12.7 mm) x 15/16" (23.8 mm); 1/2" (12.7 mm) x 1" (25.4 mm); 1/2" (12.7 mm) x 1-1/16" (27.0 mm); 1/2" (12.7 mm) x 1-1/4" (31.8 mm); 3/8" (9.5 mm) x 3/8" (9.5 mm); 3/8" (9.5 mm) x 7/16" (11.1 mm); 3/8" (9.5 mm) x 1/2" (12.7 mm); 3/8" (9.5 mm) x 9/16" (14.3 mm); 3/8" (9.5 mm) x 5/8" (15.9 mm); 3/8" (9.5 mm) x 11/16" (17.5 mm); 3/8" (9.5 mm) x 3/4" (19.0 mm); 3/8" (9.5 mm) x 13/16" (20.6 mm); 3/8" (9.5 mm) x 7/8" (22.2 mm); 1/4" (6.3 mm) x 5/32" (4.0 mm); 1/4" (6.3 mm) x 3/16" (4.8 mm); 1/4" (6.3 mm) x 7/32" (5.6 mm); 1/4" (6.3 mm) x 1/4" (6.3 mm); 1/4" (6.3 mm) x 9/32" (7.1 mm); 1/4" (6.3 mm) x 5/16" (7.9 mm); 1/4" (6.3 mm) x 11/32" (8.7 mm); 1/4" (6.3 mm) x 3/8" (9.5 mm); 1/4" (6.3 mm) x 7/16" (11.1 mm); 1/4" (6.3 mm) x 1/2" (12.7 mm); CrV 50BV30: 1/2" (12.7 mm): 17, 19, 21, 23 mm; CrV 50BV30: 3/8" (9.5 mm): E8, E10, E11, E12, E14, E16, E18, E20; CrV 50BV30: 1/2" (12.7 mm): (127, 254 mm); 3/8" (9.5 mm): (76, 152.4 mm); 1/4" (6.3 mm): (50.8 mm); CrV 50BV30: 1/2" (12.7 mm): 3/8" (9.5 mm); 1/4" (6.3 mm); CrV 50BV30: 3/8" (9.5 mm): 16, 21 mm; CrV 50BV30: 1/2" (12.7 mm): (255 mm); 3/8" (9.5 mm): (200 mm); 1/4" (6.3 mm): (155 mm); 72T: CrV 6140: 1/4" (6.3 mm): (150 mm); CrV 50BV30: 1/4" (6.3 mm) x 1/4" (6.3 mm); CrV 6140: 1/4" (6.3 mm): T10, T15, T20, T25, T27, T30, T40 (L=25 mm); AISI S2: 3/8" (9.5 mm): 5.5, 6.5 mm (L=50 mm); AISI S2 / CrV 6150: PH1, PH2 (L=50 mm); PH1, PH2 (L=50 mm); AISI S2 / CrV 6150: 3/8" (9.5 mm): PZ1, PZ2 (L=50 mm); AISI S2 / CrV 6150: 3/8" (9.5 mm): T20, T30, T40, T45, T50, T55, T60 (L=50 mm); AISI S2 / CrV 6150: 3/8" (9.5 mm): 3, 4, 5, 6 mm (L=50 mm); AISI S2 / CrV 6150: 8, 9, 10, 11, 12, 13, 14, 17, 18, 19 mm; CrV

| YATO | 1/2" (12.7 mm) | 3/8" (9.5 mm) | 1/4" (6.3 mm) | 2 |
|---------|----------------|---------------|---------------|---|
| YT-3880 | | | | |



BMC & COLOR SLEEVE
XL SIZE



128
PCS

1/2" (12.7 mm): 14, 15, 16, 17, 18, 19, 20, 21, 22, 24 mm (L=38 mm); 27, 30, 32 mm (L=42 mm); 3/8" (9.5 mm): 10, 11, 12, 13, 14, 15, 16 mm (L=28 mm); 17, 18 mm (L=30 mm); 1/4" (6.3 mm): 6, 7, 8, 9, 10, 11, 12, 13 mm (L=25 mm); CrV 50BV30: 1/2" (12.7 mm): 17, 18, 19, 22 mm (L=76 mm); 3/8" (9.5 mm): 8, 10, 12, 13, 14, 15 mm (L=63 mm); 1/4" (6.3 mm): 6, 7, 8, 10, 12, 13 mm (L=50 mm); CrV 50BV30: 1/2" (12.7 mm): 17, 19, 21, 22 mm; CrV 50BV30: 3/8" (9.5 mm): E8, E10, E11, E12, E14, E16; CrV 50BV30: 1/2" (12.7 mm): (127, 254 mm); 3/8" (9.5 mm): (152.4 mm); 1/4" (6.3 mm): (50.8, 101.6 mm); CrV 50BV30: 3/8" (9.5 mm) (F) x 1/2" (12.7 mm) (M); CrV 50BV30: 1/2" (12.7 mm); 3/8" (9.5 mm); 1/4" (6.3 mm); CrV 50BV30: 1/2" (12.7 mm): 16, 21 mm; CrV 50BV30: 3/8" (9.5 mm): (198 mm); 1/4" (6.3 mm): (152.4 mm); CrV 50BV30: 1/2" (12.7 mm); (255 mm); 3/8" (9.5 mm); (200 mm); 1/4" (6.3 mm); (155 mm); 72T: CrV 6140: 1/4" (6.3 mm): (150 mm); CrV 50BV30: 1/2" (12.7 mm): (250 mm); CrV 50BV30: 3/8" (9.5 mm) x 5/16" (7.9 mm); CrV 6140: 1/2" (12.7 mm) x 3/8" (9.5 mm); 3/8" (9.5 mm) x 1/4" (6.3 mm); CrV 50BV30: 1/4" (6.3 mm) x 1/4" (6.3 mm); CrV 6140: 3/8" (9.5 mm): 5.5, 6.5 mm (L=70 mm); AISI S2: 3/8" (9.5 mm): PH1, PH2, PH3 (L=70 mm); AISI S2: 3/8" (9.5 mm): T20, T30, T40, T45, T50, T55 (L=70 mm); AISI S2: 3/8" (9.5 mm): 6, 7, 8, 10, 12 mm (L=70 mm); AISI S2: 3/8" (9.5 mm): (6.3 mm): PZ1, PZ2 (L=25 mm); AISI S2: 1/4" (6.3 mm): T8, T10 (L=25 mm); AISI S2: 1/4" (6.3 mm): 4.0, 5.5, 6.5 mm (L=37 mm); AISI S2 / CrV 6150: 1/4" (6.3 mm): PH1, PH2 (L=37 mm); AISI S2 / CrV 6150: 1/4" (6.3 mm): T8, T10, T15, T20, T25, T30, T40 (L=37 mm); AISI S2 / CrV 6150: 1/4" (6.3 mm): 3, 4, 5, 6 mm (L=37 mm); AISI S2 / CrV 6150: 8, 10, 12, 13, 14, 15, 16, 17, 18, 19 mm; CrV: 1.5, 2, 2.5 mm; CrV 6150

| YATO | 1/2" (12.7 mm) | 3/8" (9.5 mm) | 1/4" (6.3 mm) | 2 |
|---------|----------------|---------------|---------------|---|
| YT-3887 | | | | |

GB Tool set
 D Sechskant-Steckschlüssel-Satz
 PL Zestaw narzędziowy

RUS Набор инструмента
 CZ Sada nástrčných klíčů a ráčny
 H Dugókulcs készlet racsnis hajtókarral

RO Rotruşa chei tubulare cu antrenor
 E Juego de herramientas
 CN 套筒扳手组套

BMC & COLOR SLEEVE
 XXL SIZE



| | | |
|----------------|--------------|---------------|
| 1/2" 12.5mm | 3/8" 10mm | 1/4" 6.3mm |
| CrV 6140 | CrV 6150 | CrV 50BV30 |
| S2 | 72T | AS-DRIVE |

2



129
PCS

CrV
55

SVCM
55

1/2" (12.7 mm): 12, 13, 14, 15, 16, 17, 18, 19, 20, 21, 22, 24 mm (L=38 mm); 27, 30, 32 mm (L=42 mm), 3/8" (9.5 mm): 10, 11, 12, 13, 14, 15, 16 mm (L=28 mm); 17, 18, 19 mm (L=30 mm), 1/4" (6.3 mm): 4, 4.5, 5, 5.5, 6, 7, 8, 9, 10, 11, 12, 13, 14 mm (L=25 mm); CrV 50BV30: 1/2" (12.7 mm): 10, 12, 13, 14, 17, 19 mm (L=76 mm), 1/4" (6.3 mm): 4, 5, 6, 7, 8, 9 mm (L=50 mm); CrV 50BV30: 1/2" (12.7 mm): 17, 19, 21, 23 mm; CrV 50BV30: 3/8" (9.5 mm): E8, E10, E11, E12, E14, E16, E18, E20; CrV 50BV30: 1/2" (12.7 mm): (127, 254 mm), 3/8" (9.5 mm): (76, 152.4 mm), 1/4" (6.3 mm): (50.8 mm); CrV 50BV30: 1/2" (12.7 mm), 3/8" (9.5 mm), 1/4" (6.3 mm); CrV 50BV30: 3/8" (9.5 mm): 16, 21 mm; CrV 50BV30: 1/2" (12.7 mm): (255 mm), 3/8" (9.5 mm): (200 mm), 1/4" (6.3 mm): (155 mm); 72T: CrV 6140: 1/4" (6.3 mm): (150 mm); CrV 50BV30: 3/8" (9.5 mm): 4.0, 5.5, 6.5 mm (L=50 mm); AISI S2 / CrV 6150: PH1, PH2, PH3 (L=50 mm); AISI S2 / CrV 6150: 3/8" (9.5 mm): PZ1, PZ2, PZ3 (L=50 mm); AISI S2 / CrV 6150: 3/8" (9.5 mm): T20, T30, T40, T45, T50, T55, T60 (L=50 mm); AISI S2 / CrV 6150: 3/8" (9.5 mm): 3, 4, 5, 6, 8, 10 mm (L=50 mm); AISI S2 / CrV 6150: 8, 10, 11, 12, 13, 14, 15, 16, 17, 18, 19, 22 mm; CrV: 3x75, 4x100, 6.5x150, PH1x75, PH2x100, PH3x150 mm; SVCM55: 180 mm; CrV 55: 160 mm; CrV 55: 1.5, 2, 2.5, 3, 4, 5, 6, 7, 8, 10 mm; CrV 6150

| YATO | | | | |
|---------|----------------|---------------|---------------|---|
| YT-3888 | 1/2" (12.7 mm) | 3/8" (9.5 mm) | 1/4" (6.3 mm) | 2 |



150
PCS

METRIC
& S.A.E.

1/2" (12.7 mm): 20, 21, 22, 24 mm (L=38 mm); 27, 30, 32 mm (L=42 mm), 3/8" (9.5 mm): 9, 10, 11, 12, 13, 14, 15, 16 mm (L=28 mm); 17, 18, 19 mm (L=30 mm), 1/4" (6.3 mm): 4, 5, 6, 7, 8, 9, 10, 11, 12, 13 mm (L=25 mm); CrV 50BV30: 1/2" (12.7 mm): 10, 12, 13, 14, 17, 19 mm (L=76 mm), 3/8" (9.5 mm): 10, 11, 12, 13, 14, 15 mm (L=63 mm), 1/4" (6.3 mm): 4, 5, 6, 7, 8, 9 mm (L=50 mm); CrV 50BV30: 1/2" (12.7 mm) x 15/16" (23.8 mm), 1/2" (12.7 mm) x 1" (25.4 mm), 1/2" (12.7 mm) x 1-1/16" (27.0 mm), 1/2" (12.7 mm) x 1-1/4" (31.8 mm), 3/8" (9.5 mm) x 3/8" (9.5 mm), 3/8" (9.5 mm) x 7/16" (11.1 mm), 3/8" (9.5 mm) x 1/2" (12.7 mm), 3/8" (9.5 mm) x 9/16" (14.3 mm), 3/8" (9.5 mm) x 5/8" (15.9 mm), 3/8" (9.5 mm) x 11/16" (17.5 mm), 3/8" (9.5 mm) x 3/4" (19.0 mm), 3/8" (9.5 mm) x 13/16" (20.6 mm), 3/8" (9.5 mm) x 7/8" (22.2 mm), 1/4" (6.3 mm) x 5/32" (4.0 mm), 1/4" (6.3 mm) x 3/16" (4.8 mm), 1/4" (6.3 mm) x 7/32" (5.6 mm), 1/4" (6.3 mm) x 1/4" (6.3 mm), 1/4" (6.3 mm) x 9/32" (7.1 mm), 1/4" (6.3 mm) x 5/16" (7.9 mm), 1/4" (6.3 mm) x 11/32" (8.7 mm), 1/4" (6.3 mm) x 3/8" (9.5 mm), 1/4" (6.3 mm) x 7/16" (11.1 mm), 1/4" (6.3 mm) x 1/2" (12.7 mm); CrV 50BV30: 1/2" (12.7 mm): 17, 19, 21, 23 mm; CrV 50BV30: 3/8" (9.5 mm): E8, E10, E11, E12, E14, E16, E18, E20; CrV 50BV30: 1/2" (12.7 mm): (127, 254 mm), 3/8" (9.5 mm): (76, 152.4 mm), 1/4" (6.3 mm): (50.8 mm); CrV 50BV30: 1/2" (12.7 mm), 3/8" (9.5 mm), 1/4" (6.3 mm); CrV 50BV30: 3/8" (9.5 mm): 16, 21 mm; CrV 50BV30: 1/2" (12.7 mm): (255 mm), 3/8" (9.5 mm): (200 mm), 1/4" (6.3 mm): (155 mm); 72T: CrV 6140: 1/4" (6.3 mm): (150 mm); CrV 50BV30: 1/4" (6.3 mm) x 1/4" (6.3 mm); CrV 6140: 1/4" (6.3 mm): T10, T15, T20, T25, T27, T30, T40 (L=25 mm); AISI S2: 3/8" (9.5 mm): 4, 5, 5.5, 6.5 mm (L=50 mm); AISI S2 / CrV 6150: PH1, PH2, PH3 (L=50 mm); AISI S2 / CrV 6150: 3/8" (9.5 mm): PZ1, PZ2, PZ3 (L=50 mm); AISI S2 / CrV 6150: 3/8" (9.5 mm): T20, T30, T40, T45, T50, T55, T60 (L=50 mm); AISI S2 / CrV 6150: 3/8" (9.5 mm): 3, 4, 5, 6, 8, 10 mm (L=50 mm); AISI S2 / CrV 6150: 8, 9, 10, 11, 12, 13, 14, 15, 16, 17, 18, 19 mm; CrV: 8x10, 12x13, 17x19 mm; 1.5, 2, 2.5, 3, 4

| YATO | | | | |
|---------|----------------|---------------|---------------|---|
| YT-3881 | 1/2" (12.7 mm) | 3/8" (9.5 mm) | 1/4" (6.3 mm) | 2 |

GB Tool set
D Sechskant-Steckschlüssel-Satz
PL Zestaw narzędziowy

RUS Набор инструмента
CZ Sada nástrčných klíčů a ráčny
H Dugókulcs készlet racsnis hajtókarral

RO Rotrusa chei tubulare cu antrenor
E Juego de herramientas
CN 套筒扳手组套

| | | |
|-----------------------|---------------------|----------------------|
| 1/2" 12.5mm | 3/8" 10mm | 1/4" 6.3mm |
| CrV 6140 | CrV 6150 | CrV 50BV30 |
| S2 | 72T | AS-DRIVE |

2



173
PCS

BMC
& COLOR
SLEEVE
XL SIZE



$\frac{1}{2}$ " (12.7 mm): 10, 11, 12, 13, 14, 15, 16, 17, 18, 19, 20, 21, 22, 23, 24 mm (L=38 mm); 27, 30, 32 mm (L=42 mm); $\frac{3}{8}$ " (9.5 mm): 10, 11, 12, 13, 14, 15, 16 mm (L=28 mm); 17, 18, 19 mm (L=30 mm), $\frac{1}{4}$ " (6.3 mm): 4, 4.5, 5, 5.5, 6, 7, 8, 9, 10, 11, 12, 13, 14 mm (L=25 mm); CrV 50BV30: $\frac{1}{2}$ " (12.7 mm): 16, 17, 18, 19, 22 mm (L=76 mm); $\frac{3}{8}$ " (9.5 mm): 10, 11, 12, 13, 14, 15 mm (L=63 mm), $\frac{1}{4}$ " (6.3 mm): 4, 5, 6, 7, 8, 9, 10 mm (L=50 mm); CrV 50BV30: $\frac{1}{2}$ " (12.7 mm): E18, E20, E24, $\frac{3}{8}$ " (9.5 mm): E10, E11, E12, E14, E16, $\frac{1}{4}$ " (6.3 mm): E4, E5, E6, E7, E8; CrV 50BV30: $\frac{1}{2}$ " (12.7 mm): (127, 254 mm), $\frac{3}{8}$ " (9.5 mm): (152.4 mm), $\frac{1}{4}$ " (6.3 mm): (50.8, 101.6 mm); CrV 50BV30: $\frac{3}{8}$ " (9.5 mm) (F) x $\frac{1}{2}$ " (12.7 mm) (M); CrV 50BV30: $\frac{1}{2}$ " (12.7 mm), $\frac{3}{8}$ " (9.5 mm); CrV 50BV30: $\frac{1}{2}$ " (12.7 mm); 16, 21 mm, $\frac{3}{8}$ " (9.5 mm); 18 mm; CrV 50BV30: $\frac{1}{2}$ " (12.7 mm); (255 mm), $\frac{3}{8}$ " (9.5 mm): (200 mm), $\frac{1}{4}$ " (6.3 mm): (155 mm); 72T: CrV 6140: $\frac{1}{4}$ " (6.3 mm): (150 mm); CrV 50BV30: $\frac{1}{2}$ " (12.7 mm) x $\frac{5}{16}$ " (7.9 mm), $\frac{3}{8}$ " (9.5 mm) x $\frac{5}{16}$ " (7.9 mm); CrV 6140: $\frac{1}{4}$ " (6.3 mm) x $\frac{1}{4}$ " (6.3 mm); CrV 6140: $\frac{5}{16}$ " (7.9 mm); 8, 10, 12 mm (L=30 mm); AISI S2: $\frac{5}{16}$ " (7.9 mm): PH3, PH4 (L=30 mm); AISI S2: $\frac{5}{16}$ " (7.9 mm): PZ3, PZ4 (L=30 mm); AISI S2: $\frac{5}{16}$ " (7.9 mm): T40, T45, T50, T55, T60, T70 (L=30 mm); AISI S2: $\frac{5}{16}$ " (7.9 mm): T40, T45, T50, T55, T60, T70 (L=30 mm); AISI S2: $\frac{5}{16}$ " (7.9 mm): 7, 8, 10, 12, 14 mm (L=30 mm); AISI S2: $\frac{1}{4}$ " (6.3 mm): T5, T6, T7 (L=25 mm); AISI S2: $\frac{1}{4}$ " (6.3 mm): T7, T10, T15, T20, T25, T27, T30, T40, T45 (L=25 mm); AISI S2: $\frac{1}{4}$ " (6.3 mm): M5, M6, M8 (L=25 mm); AISI S2: $\frac{1}{4}$ " (6.3 mm): RM5, RM6, RM7, RM8, RM9 (L=25 mm); AISI S2: $\frac{1}{4}$ " (6.3 mm): 4, 5.5, 6.5, 7 mm (L=37 mm); AISI S2 / CrV 6150: $\frac{1}{4}$ " (6.3 mm): PH0, PH1, PH2 (L=37 mm); AISI S2 / CrV 6150: $\frac{1}{4}$ " (6.3 mm): PZ0, PZ1, PZ2 (L=37 mm); AISI S2 / CrV 6150: $\frac{1}{4}$ " (6.3 mm): T8, T9, T10, T15, T20, T25, T27, T30 (L=37 mm); AISI S2 / CrV 6150: $\frac{1}{4}$ " (6.3 mm): T8, T9, T10, T15, T20, T25, T27, T30 (L=37 mm); AISI S2 / CrV 6150: $\frac{1}{4}$ " (6.3 mm): 3, 4, 5, 6 mm (L=37 mm); AISI S2 / CrV 6150: 1.25, 1.5, 2, 2.5, 3, 4, 5 mm; CrV 6150

| | | | | |
|-------------|---------------------------|--------------------------|--------------------------|---|
| YATO | | | | |
| YT-3893 | $\frac{1}{2}$ " (12.7 mm) | $\frac{3}{8}$ " (9.5 mm) | $\frac{1}{4}$ " (6.3 mm) | 2 |



216
PCS



BMC
& COLOR
SLEEVE
XXL SIZE



$\frac{1}{2}$ " (12.7 mm): 10, 11, 12, 13, 14, 15, 17, 19, 20, 21, 22, 24 mm (L=38 mm); 27, 30, 32 mm (L=42 mm), $\frac{3}{8}$ " (9.5 mm): 10, 11, 12, 13, 14, 15, 16 mm (L=28 mm); 17, 18, 19 mm (L=30 mm), $\frac{1}{4}$ " (6.3 mm): 4, 4.5, 5, 5.5, 6, 7, 8, 9, 10, 11, 12, 13, 14 mm (L=25 mm); CrV 50BV30: $\frac{1}{2}$ " (12.7 mm): 16, 17, 18, 19, 22 mm (L=76 mm); $\frac{3}{8}$ " (9.5 mm): 10, 11, 12, 13, 14, 15 mm (L=63 mm), $\frac{1}{4}$ " (6.3 mm): 4, 5, 6, 7, 8, 9, 10 mm (L=50 mm); CrV 50BV30: $\frac{1}{2}$ " (12.7 mm): E20, E22, E24, $\frac{3}{8}$ " (9.5 mm): E10, E11, E12, E14, E16, E18, $\frac{1}{4}$ " (6.3 mm): E4, E5, E6, E7, E8; CrV 50BV30: $\frac{1}{2}$ " (12.7 mm): (127, 254 mm), $\frac{3}{8}$ " (9.5 mm): (152 mm), $\frac{1}{4}$ " (6.3 mm): (50.8, 101.6 mm); CrV 50BV30: $\frac{1}{2}$ " (12.7 mm), $\frac{3}{8}$ " (9.5 mm), $\frac{1}{4}$ " (6.3 mm); CrV 50BV30: $\frac{1}{2}$ " (12.7 mm); 16, 21 mm, $\frac{3}{8}$ " (9.5 mm); 18 mm; CrV 50BV30: $\frac{1}{2}$ " (12.7 mm); (255 mm), $\frac{3}{8}$ " (9.5 mm): (200 mm), $\frac{1}{4}$ " (6.3 mm): (155 mm); 72T: CrV 6140: $\frac{1}{4}$ " (6.3 mm): (150 mm); CrV 50BV30: $\frac{1}{2}$ " (12.7 mm) x $\frac{5}{16}$ " (7.9 mm); $\frac{3}{8}$ " (9.5 mm) x $\frac{5}{16}$ " (7.9 mm); CrV 6140: $\frac{1}{4}$ " (6.3 mm) x $\frac{1}{4}$ " (6.3 mm); CrV 6140: $\frac{5}{16}$ " (7.9 mm); 6, 6.5, 8 mm (L=30 mm); AISI S2: $\frac{5}{16}$ " (7.9 mm): PH3, PH4 (L=30 mm); AISI S2: $\frac{5}{16}$ " (7.9 mm): T25, T27, T30, T35, 2xT40, T45, T50 (L=30 mm); AISI S2: $\frac{5}{16}$ " (7.9 mm): T27, T30, T35, T40, T45, T50 (L=30 mm); AISI S2: $\frac{5}{16}$ " (7.9 mm): 5.5, 6, 6.5, 7, 8 mm (L=30 mm); AISI S2: $\frac{5}{16}$ " (7.9 mm): M5, M6, M8, M10 (L=30 mm); AISI S2: $\frac{1}{4}$ " (6.3 mm): 4, 5, 5.5, 6 mm (L=25 mm); AISI S2: $\frac{1}{4}$ " (6.3 mm): PH1, PH2 (L=25 mm); AISI S2: $\frac{1}{4}$ " (6.3 mm): PZ1, PZ2 (L=25 mm); AISI S2: $\frac{1}{4}$ " (6.3 mm): T8, T10, T15, T20, T25 (L=25 mm); AISI S2: $\frac{1}{4}$ " (6.3 mm): T8, 2xT10, 2xT15, 2xT20, 2xT25, T40 (L=25 mm); AISI S2: $\frac{1}{4}$ " (6.3 mm): 3, 4, 5, 6 mm (L=25 mm); AISI S2: $\frac{1}{4}$ " (6.3 mm): 3, 4, 5, 6 mm (L=25 mm); AISI S2: $\frac{1}{4}$ " (6.3 mm): M5, M6, M8 (L=25 mm); AISI S2: $\frac{1}{4}$ " (6.3 mm): S1, S2 (L=25 mm); AISI S2: $\frac{1}{4}$ " (6.3 mm): PH1, PH2 (L=25 mm); AISI S2: $\frac{1}{4}$ " (6.3 mm): 1, 2, 3 mm (L=25 mm); AISI S2: $\frac{1}{4}$ " (6.3 mm): 6, 8, 10 mm (L=25 mm); AISI S2: $\frac{1}{4}$ " (6.3 mm): 4, 6, 8 mm (L=25 mm); AISI S2: $\frac{1}{2}$ " (12.7 mm): T55, T60 (L=50 mm); AISI S2 / CrV 6150: $\frac{1}{4}$ " (6.3 mm): 6, 6.5, 8 mm (L=37 mm); AISI S2 / CrV 6150: $\frac{1}{4}$ " (6.3 mm): PH3, PH4 (L=37 mm); AISI S2 / CrV 6150: $\frac{1}{4}$ " (6.3 mm): PZ3, PZ4 (L=37 mm); AISI S2 / CrV 6150: $\frac{1}{4}$ " (6.3 mm): T25, T27, T30, T35, 2xT40, T45, T50 (L=37 mm); AISI S2 / CrV 6150: $\frac{1}{4}$ " (6.3 mm): T27, T30, T35, T40, T45, T50 (L=37 mm); AISI S2 / CrV 6150: $\frac{1}{4}$ " (6.3 mm): 5.5, 6, 6.5, 7, 8 mm (L=37 mm); AISI S2 / CrV 6150: $\frac{1}{4}$ " (6.3 mm): M5, M6, M8, M10 (L=37 mm); AISI S2 / CrV 6150: $\frac{1}{4}$ " (6.3 mm): 8, 10, 11, 12, 13, 14, 15, 16, 17, 18, 19, 22 mm; CrV: 1.27, 1.5, 2, 2.5, 3, 4, 5 mm; CrV 6150

| | | | | |
|-------------|---------------------------|--------------------------|--------------------------|---|
| YATO | | | | |
| YT-3884 | $\frac{1}{2}$ " (12.7 mm) | $\frac{3}{8}$ " (9.5 mm) | $\frac{1}{4}$ " (6.3 mm) | 2 |

GB Tool set
D Sechskant-Steckschlüssel-Satz
PL Zestaw narzędziowy

RUS Набор инструмента
CZ Sada nástrčných klíčů a ráčny
H Dugókulcs készlet racsnis hajtókarral

RO Rotruşa chei tubulare cu antrenor
E Juego de herramientas
CN 套筒扳手组套

BMC & COLOR SLEEVE
XXXL SIZE



| | | |
|--------------------|--------------|---------------|
| 1/2" 12.5mm | 3/8" 10mm | 1/4" 6.3mm |
| CrV 6140 | CrV 6150 | CrV 50BV30 |
| S2 | 72T | AS-DRIVE |
| METRIC & S.A.E. | CrV 55 | MAGNETIC |

225
PCS



1/2" (12.7 mm): 10, 13, 15, 16, 17, 18, 19, 20, 21, 22, 23, 24 mm (L=38 mm); 27, 30, 32 mm (L=42 mm); 3/8" (9.5 mm): 10, 11, 12, 13, 14, 15, 16 mm (L=28 mm); 17, 18, 19 mm (L=30 mm); 1/4" (6.3 mm): 3.5, 4, 4.5, 5, 5.5, 6, 7, 8, 9, 10, 11, 12, 13, 14 mm (L=25 mm); CrV 50BV30: 1/2" (12.7 mm): 10, 11, 12, 13, 14, 15, 17, 19, 21 mm (L=76 mm); 3/8" (9.5 mm): 6, 7, 8, 9, 10 mm (L=63 mm); CrV 50BV30: 1/2" (12.7 mm) x 7/16" (11.1 mm), 1/2" (12.7 mm) x 1/2" (12.7 mm), 1/2" (12.7 mm) x 9/16" (14.3 mm), 1/2" (12.7 mm) x 5/8" (15.9 mm), 1/2" (12.7 mm) x 11/16" (17.5 mm), 1/2" (12.7 mm) x 3/4" (19.0 mm), 1/2" (12.7 mm) x 13/16" (20.6 mm), 1/2" (12.7 mm) x 7/8" (22.2 mm), 1/4" (6.3 mm) x 1/4" (6.3 mm), 1/4" (6.3 mm) x 9/32" (7.1 mm), 1/4" (6.3 mm) x 5/16" (7.9 mm), 1/4" (6.3 mm) x 11/32" (8.7 mm), 1/4" (6.3 mm) x 3/8" (9.5 mm); CrV 50BV30: 1/2" (12.7 mm): 17, 19, 21 mm; CrV 50BV30: 1/2" (12.7 mm): E16, E18, E20, E22, E24, 3/8" (9.5 mm); E10, E11, E12, E14, 1/4" (6.3 mm); E4, E5, E6, E7, E8; CrV 50BV30: 1/2" (12.7 mm): (127, 254 mm), 3/8" (9.5 mm): (76, 254 mm), 1/4" (6.3 mm): (50.8, 101.6 mm); CrV 50BV30: 3/8" (9.5 mm) (F) x 1/2" (12.7 mm) (M), 1/2" (12.7 mm) (F) x 3/8" (9.5 mm) (M); CrV 50BV30: 1/2" (12.7 mm), 3/8" (9.5 mm), 1/4" (6.3 mm); CrV 50BV30: 1/2" (12.7 mm): 16, 21 mm, 3/8" (9.5 mm); 18 mm; CrV 50BV30: 1/4" (6.3 mm); (152.4 mm); CrV 50BV30: 1/2" (12.7 mm): (255 mm), 3/8" (9.5 mm): (200 mm), 1/4" (6.3 mm): (155 mm); 72T: CrV 6140: 1/4" (6.3 mm); (150 mm); CrV 50BV30: 1/4" (6.3 mm); (200 mm); CrV 6140: 1/2" (12.7 mm) x 5/16" (7.9 mm), 3/8" (9.5 mm) x 5/16" (7.9 mm), 3/8" (9.5 mm) x 1/4" (6.3 mm); CrV 6140: 1/4" (6.3 mm) x 1/4" (6.3 mm); CrV 6140: 1/4" (6.3 mm) x 3/8" (9.5 mm) (L=50 mm), 1/4" (6.3 mm) x 1/4" (6.3 mm) (L=50 mm), 1/4" (6.3 mm) x 1/4" (6.3 mm) (L=25 mm); CrV 6140: 1/4" (6.3 mm) (L=60 mm); 5/16" (7.9 mm); T20, T25, T27, T30, T40, T45, T50, T55 (L=75 mm); AISI S2: 5/16" (7.9 mm); 8, 10 mm (L=30 mm); AISI S2: 5/16" (7.9 mm); PH3, PH4 (L=30 mm); AISI S2: 5/16" (7.9 mm); PZ3, PZ4 (L=30 mm); AISI S2: 5/16" (7.9 mm); T40, T45, T50, T55, T60, T70 (L=30 mm); AISI S2: 5/16" (7.9 mm); 10, 12, 14 mm (L=30 mm); AISI S2: 1/4" (6.3 mm): 3, 4, 5, 6, 5, 7, 8, 9 mm (L=25 mm); AISI S2: 1/4" (6.3 mm); PH0, PH1, PH2, PH3 (L=25 mm); AISI S2: 1/4" (6.3 mm); PZ0, PZ1, PZ2, PZ3 (L=25 mm); AISI S2: 1/4" (6.3 mm); T8, T9, T10, T15, T20, T25, T27, T30 (L=25 mm); AISI S2: 1/4" (6.3 mm); T8, T9, T10, T15, T20, T25, T27, T30 (L=25 mm); AISI S2: 1/4" (6.3 mm); 3, 4, 5, 6, 7, 8 mm (L=25 mm); AISI S2: 1/4" (6.3 mm); 4, 5, 6, 7, 8 mm (L=25 mm); AISI S2: 1/4" (6.3 mm); 4, 5, 6, 7, 8 mm (L=25 mm); AISI S2: 1/4" (6.3 mm); 1, 2, 3, 4 mm (L=25 mm); AISI S2: 1/4" (6.3 mm); 6, 8, 10 mm (L=25 mm); AISI S2: 1/4" (6.3 mm); 4, 6, 8, 10 mm (L=25 mm); AISI S2: 1/4" (6.3 mm); 8, 9, 10, 11, 12, 13, 14, 15, 16, 17, 19, 22 mm; CrV: 6.5x38 mm, PH2x38 mm; SVCM55: 180 mm; CrV 55: 250 mm; CrV: 2, 2.5, 3, 4, 5, 6, 7, 8, 10, 12 mm; CrV 6150

| | | | | |
|---------|----------------|---------------|---------------|---|
| YATO | 1/2" (12.7 mm) | 3/8" (9.5 mm) | 1/4" (6.3 mm) | 2 |
| YT-3894 | | | | |

GB Torx socket
D Torx-Steckschlüssel
PL Nasadka Torx
RUS Головка
CZ Nástavec Torx
H Hatszögű rátét Torx
RO Cheie tubulară Torx
E Boquilla Torx
CN 星型套筒

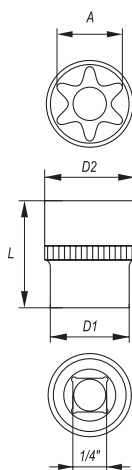

| | | |
|---------------|------|---------------|
| 1/4" 6.3mm | TORX | CrV 50BV30 |
|---------------|------|---------------|

COLOR BOX



| YATO | A (mm) | D1 (mm) | D2 (mm) | L (mm) | PCS packing | |
|----------|--------|---------|---------|--------|-------------|---------|
| YT-05211 | E4 | 11.9 | 6.7 | 25 | 24 | 240/480 |
| YT-05212 | E5 | 11.9 | 7.2 | 25 | 24 | 240/480 |
| YT-05213 | E6 | 11.9 | 8.3 | 25 | 24 | 240/480 |
| YT-05214 | E7 | 11.9 | 9.4 | 25 | 24 | 240/480 |
| YT-05215 | E8 | 11.9 | 10.0 | 25 | 24 | 240/480 |

GB Torx socket set
D Torx-Steckschlüsselsatz
PL Klucze nasadowe Torx
RUS Набор головок
CZ Nástrčné klíče
H Dugókulcs
RO Trusa tubulară
E Llaves de vaso
CN 星型套筒组套

| | | |
|----------|------|---------------|
| 9 PCS | TORX | CrV 50BV30 |
|----------|------|---------------|



1/4" (6.3 mm): E5, E6, E7, E8, 3/8" (9.5 mm): E10, E12, E14, E16;
1/4" (6.3 mm) (M) x 3/8" (9.5 mm) (F)

SLIDING
CARD



| | | |
|---------|---------------|-------|
| YATO | 1/4" (6.3 mm) | 10/40 |
| YT-0520 | | |

- GB Torx socket
- D Torx-Steckschlüssel
- PL Nasadka Torx
- RUS Головка
- CZ Nástavec Torx
- H Hatszögű rátét Torx
- RO Cheie tubulară Torx
- E Boquilla Torx
- CN 星型套筒

1/2" 12.5mm TORX CrV 50BV30

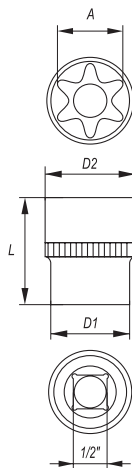

COLOR BOX



| YATO | A (mm) | D1 (mm) | D2 (mm) | L (mm) | PCS packing | |
|----------|--------|---------|---------|--------|-------------|---------|
| YT-05220 | E10 | 21.8 | 13.1 | 38 | 12 | 120/240 |
| YT-05221 | E11 | 21.8 | 13.9 | 38 | 12 | 120/240 |
| YT-05222 | E12 | 21.8 | 14.9 | 38 | 12 | 120/240 |
| YT-05223 | E14 | 21.8 | 16.3 | 38 | 12 | 120/240 |
| YT-05224 | E16 | 21.8 | 18.2 | 38 | 12 | 120/240 |
| YT-05225 | E18 | 23.8 | 19.4 | 38 | 12 | 120/240 |
| YT-05226 | E20 | 21.8 | 23.9 | 38 | 12 | 120/240 |
| YT-05227 | E22 | 23.2 | 25.7 | 38 | 12 | 120/240 |
| YT-05228 | E24 | 23.8 | 27.8 | 38 | 12 | 60/120 |

- GB Torx socket set
- RUS Набор головок
- RO Trusa tubulară
- D Torx-Steckschlüsselsatz
- CZ Nástronné klíče
- E Llaves de vaso
- PL Klucze nasadowe Torx
- H Dugókulcs
- CN 星型套筒组套

9 PCS TORX CrV 50BV30



1/2" (12.7 mm): E10, E11, E12, E14, E16, E18, E20, E22, E24

| YATO | | |
|---------|----------------|----|
| YT-0521 | 1/2" (12.7 mm) | 20 |

- GB Go-through socket set
- H Dugókulcs készlet, csavarászár átengedős
- BMC & COLOR SLEEVE
- D Durchgangs-Knarrenkasten
- RO Set chei tubulare cu crichet
- E Juego de boquillas con orificio pasante, con carraca
- PL Zestaw nasadek przelotowych z grzechotką
- RUS Набор торцевых головок сквозных с трещоткой
- CZ Sada průchodných nástroných klíčů
- CN 套筒扳手组套

21 PCS 1/2" 12.5mm 1/4" 6.3mm CrV 6140 CrV 50BV30 QUICK RELEASE SZYBKO-ZŁĄCZE METRIC IMPERIAL



- 10, 11, 12, 13, 14, 15, 16, 17, 18, 19 mm (L=32 mm); 3/8" (9.5 mm), 7/16" (11.1 mm), 1/2" (12.7 mm), 9/16" (14.3 mm), 5/8" (15.9 mm), 11/16" (17.5 mm), 3/4" (19.0 mm) (L=32 mm); CrV 50BV30;
- L=178 mm; CrV 6140; 1/2" (12.7 mm), 1/4" (6.3 mm); CrV 6140;
- 17 mm (L=75 mm); CrV 50BV30

| YATO | | | |
|---------|----------------|---------------|------|
| YT-3865 | 1/2" (12.7 mm) | 1/4" (6.3 mm) | 3/12 |

- GB Hexagonal socket
- D Sechskantenschlüssel
- PL Nasadka sześciokątna
- RUS Головка шестигранная
- CZ Sestihřanný nástavec
- H Hatszögű rátét
- RO Cheie tubulară hexagonală
- E Boquilla hexagonal
- CN 六角套筒

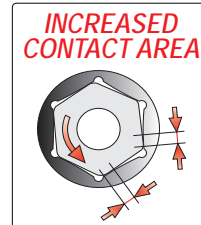
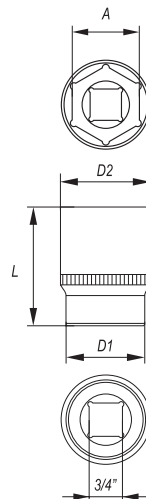

| | |
|--------|----------|
| 3/4" | DIN |
| 19 mm | 3121 |
| CrV | AS-DRIVE |
| 50BV30 | |

- application: industry, car service stations and workshops
- for high loads
- drive locks
- surface finish: chromed, satin
- przeznaczenie: przemysł, serwisy i warsztaty
- do największych obciążeń
- zamki blokujące
- wykończenie powierzchni: chromowana, satynowa

COLOR BOX



| YATO | Ø A (mm) | D1 (mm) | D2 (mm) | L (mm) | PCS packing | |
|---------|----------|---------|---------|--------|-------------|----|
| YT-1301 | 19 | 30 | 36 | 50 | 12 | 96 |
| YT-1302 | 21 | 32 | 36 | 50 | 12 | 96 |
| YT-1303 | 22 | 32 | 36 | 50 | 12 | 96 |
| YT-1304 | 23 | 34 | 36 | 50 | 12 | 96 |
| YT-1305 | 24 | 34 | 36 | 50 | 12 | 96 |
| YT-1306 | 25 | 36 | 36 | 50 | 12 | 96 |
| YT-1307 | 26 | 37 | 34 | 50 | 12 | 96 |
| YT-1308 | 27 | 38 | 34 | 50 | 12 | 96 |
| YT-1309 | 28 | 40 | 34 | 50 | 12 | 96 |
| YT-1310 | 29 | 40 | 35 | 50 | 12 | 96 |
| YT-1311 | 30 | 42 | 36 | 55 | 8 | 48 |
| YT-1312 | 32 | 44 | 37 | 55 | 8 | 48 |
| YT-1313 | 33 | 46 | 38 | 55 | 8 | 48 |

| YATO | Ø A (mm) | D1 (mm) | D2 (mm) | L (mm) | PCS packing | |
|---------|----------|---------|---------|--------|-------------|----|
| YT-1314 | 34 | 47 | 38 | 55 | 8 | 48 |
| YT-1315 | 35 | 48 | 42 | 60 | 6 | 36 |
| YT-1316 | 36 | 50 | 42 | 60 | 6 | 36 |
| YT-1317 | 38 | 52 | 45 | 60 | 6 | 36 |
| YT-1318 | 41 | 56 | 45 | 65 | 4 | 32 |
| YT-1319 | 42 | 57 | 45 | 65 | 4 | 32 |
| YT-1320 | 43 | 58 | 45 | 65 | 4 | 32 |
| YT-1322 | 46 | 62 | 48 | 70 | 4 | 32 |
| YT-1323 | 48 | 64 | 48 | 70 | 4 | 24 |
| YT-1324 | 50 | 68 | 48 | 70 | 4 | 24 |
| YT-1326 | 52 | 70 | 48 | 70 | 4 | 20 |
| YT-1328 | 55 | 73 | 48 | 75 | 4 | 20 |
| YT-1330 | 60 | 80 | 48 | 80 | 4 | 20 |

- GB Extension bar
- D Verlängerung
- PL Przedłużka
- RUS Удлинитель для воротка
- CZ Prodlužovací příravek
- H Toldalék
- RO Prelungitor
- E Tubo de prolongación
- CN 接杆

| | | |
|-------|------|--------|
| 3/4" | DIN | CrV |
| 19 mm | 3121 | 50BV30 |

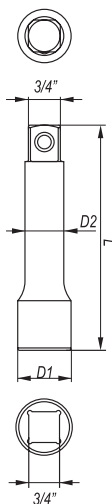

COLOR BOX

| YATO | Ø | D1 (mm) | D2 (mm) | L (mm) | PCS packing | |
|---------|----------------|---------|---------|--------|-------------|----|
| YT-1340 | 3/4" (19.0 mm) | 36 | 22 | 100 | 6 | 36 |
| YT-1341 | 3/4" (19.0 mm) | 36 | 22 | 200 | 5 | 20 |
| YT-1342 | 3/4" (19.0 mm) | 36 | 22 | 400 | 5 | 10 |

- GB Sliding T-bar
- D Handgriff mit Gleitstück
- PL Pokrętko typu „T”
- RUS Вороток T-образный
- CZ Otočná ráčka typ „T”
- H „T” alakú hajtókar
- RO Măner clupă tipul „T”
- E Mango tipo „T”
- CN 滑杆

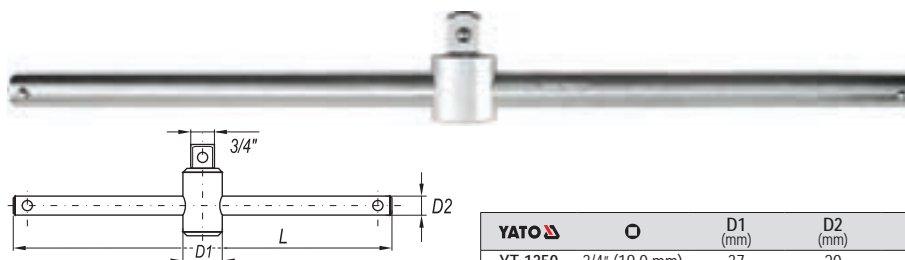

| YATO | Ø | D1 (mm) | D2 (mm) | L (mm) | PCS packing | |
|---------|----------------|---------|---------|--------|-------------|----|
| YT-1350 | 3/4" (19.0 mm) | 37 | 20 | 500 | 5 | 10 |

COLOR BOX



- GB Adapter
- D Reduktion
- PL Redukcja
- RUS Переходник
- CZ Redukce
- H Redució
- RO Reducție
- E Reducció
- CN 转换头

| | | |
|-------|------|--------|
| 3/4" | DIN | CrV |
| 19 mm | 3121 | 50BV30 |

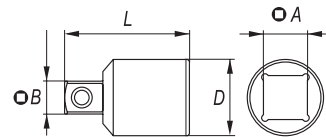

COLOR BOX



| YATO | Ø A | Ø B | D (mm) | L (mm) | PCS packing | |
|---------|----------------|--------------------|--------|--------|-------------|----|
| YT-1355 | 3/4" (19.0 mm) | (F) 1/2" (12.7 mm) | (M) 36 | 53 | 12 | 48 |

- GB Universal joint
- D Kardangelenk
- PL Przegub Cardana
- RUS Карданный шарнир
- CZ Kardanový kloub
- H Kardán csukló
- RO Articulație Cardanică
- E Articulación Cardan
- CN 万向接头

| | | |
|-------|------|--------|
| 3/4" | DIN | CrV |
| 19 mm | 3121 | 50BV30 |

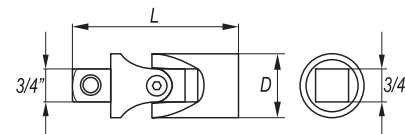

COLOR BOX



| YATO | Ø | D (mm) | L (mm) | PCS packing | |
|---------|----------------|--------|--------|-------------|----|
| YT-1352 | 3/4" (19.0 mm) | 40 | 106 | 12 | 36 |

- GB Flexible handle
- D Gelenkgriff
- PL Pokręto lamane
- RUS Вороток шарнирный
- CZ Otočná lomená ráčka
- H Hajlított hajtókar
- RO Prelungitor cu prindere flexibilă
- E Mango articulado
- CN 转向手柄

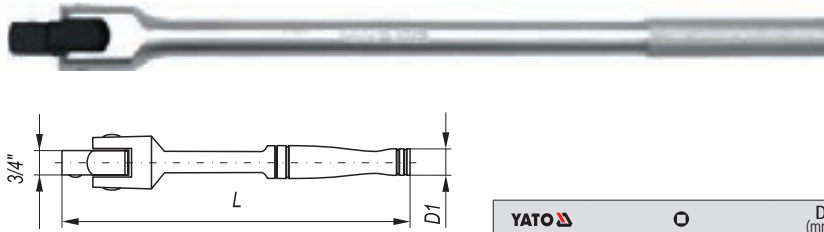

3/4"
19 mm **DIN 3121** **CrV 50BV30**

COLOR BOX

| YATO | Ø | D (mm) | L (mm) | PCS packing: | |
|---------|----------------|--------|--------|--------------|----|
| YT-1345 | 3/4" (19.0 mm) | 25 | 507 | 5 | 10 |

- GB L-type handle
- D Admutterschlüssel
- PL Pokręto typu „L”
- RUS Вороток 1/2" тип „L”
- CZ Páka zahnutá
- H „L” alakú hajtókar
- RO Mâner clupă tipul „L”
- E Mango tipo „L”
- CN L型套筒扳手



3/4"
19 mm **DIN 3121** **CrV 50BV30**

COLOR BOX

| YATO | Ø | D (mm) | L (mm) | PCS packing: | |
|---------|----------------|--------|--------|--------------|----|
| YT-1347 | 3/4" (19.0 mm) | 25 | 385 | 5 | 10 |
| YT-1348 | 3/4" (19.0 mm) | 25 | 440 | 5 | 10 |

- GB Quick release ratchet handle
- D Hebelumschaltknarre
- PL Grzechotka
- RUS Трещотка
- CZ Řehtačka
- H Racsnis hajtókar
- RO Dispozitiv de prindere cu clichet
- E Carraca
- CN 快速脱落棘轮扳手



3/4"
19 mm **DIN 3122** **24T**

QUICK RELEASE SZYBKO-ZŁĄCZE **CrV 6140**

COLOR BOX

| YATO | Ø | T | L (mm) | |
|---------|----------------|----|--------|----|
| YT-1360 | 3/4" (19.0 mm) | 24 | 500 | 10 |

- GB Socket set
- D Sechskant-Steckschlüssel-Satz
- PL Komplet nasadek z akcesoriami
- RUS Набор насадок
- CZ Sada nástrčných kľúčů a ráčny

- H Dugókulcs készlet racsnis hajtókarokkal
- RO Rotrusa chei tubulare cu antrenor
- E Juego de boquillas con accesorios
- CN 套筒扳手套组



3/4"
19 mm **CrV 6140** **CrV 50BV30**

QUICK RELEASE SZYBKO-ZŁĄCZE **24T**

AS-DRIVE



15
PCS

| YATO | Ø | |
|---------|----------------|---|
| YT-1334 | 3/4" (19.0 mm) | 1 |

3/4" (19.0 mm): 30, 32, 34 (L=55 mm); 36, 38 (L=60 mm); 41 (L=65 mm); 46, 50 (L=70 mm); 55 (L=75 mm); 60 mm (L=80 mm); CrV 50BV30; 3/4" (19.0 mm); (L=500 mm); 24T; CrV 6140; 3/4" (19.0 mm); (L=500 mm); CrV 50BV30; 3/4" (19.0 mm); (L=100, 200 mm); CrV 50BV30; 3/4" (19.0 mm); (L=106 mm); CrV 50BV30

3/4" (19.0 mm): 19, 21, 22, 24 mm (L=50 mm); 26, 27, 28 mm (L=52 mm); 30, 32 mm (L=53 mm); 33, 34 mm (L=56 mm); 36 mm (L=58 mm); 38 mm (L=60 mm); 41 mm (L=64 mm); 46 mm (L=68 mm); 50 mm (L=72mm); CrV 50BV30; 3/4" (19.0 mm) x 620 mm; CrV 6140; 3/4" (19.0 mm); (L=500 mm); CrV 50BV30; 3/4" (19.0 mm) x 100 mm, 3/4" (19.0 mm) x 200 mm; CrV 50BV30

20
PCS

| YATO | Ø | |
|---------|----------------|---|
| YT-1335 | 3/4" (19.0 mm) | 1 |

GB Star bit sockets
D Aufsteckschlüssel
PL Klucze trzpieniowe
RUS Набор головок-вставок
CZ Čepové klíče

H Csapkulcs
RO Chei cu cozi
E Llaves de mandril
CN 星型旋具套筒

AISI S2
CrV 6150

SLIDING
CARD



1/4"
6.3mm
DIN
3120
AISI
S2
HRC
58-62

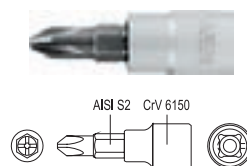
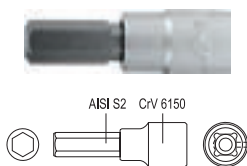
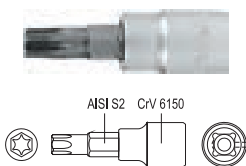

| YATO | Ø | ☆ | L (mm) | torque / moment obrotowy max. (Nm) | ☐ |
|---------|---------------|-----|--------|------------------------------------|--------|
| YT-7660 | 1/4" (6.3 mm) | T8 | 37 | 3.9 | 10/100 |
| YT-7661 | 1/4" (6.3 mm) | T10 | 37 | 5.9 | 10/100 |
| YT-7662 | 1/4" (6.3 mm) | T15 | 37 | 9.8 | 10/100 |
| YT-7663 | 1/4" (6.3 mm) | T20 | 37 | 18.6 | 10/100 |
| YT-7664 | 1/4" (6.3 mm) | T25 | 37 | 26.5 | 10/100 |
| YT-7665 | 1/4" (6.3 mm) | T30 | 37 | 42.9 | 10/100 |
| YT-7666 | 1/4" (6.3 mm) | T40 | 37 | 75.8 | 10/100 |

| YATO | Ø | ⬡ | L (mm) | torque / moment obrotowy max. (Nm) | ☐ |
|---------|---------------|---|--------|------------------------------------|--------|
| YT-7667 | 1/4" (6.3 mm) | 3 | 37 | 14.7 | 10/100 |
| YT-7668 | 1/4" (6.3 mm) | 4 | 37 | 26.5 | 10/100 |
| YT-7669 | 1/4" (6.3 mm) | 5 | 37 | 53.8 | 10/100 |
| YT-7670 | 1/4" (6.3 mm) | 6 | 37 | 88.6 | 10/100 |
| YT-7671 | 1/4" (6.3 mm) | 7 | 37 | 120.6 | 10/100 |
| YT-7672 | 1/4" (6.3 mm) | 8 | 37 | 170.2 | 10/100 |

| YATO | Ø | ⊕ | L (mm) | torque / moment obrotowy max. (Nm) | ☐ |
|---------|---------------|-----|--------|------------------------------------|--------|
| YT-7673 | 1/4" (6.3 mm) | PH1 | 37 | 7.6 | 10/100 |
| YT-7674 | 1/4" (6.3 mm) | PH2 | 37 | 21.6 | 10/100 |
| YT-7675 | 1/4" (6.3 mm) | PH3 | 37 | 44.4 | 10/100 |

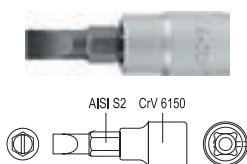
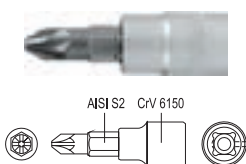

| YATO | Ø | ⊕ | L (mm) | torque / moment obrotowy max. (Nm) | ☐ |
|---------|---------------|-----|--------|------------------------------------|--------|
| YT-7676 | 1/4" (6.3 mm) | PZ1 | 37 | 6.2 | 10/100 |
| YT-7677 | 1/4" (6.3 mm) | PZ2 | 37 | 20.1 | 10/100 |
| YT-7678 | 1/4" (6.3 mm) | PZ3 | 37 | 44.1 | 10/100 |

| YATO | Ø | ⊖ | L (mm) | torque / moment obrotowy max. (Nm) | ☐ |
|---------|---------------|-----|--------|------------------------------------|--------|
| YT-7679 | 1/4" (6.3 mm) | 4.0 | 37 | 5.2 | 10/100 |
| YT-7680 | 1/4" (6.3 mm) | 5.5 | 37 | 8.8 | 10/100 |
| YT-7681 | 1/4" (6.3 mm) | 6.5 | 37 | 16.8 | 10/100 |

GB Star bit sockets
D Aufsteckschlüssel
PL Klucze trzpieniowe
RUS Набор головок-вставок
CZ Čepové klíče

H Csapkulcs
RO Chei cu cozi
E Llaves de mandril
CN 星型旋具套筒

AISI S2
CrV 6150

SLIDING
CARD

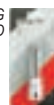

3/8"
10mm
DIN
3120
AISI
S2
HRC
58-62

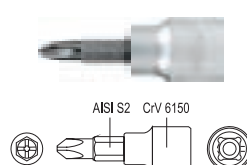
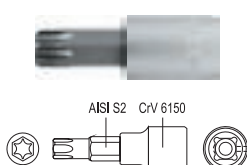
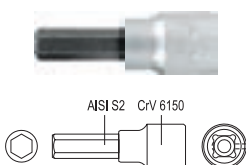

| YATO | Ø | ⬡ | L (mm) | torque / moment obrotowy max. (Nm) | ☐ |
|---------|---------------|----|--------|------------------------------------|--------|
| YT-7693 | 3/8" (9.5 mm) | 3 | 50 | 14.2 | 10/100 |
| YT-7694 | 3/8" (9.5 mm) | 4 | 50 | 27.0 | 10/100 |
| YT-7695 | 3/8" (9.5 mm) | 5 | 50 | 53.9 | 10/100 |
| YT-7696 | 3/8" (9.5 mm) | 6 | 50 | 89.2 | 10/100 |
| YT-7697 | 3/8" (9.5 mm) | 7 | 50 | 122.4 | 10/100 |
| YT-7698 | 3/8" (9.5 mm) | 8 | 50 | 174.5 | 10/100 |
| YT-7699 | 3/8" (9.5 mm) | 10 | 50 | 220.0 | 10/100 |

| YATO | Ø | ☆ | L (mm) | torque / moment obrotowy max. (Nm) | ☐ |
|---------|---------------|-----|--------|------------------------------------|--------|
| YT-7682 | 3/8" (9.5 mm) | T10 | 50 | 6.1 | 10/100 |
| YT-7683 | 3/8" (9.5 mm) | T15 | 50 | 11.0 | 10/100 |
| YT-7684 | 3/8" (9.5 mm) | T20 | 50 | 18.1 | 10/100 |
| YT-7685 | 3/8" (9.5 mm) | T25 | 50 | 27.0 | 10/100 |
| YT-7686 | 3/8" (9.5 mm) | T27 | 50 | 34.8 | 10/100 |
| YT-7687 | 3/8" (9.5 mm) | T30 | 50 | 41.8 | 10/100 |
| YT-7688 | 3/8" (9.5 mm) | T40 | 50 | 77.9 | 10/100 |
| YT-7689 | 3/8" (9.5 mm) | T45 | 50 | 120.6 | 10/100 |
| YT-7690 | 3/8" (9.5 mm) | T50 | 50 | 175.5 | 10/100 |
| YT-7691 | 3/8" (9.5 mm) | T55 | 50 | 205.9 | 10/100 |
| YT-7692 | 3/8" (9.5 mm) | T60 | 50 | 379.0 | 10/100 |

| YATO | Ø | ⊕ | L (mm) | torque / moment obrotowy max. (Nm) | ☐ |
|---------|---------------|-----|--------|------------------------------------|--------|
| YT-7700 | 3/8" (9.5 mm) | PH1 | 50 | 7.4 | 10/100 |
| YT-7701 | 3/8" (9.5 mm) | PH2 | 50 | 22.1 | 10/100 |
| YT-7702 | 3/8" (9.5 mm) | PH3 | 50 | 45.1 | 10/100 |

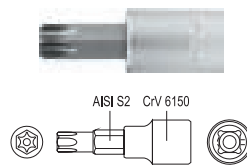
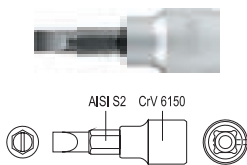
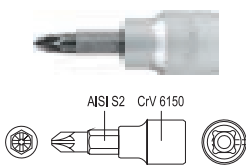

| YATO | Ø | ⊕ | L (mm) | torque / moment obrotowy max. (Nm) | ☐ |
|---------|---------------|-----|--------|------------------------------------|--------|
| YT-7703 | 3/8" (9.5 mm) | PZ1 | 50 | 5.9 | 10/100 |
| YT-7704 | 3/8" (9.5 mm) | PZ2 | 50 | 19.2 | 10/100 |
| YT-7705 | 3/8" (9.5 mm) | PZ3 | 50 | 43.9 | 10/100 |

| YATO | Ø | ⊖ | L (mm) | torque / moment obrotowy max. (Nm) | ☐ |
|---------|---------------|-----|--------|------------------------------------|--------|
| YT-7706 | 3/8" (9.5 mm) | 5.5 | 50 | 9.0 | 10/100 |
| YT-7707 | 3/8" (9.5 mm) | 6.5 | 50 | 17.2 | 10/100 |
| YT-7708 | 3/8" (9.5 mm) | 8.0 | 50 | 20.1 | 10/100 |

| YATO | Ø | ⬡ | L (mm) | torque / moment obrotowy max. (Nm) | ☐ |
|---------|---------------|-----|--------|------------------------------------|--------|
| YT-7709 | 3/8" (9.5 mm) | T45 | 50 | 122.5 | 10/100 |
| YT-7710 | 3/8" (9.5 mm) | T50 | 50 | 176.5 | 10/100 |
| YT-7711 | 3/8" (9.5 mm) | T55 | 50 | 218.0 | 10/100 |
| YT-7712 | 3/8" (9.5 mm) | T60 | 50 | 379.0 | 10/100 |

GB Star bit sockets
 D Aufsteckschlüssel
 PL Klucze trzpieniowe
 RUS Набор головок-вставок
 CZ Čepové klíče

H Csapkulcs
 RO Chei cu cozi
 E Llaves de mandril
 CN 星型旋具套筒

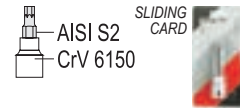

1/2"
 12.5mm
 AISI S2
 DIN 3120
 HRC 58-62

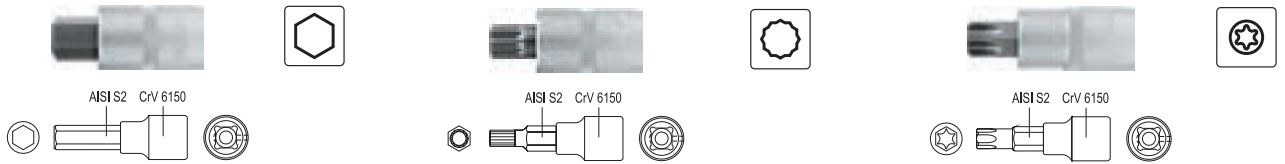

| YATO | Ø | ⬡ L (mm) | torque / moment obrotowy max. (Nm) | 📦 |
|---------|----------------|----------|------------------------------------|--------|
| YT-7723 | 1/2" (12.7 mm) | 4 50 | 26.3 | 10/100 |
| YT-7724 | 1/2" (12.7 mm) | 5 50 | 52.7 | 10/100 |
| YT-7725 | 1/2" (12.7 mm) | 6 50 | 89.0 | 10/100 |
| YT-7726 | 1/2" (12.7 mm) | 7 50 | 128.7 | 10/100 |
| YT-7727 | 1/2" (12.7 mm) | 8 50 | 174.1 | 10/100 |
| YT-7728 | 1/2" (12.7 mm) | 10 50 | 220.0 | 10/100 |
| YT-7729 | 1/2" (12.7 mm) | 12 50 | 370.0 | 10/100 |
| YT-7730 | 1/2" (12.7 mm) | 14 50 | 590.0 | 10/100 |
| YT-7731 | 1/2" (12.7 mm) | 17 50 | 1000.0 | 10/100 |

| YATO | Ø | ⬡ L (mm) | torque / moment obrotowy max. (Nm) | 📦 |
|---------|----------------|----------|------------------------------------|--------|
| YT-7732 | 1/2" (12.7 mm) | M5 50 | 33.9 | 10/100 |
| YT-7733 | 1/2" (12.7 mm) | M6 50 | 60.8 | 10/100 |
| YT-7734 | 1/2" (12.7 mm) | M8 50 | 104.2 | 10/100 |
| YT-7735 | 1/2" (12.7 mm) | M10 50 | 176.5 | 10/100 |
| YT-7736 | 1/2" (12.7 mm) | M12 50 | 220.0 | 10/100 |
| YT-7737 | 1/2" (12.7 mm) | M14 50 | 370.0 | 10/100 |
| YT-7738 | 1/2" (12.7 mm) | M16 50 | 590.0 | 10/100 |

| YATO | Ø | ⬡ L (mm) | torque / moment obrotowy max. (Nm) | 📦 |
|---------|----------------|----------|------------------------------------|--------|
| YT-7713 | 1/2" (12.7 mm) | T20 50 | 17.9 | 10/100 |
| YT-7714 | 1/2" (12.7 mm) | T25 50 | 25.5 | 10/100 |
| YT-7715 | 1/2" (12.7 mm) | T27 50 | 34.1 | 10/100 |
| YT-7716 | 1/2" (12.7 mm) | T30 50 | 42.6 | 10/100 |
| YT-7717 | 1/2" (12.7 mm) | T40 50 | 76.7 | 10/100 |
| YT-7718 | 1/2" (12.7 mm) | T45 50 | 117.0 | 10/100 |
| YT-7719 | 1/2" (12.7 mm) | T50 50 | 176.5 | 10/100 |
| YT-7720 | 1/2" (12.7 mm) | T55 50 | 218.0 | 10/100 |
| YT-7721 | 1/2" (12.7 mm) | T60 50 | 379.0 | 10/100 |
| YT-7722 | 1/2" (12.7 mm) | T70 50 | 590.0 | 10/100 |

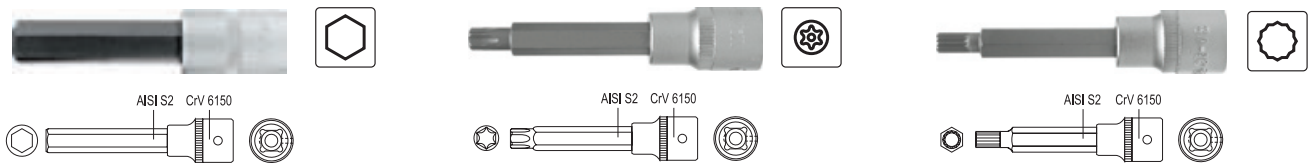

| YATO | Ø | ⬡ L (mm) | torque / moment obrotowy max. (Nm) | 📦 |
|---------|----------------|----------|------------------------------------|--------|
| YT-7739 | 1/2" (12.7 mm) | 4 50 | 27.5 | 10/100 |
| YT-7740 | 1/2" (12.7 mm) | 5 50 | 53.4 | 10/100 |
| YT-7741 | 1/2" (12.7 mm) | 6 50 | 89.4 | 10/100 |
| YT-7742 | 1/2" (12.7 mm) | 7 50 | 132.2 | 10/100 |
| YT-7743 | 1/2" (12.7 mm) | 8 50 | 176.3 | 10/100 |
| YT-7744 | 1/2" (12.7 mm) | 10 50 | 220.0 | 10/100 |
| YT-7745 | 1/2" (12.7 mm) | 12 50 | 370.0 | 10/100 |
| YT-7746 | 1/2" (12.7 mm) | 14 50 | 590.0 | 10/100 |
| YT-7747 | 1/2" (12.7 mm) | 17 50 | 1000.0 | 10/100 |

| YATO | Ø | ⬡ L (mm) | torque / moment obrotowy max. (Nm) | 📦 |
|---------|----------------|----------|------------------------------------|--------|
| YT-0434 | 1/2" (12.7 mm) | T20 100 | 12.7 | 10/100 |
| YT-0441 | 1/2" (12.7 mm) | T25 100 | 19.0 | 10/100 |
| YT-0435 | 1/2" (12.7 mm) | T27 100 | 26.9 | 10/100 |
| YT-0442 | 1/2" (12.7 mm) | T30 100 | 37.4 | 10/100 |
| YT-0436 | 1/2" (12.7 mm) | T40 100 | 65.1 | 10/100 |
| YT-0437 | 1/2" (12.7 mm) | T45 100 | 104.0 | 10/100 |
| YT-0443 | 1/2" (12.7 mm) | T50 100 | 159.0 | 10/100 |
| YT-0438 | 1/2" (12.7 mm) | T55 100 | 257.0 | 10/100 |
| YT-0439 | 1/2" (12.7 mm) | T60 100 | 446.0 | 10/100 |
| YT-0440 | 1/2" (12.7 mm) | T70 100 | 701.0 | 10/100 |

| YATO | Ø | ⬡ L (mm) | torque / moment obrotowy max. (Nm) | 📦 |
|---------|----------------|----------|------------------------------------|--------|
| YT-0450 | 1/2" (12.7 mm) | M5 100 | 16.0 | 10/100 |
| YT-0451 | 1/2" (12.7 mm) | M6 100 | 30.0 | 10/100 |
| YT-0452 | 1/2" (12.7 mm) | M8 100 | 52.0 | 10/100 |
| YT-0453 | 1/2" (12.7 mm) | M10 100 | 120.0 | 10/100 |
| YT-0454 | 1/2" (12.7 mm) | M12 100 | 220.0 | 10/100 |
| YT-0455 | 1/2" (12.7 mm) | M14 100 | 370.0 | 10/100 |
| YT-0456 | 1/2" (12.7 mm) | M16 100 | 590.0 | 10/100 |
| YT-0457 | 1/2" (12.7 mm) | M17 100 | 590.0 | 10/100 |

GB Star bit sockets
 D Aufsteckschlüssel
 PL Klucze trzpieniowe
 RUS Набор головок-вставок
 CZ Čepové klíče

H Csapkulcs
 RO Chei cu cozi
 E Llaves de mandril
 CN 星型旋具套筒组套



21.8Nm max.
 DIN 3120
 AISI S2
 HRC 58-62

7 PCS
 TORX SPECIAL TAMPERPROOF
 TOYOTA VW

12 PCS
 TORX

12 PCS
 TORX TAMPERPROOF



1/4" (6.3 mm): L=35 mm; TS10, TS15, TS20, TS25, TS27, TS30, TS40

| YATO | 📦 |
|---------|-------|
| YT-0461 | 12/48 |



1/4" (6.3 mm): L=35 mm; T8, T10, T15, T20, T25, T27, T30
 3/8" (9.5 mm): L=50 mm; T40, T45, T47, T50, T55

| YATO | 📦 |
|---------|------|
| YT-0430 | 6/48 |



1/4" (6.3 mm): L=35 mm; T8, T10, T15, T20, T25, T27, T30
 3/8" (9.5 mm): L=50 mm; T40, T45, T47, T50, T55

| YATO | 📦 |
|---------|------|
| YT-0431 | 6/48 |

9 PCS
 HEX

5 PCS
 SPLINE



1/4" (6.3 mm): L=35 mm; H2, H3, H4, H5, H6
 3/8" (9.5 mm): L=50 mm; H7, H8, H10, H12

| YATO | 📦 |
|---------|------|
| YT-0432 | 6/36 |



1/4" (6.3 mm): L=35 mm; M5, M6
 3/8" (9.5 mm): L=50 mm; M8, M10, M12

| YATO | 📦 |
|---------|-------|
| YT-0433 | 12/48 |

GB Bit socket set
D Aufsteckschlüssel-Satz
PL Zestaw kluczy trzpieniowych

RUS Набор головок-вставок
CZ Čepové klíče
H Csapkulcs

RO Chei cu cozi
E Juego de llaves de mandril
CN 套筒批头组套

BMC
& COLOR
SLEEVE



| | | |
|-----------|----------------|---------------|
| 18 PCS | 1/2" 12.5mm | 1/4" 6.3mm |
| | CrV 6150 | HRC 58-62 |
| | AISI S2 | DIN 3120 |



- 1/4" (6.3 mm): 4, 5.5, 6.5 mm (L=37 mm); AISI S2 / CrV 6150;
- 1/4" (6.3 mm): PH1, PH2, PH3 (L=37 mm); AISI S2 / CrV 6150;
- 1/2" (12.7 mm): M5, M6, M8, M10, M12, M14 (L=50 mm);
M5, M6, M8, M10, M12, M14 (L=100 mm); AISI S2 / CrV 6150

| YATO | 1/2" (12.7 mm) | 1/4" (6.3 mm) | 10 |
|---------|----------------|---------------|----|
| YT-7750 | | | |



- 1/2" (12.7 mm): T30, T40, T45, T50, T55, T60 (L=50 mm);
T30, T40, T45, T50, T55, T60 (L=100 mm); AISI S2 / CrV 6150;
- 1/4" (6.3 mm): T10, T15, T20, T25, T30, T40 (L=37 mm); AISI S2 / CrV 6150

| YATO | 1/2" (12.7 mm) | 1/4" (6.3 mm) | 10 |
|---------|----------------|---------------|----|
| YT-7751 | | | |



- 1/2" (12.7 mm): 5, 6, 7, 8, 10, 12 mm (L=50 mm);
5, 6, 7, 8, 10, 12 mm (L=100 mm); AISI S2 / CrV 6150;
- 1/4" (6.3 mm): 3, 4, 5, 6, 7, 8 mm (L=37 mm); AISI S2 / CrV 6150

| YATO | 1/2" (12.7 mm) | 1/4" (6.3 mm) | 10 |
|---------|----------------|---------------|----|
| YT-7752 | | | |

GB Bit socket set
D Aufsteckschlüssel-Satz
PL Zestaw kluczy trzpieniowych

RUS Набор головок-вставок
CZ Čepové klíče
H Csapkulcs

RO Chei cu cozi
E Juego de llaves de mandril
CN 花型套筒批头组套

BMC
& COLOR
SLEEVE



| | | |
|-----------|----------------|-------------|
| 12 PCS | 1/2" 12.5mm | CrV 6150 |
| | HRC 58-62 | AISI S2 |
| | DIN 3120 | |



- 1/2" (12.7 mm): M12, M17 (L=50 mm); M6 (L=70 mm); M7, M8 (L=100 mm);
M8, M10 (L=120 mm); M6, M10, M12 (L=140 mm); M5 (L=180 mm);
M6 (L=250 mm); AISI S2 / CrV 6150

| YATO | 1/2" (12.7 mm) | 10 |
|---------|----------------|----|
| YT-7753 | | |

3

**Impact sockets,
accessories & sets**

**Udarowe klucze nasadowe,
akcesoria i zestawy**



| | | |
|--|---|-------|
| Impact sockets 1/2" Klucze nasadowe udarowe 1/2" |  | 70-71 |
|--|---|-------|

| | |
|---|----|
| Impact sockets & sets Klucze nasadowe udarowe i zestawy, krótkie..... | 70 |
| Impact sockets, CrV Klucze nasadowe udarowe, krótkie, CrV..... | 70 |
| Deep impact sockets & sets Klucze nasadowe udarowe i zestawy, długie..... | 71 |
| Deep non-slip impact sockets Udarowe nasadki „Non-slip”, długie..... | 71 |

| | | |
|--|---|----|
| Impact accessories 1/2" Akcesoria udarowe 1/2" |  | 72 |
|--|---|----|

| | |
|---|----|
| Impact extension bars Przedłużki udarowe..... | 72 |
| Impact adapters Redukcje udarowe..... | 72 |
| Impact universal joints Przeguby kuliste udarowe..... | 72 |

| | | |
|--|---|-------|
| Impact sockets 3/4" Udarowe klucze nasadowe 3/4" |  | 73-74 |
|--|---|-------|

| | |
|---|----|
| Impact sockets & sets Klucze nasadowe udarowe i zestawy, krótkie..... | 73 |
| Deep impact sockets & sets Klucze nasadowe udarowe i zestawy, długie..... | 73 |

| | | |
|--|---|----|
| Impact accessories 3/4" Akcesoria udarowe 3/4" |  | 74 |
|--|---|----|

| | |
|---|----|
| Impact extension bars Przedłużki udarowe..... | 74 |
| Impact adapters Redukcje udarowe..... | 74 |
| Impact universal joints Przeguby kuliste udarowe..... | 74 |

| | | |
|--|---|----|
| Impact sockets 1" Udarowe klucze nasadowe 1" |  | 75 |
|--|---|----|

| | |
|--|----|
| Impact sockets Klucze nasadowe udarowe, krótkie..... | 75 |
| Deep impact sockets Klucze nasadowe udarowe, długie..... | 75 |

| | | |
|--|---|----|
| Impact accessories 1" Akcesoria udarowe 1" |  | 75 |
|--|---|----|

| | |
|---|----|
| Impact extension bars with adapter Przedłużki udarowe z redukcją..... | 75 |
|---|----|

| | | |
|--|---|----|
| Impact sockets for front hub nuts Nasadki udarowe do piast |  | 76 |
|--|---|----|

| | | |
|---|---|----|
| Impact bit socket sets 1/2" Zestawy udarowych kluczy trzpieniowych 1/2" |  | 76 |
|---|---|----|

| | | |
|---|--|----|
| Spline impact bit sets 3/4" Zestawy bitów udarowych „Spline” 3/4" |  | 76 |
|---|--|----|

- GB Hexagonal impact socket
- D Kraftschrauber-Einsatz
- PL Nasadka udarowa sześciokątna
- RUS Головка ударная 6-гранная
- CZ Šestihranný nástavec
- H Hatszögű rátét
- RO Cheie tubulară hexagonală de impact
- E Boquilla de percusión
- CN 六角风动套筒

COLOR BOX



1/2"
12.5mm

CrMo
SCM-440

AS-DRIVE

3

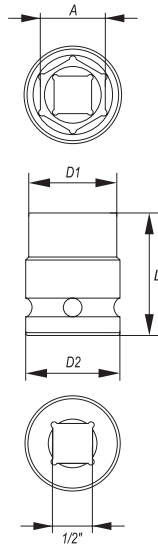

| YATO | ∅ A (mm) | D1 (mm) | D2 (mm) | L (mm) | PCS packing | |
|---------|----------|---------|---------|--------|-------------|-----|
| YT-1000 | 10 | 17.5 | 25.0 | 39 | 60 | 240 |
| YT-1001 | 11 | 18.5 | 25.0 | 39 | 60 | 240 |
| YT-1002 | 12 | 20.0 | 25.0 | 39 | 60 | 240 |
| YT-1003 | 13 | 21.0 | 25.0 | 39 | 60 | 240 |
| YT-1004 | 14 | 22.5 | 25.0 | 39 | 60 | 240 |
| YT-1005 | 15 | 23.5 | 30.0 | 39 | 40 | 160 |
| YT-1006 | 16 | 24.0 | 30.0 | 39 | 40 | 160 |
| YT-1007 | 17 | 26.0 | 30.0 | 39 | 40 | 160 |
| YT-1008 | 18 | 27.5 | 30.0 | 39 | 40 | 160 |
| YT-1009 | 19 | 28.0 | 30.0 | 39 | 40 | 160 |
| YT-1010 | 20 | 30.0 | 30.0 | 39 | 40 | 160 |
| YT-1011 | 21 | 30.0 | 30.0 | 39 | 40 | 160 |
| YT-1012 | 22 | 32.0 | 30.0 | 39 | 30 | 120 |
| YT-1013 | 23 | 32.0 | 30.0 | 39 | 30 | 120 |
| YT-1014 | 24 | 34.0 | 30.0 | 43 | 30 | 120 |
| YT-1015 | 25 | 35.0 | 30.0 | 43 | 30 | 120 |
| YT-1016 | 26 | 38.0 | 30.0 | 43 | 24 | 96 |
| YT-1017 | 27 | 38.0 | 30.0 | 43 | 24 | 96 |
| YT-1018 | 28 | 40.0 | 30.0 | 48 | 24 | 96 |
| YT-1019 | 29 | 41.0 | 30.0 | 48 | 22 | 88 |
| YT-1020 | 30 | 42.0 | 30.0 | 48 | 24 | 96 |
| YT-1022 | 32 | 44.0 | 30.0 | 48 | 20 | 80 |

- GB Impact socket set
- D Kraftschrauber-Einsätze
- PL Zestaw nasadek udarowych
- RUS Набор торцевых ударных головок
- CZ Sada nástrčných klíčů pro úderové utahováky

- H Dugófej készlet ütvebehajtóhoz
- RO Set chei tubulare pt. impact
- E Juego de boquillas de percusión cortas
- CN 风动套筒组套



10
PCS

1/2"
12.5mm

CrMo
SCM-440

AS-DRIVE

METAL CASE & COLOR BOX



1/2" (12.7 mm): 10, 12, 13, 14, 15, 16, 17, 18, 19, 22 mm; L=39 mm

| YATO | ∅ | |
|---------|----------------|----|
| YT-1025 | 1/2" (12.7 mm) | 20 |

- GB Hexagonal impact socket
- D Kraftschrauber-Einsatz
- PL Nasadka udarowa sześciokątna
- RUS Головка ударная 6-гранная
- CZ Šestihranný nástavec
- H Hatszögű rátét
- RO Cheie tubulară hexagonală de impact
- E Boquilla de percusión
- CN 六角风动套筒

COLOR BOX



1/2"
12.5mm

CrV

AS-DRIVE

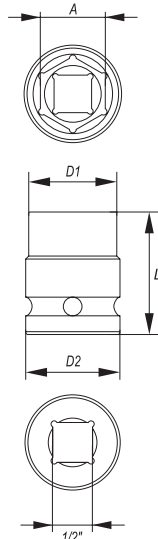

| YATO | ∅ A (mm) | D1 (mm) | D2 (mm) | L (mm) | PCS packing | |
|---------|----------|---------|---------|--------|-------------|-----|
| YT-1781 | 9 | 15.5 | 24.0 | 38 | 12 | 240 |
| YT-1782 | 10 | 17.0 | 24.0 | 38 | 12 | 240 |
| YT-1784 | 12 | 19.0 | 24.0 | 38 | 12 | 240 |
| YT-1787 | 15 | 24.0 | 24.0 | 38 | 12 | 240 |
| YT-1792 | 20 | 30.0 | 30.0 | 38 | 12 | 144 |
| YT-1794 | 22 | 32.0 | 32.0 | 38 | 12 | 96 |
| YT-1795 | 23 | 34.0 | 34.0 | 40 | 12 | 96 |
| YT-1797 | 27 | 37.5 | 37.5 | 41 | 10 | 80 |
| YT-1799 | 32 | 44.0 | 44.0 | 44 | 10 | 80 |

- GB Hexagonal deep impact socket
D Kraftschrauber-Einsatz, lang
PL Nasadka udarowa sześciokątna długa
RUS Головка ударная 6-гранная глубокая
CZ Šestihranný hluboký nástavec
H Hatszögű rátét mély
RO Cheie tubulară hexagonală de impact adâncă
E Boquilla de percusión profunda
CN 六角风动长套筒

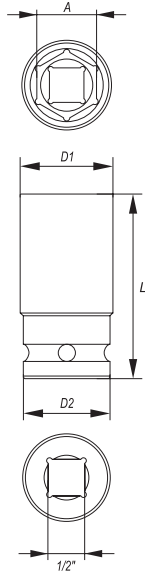

COLOR BOX



1/2"
12.5mm

CrMo
SCM-440

AS-DRIVE

| YATO | ∅ A (mm) | D1 (mm) | D2 (mm) | L (mm) | PCS packing: | |
|---------|----------|---------|---------|--------|--------------|-----|
| YT-1030 | 10 | 17.5 | 24.0 | 78 | 30 | 120 |
| YT-1031 | 11 | 18.5 | 24.0 | 78 | 30 | 120 |
| YT-1032 | 12 | 20.0 | 24.0 | 78 | 30 | 120 |
| YT-1033 | 13 | 21.0 | 24.0 | 78 | 30 | 120 |
| YT-1034 | 14 | 22.0 | 24.0 | 78 | 30 | 120 |
| YT-1035 | 15 | 23.7 | 24.0 | 78 | 30 | 120 |
| YT-1036 | 16 | 24.0 | 24.0 | 78 | 30 | 120 |
| YT-1037 | 17 | 26.0 | 26.0 | 78 | 25 | 100 |
| YT-1038 | 18 | 28.0 | 28.0 | 78 | 24 | 96 |
| YT-1039 | 19 | 28.0 | 28.0 | 78 | 24 | 96 |
| YT-1040 | 20 | 30.0 | 30.0 | 78 | 20 | 80 |
| YT-1041 | 21 | 30.0 | 30.0 | 78 | 20 | 80 |
| YT-1042 | 22 | 32.0 | 30.0 | 78 | 18 | 72 |
| YT-1043 | 23 | 32.0 | 30.0 | 78 | 15 | 60 |
| YT-1044 | 24 | 34.0 | 30.0 | 78 | 15 | 60 |
| YT-1045 | 25 | 35.0 | 30.0 | 78 | 15 | 60 |
| YT-1046 | 26 | 38.0 | 30.0 | 78 | 12 | 48 |
| YT-1047 | 27 | 38.0 | 30.0 | 78 | 12 | 48 |
| YT-1048 | 28 | 40.0 | 30.0 | 78 | 12 | 48 |
| YT-1049 | 29 | 41.0 | 30.0 | 78 | 10 | 40 |
| YT-1050 | 30 | 42.0 | 30.0 | 78 | 10 | 40 |
| YT-1052 | 32 | 44.0 | 30.0 | 78 | 10 | 40 |

3

- GB Impact socket set
D Kraftschrauber-Einsätze
PL Zestaw nasadek udarowych
RUS Набор торцевых ударных головок
CZ Sada nástrčných klíčů pro úderové utahováky

- H Dugófej készlet ütvebehajtóhoz
RO Set chei tubulare pt. impact
E Juego de boquillas de percusión cortas
CN 风动长套筒组套

METAL CASE & COLOR BOX



1/2"
12.5mm

CrMo
SCM-440

AS-DRIVE



11
PCS

1/2" (12.7 mm): 10, 12, 13, 14, 15, 16, 17, 18, 19, 22, 24 mm; L=78 mm

15
PCS

1/2" (12.7 mm): 10, 12, 13, 14, 15, 16, 17, 18, 19, 21, 22, 24, 27, 30, 32 mm; L=78 mm

| YATO | ∅ | |
|---------|----------------|----|
| YT-1054 | 1/2" (12.7 mm) | 10 |

| YATO | ∅ | |
|---------|----------------|---|
| YT-1055 | 1/2" (12.7 mm) | 4 |

- GB Hexagonal deep impact socket NON-SLIP
D Kraftschrauber-Einsatz, lang NON-SLIP
PL Nasadka udarowa sześciokątna długa NON-SLIP
RUS Головка ударная 6-гранная глубокая NON-SLIP
CZ Šestihranný hluboký nástavec NON-SLIP
H Hatszögű rátét mély NON-SLIP
RO Cheie tubulară hexagonală de impact adâncă NON-SLIP
E Boquilla de percusión profunda NON-SLIP
CN 风动防滑长套筒

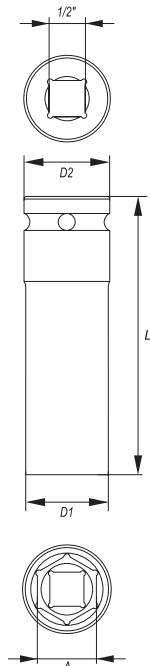

PLASTIC HANGER



10 PCS

COLOR BOX



1/2"
12.5mm

CrMo
SCM-440

NON-SLIP SYSTEM

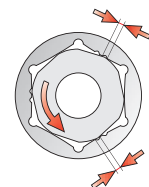

| YATO | ∅ A (mm) | D1 (mm) | D2 (mm) | L (mm) | PCS packing: | |
|---------|----------|---------|---------|--------|--------------|-----|
| YT-1588 | 10 | 12.40 | 19.55 | 80 | 10 | 160 |
| YT-1589 | 11 | 18.90 | 19.60 | 80 | 10 | 160 |
| YT-1590 | 12 | 19.90 | 24.62 | 80 | 10 | 160 |
| YT-1591 | 13 | 20.95 | 24.70 | 80 | 10 | 160 |
| YT-1592 | 14 | 22.88 | 24.74 | 80 | 10 | 160 |
| YT-1593 | 15 | 23.85 | 24.63 | 80 | 10 | 120 |
| YT-1594 | 16 | 24.64 | 24.64 | 80 | 10 | 120 |
| YT-1596 | 18 | 27.90 | 29.78 | 80 | 10 | 100 |
| YT-1598 | 21 | 31.70 | 29.90 | 80 | 10 | 80 |
| YT-1599 | 24 | 34.75 | 30.10 | 80 | 10 | 80 |

71

GB Impact extension bar
 D Verlängerung
 PL Przedłużka udarowa
 RUS Удлинитель ударный
 CZ Prodlužovací přípravek
 H Toldalék
 RO Prelungitor
 E Tubo de prolongación
 CN 风动接杆

1/2" CrMo
 12.5mm SCM-440



COLOR BOX



| YATO | Ø | D1 (mm) | D2 (mm) | L (mm) | PCS packing | |
|---------|----------------|---------|---------|--------|-------------|-----|
| YT-1060 | 1/2" (12.7 mm) | 17.5 | 25.0 | 75 | 40 | 160 |
| YT-1061 | 1/2" (12.7 mm) | 18.5 | 25.0 | 125 | 28 | 112 |
| YT-1062 | 1/2" (12.7 mm) | 20.0 | 25.0 | 250 | 30 | 60 |

GB Impact extension bar
 D Verlängerung
 PL Przedłużka udarowa
 RUS Удлинитель ударный
 CZ Prodlužovací přípravek
 H Toldalék
 RO Prelungitor
 E Tubo de prolongación
 CN 风动接杆

1/2" CrV
 12.5mm

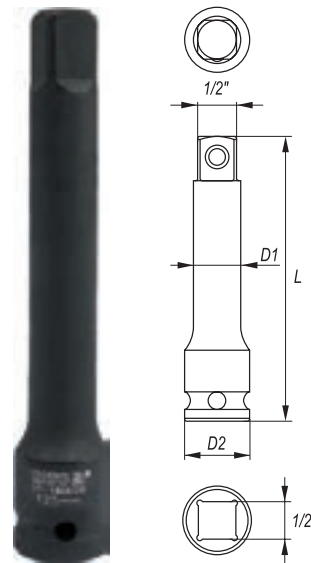

COLOR BOX



| YATO | Ø | D1 (mm) | D2 (mm) | L (mm) | PCS packing | |
|---------|----------------|---------|---------|--------|-------------|-----|
| YT-1807 | 1/2" (12.7 mm) | 16.0 | 23.0 | 75 | 12 | 144 |

GB Impact adapter
 D Reduktion
 PL Redukcja udarowa
 RUS Переходник
 CZ Redukce
 H Redukció
 RO Reducție
 E Reducción
 CN 风动转换头

1/2" CrMo
 12.5mm SCM-440



COLOR BOX



| YATO | Ø | Ø | D (mm) | L (mm) | PCS packing | |
|---------|--------------------|--------------------|--------|--------|-------------|-----|
| YT-1067 | 1/2" (12.7 mm) (F) | 3/4" (19.0 mm) (M) | 30 | 48 | 40 | 160 |

GB Impact universal joint
 D Gelenstück
 PL Przegub kulisty udarowy
 RUS Кардан ударный
 CZ Kloub kulový
 H Univerzális csuklós csatlakozó
 RO Adaptor
 E Articulación redonda
 CN 风动方向接头

1/2" CrMo
 12.5mm SCM-440



COLOR BOX



| YATO | Ø | D1 (mm) | D2 (mm) | L (mm) | PCS packing | |
|---------|----------------|---------|---------|--------|-------------|-----|
| YT-1064 | 1/2" (12.7 mm) | 31 | 17 | 63 | 25 | 100 |

- GB Hexagonal impact socket
D Kraftschrauber-Einsatz
PL Nasadka udarowa sześciokątna
RUS Головка ударная 6-гранная
CZ Sestihranný nástavec
H Hatszögű rátét
RO Cheie tubulară hexagonală de impact
E Boquilla de percusión
CN 六角风动套筒

COLOR BOX



3/4"
19mm

CrMo
SCM-440

AS-DRIVE

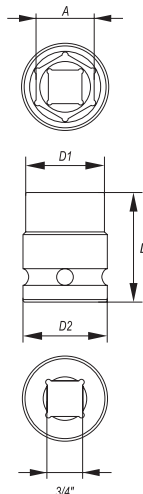

| YATO | ∅ A (mm) | D1 (mm) | D2 (mm) | L (mm) | PCS packing: | |
|---------|----------|---------|---------|--------|--------------|----|
| YT-1070 | 19 | 32 | 40 | 50 | 16 | 64 |
| YT-1071 | 21 | 35 | 40 | 50 | 16 | 64 |
| YT-1072 | 22 | 38 | 40 | 50 | 16 | 64 |
| YT-1073 | 23 | 38 | 40 | 50 | 16 | 64 |
| YT-1074 | 24 | 40 | 40 | 50 | 16 | 64 |
| YT-1075 | 25 | 40 | 40 | 50 | 16 | 64 |
| YT-1076 | 26 | 40 | 40 | 50 | 16 | 64 |
| YT-1077 | 27 | 42 | 42 | 53 | 16 | 64 |
| YT-1078 | 28 | 44 | 44 | 53 | 16 | 64 |
| YT-1079 | 29 | 46 | 44 | 53 | 12 | 48 |
| YT-1080 | 30 | 46 | 44 | 53 | 12 | 48 |
| YT-1082 | 32 | 48 | 44 | 56 | 12 | 48 |
| YT-1083 | 33 | 48 | 44 | 56 | 8 | 32 |
| YT-1084 | 34 | 50 | 44 | 56 | 8 | 32 |
| YT-1085 | 35 | 50 | 44 | 56 | 6 | 24 |
| YT-1086 | 36 | 52 | 44 | 56 | 6 | 24 |
| YT-1088 | 38 | 56 | 44 | 57 | 6 | 24 |
| YT-1091 | 41 | 60 | 44 | 57 | 5 | 20 |
| YT-1092 | 42 | 61 | 44 | 57 | 4 | 16 |
| YT-1093 | 43 | 63 | 44 | 57 | 4 | 16 |
| YT-1096 | 46 | 66 | 44 | 62 | 3 | 12 |
| YT-1098 | 48 | 68 | 44 | 67 | 3 | 12 |
| YT-1100 | 50 | 71 | 54 | 72 | 3 | 12 |
| YT-1102 | 52 | 74 | 54 | 72 | 2 | 8 |
| YT-1105 | 55 | 78 | 54 | 74 | 2 | 8 |
| YT-1110 | 60 | 84 | 54 | 74 | 2 | 8 |

3

- GB Impact socket set
D Kraftschrauber-Einsätze
PL Zestaw nasadek udarowych
RUS Набор торцевых ударных головок
CZ Sada nástrčných klíčů pro úderové utahováky

- H Dugófej készlet ütvebehajtóhoz
RO Set chei tubulare pt. impact
E Juego de boquillas de percusión cortas
CN 风动套筒组套



METAL CASE & COLOR BOX

8
PCS

3/4"
19mm

CrMo
SCM-440

AS-DRIVE



3/4" (19.0 mm): 22, 24 mm (L=50 mm); 27, 30 mm (L=53 mm);
32, 36 mm (L=55 mm); 38, 41 mm (L=57 mm)

| YATO | ∅ | |
|---------|----------------|---|
| YT-1115 | 3/4" (19.0 mm) | 6 |

- GB Hexagonal deep impact socket
D Kraftschrauber-Einsatz, lang
PL Nasadka udarowa sześciokątna długa
RUS Головка ударная 6-гранная глубокая
CZ Sestihranný hluboký nástavec
H Hatszögű rátét mély
RO Cheie tubulară hexagonală de impact adâncă
E Boquilla de percusión profunda
CN 六角风动长套筒

COLOR BOX



3/4"
19mm

CrMo
SCM-440

AS-DRIVE

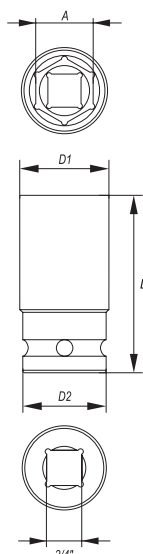

| YATO | ∅ A (mm) | D1 (mm) | D2 (mm) | L (mm) | PCS packing: | |
|---------|----------|---------|---------|--------|--------------|----|
| YT-1119 | 19 | 32 | 44 | 90 | 9 | 36 |
| YT-1121 | 21 | 35 | 44 | 90 | 9 | 36 |
| YT-1122 | 22 | 38 | 44 | 90 | 9 | 36 |
| YT-1123 | 23 | 38 | 44 | 90 | 9 | 36 |
| YT-1124 | 24 | 40 | 44 | 90 | 9 | 36 |
| YT-1125 | 25 | 40 | 44 | 90 | 9 | 36 |
| YT-1126 | 26 | 40 | 44 | 90 | 9 | 36 |
| YT-1127 | 27 | 42 | 44 | 90 | 9 | 36 |
| YT-1128 | 28 | 44 | 44 | 90 | 8 | 32 |
| YT-1129 | 29 | 44 | 44 | 90 | 8 | 32 |
| YT-1130 | 30 | 46 | 44 | 90 | 7 | 28 |
| YT-1132 | 32 | 48 | 44 | 90 | 7 | 28 |
| YT-1133 | 33 | 50 | 44 | 90 | 6 | 24 |
| YT-1134 | 34 | 51 | 44 | 90 | 6 | 24 |
| YT-1135 | 35 | 52 | 44 | 90 | 6 | 24 |
| YT-1136 | 36 | 54 | 44 | 90 | 6 | 24 |
| YT-1138 | 38 | 56 | 44 | 90 | 6 | 24 |
| YT-1141 | 41 | 60 | 44 | 90 | 5 | 20 |
| YT-1142 | 42 | 61 | 44 | 90 | 4 | 16 |
| YT-1143 | 43 | 63 | 44 | 90 | 3 | 12 |
| YT-1146 | 46 | 66 | 44 | 90 | 3 | 12 |
| YT-1148 | 48 | 68 | 44 | 90 | 2 | 8 |
| YT-1150 | 50 | 71 | 54 | 90 | 2 | 8 |

GB Impact socket set
 D Kraftschrauber-Einsätze
 PL Zestaw nasadek uderowych
 RUS Набор торцевых ударных головок
 CZ Sada nástrčných kľučí pro úderové utahováky

H Dugófej készlet ütvebehajtóhoz
 RO Set chei tubulare pt. impact
 E Juego de boquillas de percusión cortas
 CN 风动长套筒组套



8 PCS
 3/4" 19mm
 CrMo SCM-440
 AS-DRIVE

3



3/4" (19.0 mm): 22, 24, 27, 30, 32, 36, 38, 41 mm (L=90 mm)

| YATO | Ø | |
|---------|----------------|---|
| YT-1155 | 3/4" (19.0 mm) | 4 |

GB Impact extension bar
 D Verlängerung
 PL Przedłużka uderowa
 RUS Удлинитель ударный
 CZ Prodlužovací příravek
 H Toldalék
 RO Prelungitor
 E Tubo de prolongación
 CN 风动接杆

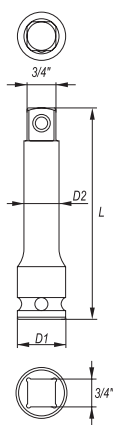

3/4" 19mm
 CrMo SCM-440



| YATO | Ø | D1 (mm) | D2 (mm) | L (mm) | PCS packing: | |
|---------|----------------|---------|---------|--------|--------------|----|
| YT-1160 | 3/4" (19.0 mm) | 44 | 24 | 100 | 8 | 32 |
| YT-1161 | 3/4" (19.0 mm) | 44 | 24 | 175 | 10 | 20 |
| YT-1162 | 3/4" (19.0 mm) | 44 | 24 | 250 | 8 | 16 |
| YT-1163 | 3/4" (19.0 mm) | 44 | 24 | 330 | 6 | 12 |

GB Impact adapter
 D Reduktion
 PL Redukcja uderowa
 RUS Переходник
 CZ Redukce
 H Redukció
 RO Reducție
 E Reducció
 CN 风动转换头

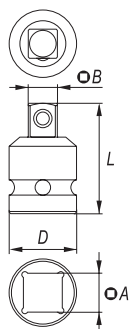

3/4" 19mm
 CrMo SCM-440



| YATO | Ø | Ø | D (mm) | L (mm) | PCS packing: | |
|---------|--------------------|--------------------|--------|--------|--------------|----|
| YT-1167 | 3/4" (19.0 mm) (F) | 1/2" (12.7 mm) (M) | 44 | 56 | 12 | 48 |
| YT-1168 | 3/4" (19.0 mm) (F) | 1" (25.4 mm) (M) | 44 | 63 | 12 | 48 |

GB Impact universal joint
 D Gelenkstück
 PL Przegub kulisty uderowy
 RUS Кардан ударный
 CZ Kloub kulový
 H Univerzális csuklós csatlakozó
 RO Adaptor
 E Articulación redonda
 CN 风动万向接头

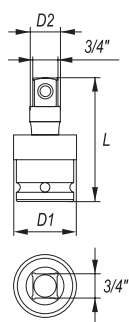

3/4" 19mm
 CrMo SCM-440



| YATO | Ø | D1 (mm) | D2 (mm) | L (mm) | PCS packing: | |
|---------|----------------|---------|---------|--------|--------------|----|
| YT-1164 | 3/4" (19.0 mm) | 31 | 44 | 102 | 8 | 32 |

- GB Hexagonal impact socket
D Kraftschrauber-Einsatz
PL Nasadka udarowa sześciokątna
RUS Головка ударная 6-гранная
CZ Šestihranný nástavec
H Hatszögű rátét
RO Cheie tubulară hexagonală de impact
E Boquilla de percusión
CN 六角风动套筒

COLOR BOX



1"
25 mm

CrMo
SCM-440

AS-DRIVE

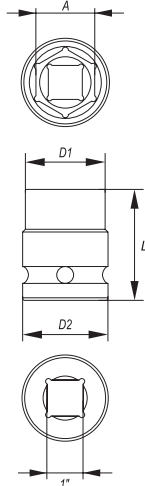

| YATO | ∅ A (mm) | D1 (mm) | D2 (mm) | L (mm) | PCS packing | |
|---------|----------|---------|---------|--------|-------------|----|
| YT-1180 | 24 | 42 | 54 | 59 | 6 | 24 |
| YT-1182 | 26 | 43 | 54 | 59 | 6 | 24 |
| YT-1183 | 27 | 46 | 54 | 59 | 6 | 24 |
| YT-1184 | 28 | 47 | 54 | 59 | 6 | 24 |
| YT-1185 | 29 | 48 | 54 | 60 | 6 | 24 |
| YT-1186 | 30 | 49 | 54 | 60 | 6 | 24 |
| YT-1187 | 32 | 52 | 54 | 61 | 6 | 24 |
| YT-1188 | 33 | 53 | 54 | 61 | 6 | 24 |
| YT-1189 | 34 | 54 | 54 | 61 | 6 | 24 |
| YT-1191 | 36 | 57 | 54 | 65 | 6 | 24 |
| YT-1192 | 37 | 58 | 54 | 65 | 6 | 24 |
| YT-1193 | 38 | 60 | 54 | 65 | 5 | 20 |
| YT-1194 | 41 | 63 | 54 | 65 | 4 | 16 |
| YT-1195 | 43 | 65 | 54 | 68 | 4 | 16 |
| YT-1196 | 46 | 69 | 54 | 73 | 3 | 12 |
| YT-1197 | 48 | 72 | 54 | 73 | 2 | 8 |
| YT-1198 | 50 | 75 | 54 | 73 | 2 | 8 |

- GB Hexagonal deep impact socket
D Kraftschrauber-Einsatz, lang
PL Nasadka udarowa sześciokątna długa
RUS Головка ударная 6-гранная глубокая
CZ Šestihranný hluboký nástavec
H Hatszögű rátét mély
RO Cheie tubulară hexagonală de impact adâncă
E Boquilla de percusión profunda
CN 六角风动长套筒

COLOR BOX



1"
25 mm

CrMo
SCM-440

AS-DRIVE

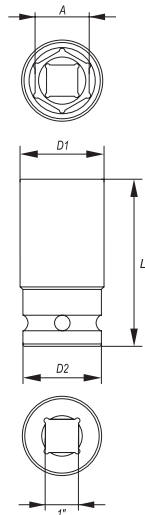

| YATO | ∅ A (mm) | D1 (mm) | D2 (mm) | L (mm) | PCS packing | |
|---------|----------|---------|---------|--------|-------------|----|
| YT-1175 | 27 | 46 | 54 | 90 | 6 | 24 |
| YT-1176 | 30 | 50 | 54 | 90 | 6 | 24 |
| YT-1177 | 32 | 52 | 54 | 90 | 6 | 24 |
| YT-1178 | 33 | 54 | 54 | 90 | 6 | 24 |
| YT-1179 | 36 | 57 | 54 | 90 | 6 | 24 |

- GB Impact extension bar with adapter
D Verlängerung mit Adapter
PL Przedłużka udarowa z redukcją
RUS Удлинитель с редукцией
CZ Prodloužení s redukcí
H Hosszabbító szár adapterrel
RO Bara extensie cu adaptor
E Tubo de prolongación con reductor
CN 风动转换接头

COLOR BOX



1"
25 mm

CrMo
SCM-440

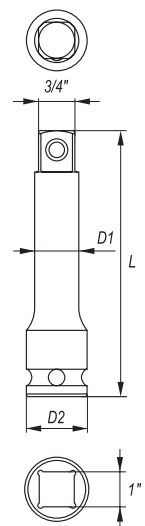

| YATO | ∅ A | ∅ B | D1 (mm) | D2 (mm) | L (mm) | PCS packing | |
|---------|------------------|-------------------|---------|---------|--------|-------------|----|
| YT-1169 | 1" (25.4 mm) (F) | 3/4" (19.0mm) (M) | 53 | 33 | 250 | 6 | 12 |

- GB Hexagonal impact socket
 D Kraftschrauber-Einsatz
 PL Nasadka udarowa sześciokątna
 RUS Головка ударная 6-гранная
 CZ Sestihranný nástavec
 H Hatszögű rátét
 RO Cheie tubulară hexagonală de impact
 E Boquilla de percusión
 CN 六角风动套筒

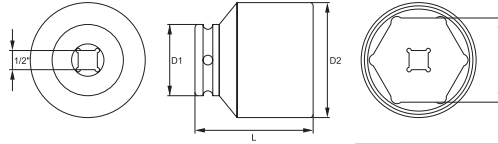

COLOR BOX



1/2"
12.5mm

FOR FRONT HUB NUTS DO PIAST

CrMo SCM-440

AS-DRIVE

| YATO | ∅ A (mm) | D1 (mm) | D2 (mm) | L (mm) | PCS packing: | |
|---------|----------|---------|---------|--------|--------------|----|
| YT-1029 | 52 | 44 | 71 | 72 | 3 | 12 |

- GB Bi-hexagonal impact socket
 D Zwölfkant-Kraftschrauber-Einsatz
 PL Nasadka udarowa dwunastokątna
 RUS Головка ударная 12-гранная
 CZ Vanáctihranný nástavec
 H Dugófej, 12 lapú
 RO Cheie tubulară bihexagonală de impact
 E Boquilla bihexagonal de percusión
 CN 风动套筒

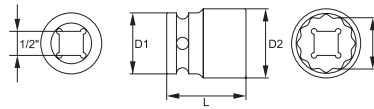

COLOR BOX



1/2"
12.5mm

FOR FRONT HUB NUTS DO PIAST

CrMo SCM-440

AS-DRIVE

| YATO | ∅ A (mm) | D1 (mm) | D2 (mm) | L (mm) | PCS packing: | |
|---------|----------|---------|---------|--------|--------------|-----|
| YT-1027 | 24 | 30 | 34 | 39 | 10 | 120 |

- GB Bi-hexagonal deep impact socket
 D Zwölfkant-Kraftschrauber-Einsatz, lang
 PL Nasadka udarowa dwunastokątna długa
 RUS Головка ударная 12-гранная глубокая
 CZ Vanáctihranný hluboký nástavec
 H Dugófej, mély, 12 lapú
 RO Cheie tubulară bihexagonală de impact adâncă
 E Boquilla bihexagonal de percusión profunda
 CN 风动套筒

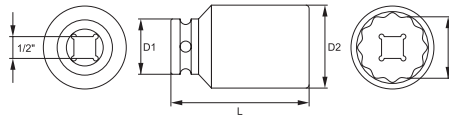

COLOR BOX



1/2"
12.5mm

FOR FRONT HUB NUTS DO PIAST

CrMo SCM-440

AS-DRIVE

| YATO | ∅ A (mm) | D1 (mm) | D2 (mm) | L (mm) | PCS packing: | |
|---------|----------|---------|---------|--------|--------------|----|
| YT-1028 | 33 | 30 | 45 | 75 | 8 | 32 |

- GB Impact bit socket set
 D Schlagsteckschlüsselsatz
 PL Zestaw uderowych kluczy trzpieniowych
 RUS Набор ударных торцовых ключей
 CZ Souprava rázových zástrčných klíčů
 H Üthető dugókulcs bit - készlet
 RO Set chei de șoc cu bolt
 E Juego de llaves de mandril de impacto
 CN 风动套筒批头组套

BMC & COLOR SLEEVE



8 PCS

1/2"
12.5mm

CrMo

HRC 54

T30, T40, T45, T50, T55, T60, T70, T80



6, 7, 8, 10, 12, 14, 17, 19 mm



| YATO | ∅ | |
|---------|----------------|----|
| YT-1065 | 1/2" (12.7 mm) | 15 |

| YATO | ∅ | |
|---------|----------------|----|
| YT-1066 | 1/2" (12.7 mm) | 15 |

RMS, RM6, RM7, RM8, RM10, RM11, RM12, RM13



M5, M6, M8, M10, M12, M14, M16, M18



| YATO | ∅ | |
|---------|----------------|----|
| YT-1068 | 1/2" (12.7 mm) | 15 |

| YATO | ∅ | |
|---------|----------------|----|
| YT-1069 | 1/2" (12.7 mm) | 15 |

- GB Spline impact bit set
 D Schlagwerkzeugsatz - Spline
 PL Zestaw bitów uderowych - Spline
 RUS Набор ударных битов - Spline
 CZ Souprava bitů pro rázové utahováky - Spline
 H Ütő bit készlet - Spline
 RO Set tubulare de impact
 E Juego de las piezas de precisión - Spline
 CN 风动花键批头组套

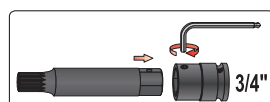

BMC & COLOR BOX



6 PCS

3/4"
19mm

SPLINE (XZN)

CrMo

M12, M14, M16, M18 x 22 mm; (L=107 mm); CrMo;
 3/4" (19.0 mm) x 22 mm; CrMo;



| YATO | ∅ | |
|---------|----------------|---|
| YT-1157 | 3/4" (19.0 mm) | 8 |

Memo

4

Torque wrenches & torque multipliers Klucze dynamometryczne i wzmacniacze momentu



| | | | |
|---|---|--|---|
| <p>Torque wrenches Klucze dynamometryczne</p> <p style="text-align: right;">80</p> |  | <p>Torque angle gauges Kątomierze do dokręcania śrub</p> <p style="text-align: right;">81</p> |  |
| <p>Torque wrenches with metal handle Klucze dynamometryczne z metalową rączką..... 80</p> <p>Torque wrenches with plastic handle Klucze dynamometryczne z plastikową rączką..... 80</p> <p>Digital torque wrenches Klucze dynamometryczne, cyfrowe..... 80</p> | <p>Torque multipliers Wzmacniacze momentu</p> <p style="text-align: right;">81</p> |  | |

GB Torque wrench
 D Drehmomentschlüssel
 PL Klucz dynamometryczny

RUS Ключ динамометрический
 CZ Dynamometrický klíč
 H Nyomatékkulcs

RO Cheie cu dinamometru
 E Llave dinamométrica
 CN 传统型可调式扭力扳手

1/2" 3/8" CrV
 12.5mm 10mm 6140



| YATO | Ø | Nm | L (mm) | Box |
|---------|----------------|--------|--------|-----|
| YT-0750 | 3/8" (9.5 mm) | 19-110 | 366 | 20 |
| YT-0760 | 1/2" (12.7 mm) | 42-210 | 470 | 12 |

GB Torque wrench
 D Drehmomentschlüssel
 PL Klucz dynamometryczny

RUS Ключ динамометрический
 CZ Dynamometrický klíč
 H Nyomatékkulcs

RO Cheie cu dinamometru
 E Llave dinamométrica
 CN 可调式扭力扳手

3/4" 1/2" CrV
 19mm 12.5mm 6140



| YATO | Ø | Nm | L (mm) | Box |
|---------|----------------|---------|--------|-----|
| YT-0761 | 1/2" (12.7 mm) | 40-210 | 535 | 10 |
| YT-0770 | 3/4" (19.0 mm) | 100-500 | 865 | 4 |
| YT-0771 | 3/4" (19.0 mm) | 140-980 | 1230 | 2 |

YT-0771
 • application: automotive service stations, trucks
 • wrench and extension pipe designed to tighten screws in double wheels
 • measurement tolerance +/- 3%

YT-0771
 • przeznaczenie: serwis, samochody ciężarowe
 • łącznie z przedłużką dostosowany do dokręcania śrub w kołach bliźniaczych
 • dokładność pomiarowa +/- 3%

GB Torque wrench
 D Drehmomentschlüssel
 PL Klucz dynamometryczny

RUS Ключ динамометрический
 CZ Dynamometrický klíč
 H Nyomatékkulcs

RO Cheie cu dinamometru
 E Llave dinamométrica
 CN 扭力扳手

1/4" CrV
 6.3mm 6140



| YATO | Ø | Nm | L (mm) | Box |
|---------|---------------|------|--------|-----|
| YT-0751 | 1/4" (6.3 mm) | 2-10 | 281 | 24 |

GB Torque wrench
 D Drehmomentschlüssel
 PL Klucz dynamometryczny

RUS Ключ динамометрический
 CZ Dynamometrický klíč
 H Nyomatékkulcs

RO Cheie cu dinamometru
 E Llave dinamométrica
 CN 扭力扳手

3/4" 1/2" CrV
 19mm 12.5mm 6140



| YATO | Ø | Nm | L (mm) | Box |
|---------|----------------|----------|--------|-----|
| YT-0754 | 1/2" (12.7 mm) | 60-340 | 613 | 10 |
| YT-0755 | 3/4" (19.0 mm) | 200-1000 | 1234 | 2 |

GB Digital torque wrench
 D Elektronischer Drehmomentschlüssel
 PL Elektroniczny klucz dynamometryczny

RUS Электронный динамометрический ключ
 CZ Elektronický dynamometrický klíč
 H Elektronikus dinamométeres kulcs

RO Cheie dinamometrica electronica
 E Llave dinamométrica electronica
 CN 数显扭力扳手

1/2" LCD COLOR LEDS BEEP
 12.5mm DISPLAY 6140

QUICK RELEASE Szybko-Złaczce 2x1.5V (AA)



| YATO | Ø | Nm | L (mm) | Box |
|---------|----------------|-------|--------|-----|
| YT-0762 | 1/2" (12.7 mm) | 2-203 | 450 | 10 |

• application: industry, service stations
 • precise digital torque measurement
 • internal memory
 • certificate of calibration
 • accuracy 2%

• przeznaczenie: przemysł, serwis ogólnomechaniczny, serwis opon
 • precyzyjny, cyfrowy pomiar momentu dokręcającego
 • pamięć wewnętrzna
 • certyfikat kalibracji
 • dokładność 2%

- GB Torque angle gauge
D Winkelmesser zum Anziehen von Schrauben
PL Kątomierz do dokręcania śrub
RUS Угломер для подвёртывания болтов
CZ Úhloměr k utahování šroubů
H Nyomaték szögmérő
RO Raportor pt. înşurubat şuruburi
E Calibrador para apretar tornillos
CN 扭力角度规



1/2"
12.5mm 360° CrV

SLIDING
CARD



| | |
|-------------|---|
| YATO |  |
| YT-0593 | 12/48 |

- GB Torque multiplier
D Drehmomentverstärker
PL Mechaniczny wzmacniacz momentu

- RUS Мультипликатор крутящего момента
CZ Mechanický posilovač momentu
H Nyomaték sokszorozó

- RO Antrenor cu amplificator de forta
E Mecanismo de reforzar el momento
CN 3倍扭力倍增器

3/4"
max. 900 Nm 1"
max. 2700 Nm 3:1 CrMo
4140

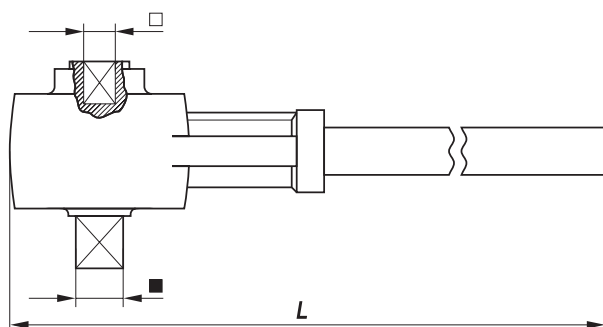

BMC &
COLOR
SLEEVE



| YATO | F <input type="checkbox"/> | Tmax. (Nm) | M <input type="checkbox"/> | Tmax. (Nm) | L (mm) |  |
|-------------|----------------------------|------------|----------------------------|------------|--------|---|
| YT-0781 | 3/4" (19.0 mm) | 900 | 1" (25.4 mm) | 2700 | 500 | 4 |



- GB Labor save wrench
D Drehmomentverstärker
PL Mechaniczny wzmacniacz momentu
RUS Механический усилитель силы
CZ Mechanický posilovač momentu
H Nyomaték sokszorozó
RO Antrenor cu amplificator de forta
E Mecanismo de reforzar el momento
CN 扭力倍增器



1"
25mm 32,33mm 4200
Nm (max) I-1:3.8
II-1:58 CrV

BMC
& COLOR
SLEEVE



| YATO |  | Nm | L (mm) |  |
|-------------|---|------|--------|---|
| YT-0782 | 1" (25.4 mm) | 4200 | 330 | 1 |

5

Screwdrivers & screwdriver bits Wkrętaki i końcówki wkrętakowe



Screwdrivers, 2 color handle
Wkrętaki, dwukolorowa rączka

84-88



| | |
|---|----|
| Slotted screwdrivers Wkrętaki płaskie..... | 84 |
| Phillips screwdrivers Wkrętaki krzyżakowe..... | 84 |
| Pozidrive screwdrivers Wkrętaki „Pozidrive”..... | 84 |
| Torx screwdrivers Wkrętaki „Torx”..... | 84 |
| Torx Security screwdrivers Wkrętaki „Torx Security”..... | 84 |
| Slotted screwdrivers with straight tip Wkrętaki płaskie z wąskim grotem..... | 85 |
| Go-through screwdrivers Wkrętaki do pobijania..... | 85 |
| Screwdriver sets Komplety wkrętaków..... | 85 |
| Precision screwdriver sets Zestawy wkrętaków precyzyjnych..... | 88 |

Screwdrivers, 3 color handle
Wkrętaki, trój kolorowa rączka

89-92



| | |
|---|----|
| Slotted screwdrivers Wkrętaki płaskie..... | 89 |
| Phillips screwdrivers Wkrętaki krzyżakowe..... | 89 |
| Pozidrive screwdrivers Wkrętaki „Pozidrive”..... | 89 |
| Torx screwdrivers Wkrętaki „Torx”..... | 89 |
| Torx Security screwdrivers Wkrętaki „Torx Security”..... | 89 |
| Go-through screwdrivers Wkrętaki do pobijania..... | 90 |
| Screwdriver sets Komplety wkrętaków..... | 90 |

Screwdrivers, 3 color handle
Wkrętaki, trój kolorowa rączka

93-94



| | |
|---|----|
| Slotted screwdrivers Wkrętaki płaskie..... | 93 |
| Phillips screwdrivers Wkrętaki krzyżakowe..... | 93 |
| Pozidrive screwdrivers Wkrętaki „Pozidrive”..... | 93 |
| Torx screwdrivers Wkrętaki „Torx”..... | 93 |
| Torx Security screwdrivers Wkrętaki „Torx Security”..... | 93 |
| Screwdriver sets Komplety wkrętaków..... | 94 |

Precision screwdrivers, 3 color handle
Wkrętaki precyzyjne, trój kolorowa rączka

95



| | |
|--|----|
| Precision slotted screwdrivers Wkrętaki precyzyjne płaskie..... | 95 |
| Precision phillips screwdrivers Wkrętaki precyzyjne krzyżakowe..... | 95 |
| Precision Pozidrive screwdrivers Wkrętaki precyzyjne „Pozidrive”..... | 95 |
| Precision Torx screwdrivers Wkrętaki precyzyjne „Torx”..... | 95 |

| | |
|---|----|
| Precision screwdriver sets Zestawy wkrętaków precyzyjnych..... | 95 |
|---|----|

Insulated screwdrivers
Wkrętaki izolowane

96



| | |
|---|----|
| Insulated slotted screwdrivers Wkrętaki izolowane płaskie..... | 96 |
| Insulated phillips screwdrivers Wkrętaki izolowane krzyżakowe..... | 96 |
| Insulated Pozidrive screwdrivers Wkrętaki izolowane „Pozidrive”..... | 96 |
| Insulated screwdriver sets Komplety wkrętaków izolowanych..... | 96 |

Special screwdrivers & impact screwdrivers
Wkrętaki specjalne i udarowe

97-99



| | |
|--|----|
| Ratchet screwdriver sets Wkrętaki z grzechotką..... | 97 |
| Impact screwdrivers Wkrętaki udarowe..... | 99 |

Screwdriver bits
Kończówki wkrętakowe

100-105



| | |
|---|-----|
| Phillips screwdriver bits Kończówki wkrętakowe krzyżakowe..... | 100 |
| Torx screwdriver bits Kończówki wkrętakowe „Torx”..... | 100 |
| YATO NON-SLIP SYSTEM screwdriver bits Kończówki wkrętakowe „YATO NON-SLIP SYSTEM”..... | 100 |
| Screwdriver bit sets Zestawy końcówek wkrętakowych..... | 100 |

Nut setters
Nasadki magnetyczne do wkrętarek

106



Screwdriver bit holders
Uchwyty do końcówek wkrętakowych

106



Hex & Torx keys & sets
Klucze imbusowe i zestawy

106-110



| | |
|--|-----|
| Hex keys with handle Klucze imbusowe z rękojeścią..... | 106 |
| Hex keys & sets Klucze imbusowe i zestawy..... | 107 |
| Torx Tamperproof keys Klucze imbusowe „Torx Tamperproof”..... | 110 |
| Plastic covered Hex keys Klucze imbusowe powlekane..... | 110 |

GB Screwdriver H Csavarhúzó
 D Schraubendreher RO Șurubelniță
 PL Wkrętak E Destornillador
 RUS Отвёртка CN 螺丝刀
 CZ Šroubovák

PLASTIC HANGER



COLOR BOX



PCS packing:



S2

HRC 58



| YATO | ⊖ | L (mm) | PCS packing: | |
|---------|---|--------|--------------|--------|
| YT-2675 | 2 | 75 | 12 | 96/384 |
| YT-2760 | 3 | 75 | 12 | 96/384 |
| YT-2761 | 3 | 100 | 12 | 96/384 |
| YT-2715 | 3 | 150 | 12 | 60/240 |
| YT-2716 | 3 | 200 | 12 | 60/240 |
| YT-2676 | 4 | 100 | 12 | 96/384 |
| YT-2677 | 4 | 150 | 12 | 96/384 |
| YT-2678 | 4 | 200 | 12 | 96/384 |

| YATO | ⊖ | L (mm) | PCS packing: | |
|---------|---|--------|--------------|--------|
| YT-2679 | 5 | 38 | 12 | 60/240 |
| YT-2762 | 5 | 75 | 12 | 60/240 |
| YT-2763 | 5 | 100 | 12 | 60/240 |
| YT-2764 | 5 | 150 | 12 | 60/240 |
| YT-2717 | 5 | 200 | 12 | 36/144 |
| YT-2718 | 5 | 250 | 6 | 36/144 |
| YT-2719 | 5 | 300 | 6 | 24/96 |
| YT-2765 | 6 | 38 | 12 | 60/240 |

| YATO | ⊖ | L (mm) | PCS packing: | |
|---------|---|--------|--------------|--------|
| YT-2766 | 6 | 100 | 12 | 36/144 |
| YT-2767 | 6 | 150 | 12 | 36/144 |
| YT-2768 | 6 | 200 | 12 | 36/144 |
| YT-2721 | 6 | 300 | 6 | 24/96 |
| YT-2769 | 8 | 150 | 6 | 24/96 |
| YT-2722 | 8 | 200 | 6 | 24/96 |
| YT-2723 | 8 | 250 | 6 | 24/96 |



| YATO | ⊕ | L (mm) | PCS packing: | |
|---------|------|--------|--------------|--------|
| YT-2682 | PH00 | 65 | 12 | 96/384 |
| YT-2770 | PH0 | 75 | 12 | 96/384 |
| YT-2771 | PH0 | 100 | 12 | 96/384 |
| YT-2725 | PH0 | 150 | 12 | 60/240 |
| YT-2683 | PH1 | 38 | 12 | 60/240 |
| YT-2772 | PH1 | 75 | 12 | 60/240 |
| YT-2773 | PH1 | 100 | 12 | 60/240 |

| YATO | ⊕ | L (mm) | PCS packing: | |
|---------|-----|--------|--------------|--------|
| YT-2774 | PH1 | 150 | 12 | 60/240 |
| YT-2727 | PH1 | 200 | 12 | 36/144 |
| YT-2728 | PH1 | 250 | 6 | 36/144 |
| YT-2729 | PH1 | 300 | 6 | 24/96 |
| YT-2775 | PH2 | 38 | 12 | 60/240 |
| YT-2776 | PH2 | 100 | 12 | 36/144 |
| YT-2777 | PH2 | 150 | 12 | 36/144 |

| YATO | ⊕ | L (mm) | PCS packing: | |
|---------|-----|--------|--------------|--------|
| YT-2778 | PH2 | 200 | 12 | 36/144 |
| YT-2730 | PH2 | 250 | 6 | 36/144 |
| YT-2731 | PH2 | 300 | 6 | 24/96 |
| YT-2779 | PH3 | 150 | 6 | 24/96 |
| YT-2732 | PH3 | 200 | 6 | 24/96 |
| YT-2733 | PH3 | 250 | 6 | 24/96 |



| YATO | ⊕ | L (mm) | PCS packing: | |
|---------|-----|--------|--------------|--------|
| YT-2686 | PZ0 | 75 | 12 | 96/384 |
| YT-2687 | PZ0 | 100 | 12 | 96/384 |
| YT-2688 | PZ1 | 75 | 12 | 60/240 |

| YATO | ⊕ | L (mm) | PCS packing: | |
|---------|-----|--------|--------------|--------|
| YT-2689 | PZ1 | 100 | 12 | 60/240 |
| YT-2690 | PZ1 | 200 | 12 | 36/144 |
| YT-2691 | PZ2 | 100 | 12 | 36/144 |

| YATO | ⊕ | L (mm) | PCS packing: | |
|---------|-----|--------|--------------|--------|
| YT-2692 | PZ2 | 150 | 12 | 36/144 |
| YT-2693 | PZ2 | 200 | 12 | 36/144 |
| YT-2694 | PZ3 | 150 | 6 | 24/96 |



| YATO | ⊗ | L (mm) | PCS packing: | |
|---------|----|--------|--------------|--------|
| YT-2620 | T5 | 75 | 12 | 96/384 |

| YATO | ⊗ | L (mm) | PCS packing: | |
|---------|----|--------|--------------|--------|
| YT-2621 | T6 | 75 | 12 | 96/384 |



| YATO | ⊗ | L (mm) | PCS packing: | |
|---------|-----|--------|--------------|--------|
| YT-2622 | T7 | 75 | 12 | 96/384 |
| YT-2623 | T8 | 75 | 12 | 96/384 |
| YT-2624 | T9 | 75 | 12 | 96/384 |
| YT-2625 | T10 | 100 | 12 | 60/240 |

| YATO | ⊗ | L (mm) | PCS packing: | |
|---------|-----|--------|--------------|--------|
| YT-2626 | T15 | 100 | 12 | 60/240 |
| YT-2627 | T20 | 100 | 12 | 60/240 |
| YT-2628 | T25 | 100 | 12 | 36/144 |
| YT-2629 | T27 | 100 | 12 | 36/144 |

| YATO | ⊗ | L (mm) | PCS packing: | |
|---------|-----|--------|--------------|--------|
| YT-2630 | T30 | 100 | 12 | 36/144 |
| YT-2631 | T40 | 100 | 6 | 24/96 |

GB Screwdriver
D Schraubendreher
PL Wkrętak
RUS Отвёртка
CZ Šroubovák

H Csavarhúzó
RO Şurubelniţă
E Destornillador
CN 螺丝刀

PLASTIC
HANGER



PCS
packing:

COLOR BOX



S2

HRC
58



- application: for deep seated screws, e. g. in power tool casings
- przeznaczenie: do wkrętów głęboko osadzonych, np. w obudowach elektronarzędzi
- cut tip, constant diameter of shaft and tip
- grot frezowany, stała średnica grotu i końcówki

| YATO | ⊖ | L (mm) | PCS packing: | |
|---------|---|--------|--------------|--------|
| YT-2840 | 5 | 150 | 12 | 60/240 |
| YT-2841 | 5 | 200 | 12 | 36/144 |
| YT-2842 | 5 | 250 | 6 | 36/144 |
| YT-2843 | 5 | 300 | 6 | 24/96 |

| YATO | ⊖ | L (mm) | PCS packing: | |
|---------|---|--------|--------------|--------|
| YT-2844 | 6 | 150 | 12 | 36/144 |
| YT-2845 | 6 | 200 | 12 | 36/144 |
| YT-2846 | 6 | 250 | 6 | 36/144 |
| YT-2847 | 6 | 300 | 6 | 24/96 |

GB Go-through screwdriver
D Schlagschrauber
PL Wkrętak do pobijania
RUS Отвёртка-било
CZ Šroubovák s úderným koncem

H Beütő csavarhúzó
RO Şurubelniţă pt. fixare
E Destornillador para dar golpes
CN 敲击螺丝批

PLASTIC
HANGER



6 PCS

COLOR BOX



CrV

HRC
52



| YATO | ⊖ | L (mm) | PCS packing: | |
|---------|---|--------|--------------|-------|
| YT-2699 | 6 | 100 | 6 | 24/96 |
| YT-2700 | 6 | 150 | 6 | 24/96 |
| YT-2701 | 6 | 200 | 6 | 24/96 |
| YT-2702 | 6 | 250 | 6 | 24/96 |

| YATO | ⊖ | L (mm) | PCS packing: | |
|---------|---|--------|--------------|-------|
| YT-2703 | 8 | 150 | 6 | 24/72 |
| YT-2704 | 8 | 200 | 6 | 24/72 |
| YT-2705 | 8 | 250 | 6 | 24/72 |
| YT-2706 | 8 | 300 | 6 | 24/72 |



| YATO | ⊕ | L (mm) | PCS packing: | |
|---------|-----|--------|--------------|-------|
| YT-2708 | PH2 | 100 | 6 | 24/96 |
| YT-2709 | PH2 | 150 | 6 | 24/96 |
| YT-2710 | PH3 | 150 | 6 | 24/72 |

| YATO | ⊕ | L (mm) | PCS packing: | |
|---------|-----|--------|--------------|-------|
| YT-2711 | PH3 | 200 | 6 | 24/72 |
| YT-2712 | PH3 | 250 | 6 | 24/72 |

GB Screwdriver set
D Schraubendrehersatz
PL Komplet wkrętaków

RUS Набор отвёрток
CZ Zámečnické šroubováky
H Lakatos csavarhózó

RO Şurubelniţe de lăcătuşerie
E Juego de destornilladores
CN 螺丝批组套

2
PCS



CrV

HRC
52



DOUBLE
BLISTER



| YATO | ⊖ | ⊕ | L (mm) | |
|---------|---|-----|------------|------|
| YT-1600 | 6 | PH2 | 150 150 | 6/36 |

GB Screwdriver set
 D Schraubendrehersatz
 PL Komplet wkręteków
 RUS Набор отвёрток
 CZ Zámečnické šroubováky

H Lakatos csavarhózó
 RO Şurubelniţe de lăcătuşerie
 E Juego de destornilladores
 CN 螺丝批组套

DOUBLE
 BLISTER



6
 PCS
 ⊖
 ⊕

| YATO | ⊖ | ⊕ | L (mm) | |
|---------|---|-----|--------|------|
| YT-2783 | 3 | | 75 | 6/24 |
| | 5 | | 100 | |
| | 6 | | 100 | |
| | | PH0 | 75 | |
| | | PH1 | 100 | |
| | | PH2 | 100 | |



8
 PCS
 ⊖
 ⊕

| YATO | ⊖ | ⊕ | L (mm) | |
|---------|-----|-----|--------|------|
| YT-2782 | 2.0 | | 50 | 6/24 |
| | 2.4 | | 50 | |
| | 6.0 | | 38 | |
| | 6.0 | | 100 | |
| | | PH0 | 50 | |
| | | PH1 | 50 | |
| | | PH2 | 38 | |
| | | PH2 | 100 | |



8
 PCS
 ⊖
 ⊕

| YATO | ⊖ | ⊕ | L (mm) | |
|---------|---|-----|--------|------|
| YT-2784 | 5 | | 100 | 6/12 |
| | 6 | | 100 | |
| | 8 | | 150 | |
| | | PH0 | 75 | |
| | | PH1 | 100 | |
| | | PH2 | 38 | |
| | | PH2 | 100 | |
| | | PH3 | 150 | |



12
 PCS
 ⊖
 ⊕
 ⊙

| YATO | ⊖ | ⊕ | ⊙ | L (mm) | |
|---------|---|-----|-----|--------|------|
| YT-2787 | 3 | | | 75 | 6/12 |
| | 5 | | | 75 | |
| | 6 | | | 38 | |
| | 6 | | | 150 | |
| | 8 | | | 150 | |
| | | PH0 | | 75 | |
| | | PH1 | | 75 | |
| | | PH2 | | 38 | |
| | | PH2 | | 100 | |
| | | PH3 | | 150 | |
| | | | SQ1 | 100 | |
| | | | SQ2 | 100 | |



15
 PCS
 ⊖
 ⊕
 ⊙

| YATO | ⊖ | ⊕ | ⊙ | L (mm) | |
|---------|-----|------|----|--------|------|
| YT-2788 | 1.5 | | | 50 | 6/24 |
| | 2.0 | | | 50 | |
| | 5.0 | | | 75 | |
| | 6.0 | | | 38 | |
| | 6.0 | | | 100 | |
| | 6.0 | | | 125 | |
| | | PH00 | | 50 | |
| | | PH0 | | 50 | |
| | | PH1 | | 75 | |
| | | PH2 | | 38 | |
| | | PH2 | | 100 | |
| | | | T5 | 50 | |
| | | | T6 | 50 | |
| | | | T7 | 50 | |
| | | | T8 | 50 | |

Screwdrivers & screwdriver bits

Wkrętaki i końcówki wkrętakowe



- GB 6 in 1 interchangeable screwdriver set
- D Umsteckschraubendreher
- PL Wkrętak z końcówkami dwustronnymi
- RUS Отвёртка с двухсторонними насадками
- CZ Šroubovák lances
- z dvoustrannou koncovkou
- H Csavarhúzó kétvégű szárral
- RO Şurubelniţă cu dublu capăt
- E Destornillador con punta de dos caras
- CN 6合1螺丝批组套



⊖ 5.0 mm PH1
⊕ 6.0 mm PH2
⊖ 6 8 mm
MAGNETIC TIP
S2

DOUBLE BLISTER

| | |
|-------------|-------|
| YATO | |
| YT-2781 | 12/96 |

- GB Screwdriver set
- RO Şurubelniţe de lăcătuşerie
- D Schraubendrehersatz
- E Juego de destornilladores
- PL Komplet wkrętaków
- H Lakatos csavarhúzó
- RUS Набор отвёрток
- CZ Zámečnické šroubováky
- CN 螺丝批组套

U
S2
HRC 58



PLASTIC HANGER & DOUBLE BLISTER

DOUBLE BLISTER

- ⊖ 1/4" (6.3 mm): 5, 8 mm (L=25 mm);
- ⊕ 1/4" (6.3 mm): PH1, PH2, PH3 (L=25 mm);
- ⊖ 1/4" (6.3 mm): T10, T15 (L=25 mm);
- ⊕ 1/4" (6.3 mm): 4, 5, 6 mm (L=25 mm)

9 PCS
⊖
⊕

PLASTIC HANGER

18 PCS
⊖
⊕
⊗

27 PCS
⊖
⊕
MAGNETIC TIP

| YATO | ⊖ | ⊕ | L (mm) | |
|---------|---|-----|--------|------|
| YT-2785 | 3 | | 75 | 6/12 |
| | 5 | | 75 | |
| | 6 | | 100 | |
| | 6 | | 150 | |
| | 8 | | 150 | |
| | | PH0 | 75 | |
| | | PH1 | 75 | |
| | | PH2 | 100 | |
| | | PH2 | 150 | |

| YATO | ⊖ | ⊕ | ⊗ | L (mm) | |
|---------|-----|------|----|--------|------|
| YT-2786 | 2.4 | | | 50 | 6/12 |
| | 3.0 | | | 50 | |
| | 5.0 | | | 75 | |
| | 6.0 | | | 38 | |
| | 6.0 | | | 100 | |
| | 6.0 | | | 150 | |
| | | PH00 | | 50 | |
| | | PH0 | | 50 | |
| | | PH1 | | 75 | |
| | | PH2 | | 38 | |
| | | PH2 | | 100 | |
| | | PH3 | | 150 | |
| | | | T5 | 50 | |
| | | | T6 | 50 | |
| | | | T7 | 50 | |
| | | | T8 | 50 | |
| | | T9 | 50 | | |
| | | T10 | 50 | | |

| YATO | ⊖ | ⊕ | L (mm) | |
|---------|-----|------|--------|------|
| YT-2789 | 2.0 | | 50 | 2/10 |
| | 2.4 | | 50 | |
| | 3.0 | | 75 | |
| | 5.0 | | 75 | |
| | 6.0 | | 38 | |
| | 6.0 | | 100 | |
| | 6.0 | | 150 | |
| | 8.0 | | 150 | |
| | | PH00 | 50 | |
| | | PH0 | 50 | |
| | | PH0 | 75 | |
| | | PH1 | 75 | |
| | | PH2 | 38 | |
| | | PH2 | 100 | |
| | PH3 | 150 | | |

- GB Mini pick & hook set
- D Mini hacken set
- PL Zestaw haczyków z rękojeścią
- RUS Набор ключков с рукоятками
- CZ Sada háčkových mini páčidel
- H Mini ár és kampó készlet
- RO Mini-set pt. extras garnituri
- E Juego de palancas de hierro
- CN 迷你拉拔器组套

4 PCS
U
HRC 40



SLIDING CARD

| | |
|-------------|-------|
| YATO | |
| YT-0843 | 12/72 |

- GB Precision screwdriver set
- D Präzisions-Feinmechanikersatz
- PL Zestaw wkrętek precyzyjnych
- RUS Набор прецизионных отвёрток
- CZ Šroubováky sada pro jemnou mechaniku
- H Órás csavarhúzó készlet
- RO Set surubelnite
- E Destornilladores precisos
- CN 螺丝批组套



PLASTIC BOX & DOUBLE BLISTER

6 PCS



HRC 58



6 PCS



HRC 58



S2

| YATO | ⊖ | ⊕ | L (mm) | |
|---------|-----|------|--------|-------|
| YT-2790 | 1.4 | | 50 | 15/60 |
| | 2.0 | | 50 | |
| | 2.4 | | 50 | |
| | | PH00 | 50 | |
| | | PH0 | 50 | |
| | | PH1 | 50 | |

| YATO | ⊗ | L (mm) | |
|---------|-----|--------|-------|
| YT-2791 | T5 | 50 | 15/60 |
| | T6 | 50 | |
| | T7 | 50 | |
| | T8 | 50 | |
| | T9 | 50 | |
| | T10 | 50 | |



6 PCS



7 PCS



HRC 58



7 PCS



| YATO | ⊗ | L (mm) | |
|---------|-----|--------|------|
| YT-2576 | T5 | 40 | 6/36 |
| | T6 | 40 | |
| | T7 | 40 | |
| | T8 | 40 | |
| | T9 | 40 | |
| | T10 | 40 | |

| YATO | ⊖ | ⊕ | ⊗ | L (mm) | |
|---------|-----|------|----|--------|------|
| YT-2795 | 2.4 | | | 40 | 6/36 |
| | 3.0 | | | 40 | |
| | | PH00 | | 40 | |
| | | PH0 | | 40 | |
| | | | T6 | 40 | |
| | | | T7 | 40 | |
| | | | T8 | 40 | |

| YATO | ⊖ | ⊕ | ⊗ | L (mm) | |
|---------|-----|------|-----|--------|------|
| YT-2577 | 2.4 | | | 40 | 6/36 |
| | 3.0 | | | 40 | |
| | | PH00 | | 40 | |
| | | PH0 | | 40 | |
| | | | T8 | 40 | |
| | | | T9 | 40 | |
| | | | T10 | 40 | |

- GB Long precision screwdriver set
- D Präzisions-Feinmechanikersatz
- PL Zestaw wkrętek precyzyjnych długich
- RUS Набор прецизионных отвёрток
- CZ Šroubováky sada pro jemnou mechaniku
- H Órás csavarhúzó készlet
- RO Set surubelnite
- E Destornilladores precisos
- CN 长钟表螺丝批组套



6 PCS



SLIDING CARD

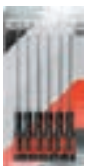

| YATO | ⊖ | ⊕ | L (mm) | |
|---------|-----|------|--------|--------|
| YT-2575 | 2.5 | | 150 | 12/120 |
| | 3.0 | | 150 | |
| | 3.5 | | 150 | |
| | | PH00 | 150 | |
| | | PH0 | 150 | |
| | | PH1 | 150 | |

GB Screwdriver H Csavarhúzó
D Schraubendreher RO Șurubelniță
PL Wkrętak E Destornillador
RUS Отвёртка CN 螺丝刀
CZ Sroubovák

PLASTIC
HANGER



PCS
packing:

COLOR BOX



S2

HRC
58



| YATO | ⊖ | L (mm) | PCS packing: |  |
|----------|---|--------|-----------------|---|
| YT-25900 | 2 | 75 | 12 | 96/384 |
| YT-25901 | 3 | 75 | 12 | 96/384 |
| YT-25902 | 3 | 100 | 12 | 96/384 |
| YT-25903 | 3 | 150 | 12 | 60/240 |
| YT-25904 | 4 | 100 | 12 | 96/384 |
| YT-25905 | 4 | 150 | 12 | 96/384 |
| YT-25906 | 4 | 200 | 12 | 96/384 |
| YT-25907 | 5 | 75 | 12 | 60/240 |

| YATO | ⊖ | L (mm) | PCS packing: |  |
|----------|---|--------|-----------------|---|
| YT-25908 | 5 | 100 | 12 | 60/240 |
| YT-25909 | 5 | 150 | 12 | 60/240 |
| YT-25910 | 6 | 38 | 12 | 60/240 |
| YT-25911 | 6 | 100 | 12 | 36/144 |
| YT-25912 | 6 | 150 | 12 | 36/144 |
| YT-25913 | 6 | 200 | 12 | 36/144 |
| YT-25914 | 8 | 150 | 6 | 24/96 |



| YATO | ⊕ | L (mm) | PCS packing: |  |
|----------|-----|--------|-----------------|---|
| YT-25920 | PH0 | 75 | 12 | 96/384 |
| YT-25921 | PH0 | 100 | 12 | 96/384 |
| YT-25922 | PH1 | 38 | 12 | 60/240 |
| YT-25923 | PH1 | 75 | 12 | 60/240 |
| YT-25924 | PH1 | 100 | 12 | 60/240 |
| YT-25925 | PH1 | 150 | 12 | 60/240 |
| YT-25926 | PH1 | 200 | 12 | 36/144 |
| YT-25927 | PH1 | 300 | 6 | 24/96 |

| YATO | ⊕ | L (mm) | PCS packing: |  |
|----------|-----|--------|-----------------|---|
| YT-25928 | PH2 | 38 | 12 | 60/240 |
| YT-25929 | PH2 | 100 | 12 | 36/144 |
| YT-25930 | PH2 | 150 | 12 | 36/144 |
| YT-25931 | PH2 | 200 | 12 | 36/144 |
| YT-25932 | PH2 | 300 | 6 | 24/96 |
| YT-25933 | PH3 | 150 | 6 | 24/96 |
| YT-25934 | PH3 | 200 | 6 | 24/96 |



| YATO | ⊕ | L (mm) | PCS packing: |  |
|----------|-----|--------|-----------------|---|
| YT-25940 | PZ1 | 75 | 12 | 60/240 |
| YT-25941 | PZ1 | 100 | 12 | 60/240 |

| YATO | ⊕ | L (mm) | PCS packing: |  |
|----------|-----|--------|-----------------|---|
| YT-25942 | PZ2 | 100 | 12 | 36/144 |
| YT-25943 | PZ2 | 150 | 12 | 36/144 |



| YATO | ⊕ | L (mm) | PCS packing: |  |
|----------|----|--------|-----------------|---|
| YT-25950 | T5 | 75 | 12 | 96/384 |

| YATO | ⊕ | L (mm) | PCS packing: |  |
|----------|----|--------|-----------------|---|
| YT-25951 | T6 | 75 | 12 | 96/384 |



| YATO | ⊕ | L (mm) | PCS packing: |  |
|----------|-----|--------|-----------------|---|
| YT-25952 | T7 | 75 | 12 | 96/384 |
| YT-25953 | T8 | 75 | 12 | 96/384 |
| YT-25954 | T9 | 75 | 12 | 96/384 |
| YT-25955 | T10 | 100 | 12 | 60/240 |
| YT-25956 | T15 | 100 | 12 | 60/240 |

| YATO | ⊕ | L (mm) | PCS packing: |  |
|----------|-----|--------|-----------------|---|
| YT-25957 | T20 | 100 | 12 | 60/240 |
| YT-25958 | T25 | 100 | 12 | 36/144 |
| YT-25959 | T27 | 100 | 12 | 36/144 |
| YT-25960 | T30 | 100 | 12 | 36/144 |
| YT-25961 | T40 | 100 | 6 | 24/96 |

GB Go-through screwdriver
 D Schlagschrauber
 PL Wkrętek do robienia
 RUS Отвёртка-било
 CZ Šroubovák s úderným koncem

H Beütő csavarhúzó
 RO Şurubelniţă pt. fixare
 E Destornillador para dar golpes
 CN 敲击螺丝批

PLASTIC HANGER



6 PCS

COLOR BOX



CrV 6150

HRC 52



| YATO | ⊖ | L (mm) | PCS packing | |
|----------|---|--------|-------------|-------|
| YT-25985 | 6 | 100 | 6 | 24/96 |
| YT-25986 | 6 | 150 | 6 | 24/96 |
| YT-25987 | 6 | 200 | 6 | 24/96 |
| YT-25988 | 6 | 250 | 6 | 24/96 |
| YT-25989 | 8 | 150 | 6 | 24/72 |
| YT-25990 | 8 | 200 | 6 | 24/72 |
| YT-25991 | 8 | 250 | 6 | 24/72 |
| YT-25992 | 8 | 300 | 6 | 24/72 |

| YATO | ⊕ | L (mm) | PCS packing | |
|----------|-----|--------|-------------|-------|
| YT-25993 | PH2 | 100 | 6 | 24/96 |
| YT-25994 | PH2 | 150 | 6 | 24/96 |
| YT-25995 | PH3 | 150 | 6 | 24/72 |
| YT-25996 | PH3 | 200 | 6 | 24/72 |
| YT-25997 | PH3 | 250 | 6 | 24/72 |

5

GB Screwdriver set
 D Schraubendrehersatz
 PL Komplet wkręteków

RUS Набор отвёрток
 CZ Zámečnické šroubováky
 H Lakatos csavarhózó

RO Şurubelniţe de lăcătuşerie
 E Juego de destornilladores
 CN 螺丝批组套

2 PCS



CrV 6150

HRC 52



DOUBLE BLISTER

| YATO | ⊖ | ⊕ | L (mm) | |
|----------|---|-----|--------|------|
| YT-25998 | 6 | | 150 | 6/36 |
| | | PH2 | 150 | |

GB Screwdriver set
 D Schraubendrehersatz
 PL Komplet wkręteków
 RUS Набор отвёрток
 CZ Zámečnické šroubováky

H Lakatos csavarhózó
 RO Şurubelniţe de lăcătuşerie
 E Juego de destornilladores
 CN 螺丝批组套

DOUBLE BLISTER



S2

HRC 58



6 PCS



| YATO | ⊖ | ⊕ | L (mm) | |
|----------|-----|-----|--------|------|
| YT-25965 | 3.0 | | 75 | 6/24 |
| | 5.0 | | 100 | |
| | 6.0 | | 100 | |
| | | PH0 | 75 | |
| | | PH1 | 100 | |
| | | PH2 | 100 | |



8 PCS



| YATO | ⊖ | ⊕ | L (mm) | |
|----------|-----|-----|--------|------|
| YT-25980 | 2.0 | | 50 | 6/24 |
| | 2.4 | | 50 | |
| | 6.0 | | 38 | |
| | 6.0 | | 100 | |
| | | PH0 | 50 | |
| | | PH1 | 50 | |
| | | PH2 | 38 | |
| | | PH2 | 100 | |

GB Screwdriver set
D Schraubendrehersatz
PL Komplet wkrętaków
RUS Набор отвёрток
CZ Zámečnické šroubováky

H Lakatos csavarhózó
RO Şurubelnițe de lăcătușerie
E Juego de destornilladores
CN 螺丝批组套

DOUBLE
BLISTER



S2

HRC
58



8
PCS



12
PCS



| YATO | ⊖ | ⊕ | L (mm) | |
|----------|-----|-----|--------|------|
| YT-25966 | 5.0 | | 100 | 6/12 |
| | 6.0 | | 100 | |
| | 8.0 | | 150 | |
| | | PH0 | 75 | |
| | | PH1 | 100 | |
| | | PH2 | 38 | |
| | | PH2 | 100 | |
| | | PH3 | 150 | |

| YATO | ⊖ | ⊕ | ⊗ | L (mm) | |
|----------|-----|-----|-----|--------|------|
| YT-25967 | 3.0 | | | 75 | 6/12 |
| | 5.0 | | | 75 | |
| | 6.0 | | | 38 | |
| | 6.0 | | | 150 | |
| | 8.0 | | | 150 | |
| | | PH0 | | 75 | |
| | | PH1 | | 75 | |
| | | PH2 | | 38 | |
| | | PH2 | | 100 | |
| | | PH3 | | 150 | |
| | | SQ1 | 100 | | |
| | | SQ2 | 100 | | |



15
PCS



| YATO | ⊖ | ⊕ | ⊗ | L (mm) | |
|----------|-----|------|----|--------|------|
| YT-25981 | 1.5 | | | 50 | 6/24 |
| | 2.0 | | | 50 | |
| | 5.0 | | | 75 | |
| | 6.0 | | | 38 | |
| | 6.0 | | | 100 | |
| | 6.0 | | | 125 | |
| | | PH00 | | 50 | |
| | | PH0 | | 50 | |
| | | PH1 | | 75 | |
| | | PH2 | | 38 | |
| | | PH2 | | 100 | |
| | | | T5 | 50 | |
| | | | T6 | 50 | |
| | | | T7 | 50 | |
| | | T8 | 50 | | |

GB 6 in 1 interchangeable screwdriver set
D Umsteckschraubendreher
PL Wkrętak z końcówkami dwustronnymi
RUS Отвёртка с двухсторонними насадками
CZ Šroubovák lances
z dvoustrannou koncovkou
H Csavarhózó kétvégű szárral
RO Şurubelniță cu dublu capăt
E Destornillador con punta de dos caras
CN 6合1螺丝批组套



⊖ 5.0
mm
⊕ PH1

⊖ 6.0
mm
⊕ PH2

1/4"
(6.3 mm)
5/16"
(8 mm)

MAGNETIC
TIP

S2

DOUBLE
BLISTER



YATO

YT-25971

12/96

GB Screwdriver set
D Schraubendrehersatz
PL Komplet wkręteków

RUS Набор отвёрток
CZ Zámečnické šroubováky
H Lakatos csavarhózó

RO Șurubelnițe de lăcătușerie
E Juego de destornilladores
CN 螺丝批组套



S2

HRC 58

5



9 PCS  

PLASTIC HANGER



| YATO | ⊖ | ⊕ | L (mm) | |
|----------|-----|-----|--------|------|
| YT-25968 | 3.0 | | 75 | 6/12 |
| | 5.0 | | 75 | |
| | 6.0 | | 100 | |
| | 6.0 | | 150 | |
| | 8.0 | | 150 | |
| | | PH0 | 75 | |
| | | PH1 | 75 | |
| | | PH2 | 100 | |
| | | PH2 | 150 | |
| | | | | |



18 PCS   

PLASTIC HANGER & DOUBLE BLISTER



| YATO | ⊖ | ⊕ | ★ | L (mm) | |
|----------|-----|------|----|--------|------|
| YT-25982 | 2.4 | | | 50 | 6/12 |
| | 3.0 | | | 50 | |
| | 5.0 | | | 75 | |
| | 6.0 | | | 38 | |
| | 6.0 | | | 100 | |
| | 8.0 | | | 150 | |
| | | PH00 | | 50 | |
| | | PH0 | | 50 | |
| | | PH1 | | 75 | |
| | | PH2 | | 38 | |
| | | PH2 | | 100 | |
| | | PH3 | | 150 | |
| | | | T5 | 50 | |
| | | | T6 | 50 | |
| | | | T7 | 50 | |
| | | | T8 | 50 | |
| | | T9 | 50 | | |
| | | T10 | 50 | | |

GB Screwdriver RUS Отвёртка RO Şurubelniţă
D Schraubendreher CZ Šroubovák E Destornillador
PL Wkrętak H Csavarhúzó CN 螺丝刀

COLOR BOX

SVCM55







- application: industry
- can be used as go-through
- special highest quality alloy steel
- przeznaczenie: przemysł
- możliwość pobijania
- stal wysokostopowa



 **HRC 58-62**

 **HRC 55-59**

| YATO  | ⊖ | L (mm) | PCS packing |  |
|--|-----|--------|-------------|---|
| YT-2601 | 3.0 | 75 | 12 | 240 |
| YT-2606 | 4.0 | 100 | 12 | 240 |
| YT-2608 | 5.5 | 100 | 12 | 240 |
| YT-2609 | 5.5 | 150 | 12 | 240 |
| YT-2610 | 5.5 | 200 | 12 | 240 |
| YT-2612 | 6.5 | 38 | 12 | 240 |
| YT-2613 | 6.5 | 100 | 12 | 240 |
| YT-2614 | 6.5 | 150 | 12 | 240 |
| YT-2615 | 6.5 | 200 | 12 | 240 |
| YT-2618 | 8.0 | 150 | 6 | 120 |



| YATO  | ⊖ | L (mm) | PCS packing |  |
|--|-----|--------|-------------|---|
| YT-2602 | 3.0 | 100 | 12 | 240 |
| YT-2633 | 3.0 | 300 | 12 | 240 |
| YT-2603 | 4.0 | 38 | 12 | 240 |
| YT-2604 | 4.0 | 75 | 12 | 240 |
| YT-2607 | 4.0 | 150 | 12 | 240 |
| YT-2634 | 4.0 | 400 | 12 | 240 |
| YT-2635 | 5.0 | 300 | 12 | 120 |
| YT-2636 | 5.0 | 400 | 12 | 120 |
| YT-2619 | 8.0 | 200 | 6 | 120 |



- application: industry
- can be used as go-through
- special highest quality alloy steel
- przeznaczenie: przemysł
- możliwość pobijania
- stal wysokostopowa



 **HRC 58-62**

 **HRC 55-59**

| YATO  | ⊕ | L (mm) | PCS packing |  |
|---|-----|--------|-------------|--|
| YT-2640 | PH0 | 75 | 12 | 240 |
| YT-2642 | PH1 | 75 | 12 | 240 |
| YT-2643 | PH1 | 100 | 12 | 240 |
| YT-2644 | PH1 | 150 | 12 | 240 |
| YT-2645 | PH1 | 200 | 12 | 240 |
| YT-2647 | PH2 | 38 | 12 | 240 |
| YT-2648 | PH2 | 100 | 12 | 240 |
| YT-2649 | PH2 | 150 | 12 | 240 |
| YT-2650 | PH2 | 200 | 12 | 240 |
| YT-2651 | PH2 | 250 | 12 | 240 |
| YT-2653 | PH3 | 150 | 6 | 120 |



| YATO  | ⊕ | L (mm) | PCS packing |  |
|---|-----|--------|-------------|--|
| YT-2637 | PH0 | 300 | 12 | 240 |
| YT-2641 | PH1 | 38 | 12 | 240 |
| YT-2638 | PH1 | 400 | 12 | 120 |
| YT-2639 | PH2 | 400 | 12 | 120 |



- application: industry
- can be used as go-through
- special highest quality alloy steel
- przeznaczenie: przemysł
- możliwość pobijania
- stal wysokostopowa



 **HRC 58-62**

 **HRC 55-59**

| YATO  | ⊕ | L (mm) | PCS packing |  |
|--|-----|--------|-------------|---|
| YT-2661 | PZ0 | 75 | 12 | 240 |
| YT-2663 | PZ1 | 100 | 12 | 240 |
| YT-2665 | PZ2 | 150 | 12 | 240 |
| YT-2667 | PZ3 | 150 | 6 | 240 |

| YATO  | ⊕ | L (mm) | PCS packing |  |
|--|-----|--------|-------------|---|
| YT-2656 | PZ0 | 300 | 12 | 240 |
| YT-2654 | PZ1 | 38 | 12 | 240 |
| YT-2657 | PZ1 | 400 | 12 | 120 |
| YT-2655 | PZ2 | 38 | 12 | 240 |
| YT-2658 | PZ2 | 400 | 12 | 120 |



- application: industry
- can be used as go-through
- special highest quality alloy steel
- przeznaczenie: przemysł
- możliwość pobijania
- stal wysokostopowa









 **HRC 58-62**

 **HRC 58-62**

 **HRC 55-59**

| YATO  |  | L (mm) | PCS packing |  |
|--|---|--------|-------------|---|
| YT-2741 | T5 | 75 | 12 | 240 |
| YT-2742 | T6 | 75 | 12 | 240 |

| YATO  |  | L (mm) | PCS packing |  |
|--|---|--------|-------------|---|
| YT-2743 | T7 | 75 | 12 | 240 |
| YT-2744 | T8 | 75 | 12 | 240 |
| YT-2745 | T9 | 75 | 12 | 240 |
| YT-2746 | T10 | 100 | 12 | 240 |
| YT-2748 | T15 | 100 | 12 | 240 |
| YT-2750 | T20 | 100 | 12 | 240 |
| YT-2752 | T25 | 100 | 12 | 240 |
| YT-2753 | T27 | 100 | 12 | 240 |
| YT-2754 | T30 | 100 | 12 | 240 |
| YT-2756 | T40 | 100 | 12 | 240 |

| YATO  |  | L (mm) | PCS packing |  |
|--|---|--------|-------------|---|
| YT-2757 | T45 | 100 | 12 | 240 |

GB Screwdriver set
 D Schraubendrehersatz
 PL Komplet wkrętasków
 RUS Набор отвёрток
 CZ Zámečnické šroubováky

H Lakatos csavarhózó
 RO Şurubelniţe de lăcătuşerie
 E Juego de destornilladores
 CN 螺丝批

DOUBLE
 BLISTER





SVCM
55

HRC
58-62

5





6
 PCS  

| YATO  | ⊖ | ⊕ | L (mm) |  |
|--|-----|-----|--------|---|
| YT-2668 | 5.5 | | 100 | 6/24 |
| | 6.5 | | 100 | |
| | 8.0 | | 150 | |
| | | PH1 | 100 | |
| | | PH2 | 100 | |
| | | PH3 | 150 | |





7
 PCS   

| YATO  | ⊖ | ⊕ | ⊕ | L (mm) |  |
|--|-----|-----|-----|--------|---|
| YT-2669 | 5.5 | | | 100 | 4/16 |
| | 6.5 | | | 38 | |
| | 6.5 | | | 150 | |
| | | PH1 | | 100 | |
| | | PH2 | | 150 | |
| | | | PZ1 | 100 | |
| | | PZ2 | 150 | | |



8
 PCS  

| YATO  | ⊖ | ⊕ | L (mm) |  |
|--|-----|-----|--------|---|
| YT-2670 | 4.0 | | 100 | 4/16 |
| | 5.5 | | 100 | |
| | 6.5 | | 38 | |
| | 6.5 | | 100 | |
| | | PH0 | 75 | |
| | | PH1 | 100 | |
| | | PH2 | 38 | |
| | | PH2 | 100 | |

GB Precision screwdriver
D Präzisions-Schraubendreher
PL Wkrętak precyzyjny

RUS Отвёртка для точных работ
CZ Šroubovák pro jemnou mechaniku
H Műszerész csavarhúzó

RO Șurubelniță mecanica fina
E Destornillador de precisión
CN 螺丝批

S2

HRC
57-61





| YATO | ⊖ | L (mm) |  |
|----------|-----|--------|---|
| YT-25802 | 1.4 | 50 | 50/400 |
| YT-25803 | 1.6 | 50 | 50/400 |
| YT-25804 | 1.8 | 50 | 50/400 |
| YT-25805 | 2.0 | 50 | 50/400 |
| YT-25806 | 2.0 | 75 | 50/400 |
| YT-25807 | 2.4 | 50 | 50/400 |
| YT-25808 | 2.4 | 75 | 50/400 |
| YT-25809 | 3.0 | 50 | 50/400 |
| YT-25810 | 3.0 | 75 | 50/400 |
| YT-25811 | 3.0 | 100 | 50/400 |

| YATO | ⊕ | L (mm) |  |
|----------|-------|--------|---|
| YT-25831 | PH000 | 50 | 50/400 |
| YT-25832 | PH000 | 75 | 50/400 |
| YT-25833 | PH00 | 50 | 50/400 |
| YT-25834 | PH00 | 75 | 50/400 |
| YT-25835 | PH0 | 50 | 50/400 |
| YT-25836 | PH0 | 75 | 50/400 |
| YT-25837 | PH0 | 100 | 50/400 |
| YT-25838 | PH1 | 50 | 50/400 |
| YT-25839 | PH1 | 100 | 50/400 |
| YT-25840 | PH1 | 150 | 50/400 |



| YATO | ⊕ | L (mm) |  |
|----------|-----|--------|---|
| YT-25841 | PZ0 | 50 | 50/400 |
| YT-25842 | PZ0 | 75 | 50/400 |
| YT-25843 | PZ0 | 100 | 50/400 |
| YT-25844 | PZ1 | 50 | 50/400 |
| YT-25845 | PZ1 | 100 | 50/400 |
| YT-25846 | PZ1 | 150 | 50/400 |

| YATO |  | L (mm) |  |
|----------|---|--------|---|
| YT-25852 | T5 | 50 | 50/400 |
| YT-25853 | T6 | 50 | 50/400 |
| YT-25854 | T7 | 50 | 50/400 |
| YT-25855 | T8 | 50 | 50/400 |
| YT-25856 | T9 | 50 | 50/400 |
| YT-25857 | T10 | 50 | 50/400 |

GB Precision screwdriver set
D Präzisions-Feinmechanikersatz
PL Zestaw wkrętaków precyzyjnych
RUS Набор прецизионных отвёрток
CZ Šroubováky sada pro jemnou mechaniku

H Órás csavarhúzó készlet
RO Set șurubelnițe
E Destornilladores precisos
CN 螺丝批组套

PLASTIC BOX
& DOUBLE
BLISTER

S2

HRC
57-61



6
PCS





6
PCS





7
PCS



| YATO | ⊖ | ⊕ | L (mm) |  |
|----------|-----|------|--------|---|
| YT-25861 | 1.4 | | 50 | 6/36 |
| | 2.0 | | 50 | |
| | 2.4 | | 50 | |
| | | PH00 | 50 | |
| | | PH0 | 50 | |
| | | PH1 | 50 | |

| YATO |  | L (mm) |  |
|----------|---|--------|---|
| YT-25862 | T5 | 50 | 6/36 |
| | T6 | 50 | |
| | T7 | 50 | |
| | T8 | 50 | |
| | T9 | 50 | |
| | T10 | 50 | |

| YATO | ⊖ | ⊕ |  | L (mm) |  |
|----------|-----|------|---|--------|---|
| YT-25863 | 2.0 | | | 50 | 6/36 |
| | 3.0 | | | 50 | |
| | | PH00 | | 50 | |
| | | PH0 | | 50 | |
| | | | T5 | 50 | |
| | | | T6 | 50 | |
| | | | T7 | 50 | |
| | | | | | |

GB Insulated screwdriver
 D Isolierte Schraubendreher
 PL Wkrętak izolowany
 RUS Изолированная отвёртка
 CZ Izolovaný šroubovák

H Szigetelt csavarhúzó
 RO Şurubelniţă izolată
 E Destornillador aislado
 CN 绝缘螺丝批

PLASTIC HANGER



1000 V S2 HRC 56-60



⊖ • application: industry • przeznaczenie: przemysł
 • VDE certificate • certyfikat VDE

| YATO | ⊖ | L (mm) | ☐ |
|---------|-----|--------|--------|
| YT-2815 | 3.0 | 75 | 12/120 |
| YT-2816 | 4.0 | 75 | 12/120 |
| YT-2817 | 4.0 | 100 | 12/120 |

| YATO | ⊖ | L (mm) | ☐ |
|---------|-----|--------|--------|
| YT-2818 | 5.5 | 125 | 12/120 |
| YT-2819 | 6.5 | 150 | 12/120 |
| YT-2820 | 8.0 | 175 | 12/120 |

5



⊕ • application: industry • przeznaczenie: przemysł
 • VDE certificate • certyfikat VDE

| YATO | ⊕ | L (mm) | ☐ |
|---------|-----|--------|--------|
| YT-2821 | PH0 | 60 | 12/120 |
| YT-2822 | PH1 | 80 | 12/120 |

| YATO | ⊕ | L (mm) | ☐ |
|---------|-----|--------|--------|
| YT-2823 | PH2 | 100 | 12/120 |
| YT-2824 | PH3 | 150 | 12/120 |



⊕ • application: industry • przeznaczenie: przemysł
 • VDE certificate • certyfikat VDE

| YATO | ⊕ | L (mm) | ☐ |
|---------|-----|--------|--------|
| YT-2825 | PZ1 | 80 | 12/120 |

| YATO | ⊕ | L (mm) | ☐ |
|---------|-----|--------|--------|
| YT-2826 | PZ2 | 100 | 12/120 |

GB Insulated screwdriver set
 D Isolierte Schraubendrehersatz
 PL Komplet wkrętaków izolowanych
 RUS Изолированная отвёртка - набор
 CZ Izolované šroubováky

H Szigetelt csavarhúzó
 RO Şurubelniţă izolată
 E Juego de destornilladores aislado
 CN 绝缘螺丝批组套

DOUBLE BLISTER



1000 V S2 HRC 56-60



5 PCS

⊖

⊕



7 PCS

⊖

⊕

⊕

• application: industry • przeznaczenie: przemysł
 • VDE certificate • certyfikat VDE

• application: industry • przeznaczenie: przemysł
 • VDE certificate • certyfikat VDE

| YATO | ⊖ | ⊕ | L (mm) | ☐ |
|---------|-----|-----|--------|-------|
| YT-2827 | 3.0 | | 75 | 20/40 |
| | 4.0 | | 100 | |
| | 5.5 | | 125 | |
| | | PH1 | 80 | |
| | | PH2 | 100 | |

| YATO | ⊖ | ⊕ | ⊕ | L (mm) | ☐ |
|---------|-----|-----|-----|--------|-------|
| YT-2828 | 3.0 | | | 75 | 20/40 |
| | 4.0 | | | 100 | |
| | 5.5 | | | 125 | |
| | | PH1 | | 80 | |
| | | PH2 | | 100 | |
| | | | PZ1 | 80 | |
| | | | PZ2 | 100 | |

- GB Ratchet screwdriver set
D Ratschenschraubendreher-Satz mit einsetzen
PL Zestaw wkrętak z grzechotką
RUS Набор головок с трещоткой
CZ Ráčnový kloubový šroubovák s příslušenstvím
H Dugókulcs és bit készlet csukló
RO Set surubelnita
E Juego con destornillador y carraca
CN 棘轮螺丝批组套

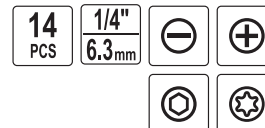

- 5, 6 mm;
⊕ PH1, PH2;
⊕ T15, T20;
○ 5, 6, 7, 8, 10, 12, 13 mm



YATO
YT-2804 6/36

- GB 22 in 1 interchangeable screwdriver set
D Umsteckschraubendreher
PL Wkrętak z końcówkami dwustronnymi
RUS Отвёртка - двухсторонние насадки
CZ Šroubovák lancer z dvoustrannou koncovkou

- H Csavarhúzó kétfélgű szárral
RO Șurubelniță cu dublu capăt
E Destornillador con punta dos caras
CN 22合一螺丝批组套

DOUBLE BLISTER

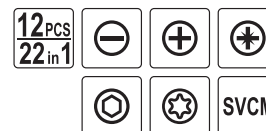

- 4 mm x 5.5 mm (L=175/115 mm);
□ 6.5 mm x PH3 (L=175/115 mm);
⊕ PH1 x PH2 (L=175/115 mm);
⊕ PZ1 x PZ2 (L=175/115 mm);
○ 3 mm x 3 mm (L=175/115 mm);
○ 4 mm x 4 mm (L=175/115 mm);
○ 5 mm x 5 mm (L=175/115 mm);
○ 6 mm x 6 mm (L=175/115 mm);
⊕ T10 x T15 (L=175/115 mm);
⊕ T20 x T25 (L=175/115 mm);
⊕ T30 x T40 (L=175/115 mm)



YATO
YT-2797 6/12

- GB Ratchet screwdriver set
D Ratschenschraubendreher-set mit einsetzen
PL Wkrętak z grzechotką, nasadkami i bitami
RUS Набор головок с трещоткой
CZ Ráčnový kloubový šroubovák s příslušenstvím

- H Dugókulcs és bit készlet csukló
RO Set surubelnita
E Juego con destornillador y carraca
CN 棘轮螺丝批组套

DOUBLE BLISTER

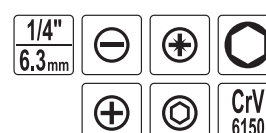

S2



- 1/4" (6.3 mm): 3.5, 4.0, 5.5, 6.5 mm (L=25 mm);
⊕ 1/4" (6.3 mm): PH0, PH1, PH2, PH3 (L=25 mm);
⊕ 1/4" (6.3 mm): PZ0, PZ1, PZ2, PZ3 (L=25 mm);
○ 1/4" (6.3 mm): 4.0, 5.0, 6.0 mm (L=25 mm);
□ 1/4" (6.3 mm): 5, 6(x2), 7(x2), 8, 9(x2), 10(x2), 11, 13 mm; CrV 6150;
□ 1/4" (6.3 mm) x 1/4" (6.3 mm); (L=30 mm)

29 PCS

YATO
YT-2808 6/36

- 1/4" (6.3 mm): 3.5, 4.0, 5.5, 6.5 mm (L=25 mm);
⊕ 1/4" (6.3 mm): PH0, PH1, PH2, PH3 (L=25 mm);
⊕ 1/4" (6.3 mm): PZ0, PZ1, PZ2, PZ3 (L=25 mm);
○ 1/4" (6.3 mm): 4.0, 5.0, 6.0 mm (L=25 mm);
□ 1/4" (6.3 mm): 5, 6(x2), 7(x2), 8, 9(x2), 10(x2), 11, 13 mm; CrV 6150;
□ 1/4" (6.3 mm) x 1/4" (6.3 mm); (L=30 mm); □ 1/4" (6.3 mm); (L=30 mm)

30 PCS

YATO
YT-2798 6/36

GB Ratchet screwdriver set
D Ratschenschraubendreher-Satz mit einsätzen
PL Wkrętak z grzechotką, przegubem i bitami
RUS Набор головок с трещеткой

CZ Ráčnový kloubový šroubovák s příslušenstvím
H Dugókulcs és bit készlet csukló
RO Set surubelnita
E Juego con destornillador y carraca
CN 棘轮螺丝批组套

BMC WITH WINDOW & COLOR BOX



1/4"
6.3mm

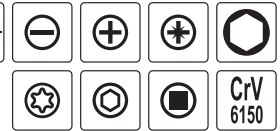

CrV
6150

S2

50
PCS

METRIC
& S.A.E.



- 1/4" (6.3 mm): 2.0, 3.0, 3.5, 4.0, 4.5, 5.5, 6.5 mm (L=25 mm); S2;
- ✦ 1/4" (6.3 mm): PH0, PH1, PH2, PH3 (L=25 mm); S2;
- ✦ 1/4" (6.3 mm): PZ0, PZ1, PZ2, PZ3 (L=25 mm); S2;
- ⊛ 1/4" (6.3 mm): T10, T15, T20, T25, T27, T30 (L=25 mm); S2;
- ⊙ 1/4" (6.3 mm): 2.0, 3.0, 4.0, 5.0, 6.0 mm (L=25 mm); S2;
- 1/4" (6.3 mm): SQ0, SQ1, SQ2, SQ3 (L=25 mm); S2;
- ⊙ 1/4" (6.3 mm): 5, 6, 7, 8, 9, 10, 11, 12, 13 mm; CrV 6150;
- ⊙ 1/4" (6.3 mm): 1/4" (6.3 mm) x 3/16" (4.8 mm), 1/4" (6.3 mm) x 7/32" (5.6 mm), 1/4" (6.3 mm) x 1/4" (6.3 mm), 1/4" (6.3 mm) x 5/16" (7.9 mm), 1/4" (6.3 mm) x 11/32" (8.7 mm), 1/4" (6.3 mm) x 3/8" (9.5 mm), 1/4" (6.3 mm) x 7/16" (11.1 mm), 1/4" (6.3 mm) x 15/32" (11.9 mm), 1/4" (6.3 mm) x 1/2" (12.7 mm); CrV 6150;
- ⊙ 1/4" (6.3 mm): (L=150 mm)

YATO

YT-2799

6/24

75
PCS



- 1/4" (6.3 mm): 2.0(x2), 3.0(x2), 3.5(x2), 4.0(x2), 4.5(x2), 5.0(x2), 5.5(x2), 6.5(x2) mm (L=25 mm); S2;
- ✦ 1/4" (6.3 mm): PH0(x2), PH1(x2), PH2(x2), PH3(x2) (L=25 mm); S2;
- ✦ 1/4" (6.3 mm): PZ0(x3), PZ1(x3), PZ2(x2), PZ3(x2) (L=25 mm); S2;
- ⊛ 1/4" (6.3 mm): T10(x3), T15(x3), T20(x3), T25(x3), T27(x2), T30(x2) (L=25 mm); S2;
- ⊙ 1/4" (6.3 mm): 2.0, 3.0, 4.0, 5.0, 6.0 mm (L=25 mm); S2;
- 1/4" (6.3 mm): SQ0(x2), SQ1(x2), SQ2(x2), SQ3(x2) (L=25 mm); S2;
- ⊙ 1/4" (6.3 mm): 5, 6, 7, 8, 9, 10, 11, 12, 13 mm; CrV 6150;
- 1/4" (6.3 mm): (L=60 mm); CrV 6150/S2

YATO

YT-2571

6/24

GB Precision screwdriver with bits
D Schraubendreher und bit-satz
PL Wkrętak elastyczny z wymiennymi bitami
RUS Отвёртка с прецизионными битами
CZ Šroubovák ráčnový se sadou bitů
H Órás csavarահւծ-իտ կէշլէտ
RO Surubelnita + set biti
E Juego de pizas terminales para destornillador + mango
CN 可弯曲批头组套

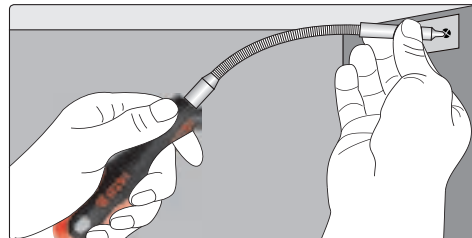

DOUBLE
BLISTER



31
PCS

1/4"
6.3mm



S2

CrV
6150

215 mm;

- 1/4" (6.3 mm): 3.0, 3.5, 4.0, 5.5, 6.5 mm (L=25 mm);
- ✦ 1/4" (6.3 mm): PH0, PH1, PH2, PH3 (L=25 mm);
- ✦ 1/4" (6.3 mm): PZ0, PZ1, PZ2, PZ3 (L=25 mm);
- ⊛ 1/4" (6.3 mm): T10, T15 (L=25 mm);
- ⊙ 1/4" (6.3 mm): 2.0, 3.0, 4.0, 5.0, 6.0 mm (L=25 mm);
- 1/4" (6.3 mm): 5.0, 6.0, 7.0, 8.0(x2), 9.0, 10.0, 11.0, 12.0, 13.0 mm



YATO

YT-2780

6/24

215 mm;

- 1/4" (6.3 mm): 3.0, 3.5, 4.0, 5.5, 6.5 mm (L=25 mm);
- ✦ 1/4" (6.3 mm): PH0, PH1, PH2, PH3 (L=25 mm);
- ✦ 1/4" (6.3 mm): PZ0, PZ1, PZ2, PZ3 (L=25 mm);
- ⊛ 1/4" (6.3 mm): T10, T15 (L=25 mm);
- ⊙ 1/4" (6.3 mm): 2.0, 3.0, 4.0, 5.0, 6.0 mm (L=25 mm);
- 1/4" (6.3 mm): 5.0, 6.0, 7.0, 8.0(x2), 9.0, 10.0, 11.0, 12.0, 13.0 mm



YATO

YT-25972









6/24

GB Ratchet screwdriver set
D Ratschenschraubendreher-Satz mit einstecken
PL Wkrętak z grzechotką, przegubem i bitami
RUS Набор головок с трещеткой

CZ Ráčnový kloubový šroubovák s příslušenstvím
H Dugókulcs és bit készlet csukló
RO Set surubelnita
E Juego con destornillador y carraca
CN 棘轮螺丝批组套

PLASTIC BOX
& COLOR BOX



| | | | | |
|---------------------|---|---|---|---|
| 42 PCS | 1/4" |  |  |  |
| | 6.3mm |  |  |  |
| BITS x30 AISI S2 |  |  |  | CrV 50BV30 |



1/4" (6.3 mm): 5, 6, 7, 8, 9, 10, 11, 12, 13 mm; 1/4" (6.3 mm) x 100 mm;
1/4" (6.3 mm): CrV 50BV30; H2, H2.5, H3, H4, H5, H6;
T10, T15, T20, T25, T27, T30, T40; PH1, PH1, PH2, PH2, PH3, PH3;
3, 4, 5, 6, 7 mm; PZ1, PZ1, PZ2, PZ2, PZ3, PZ3

| | |
|-------------|---|
| YATO |  |
| YT-2806 | 12 |

GB Impact screwdriver
D Schlagschrauber
PL Wkrętak udarowy

RUS Отвёртка ударная
CZ Narazový šroubovák kovový
H Csavarbehajtó, ütő üzemmóddal

RO Şurubelniţă metalică cu percutor
E Destornillador de percusión
CN 冲击螺丝批组套

| | | | | |
|---------------------|---|---|---|---|
| BITS x6 CrV 6150 |  |  |  |  |
| | 1/2" | 12.5mm | 5/16" | 8.0mm |



8
PCS
5/16" (7.9 mm) 1/2" (12.7 mm);
PH2, PH3 (L=35 mm); PH2 (L=80 mm);
8, 10 mm (L=35 mm); 8 mm (L=80 mm)



BMC
& COLOR BOX

7
PCS
5/16" (7.9 mm) 1/2" (12.7 mm);
PH2, PH3 (L=35 mm); PH2 (L=80 mm);
8, 10 mm (L=35 mm); 8 mm (L=80 mm)



METAL CASE
& COLOR BOX

| | |
|-------------|---|
| YATO |  |
| YT-2800 | 20 |

| | |
|-------------|---|
| YATO |  |
| YT-2801 | 5/20 |



7
PCS
5/16" (7.9 mm) 1/2" (12.7 mm);
PH3 (L=35 mm); PH1, PH2, PH3 (L=75 mm);
8 mm (L=35 mm); 8 mm (L=75 mm)



BMC
& COLOR BOX

| | |
|-------------|---|
| YATO |  |
| YT-2802 | 20 |

GB Screwdriver bit set
D Schraubendreherbitsatz
PL Zestaw bitów do wkrętek uderowych
RUS Набор бит крестовых

CZ Sada bitů
H Bitkészlet
RO Truse bit
E Puntas de destornilladora
CN 冲击批头组套

CrV
6150



SLIDING CARD

for / dla: YT-2800, YT-2801

| YATO | + | - | L (mm) | ⊕ (mm) | PCS packing | 📦 |
|---------|-----|----|--------|----------------|-------------|--------|
| YT-2810 | PH2 | | 36 | 5/16" (7.9 mm) | 5 | 10/100 |
| YT-2811 | PH3 | | 36 | 5/16" (7.9 mm) | 5 | 10/100 |
| YT-2812 | PH2 | 8 | 36 | 5/16" (7.9 mm) | 4 | 10/100 |
| | PH3 | 10 | | | | |

GB Screwdriver bit
D Schraubendreherbit
PL Końcówka śrubokrętowa
RUS Бит крестовая
CZ Sroubovaková koncovka

H Csavarhúzóvég
RO Capăt pt. șurubelniță
E Punta de destornilladora
CN 旋具头

BLISTER CARD



TORX

AIISI
S2



| YATO | ⊕ | L (mm) | ⊕ (mm) | 📦 |
|----------|-----|--------|--------|--------|
| YT-0404 | T25 | 30 | 10 | 10/100 |
| YT-0405 | T25 | 75 | 10 | 10/100 |
| YT-04051 | T30 | 30 | 10 | 10/100 |
| YT-04052 | T30 | 75 | 10 | 10/100 |
| YT-0406 | T40 | 30 | 10 | 10/100 |
| YT-0407 | T40 | 75 | 10 | 10/100 |
| YT-0408 | T45 | 30 | 10 | 10/100 |
| YT-0409 | T45 | 75 | 10 | 10/100 |

GB Screwdriver bit
D Schraubendreherbit
PL Końcówka śrubokrętowa
RUS Бит крестовая
CZ Sroubovaková koncovka

H Csavarhúzóvég
RO Capăt pt. șurubelniță
E Punta de destornilladora
CN 旋具头



+

COLD FORGED KUTE NA ZIMNO

21.8 Nm max.

AIISI
S2

HRC
58-62



SLIDING CARD



| YATO | + | L (mm) | ⊕ (mm) | 📦 |
|---------|-----|--------|---------------|--------|
| YT-0485 | PH2 | 100 | 1/4" (6.3 mm) | 25/100 |
| YT-0486 | PH2 | 150 | 1/4" (6.3 mm) | 25/100 |
| YT-0487 | PH2 | 200 | 1/4" (6.3 mm) | 25/100 |

GB Screwdriver bit
D Schraubendreherbit
PL Końcówka śrubokrętowa

RUS Бит крестовая
CZ Sroubovaková koncovka

RO Capăt pt. șurubelniță
E Punta de destornilladora
CN 旋具头组套

PLASTIC BOX



AIISI
S2

HRC
58-61

COLD FORGED KUTE NA ZIMNO



| YATO | + | L (mm) | ⊕ (mm) | torque / moment obrotowy max. (Nm) | PCS packing | 📦 |
|----------|-----|--------|---------------|------------------------------------|-------------|--------|
| YT-04702 | PZ1 | 25 | 1/4" (6.3 mm) | 6.4 | 10 | 25/200 |
| YT-04712 | PZ2 | 25 | 1/4" (6.3 mm) | 19.6 | 10 | 25/200 |
| YT-04722 | PZ3 | 25 | 1/4" (6.3 mm) | 45.1 | 10 | 25/200 |

| YATO | + | L (mm) | ⊕ (mm) | torque / moment obrotowy max. (Nm) | PCS packing | 📦 |
|----------|-----|--------|---------------|------------------------------------|-------------|--------|
| YT-04742 | PH1 | 25 | 1/4" (6.3 mm) | 6.4 | 10 | 25/200 |
| YT-04752 | PH2 | 25 | 1/4" (6.3 mm) | 19.6 | 10 | 25/200 |
| YT-04762 | PH3 | 25 | 1/4" (6.3 mm) | 45.1 | 10 | 25/200 |



| YATO | + | L (mm) | ⊕ (mm) | torque / moment obrotowy max. (Nm) | PCS packing | 📦 |
|----------|-----|--------|---------------|------------------------------------|-------------|--------|
| YT-04772 | PH1 | 50 | 1/4" (6.3 mm) | 6.4 | 10 | 25/100 |
| YT-04782 | PH2 | 50 | 1/4" (6.3 mm) | 19.6 | 10 | 25/100 |
| YT-04792 | PH3 | 50 | 1/4" (6.3 mm) | 45.1 | 10 | 25/100 |

| YATO | + | + | L (mm) | ⊕ (mm) | torque / moment obrotowy max. (Nm) | PCS packing | 📦 |
|----------|-----|-----|--------|---------------|------------------------------------|-------------|--------|
| YT-04812 | PH2 | PH2 | 65 | 1/4" (6.3 mm) | 19.6 / 19.6 | 10 | 25/100 |

GB Screwdriver bit set
D Schraubendreherbitsatz
PL Zestaw końcówek śrubokrętowych
RUS Набор битов
CZ Sada bitů

H Bitkészlet
RO Truse bit
E Puntas de destornilladora de destornilladora
CN 旋具头组套

PLASTIC BOX



10 PCS

AIISI
S2

HRC
58-61

COLD FORGED KUTE NA ZIMNO



⊕ 5, 6 mm; ⊕ PH1, PH1, PH2, PH2;
⊕ PZ1, PZ1, PZ2, PZ2

| YATO | L (mm) | ⊕ (mm) | 📦 |
|----------|--------|---------------|--------|
| YT-04822 | 25 | 1/4" (6.3 mm) | 25/200 |



⊕ 5, 6 mm; ⊕ PH1, PH1, PH2, PH2;
⊕ PZ1, PZ1, PZ2, PZ2

| YATO | L (mm) | ⊕ (mm) | 📦 |
|----------|--------|---------------|--------|
| YT-04832 | 50 | 1/4" (6.3 mm) | 25/100 |

GB Screwdriver bit
D Schraubendreherbit
PL Końcówka śrubokrętowa

RUS Бит крестовая
CZ Šroubováková koncovka
H Csavarhúzóvég

RO Capăt pt. șurubelniță
E Punta de destornilladora
CN 旋具头组套

PLASTIC BOX



AISI S2

HRC 58-61



| YATO | + | L (mm) | torque / moment obrotowy max. (Nm) | PCS packing |
|----------|-----|--------|------------------------------------|-------------|
| YT-78130 | PH0 | 25 | 1/4" (6.3 mm) 2.1 | 10 20/100 |
| YT-78131 | PH1 | 25 | 1/4" (6.3 mm) 7.8 | 10 20/100 |
| YT-78132 | PH2 | 25 | 1/4" (6.3 mm) 19.6 | 10 20/100 |
| YT-78133 | PH3 | 25 | 1/4" (6.3 mm) 45.6 | 10 20/100 |

| YATO | + | L (mm) | torque / moment obrotowy max. (Nm) | PCS packing |
|----------|-----|--------|------------------------------------|-------------|
| YT-78134 | PZ1 | 25 | 1/4" (6.3 mm) 6.4 | 10 20/100 |
| YT-78135 | PZ2 | 25 | 1/4" (6.3 mm) 19.6 | 10 20/100 |
| YT-78136 | PZ3 | 25 | 1/4" (6.3 mm) 45.1 | 10 20/100 |



| YATO | + | L (mm) | torque / moment obrotowy max. (Nm) | PCS packing |
|----------|-----|--------|------------------------------------|-------------|
| YT-78141 | T10 | 25 | 1/4" (6.3 mm) 5.9 | 10 20/100 |
| YT-78142 | T15 | 25 | 1/4" (6.3 mm) 8.4 | 10 20/100 |
| YT-78143 | T20 | 25 | 1/4" (6.3 mm) 14.7 | 10 20/100 |
| YT-78144 | T25 | 25 | 1/4" (6.3 mm) 21.6 | 10 20/100 |
| YT-78145 | T27 | 25 | 1/4" (6.3 mm) 29.4 | 10 20/100 |
| YT-78146 | T30 | 25 | 1/4" (6.3 mm) 45.1 | 10 20/100 |
| YT-78147 | T40 | 25 | 1/4" (6.3 mm) 76.5 | 10 20/100 |

| YATO | + | L (mm) | torque / moment obrotowy max. (Nm) | PCS packing |
|----------|-----|--------|------------------------------------|-------------|
| YT-78150 | PH0 | 50 | 1/4" (6.3 mm) 2.1 | 10 20/100 |
| YT-78151 | PH1 | 50 | 1/4" (6.3 mm) 6.4 | 10 20/100 |
| YT-78152 | PH2 | 50 | 1/4" (6.3 mm) 19.6 | 10 20/100 |
| YT-78153 | PH3 | 50 | 1/4" (6.3 mm) 45.1 | 10 20/100 |



| YATO | + | L (mm) | torque / moment obrotowy max. (Nm) | PCS packing |
|----------|-----|--------|------------------------------------|-------------|
| YT-78154 | PZ1 | 50 | 1/4" (6.3 mm) 6.4 | 10 20/100 |
| YT-78155 | PZ2 | 50 | 1/4" (6.3 mm) 19.6 | 10 20/100 |
| YT-78156 | PZ3 | 50 | 1/4" (6.3 mm) 45.1 | 10 20/100 |

| YATO | + | + | L (mm) | torque / moment obrotowy max. (Nm) | PCS packing |
|----------|-----|-----|--------|------------------------------------|-------------|
| YT-78160 | PH1 | PH1 | 65 | 1/4" (6.3 mm) 6.4 / 6.4 | 10 20/100 |
| YT-78161 | PH2 | PH2 | 65 | 1/4" (6.3 mm) 19.6 / 19.6 | 10 20/100 |
| YT-78162 | PH3 | PH3 | 65 | 1/4" (6.3 mm) 45.1 / 45.1 | 10 20/100 |
| YT-78163 | PH1 | PH2 | 65 | 1/4" (6.3 mm) 6.4 / 19.6 | 10 20/100 |
| YT-78164 | PH2 | PH3 | 65 | 1/4" (6.3 mm) 19.6 / 45.1 | 10 20/100 |



| YATO | + | + | L (mm) | torque / moment obrotowy max. (Nm) | PCS packing |
|----------|-----|-----|--------|------------------------------------|-------------|
| YT-78165 | PH1 | 4.5 | 65 | 1/4" (6.3 mm) 6.4 / 6.1 | 10 20/100 |
| YT-78166 | PH2 | 5.5 | 65 | 1/4" (6.3 mm) 19.6 / 8.8 | 10 20/100 |
| YT-78167 | PH3 | 6.5 | 65 | 1/4" (6.3 mm) 45.1 / 14.7 | 10 20/100 |

| YATO | + | L (mm) | (mm) | torque / moment obrotowy max. (Nm) | PCS packing |
|----------|-----|--------|------|------------------------------------|-------------|
| YT-78190 | M5 | 30 | 8 | 20.6 | 10 20/100 |
| YT-78191 | M6 | 30 | 8 | 40.2 | 10 20/100 |
| YT-78192 | M8 | 30 | 8 | 60.8 | 10 20/100 |
| YT-78193 | M10 | 30 | 8 | 156.9 | 8 10/50 |
| YT-78194 | M12 | 30 | 8 | 176.5 | 6 10/50 |

GB Screwdriver bit set
D Schraubendreherbitsatz
PL Zestaw końcówek śrubokrętowych

RUS Набор битов
CZ Sada bitů
H Bitkészlet
RO Truse bit

E Puntas de destornilladora
CN 旋具头组套



SLIDING CARD



COLD FORGED KUTE NA ZIMNO

218^{Nm} max.

AISI S2

HRC 58-62



10 PCS



10 PCS



10 PCS



| YATO | + | L (mm) | PCS |
|---------|-----|--------|----------------------|
| YT-0470 | PZ1 | 25 | 1/4" (6.3 mm) 25/200 |
| YT-0471 | PZ2 | 25 | 1/4" (6.3 mm) 25/200 |
| YT-0472 | PZ3 | 25 | 1/4" (6.3 mm) 25/200 |

| YATO | + | L (mm) | PCS |
|---------|-----|--------|----------------------|
| YT-0477 | PH1 | 50 | 1/4" (6.3 mm) 25/100 |
| YT-0478 | PH2 | 50 | 1/4" (6.3 mm) 25/100 |
| YT-0479 | PH3 | 50 | 1/4" (6.3 mm) 25/100 |
| YT-0480 | PH2 | 75 | 1/4" (6.3 mm) 25/100 |

| YATO | + | L (mm) | PCS |
|---------|-----|--------|----------------------|
| YT-0473 | PH0 | 25 | 1/4" (6.3 mm) 25/200 |
| YT-0474 | PH1 | 25 | 1/4" (6.3 mm) 25/200 |
| YT-0475 | PH2 | 25 | 1/4" (6.3 mm) 25/200 |
| YT-0476 | PH3 | 25 | 1/4" (6.3 mm) 25/200 |



10 PCS



10 PCS



10 PCS



□ 5, 6 mm; ⊕ PH1, PH1, PH2, PH2;
⊕ PZ1, PZ1, PZ2, PZ2

□ 5, 6 mm; ⊕ PH1, PH1, PH2, PH2;
⊕ PZ1, PZ1, PZ2, PZ2

| YATO | + | L (mm) | PCS |
|---------|-----|--------|----------------------|
| YT-0481 | PH2 | 65 | 1/4" (6.3 mm) 25/100 |

| YATO | + | L (mm) | PCS |
|---------|---|--------|----------------------|
| YT-0482 | | 25 | 1/4" (6.3 mm) 25/200 |

| YATO | + | L (mm) | PCS |
|---------|---|--------|----------------------|
| YT-0483 | | 50 | 1/4" (6.3 mm) 25/100 |

GB Screwdriver bit
D Schraubendreherbit
PL Końcówka śrubokręto

RUS Бит крестовая
CZ Sroubovákova koncovka
H Csavarhúzóvég

RO Capăt pt. șurubelniță
E Punta de destornillador
CN 旋具头组套

COLOR BOX



AISI S2

HRC 58-62

GOLD FORGED KUTE NA ZIMNO



| YATO | ⊖ | L (mm) | ⊖ | PCS packing | 📦 |
|---------|-----|--------|---------------|-------------|-------|
| YT-7800 | 3.0 | 25 | 1/4" (6.3 mm) | 50 | 20/40 |
| YT-7801 | 4.0 | 25 | 1/4" (6.3 mm) | 50 | 20/40 |
| YT-7802 | 5.0 | 25 | 1/4" (6.3 mm) | 50 | 20/40 |
| YT-7803 | 5.5 | 25 | 1/4" (6.3 mm) | 50 | 20/40 |
| YT-7804 | 6.0 | 25 | 1/4" (6.3 mm) | 50 | 20/40 |
| YT-7805 | 6.5 | 25 | 1/4" (6.3 mm) | 50 | 20/40 |



| YATO | ⊕ | L (mm) | ⊖ | PCS packing | 📦 |
|---------|-----|--------|---------------|-------------|-------|
| YT-7806 | PH0 | 25 | 1/4" (6.3 mm) | 50 | 20/40 |
| YT-7807 | PH1 | 25 | 1/4" (6.3 mm) | 50 | 20/40 |
| YT-7808 | PH2 | 25 | 1/4" (6.3 mm) | 50 | 20/40 |
| YT-7809 | PH3 | 25 | 1/4" (6.3 mm) | 50 | 20/40 |



| YATO | ⊕ | L (mm) | ⊖ | PCS packing | 📦 |
|---------|-----|--------|---------------|-------------|-------|
| YT-7810 | PZ1 | 25 | 1/4" (6.3 mm) | 50 | 20/40 |
| YT-7811 | PZ2 | 25 | 1/4" (6.3 mm) | 50 | 20/40 |
| YT-7812 | PZ3 | 25 | 1/4" (6.3 mm) | 50 | 20/40 |



| YATO | ★ | L (mm) | ⊖ | PCS packing | 📦 |
|---------|-----|--------|---------------|-------------|-------|
| YT-7813 | T8 | 25 | 1/4" (6.3 mm) | 50 | 20/40 |
| YT-7814 | T10 | 25 | 1/4" (6.3 mm) | 50 | 20/40 |
| YT-7815 | T15 | 25 | 1/4" (6.3 mm) | 50 | 20/40 |
| YT-7816 | T20 | 25 | 1/4" (6.3 mm) | 50 | 20/40 |
| YT-7817 | T25 | 25 | 1/4" (6.3 mm) | 50 | 20/40 |
| YT-7818 | T27 | 25 | 1/4" (6.3 mm) | 50 | 20/40 |
| YT-7819 | T30 | 25 | 1/4" (6.3 mm) | 50 | 20/40 |
| YT-7820 | T40 | 25 | 1/4" (6.3 mm) | 50 | 20/40 |



| YATO | ★ | L (mm) | ⊖ | PCS packing | 📦 |
|---------|-----|--------|---------------|-------------|-------|
| YT-7821 | T8 | 25 | 1/4" (6.3 mm) | 50 | 20/40 |
| YT-7822 | T10 | 25 | 1/4" (6.3 mm) | 50 | 20/40 |
| YT-7824 | T20 | 25 | 1/4" (6.3 mm) | 50 | 20/40 |
| YT-7825 | T25 | 25 | 1/4" (6.3 mm) | 50 | 20/40 |
| YT-7826 | T27 | 25 | 1/4" (6.3 mm) | 50 | 20/40 |
| YT-7827 | T30 | 25 | 1/4" (6.3 mm) | 50 | 20/40 |
| YT-7828 | T40 | 25 | 1/4" (6.3 mm) | 50 | 20/40 |



| YATO | ⊖ | L (mm) | ⊖ | PCS packing | 📦 |
|---------|-----|--------|---------------|-------------|-------|
| YT-7829 | 2.0 | 25 | 1/4" (6.3 mm) | 50 | 20/40 |
| YT-7830 | 2.5 | 25 | 1/4" (6.3 mm) | 50 | 20/40 |
| YT-7831 | 3.0 | 25 | 1/4" (6.3 mm) | 50 | 20/40 |
| YT-7834 | 6.0 | 25 | 1/4" (6.3 mm) | 50 | 20/40 |



| YATO | ⊖ | L (mm) | ⊖ | PCS packing | 📦 |
|---------|-----|--------|---------------|-------------|-------|
| YT-7840 | 3.0 | 50 | 1/4" (6.3 mm) | 50 | 10/20 |
| YT-7841 | 4.0 | 50 | 1/4" (6.3 mm) | 50 | 10/20 |
| YT-7842 | 5.0 | 50 | 1/4" (6.3 mm) | 50 | 10/20 |
| YT-7843 | 5.5 | 50 | 1/4" (6.3 mm) | 50 | 10/20 |
| YT-7844 | 6.0 | 50 | 1/4" (6.3 mm) | 50 | 10/20 |
| YT-7845 | 6.5 | 50 | 1/4" (6.3 mm) | 50 | 10/20 |



| YATO | ⊕ | L (mm) | ⊖ | PCS packing | 📦 |
|---------|-----|--------|---------------|-------------|-------|
| YT-7846 | PH0 | 50 | 1/4" (6.3 mm) | 50 | 10/20 |
| YT-7847 | PH1 | 50 | 1/4" (6.3 mm) | 50 | 10/20 |
| YT-7848 | PH2 | 50 | 1/4" (6.3 mm) | 50 | 10/20 |
| YT-7849 | PH3 | 50 | 1/4" (6.3 mm) | 50 | 10/20 |



| YATO | ⊕ | L (mm) | ⊖ | PCS packing | 📦 |
|---------|-----|--------|---------------|-------------|-------|
| YT-7850 | PZ1 | 50 | 1/4" (6.3 mm) | 50 | 10/20 |
| YT-7851 | PZ2 | 50 | 1/4" (6.3 mm) | 50 | 10/20 |
| YT-7852 | PZ3 | 50 | 1/4" (6.3 mm) | 50 | 10/20 |



| YATO | ★ | L (mm) | ⊖ | PCS packing | 📦 |
|---------|-----|--------|---------------|-------------|-------|
| YT-7854 | T10 | 50 | 1/4" (6.3 mm) | 50 | 10/20 |
| YT-7855 | T15 | 50 | 1/4" (6.3 mm) | 50 | 10/20 |
| YT-7856 | T20 | 50 | 1/4" (6.3 mm) | 50 | 10/20 |
| YT-7857 | T25 | 50 | 1/4" (6.3 mm) | 50 | 10/20 |
| YT-7858 | T27 | 50 | 1/4" (6.3 mm) | 50 | 10/20 |
| YT-7860 | T40 | 50 | 1/4" (6.3 mm) | 50 | 10/20 |



| YATO | ★ | L (mm) | ⊖ | PCS packing | 📦 |
|---------|-----|--------|---------------|-------------|-------|
| YT-7861 | T8 | 50 | 1/4" (6.3 mm) | 50 | 10/20 |
| YT-7862 | T10 | 50 | 1/4" (6.3 mm) | 50 | 10/20 |
| YT-7863 | T15 | 50 | 1/4" (6.3 mm) | 50 | 10/20 |
| YT-7864 | T20 | 50 | 1/4" (6.3 mm) | 50 | 10/20 |
| YT-7865 | T25 | 50 | 1/4" (6.3 mm) | 50 | 10/20 |
| YT-7866 | T27 | 50 | 1/4" (6.3 mm) | 50 | 10/20 |
| YT-7867 | T30 | 50 | 1/4" (6.3 mm) | 50 | 10/20 |
| YT-7868 | T40 | 50 | 1/4" (6.3 mm) | 50 | 10/20 |



| YATO | ⊖ | L (mm) | ⊖ | PCS packing | 📦 |
|---------|-----|--------|---------------|-------------|-------|
| YT-7869 | 2.0 | 50 | 1/4" (6.3 mm) | 50 | 10/20 |
| YT-7870 | 2.5 | 50 | 1/4" (6.3 mm) | 50 | 10/20 |
| YT-7871 | 3.0 | 50 | 1/4" (6.3 mm) | 50 | 10/20 |
| YT-7873 | 5.0 | 50 | 1/4" (6.3 mm) | 50 | 10/20 |
| YT-7874 | 6.0 | 50 | 1/4" (6.3 mm) | 50 | 10/20 |



| YATO | ⊕ | ⊕ | L (mm) | ⊖ | PCS packing | 📦 |
|---------|-----|-----|--------|---------------|-------------|-------|
| YT-7880 | PH1 | PH1 | 65 | 1/4" (6.3 mm) | 50 | 10/20 |
| YT-7881 | PH2 | PH2 | 65 | 1/4" (6.3 mm) | 50 | 10/20 |
| YT-7882 | PH3 | PH3 | 65 | 1/4" (6.3 mm) | 50 | 10/20 |
| YT-7883 | PH1 | PH2 | 65 | 1/4" (6.3 mm) | 50 | 10/20 |
| YT-7884 | PH2 | PH3 | 65 | 1/4" (6.3 mm) | 50 | 10/20 |



| YATO | ⊕ | ⊖ | L (mm) | ⊖ | PCS packing | 📦 |
|---------|-----|-----|--------|---------------|-------------|-------|
| YT-7886 | PH2 | 5.5 | 65 | 1/4" (6.3 mm) | 50 | 10/20 |
| YT-7887 | PH3 | 6.5 | 65 | 1/4" (6.3 mm) | 50 | 10/20 |



| YATO | ⊕ | ⊕ | L (mm) | ⊖ | PCS packing | 📦 |
|---------|-----|-----|--------|---------------|-------------|-------|
| YT-7888 | PH1 | PH1 | 110 | 1/4" (6.3 mm) | 20 | 10/20 |
| YT-7889 | PH2 | PH2 | 110 | 1/4" (6.3 mm) | 20 | 10/20 |
| YT-7890 | PH3 | PH3 | 110 | 1/4" (6.3 mm) | 20 | 10/20 |



GB Screwdriver bit
D Schraubendreherbit
PL Końcówka śrubokrętowa

RUS Бит крестовая
CZ Šroubovaková koncovka
H Csavarhúzóvég

RO Capăt pt. șurubelniță
E Puntă de destornilladora
CN 旋具头组套

COLOR BOX



AISI S2

HRC 58-62



| YATO | ⊖ | L (mm) | ⊖ (mm) | PCS packing | 📦 |
|---------|-----|--------|--------|-------------|-------|
| YT-7891 | 5.5 | 30 | 8 | 50 | 10/20 |
| YT-7892 | 6.5 | 30 | 8 | 50 | 10/20 |
| YT-7893 | 8.0 | 30 | 8 | 50 | 10/20 |



| YATO | ⊕ | L (mm) | ⊖ (mm) | PCS packing | 📦 |
|---------|-----|--------|--------|-------------|-------|
| YT-7897 | T10 | 30 | 8 | 50 | 10/20 |
| YT-7898 | T15 | 30 | 8 | 50 | 10/20 |
| YT-7899 | T20 | 30 | 8 | 50 | 10/20 |
| YT-7900 | T25 | 30 | 8 | 50 | 10/20 |
| YT-7901 | T27 | 30 | 8 | 50 | 10/20 |
| YT-7904 | T45 | 30 | 8 | 50 | 10/20 |
| YT-7906 | T55 | 30 | 8 | 20 | 10/40 |
| YT-7907 | T60 | 30 | 8 | 20 | 10/20 |



| YATO | ⊕ | L (mm) | ⊖ (mm) | PCS packing | 📦 |
|---------|-----|--------|--------|-------------|-------|
| YT-7909 | T15 | 30 | 8 | 50 | 10/20 |
| YT-7910 | T20 | 30 | 8 | 50 | 10/20 |
| YT-7911 | T25 | 30 | 8 | 50 | 10/20 |
| YT-7912 | T27 | 30 | 8 | 50 | 10/20 |
| YT-7913 | T30 | 30 | 8 | 50 | 10/20 |
| YT-7914 | T40 | 30 | 8 | 50 | 10/20 |
| YT-7916 | T50 | 30 | 8 | 50 | 10/20 |



| YATO | ⊖ | L (mm) | ⊖ (mm) | PCS packing | 📦 |
|---------|-----|--------|--------|-------------|-------|
| YT-7919 | 4.0 | 30 | 8 | 50 | 10/20 |
| YT-7920 | 5.0 | 30 | 8 | 50 | 10/20 |
| YT-7921 | 6.0 | 30 | 8 | 50 | 10/20 |
| YT-7922 | 7.0 | 30 | 8 | 50 | 10/20 |
| YT-7923 | 8.0 | 30 | 8 | 50 | 10/20 |



| YATO | ⊕ | L (mm) | ⊖ (mm) | PCS packing | 📦 |
|---------|-----|--------|--------|-------------|-------|
| YT-7929 | M5 | 30 | 8 | 50 | 10/20 |
| YT-7930 | M6 | 30 | 8 | 50 | 10/20 |
| YT-7931 | M8 | 30 | 8 | 50 | 10/20 |
| YT-7932 | M10 | 30 | 8 | 20 | 10/40 |
| YT-7933 | M12 | 30 | 8 | 20 | 10/20 |



| YATO | ⊖ | L (mm) | ⊖ (mm) | PCS packing | 📦 |
|---------|-----|--------|--------|-------------|-------|
| YT-7934 | 5.5 | 70 | 8 | 20 | 10/20 |
| YT-7935 | 6.5 | 70 | 8 | 20 | 10/20 |
| YT-7936 | 8.0 | 70 | 8 | 20 | 10/20 |



| YATO | ⊕ | L (mm) | ⊖ (mm) | PCS packing | 📦 |
|---------|-----|--------|--------|-------------|-------|
| YT-7939 | PH3 | 70 | 8 | 20 | 10/20 |



| YATO | ⊕ | L (mm) | ⊖ (mm) | PCS packing | 📦 |
|---------|-----|--------|--------|-------------|-------|
| YT-7940 | T10 | 70 | 8 | 20 | 10/20 |
| YT-7941 | T15 | 70 | 8 | 20 | 10/20 |
| YT-7945 | T30 | 70 | 8 | 20 | 10/20 |
| YT-7947 | T45 | 70 | 8 | 20 | 10/20 |
| YT-7949 | T55 | 70 | 8 | 20 | 5/10 |
| YT-7950 | T60 | 70 | 8 | 20 | 5/10 |



| YATO | ⊕ | L (mm) | ⊖ (mm) | PCS packing | 📦 |
|---------|-----|--------|--------|-------------|-------|
| YT-7951 | T10 | 70 | 8 | 20 | 10/20 |
| YT-7952 | T15 | 70 | 8 | 20 | 10/20 |
| YT-7954 | T25 | 70 | 8 | 20 | 10/20 |
| YT-7959 | T50 | 70 | 8 | 20 | 10/20 |
| YT-7960 | T55 | 70 | 8 | 20 | 5/10 |
| YT-7961 | T60 | 70 | 8 | 20 | 5/10 |



| YATO | ⊖ | L (mm) | ⊖ (mm) | PCS packing | 📦 |
|---------|-----|--------|--------|-------------|-------|
| YT-7962 | 4.0 | 70 | 8 | 20 | 10/20 |
| YT-7963 | 5.0 | 70 | 8 | 20 | 10/20 |
| YT-7964 | 6.0 | 70 | 8 | 20 | 10/20 |
| YT-7965 | 7.0 | 70 | 8 | 20 | 10/20 |
| YT-7966 | 8.0 | 70 | 8 | 20 | 10/20 |



| YATO | ⊕ | L (mm) | ⊖ (mm) | PCS packing | 📦 |
|---------|-----|--------|--------|-------------|-------|
| YT-7971 | M5 | 70 | 8 | 20 | 10/20 |
| YT-7975 | M12 | 70 | 8 | 20 | 5/10 |

GB Screwdriver bit
D Schraubendreherbit
PL Końcówka śrubokrętowa
RUS Бит крестовая
CZ Šroubovaková koncovka
H Csavarhúzóvég
RO Capăt pt. șurubelniță
E Puntă de destornilladora
CN 固定深度旋具头



- with limiter
- z ogranicznikiem

COLOR BOX



| YATO | L (mm) | ⊖ (mm) | PCS packing | 📦 |
|---------|--------|---------------|-------------|-------|
| YT-7980 | 25 | 1/4" (6.3 mm) | 20 | 20/40 |

GB Screwdriver bit
D Schraubendreherbit
PL Końcówka śrubokrętowa

RUS Бит крестовая
CZ Šroubováková koncovka
H Csavarhúzóvég

RO Capăt pt. șurubelniță
E Punta de destornillador
CN 旋具头组套

SLIDING
CARD



2
PCS

1/4"
(6.3mm)

S2

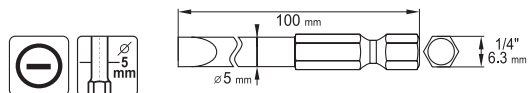

| YATO | ⊖ | L (mm) | ⊘ | 📦 |
|---------|-----|--------|---------------|--------|
| YT-0484 | 4.0 | 100 | 1/4" (6.3 mm) | 25/100 |
| | 5.0 | 100 | | |

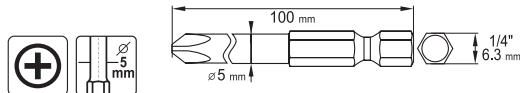

| YATO | ⊕ | L (mm) | ⊘ | 📦 |
|---------|------|--------|---------------|--------|
| YT-0459 | PH00 | 100 | 1/4" (6.3 mm) | 25/100 |
| | PH0 | 100 | | |

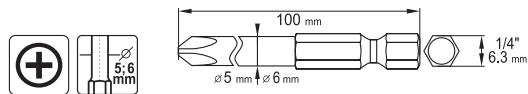

| YATO | ⊕ | L (mm) | ⊘ | 📦 |
|---------|-----|--------|---------------|--------|
| YT-0488 | PH1 | 100 | 1/4" (6.3 mm) | 25/100 |
| | PH2 | 100 | | |

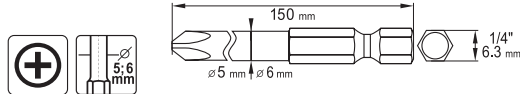
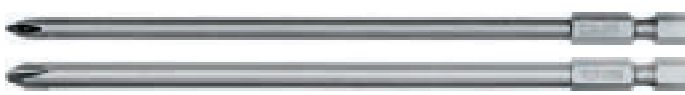

| YATO | ⊕ | L (mm) | ⊘ | 📦 |
|---------|-----|--------|---------------|--------|
| YT-0489 | PH1 | 150 | 1/4" (6.3 mm) | 25/100 |
| | PH2 | 150 | | |

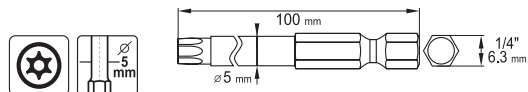

| YATO | ⊗ | L (mm) | ⊘ | 📦 |
|---------|-----|--------|---------------|--------|
| YT-0490 | T10 | 100 | 1/4" (6.3 mm) | 25/100 |
| | T25 | 100 | | |

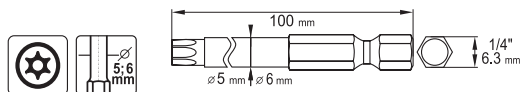

| YATO | ⊗ | L (mm) | ⊘ | 📦 |
|---------|-----|--------|---------------|--------|
| YT-0491 | T15 | 100 | 1/4" (6.3 mm) | 25/100 |
| | T27 | 100 | | |
| YT-0492 | T20 | 100 | 1/4" (6.3 mm) | 25/100 |
| | T30 | 100 | | |

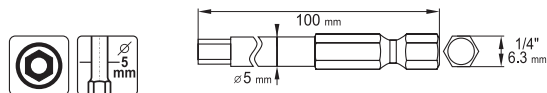

| YATO | ⊗ | L (mm) | ⊘ | 📦 |
|---------|-----|--------|---------------|--------|
| YT-0494 | 3.0 | 100 | 1/4" (6.3 mm) | 25/100 |
| | 5.0 | 100 | | |

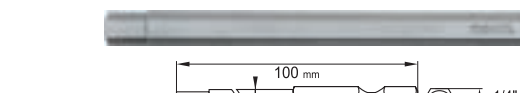
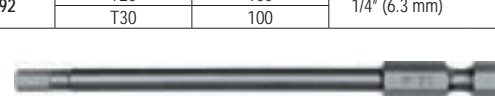

| YATO | ⊗ | L (mm) | ⊘ | 📦 |
|---------|-----|--------|---------------|--------|
| YT-0495 | 4.0 | 100 | 1/4" (6.3 mm) | 25/100 |
| | 6.0 | 100 | | |

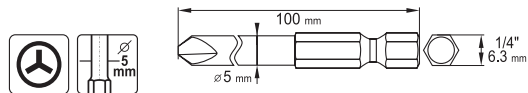

| YATO | ⊗ | L (mm) | ⊘ | 📦 |
|---------|----|--------|---------------|--------|
| YT-0493 | #0 | 100 | 1/4" (6.3 mm) | 25/100 |
| | #1 | 100 | | |
| YT-0496 | #1 | 100 | 1/4" (6.3 mm) | 25/100 |
| | #3 | 100 | | |

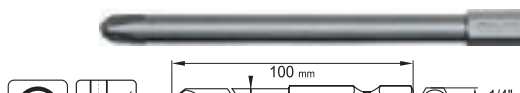
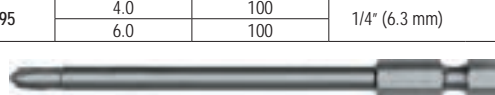

| YATO | ⊗ | L (mm) | ⊘ | 📦 |
|---------|----|--------|---------------|--------|
| YT-0497 | #2 | 100 | 1/4" (6.3 mm) | 25/100 |
| | #4 | 100 | | |

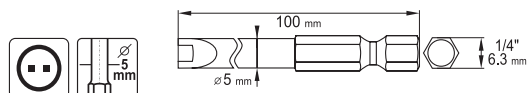

| YATO | ⊗ | L (mm) | ⊘ | 📦 |
|---------|----|--------|---------------|--------|
| YT-0498 | #4 | 100 | 1/4" (6.3 mm) | 25/100 |
| | #8 | 100 | | |

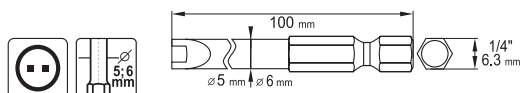

| YATO | ⊗ | L (mm) | ⊘ | 📦 |
|---------|-----|--------|---------------|--------|
| YT-0499 | #6 | 100 | 1/4" (6.3 mm) | 25/100 |
| | #10 | 100 | | |

GB Screwdriver bit set
D Schraubendreherbitsatz
PL Zestaw końcówek śrubokrętowych
RUS Набор специальных битов
CZ Sada bitů
H Bitkészlet
RO Truse bit
E Juego de llaves especiales
CN 旋具头组套



21.8 Nm max. AISI S2 HRC 58-62

40 PCS HEX SPLINE TORX

METAL CASE & COLOR BOX



○ x14: L=30 mm: H4, H5, H6, H7, H8, H10, H12; L=75 mm: H4, H5, H6, H7, H8, H10, H12; AISI S2;
○ x10: L=30 mm: M5, M6, M8, M10, M12; L=75 mm: M5, M6, M8, M10, M12; AISI S2;
⊕ x14: L=30 mm: T20, T25, T30, T40, T45, T50, T55; L=75 mm: T20, T25, T30, T40, T45, T50, T55; AISI S2;
⊕ x2: 1/2" (12.7 mm): 10 mm, 3/8" (9.5 mm): 10 mm; CrV 6150

YATO YT-0400 10



7 PCS TORX

⊕ x6: L=30 mm: T25, T30, T40, T45, T50, T55; AISI S2;
⊕ 1/2" (12.7 mm): 10 mm; CrV 6150

HANGING COLOR BOX

YATO YT-0410 24/72



⊕ x14: L=30 mm: T20, T25, T30, T40, T45, T50, T55; L=75 mm: T20, T25, T30, T40, T45, T50, T55; AISI S2;
⊕ 1/2" (12.7 mm): 10 mm; CrV 6150

15 PCS TORX

METAL CASE & COLOR BOX



YATO YT-0411 20



7 PCS HEX

○ x6: L=30 mm: H4, H5, H6, H8, H10, H12 mm; AISI S2;
⊕ 1/2" (12.7 mm): 10 mm; CrV 6150

HANGING COLOR BOX

YATO YT-0412 24/72



○ x14: L=30 mm: H4, H5, H6, H7, H8, H10, H12 mm; L=75 mm: H4, H5, H6, H7, H8, H10, H12 mm; AISI S2;
⊕ 1/2" (12.7 mm): 10 mm; CrV 6150

15 PCS HEX

METAL CASE & COLOR BOX



YATO YT-0413 20



6 PCS SPLINE

○ x5: L=30 mm: M5, M6, M8, M10, M12; AISI S2;
⊕ 1/2" (12.7 mm): 10 mm; CrV 6150

HANGING COLOR BOX

YATO YT-0414 24/72



○ x10: L=30 mm: M5, M6, M8, M10, M12; L=75 mm: M5, M6, M8, M10, M12; AISI S2;
⊕ 1/2" (12.7 mm): 10 mm; CrV 6150

11 PCS SPLINE

METAL CASE & COLOR BOX



YATO YT-0415 20



7 PCS TORX TAMPERPROOF

⊕ x6: L=30 mm: T25, T30, T40, T45, T50, T55; AISI S2;
⊕ 1/2" (12.7 mm): 10 mm; CrV 6150

HANGING COLOR BOX

YATO YT-0416 24/72



⊕ x14: L=30 mm: T20, T25, T30, T40, T45, T50, T55; L=75 mm: T20, T25, T30, T40, T45, T50, T55; AISI S2;
⊕ 1/2" (12.7 mm): 10 mm; CrV 6150

15 PCS TORX TAMPERPROOF

METAL CASE & COLOR BOX



YATO YT-0417 20



8 PCS RIBE

⊕ x7: L=30 mm: M5, M6, M7, M8, M10, M12, M14; AISI S2;
⊕ 1/2" (12.7 mm): 10 mm; CrV 6150

HANGING COLOR BOX

YATO YT-0418 24/72

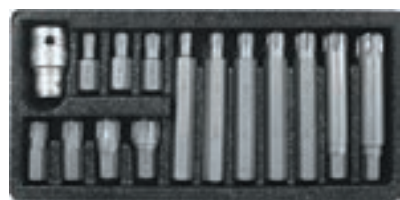

⊕ x14: L=30 mm: M6, M7, M8, M9, M10, M12, M14; L=75 mm: M6, M7, M8, M9, M10, M12, M14; AISI S2;
⊕ 1/2" (12.7 mm): 10 mm; CrV 6150

15 PCS RIBE

METAL CASE & COLOR BOX



YATO YT-0419 20



42 PCS RIBE TORX TAMPERPROOF

⊕ x18: L=30 mm: T20, T25, T30, T40, T45, T50, T55, T60, T70; AISI S2; L=75 mm: T20, T25, T30, T40, T45, T50, T55, T60, T70; AISI S2;
⊕ x22: L=30 mm: M4, M5, M6, M7, M8, M9, M10, M11, M12, M13, M14; AISI S2; L=75 mm: M4, M5, M6, M7, M8, M9, M10, M11, M12, M13, M14; AISI S2;
⊕ x2: 1/2" (12.7 mm): 10 mm, 3/8" (9.5 mm): 10 mm; CrV 6150

METAL CASE & COLOR BOX



YATO YT-0420 10

- GB Nut setter
 D Magnet-Steckschlüssel mit Adapter
 PL Nasadka magnetyczna do wkrętarki
 RUS Магнитная головка для винтовёрта
 CZ Nástrčný kľúč magnetický do vrtačky
 H Csavarbehajtó
 RO Cheie tubulara cu prindere tip mandrina
 E Boquilla magnética de destornilladora
 CN 磁性套筒



L(mm) **48** **CrV 6150**



| YATO | Hex | PCS packing | Box |
|---------|-----|-------------|---------|
| YT-1501 | 6 | 20 | 200/600 |
| YT-1502 | 7 | 20 | 200/600 |
| YT-1503 | 8 | 20 | 200/600 |
| YT-1505 | 10 | 20 | 200/600 |
| YT-1507 | 12 | 20 | 200/600 |
| YT-1508 | 13 | 20 | 200/600 |

| YATO | Hex | Box |
|---------|-----|---------|
| YT-1511 | 6 | 100/200 |
| YT-1512 | 7 | 100/200 |
| YT-1513 | 8 | 100/200 |
| YT-1515 | 10 | 100/200 |
| YT-1517 | 12 | 100/200 |
| YT-1518 | 13 | 100/200 |

- GB Screwdriver bit holder
 D Bithalter
 PL Uchwyt do końcówek śrubokrętowych
 RUS Магнитный держатель
 CZ Držák na šroubovavkovékoncovky
 H Szár a csavarhúzóvégkehez
 RO Capete şurubelniţă
 E Mandril para puntas
 CN 旋具磁性接杆

SLIDING CARD **1/4" 6.3mm**



| YATO | Hex | L (mm) | Box |
|---------|---------------|--------|--------|
| YT-0465 | 1/4" (6.3 mm) | 60 | 20/200 |

| YATO | Hex | L (mm) | Box |
|---------|---------------|--------|--------|
| YT-0466 | 1/4" (6.3 mm) | 60 | 20/200 |



| YATO | Hex | L (mm) | Box |
|---------|---------------|--------|--------|
| YT-0467 | 1/4" (6.3 mm) | 80 | 20/200 |

| YATO | Hex | L (mm) | Box |
|---------|---------------|--------|--------|
| YT-0468 | 1/4" (6.3 mm) | 60 | 20/200 |

- GB Hex with ball with handle
 D Aufsteckschlüssel
 PL Klucz trzpieniowy z rączką
 RUS Ключ торцевой
 CZ Šerový kľúč
 H Csapkulcs
 RO Chei cu cozi
 E Llave de mandril
 CN 球头内六角螺丝批

SVCM **55** **HRC 55-59**

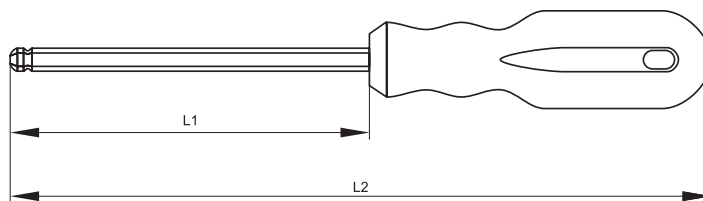

COLOR BOX



| YATO | Hex (mm) | L1 (mm) | L2 (mm) | PCS packing | Box |
|---------|----------|---------|---------|-------------|-----|
| YT-1530 | 2.0 | 75 | 175 | 12 | 240 |
| YT-1531 | 2.5 | 75 | 175 | 12 | 240 |
| YT-1532 | 3.0 | 100 | 200 | 12 | 240 |
| YT-1533 | 4.0 | 100 | 205 | 12 | 240 |

| YATO | Hex (mm) | L1 (mm) | L2 (mm) | PCS packing | Box |
|---------|----------|---------|---------|-------------|-----|
| YT-1534 | 5.0 | 100 | 205 | 12 | 240 |
| YT-1535 | 6.0 | 125 | 242 | 12 | 240 |
| YT-1537 | 8.0 | 150 | 278 | 6 | 120 |
| YT-1539 | 10.0 | 150 | 278 | 6 | 120 |

GB Hex key
D Sechskant-Stiftschlüssel
PL Klucz sześciokątny
RUS Шестигранник
CZ Imbusový klíč
H Imbisz kulcs
RO Cheie imbus
E Llave hexagonal
CN 内六角扳手

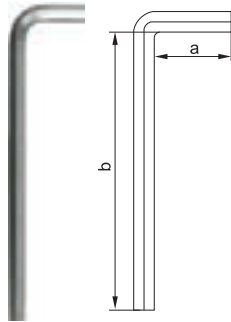

HEX CrV 6150 HRC 52-55

| YATO | Ø (mm) | a (mm) | b (mm) | PCS packing |
|---------|--------|--------|--------|-------------|
| YT-0546 | 6 | 24 | 110 | 20/200 |

GB Hex key
D Sechskant-Stiftschlüssel
PL Klucz sześciokątny

RUS Шестигранник
CZ Imbusový klíč
H Imbisz kulcs

RO Cheie imbus
E Llave hexagonal
CN 内六角扳手

POUCH



CrV 6150

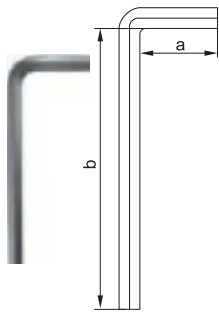

| YATO | Ø (mm) | a (mm) | b (mm) | PCS packing |
|---------|--------|--------|--------|-------------|
| YT-5730 | 1.5 | 13 | 45 | 12 20/80 |
| YT-5737 | 7.0 | 34 | 95 | 6 20/40 |

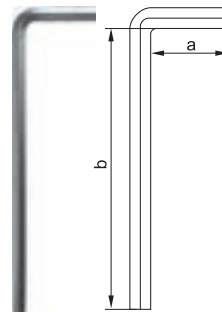

| YATO | Ø (mm) | a (mm) | b (mm) | PCS packing |
|---------|--------|--------|--------|-------------|
| YT-5740 | 1.5 | 13 | 61 | 12 20/80 |
| YT-5741 | 2.0 | 15 | 75 | 12 20/80 |

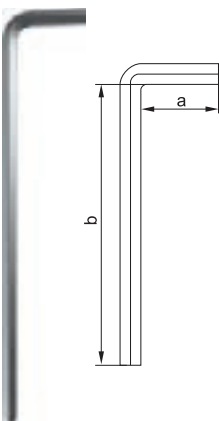

| YATO | Ø (mm) | a (mm) | b (mm) | PCS packing |
|---------|--------|--------|--------|-------------|
| YT-5760 | 1.5 | 14 | 89 | 12 20/80 |
| YT-5761 | 2.0 | 16 | 99 | 12 20/80 |
| YT-5763 | 3.0 | 19 | 124 | 12 20/80 |
| YT-5767 | 7.0 | 32 | 186 | 6 10/20 |
| YT-5768 | 8.0 | 34 | 197 | 6 10/20 |
| YT-5769 | 10.0 | 38 | 221 | 6 10/20 |

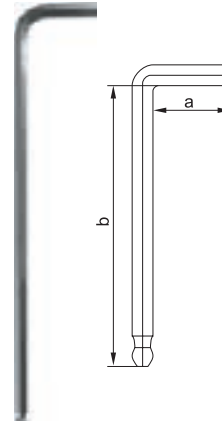

| YATO | Ø (mm) | a (mm) | b (mm) | PCS packing |
|---------|----------------|--------|--------|-------------|
| YT-5770 | 1/16" (1.6 mm) | 14 | 90 | 12 20/80 |
| YT-5771 | 5/64" (2.0 mm) | 16 | 100 | 12 20/80 |
| YT-5772 | 3/32" (2.4 mm) | 17 | 111 | 12 20/80 |
| YT-5773 | 7/64" (2.8 mm) | 18 | 116 | 12 20/80 |
| YT-5774 | 1/8" (3.2 mm) | 19 | 123 | 12 20/80 |
| YT-5775 | 9/64" (3.6 mm) | 20 | 130 | 12 20/80 |
| YT-5777 | 3/16" (4.8 mm) | 24 | 151 | 6 10/20 |
| YT-5778 | 7/32" (5.6 mm) | 25 | 165 | 6 10/20 |
| YT-5779 | 1/4" (6.3 mm) | 28 | 183 | 6 10/20 |
| YT-5780 | 5/16" (7.9 mm) | 32 | 202 | 6 10/20 |
| YT-5781 | 3/8" (9.5 mm) | 35 | 233 | 6 10/20 |

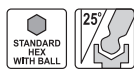
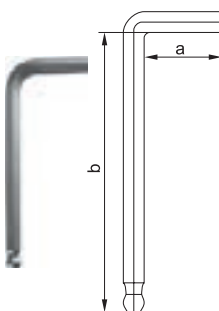

| YATO | Ø (mm) | a (mm) | b (mm) | PCS packing |
|---------|--------|--------|--------|-------------|
| YT-5785 | 1.5 | 13 | 45 | 12 20/80 |
| YT-5786 | 2.0 | 15 | 49 | 12 20/80 |
| YT-5787 | 2.5 | 17 | 56 | 12 20/80 |
| YT-5788 | 3.0 | 19 | 62 | 12 20/80 |
| YT-5791 | 6.0 | 30 | 91 | 6 20/40 |
| YT-5792 | 7.0 | 32 | 95 | 6 20/40 |
| YT-5793 | 8.0 | 34 | 98 | 6 20/40 |
| YT-5794 | 10.0 | 37 | 111 | 6 20/40 |

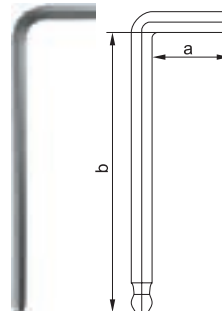

| YATO | Ø (mm) | a (mm) | b (mm) | PCS packing |
|---------|--------|--------|--------|-------------|
| YT-5795 | 1.5 | 13 | 62 | 12 20/80 |
| YT-5796 | 2.0 | 15 | 75 | 12 20/80 |
| YT-5797 | 2.5 | 17 | 85 | 12 20/80 |
| YT-5798 | 3.0 | 19 | 89 | 12 20/80 |
| YT-5801 | 6.0 | 29 | 135 | 6 20/40 |
| YT-5802 | 7.0 | 33 | 140 | 6 20/40 |
| YT-5803 | 8.0 | 34 | 150 | 6 20/40 |
| YT-5804 | 10.0 | 36 | 172 | 6 20/40 |

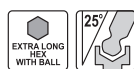
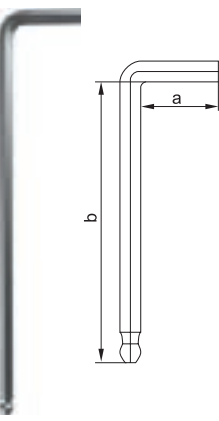

| YATO | Ø (mm) | a (mm) | b (mm) | PCS packing |
|---------|--------|--------|--------|-------------|
| YT-5805 | 1.5 | 14 | 89 | 12 20/80 |
| YT-5806 | 2.0 | 15 | 99 | 12 20/80 |
| YT-5807 | 2.5 | 18 | 110 | 12 20/80 |
| YT-5808 | 3.0 | 20 | 124 | 12 20/80 |
| YT-5810 | 5.0 | 26 | 158 | 6 20/80 |
| YT-5812 | 7.0 | 31 | 187 | 6 10/20 |
| YT-5813 | 8.0 | 34 | 198 | 6 10/20 |
| YT-5814 | 10.0 | 38 | 220 | 6 10/20 |

- GB TORX key
- D TORX-Stiftschlüssel
- PL Klucz TORX
- RUS Ключ TORX
- CZ Klíč TORX
- H Kulcs TORX
- RO Cheie TORX
- E Llave TORX
- CN 内六角扳手

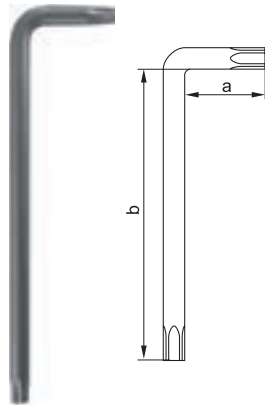

POUCH



CrV
6150

| YATO | ⊙ | a (mm) | b (mm) | PCS packing: | |
|---------|-----|--------|--------|--------------|-------|
| YT-5820 | T6 | 16 | 69 | 12 | 20/80 |
| YT-5821 | T7 | 16 | 73 | 12 | 20/80 |
| YT-5822 | T8 | 16 | 77 | 12 | 20/80 |
| YT-5823 | T9 | 16 | 81 | 12 | 20/80 |
| YT-5824 | T10 | 17 | 86 | 12 | 20/80 |
| YT-5828 | T27 | 22 | 104 | 6 | 20/80 |
| YT-5831 | T45 | 27 | 135 | 6 | 20/40 |
| YT-5832 | T50 | 32 | 155 | 6 | 20/40 |
| YT-5833 | T55 | 35 | 164 | 6 | 20/40 |

5

- GB Hex key set
- RUS Набор шестигранников
- RO Chei imbus
- D Sechskant-Stiftschlüsselsatz
- CZ Imbusové klíče
- E Juego de llaves hex
- PL Zestaw kluczy imbusowych
- H Imbisz kulcs
- CN 内六角扳手组套

PLASTIC HANGER & SLIDING CARD



12
PCS

CrV
6150

S.A.E.

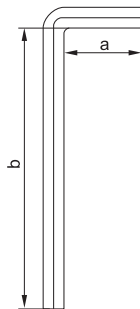

| YATO | ⊙ | a (mm) | b (mm) | |
|---------------|----------------|--------|--------|------|
| YT-5835 | 1/16" (1.6 mm) | 14 | 74 | 6/36 |
| | 5/64" (2.0 mm) | 16 | 79 | |
| | 3/32" (2.4 mm) | 17 | 83 | |
| | 7/64" (2.8 mm) | 18 | 88 | |
| | 1/8" (3.2 mm) | 19 | 93 | |
| | 9/64" (3.6 mm) | 20 | 99 | |
| | 5/32" (4.0 mm) | 21 | 105 | |
| | 3/16" (4.8 mm) | 24 | 113 | |
| | 7/32" (5.6 mm) | 25 | 122 | |
| | 1/4" (6.3 mm) | 28 | 132 | |
| | 5/16" (7.9 mm) | 32 | 150 | |
| 3/8" (9.5 mm) | 35 | 170 | | |

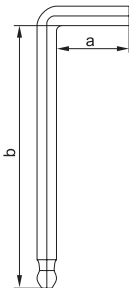

| YATO | ⊙ | a (mm) | b (mm) | |
|---------------|----------------|--------|--------|------|
| YT-5837 | 1/16" (1.6 mm) | 14 | 74 | 6/36 |
| | 5/64" (2.0 mm) | 16 | 79 | |
| | 3/32" (2.4 mm) | 17 | 83 | |
| | 7/64" (2.8 mm) | 18 | 88 | |
| | 1/8" (3.2 mm) | 19 | 93 | |
| | 9/64" (3.6 mm) | 20 | 99 | |
| | 5/32" (4.0 mm) | 21 | 105 | |
| | 3/16" (4.8 mm) | 24 | 113 | |
| | 7/32" (5.6 mm) | 25 | 122 | |
| | 1/4" (6.3 mm) | 28 | 132 | |
| | 5/16" (7.9 mm) | 32 | 150 | |
| 3/8" (9.5 mm) | 35 | 170 | | |



| YATO | ⊙ | a (mm) | b (mm) | |
|---------------|----------------|--------|--------|------|
| YT-5838 | 1/16" (1.6 mm) | 14 | 91 | 6/36 |
| | 5/64" (2.0 mm) | 16 | 100 | |
| | 3/32" (2.4 mm) | 17 | 110 | |
| | 7/64" (2.8 mm) | 18 | 116 | |
| | 1/8" (3.2 mm) | 19 | 123 | |
| | 9/64" (3.6 mm) | 20 | 130 | |
| | 5/32" (4.0 mm) | 21 | 132 | |
| | 3/16" (4.8 mm) | 24 | 150 | |
| | 7/32" (5.6 mm) | 25 | 165 | |
| | 1/4" (6.3 mm) | 28 | 185 | |
| | 5/16" (7.9 mm) | 32 | 200 | |
| 3/8" (9.5 mm) | 35 | 233 | | |

GB Hex key set
D Sechskant-Stiftschlüsselsatz
PL Zestaw kluczy imbusowych

RUS Набор шестигранников
CZ Imbusové klíče
H Imbisz kulcs

RO Chei imbus
E Juego de llaves hex
CN 内六角扳手组套

PLASTIC HANGER
& SLIDING CARD



HEX CrV 6150 HRC 52-55

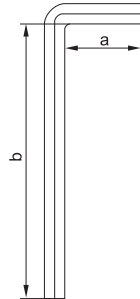

9
PCS

| YATO | Ø (mm) | a (mm) | b (mm) | |
|---------|--------|--------|--------|------|
| YT-0500 | 1.5 | 15 | 74 | 6/36 |
| | 2.0 | 16 | 81 | |
| | 2.5 | 18 | 88 | |
| | 3.0 | 21 | 95 | |
| | 4.0 | 23 | 109 | |
| | 5.0 | 28 | 121 | |
| | 6.0 | 31 | 135 | |
| | 8.0 | 35 | 157 | |
| | 10.0 | 39 | 174 | |

9
PCS

| YATO | Ø (mm) | a (mm) | b (mm) | |
|---------|--------|--------|--------|------|
| YT-0501 | 1.5 | 15 | 90 | 6/36 |
| | 2.0 | 16 | 96 | |
| | 2.5 | 18 | 112 | |
| | 3.0 | 21 | 125 | |
| | 4.0 | 23 | 142 | |
| | 5.0 | 28 | 157 | |
| | 6.0 | 31 | 180 | |
| | 8.0 | 35 | 201 | |
| | 10.0 | 39 | 225 | |

9
PCS

| YATO | Ø (mm) | a (mm) | b (mm) | |
|---------|--------|--------|--------|------|
| YT-0502 | 2.0 | 16 | 81 | 6/36 |
| | 2.5 | 18 | 88 | |
| | 3.0 | 21 | 95 | |
| | 4.0 | 23 | 109 | |
| | 5.0 | 28 | 121 | |
| | 6.0 | 31 | 135 | |
| | 7.0 | 33 | 145 | |
| | 8.0 | 35 | 157 | |
| | 10.0 | 39 | 174 | |

10
PCS

| YATO | Ø (mm) | a (mm) | b (mm) | |
|---------|--------|--------|--------|------|
| YT-0508 | 2.0 | 16 | 81 | 6/36 |
| | 2.5 | 18 | 88 | |
| | 3.0 | 21 | 95 | |
| | 4.0 | 23 | 109 | |
| | 5.0 | 28 | 121 | |
| | 6.0 | 31 | 135 | |
| | 7.0 | 33 | 145 | |
| | 8.0 | 35 | 157 | |
| | 10.0 | 39 | 174 | |
| | 12.0 | 42 | 180 | |

9
PCS

| YATO | Ø (mm) | a (mm) | b (mm) | |
|---------|--------|--------|--------|------|
| YT-0505 | 1.5 | 15 | 74 | 6/36 |
| | 2.0 | 16 | 81 | |
| | 2.5 | 18 | 88 | |
| | 3.0 | 21 | 95 | |
| | 4.0 | 23 | 109 | |
| | 5.0 | 28 | 121 | |
| | 6.0 | 31 | 135 | |
| | 8.0 | 35 | 157 | |
| | 10.0 | 39 | 174 | |

9
PCS

| YATO | Ø (mm) | a (mm) | b (mm) | |
|---------|--------|--------|--------|------|
| YT-0506 | 1.5 | 15 | 90 | 6/36 |
| | 2.0 | 16 | 96 | |
| | 2.5 | 18 | 112 | |
| | 3.0 | 21 | 125 | |
| | 4.0 | 23 | 142 | |
| | 5.0 | 28 | 157 | |
| | 6.0 | 31 | 180 | |
| | 8.0 | 35 | 201 | |
| | 10.0 | 39 | 225 | |

9
PCS

| YATO | Ø (mm) | a (mm) | b (mm) | |
|---------|--------|--------|--------|------|
| YT-0507 | 2.0 | 16 | 81 | 6/36 |
| | 2.5 | 18 | 88 | |
| | 3.0 | 21 | 95 | |
| | 4.0 | 23 | 109 | |
| | 5.0 | 28 | 121 | |
| | 6.0 | 31 | 135 | |
| | 7.0 | 33 | 145 | |
| | 8.0 | 35 | 157 | |
| | 10.0 | 39 | 174 | |

10
PCS

| YATO | Ø (mm) | a (mm) | b (mm) | |
|---------|--------|--------|--------|------|
| YT-0509 | 2.0 | 16 | 81 | 6/36 |
| | 2.5 | 18 | 88 | |
| | 3.0 | 21 | 95 | |
| | 4.0 | 23 | 109 | |
| | 5.0 | 28 | 121 | |
| | 6.0 | 31 | 135 | |
| | 7.0 | 33 | 145 | |
| | 8.0 | 35 | 157 | |
| | 10.0 | 39 | 174 | |
| | 12.0 | 42 | 180 | |

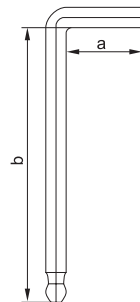

GB Hex key set
D Sechskant-Stiftschlüsselsatz
PL Zestaw kluczy imbusowych

RUS Набор шестигранников
CZ Imbusové klíče
H Imbisz kulcs

RO Chei imbus
E Juego de llaves hex
CN 内六角扳手组套

POUCH



HEX CrV 6150

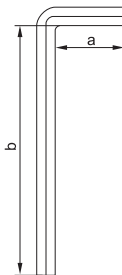

8
PCS

| YATO | Ø (mm) | a (mm) | b (mm) | |
|---------|--------|--------|--------|-------|
| YT-0503 | 2.0 | 14 | 50 | 12/72 |
| | 2.5 | 16 | 53 | |
| | 3.0 | 17 | 60 | |
| | 4.0 | 21 | 66 | |
| | 5.0 | 22 | 74 | |
| | 6.0 | 27 | 81 | |
| | 8.0 | 32 | 93 | |
| | 10.0 | 38 | 104 | |

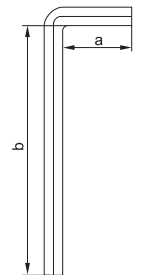

10
PCS

| YATO | Ø (mm) | a (mm) | b (mm) | |
|---------|--------|--------|--------|-------|
| YT-0504 | 1.5 | 12 | 43 | 12/72 |
| | 2.0 | 14 | 50 | |
| | 2.5 | 16 | 53 | |
| | 3.0 | 17 | 60 | |
| | 4.0 | 21 | 66 | |
| | 5.0 | 22 | 74 | |
| | 6.0 | 27 | 81 | |
| | 7.0 | 31 | 86 | |
| | 8.0 | 32 | 93 | |
| | 10.0 | 38 | 104 | |

GB Hex key set
 D Sechskant-Stiftschlüsselsatz
 PL Zestaw kluczy imbusowych
 RUS Набор шестигранников
 CZ Imbusové klíče
 H Imbisz kulcs
 RO Chei imbus
 E Juego de llaves hex
 CN 内六角扳手组套



10
PCS



CrV
6150

HRC
52-55

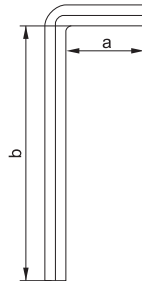

| YATO | Ø (mm) | a (mm) | b (mm) | |
|---------|--------|--------|--------|---|
| YT-0519 | 3.0 | 20 | 125 | 5 |
| | 4.0 | 25 | 140 | |
| | 5.0 | 28 | 160 | |
| | 5.5 | 30 | 170 | |
| | 6.0 | 32 | 180 | |
| | 8.0 | 35 | 200 | |
| | 10.0 | 42 | 220 | |
| | 12.0 | 49 | 250 | |
| | 14.0 | 57 | 285 | |
| 17.0 | 65 | 320 | | |

GB TORX key set
 D TORX-Stiftschlüsselsatz
 PL Zestaw kluczy TORX
 RUS Набор ключей TORX
 CZ Souprava klíčů TORX
 H Kulcskészlet, TORX
 RO Set de chei TORX
 E Juego de llaves TORX
 CN 内六角扳手组套

PLASTIC
HANGER
& SLIDING
CARD

9
PCS



CrV
6150

HRC
52-55

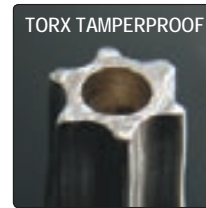
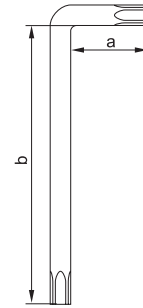

| YATO | Ø | a (mm) | b (mm) | |
|---------|-----|--------|--------|------|
| YT-0511 | T10 | 15 | 72 | 6/36 |
| | T15 | 16 | 79 | |
| | T20 | 17 | 86 | |
| | T25 | 21 | 94 | |
| | T27 | 24 | 107 | |
| | T30 | 27 | 122 | |
| | T40 | 32 | 133 | |
| | T45 | 36 | 155 | |
| | T50 | 38 | 174 | |

| YATO | Ø | a (mm) | b (mm) | |
|---------|-----|--------|--------|------|
| YT-0512 | T10 | 15 | 78 | 6/36 |
| | T15 | 16 | 95 | |
| | T20 | 19 | 109 | |
| | T25 | 23 | 124 | |
| | T27 | 26 | 143 | |
| | T30 | 27 | 153 | |
| | T40 | 32 | 180 | |
| | T45 | 36 | 200 | |
| | T50 | 41 | 222 | |

GB Hex key set
 D Sechskant-Stiftschlüsselsatz
 PL Zestaw kluczy imbusowych
 RUS Набор шестигранников
 CZ Imbusové klíče

H Imbisz kulcs
 RO Chei imbus
 E Juego de llaves hex
 CN 内六角组套

PLASTIC
HANGER



S2

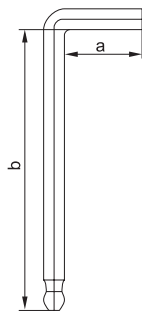

10
PCS

10
PCS

| YATO | Ø (mm) | a (mm) | b (mm) | |
|---------|--------|--------|--------|-------|
| YT-0560 | 1.27 | 12 | 73 | 12/48 |
| | 1.5 | 14 | 76 | |
| | 2.0 | 16 | 82 | |
| | 2.5 | 18 | 89 | |
| | 3.0 | 18 | 99 | |
| | 4.0 | 21 | 104 | |
| | 5.0 | 27 | 115 | |
| | 6.0 | 32 | 138 | |
| | 8.0 | 35 | 161 | |
| | 10.0 | 38 | 179 | |

| YATO | Ø (mm) | a (mm) | b (mm) | |
|---------|--------|--------|--------|-------|
| YT-0561 | 1.27 | 10 | 78 | 12/48 |
| | 1.5 | 12 | 89 | |
| | 2.0 | 15 | 98 | |
| | 2.5 | 17 | 110 | |
| | 3.0 | 19 | 124 | |
| | 4.0 | 23 | 140 | |
| | 5.0 | 28 | 159 | |
| | 6.0 | 32 | 179 | |
| | 8.0 | 36 | 198 | |
| | 10.0 | 50 | 232 | |

GB TORX key set
 D TORX-Stiftschlüsselsatz
 PL Zestaw kluczy TORX
 RUS Набор ключей TORX
 CZ Souprava klíčů TORX
 H Kulcskészlet, TORX
 RO Set de chei TORX
 E Juego de llaves TORX
 CN 内六角扳手组套

TORX TAMPERPROOF

PLASTIC
HANGER



S2

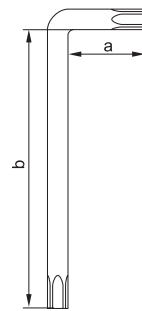

7
PCS

9
PCS

| YATO | Ø | a (mm) | b (mm) | |
|---------|-----|--------|--------|-------|
| YT-0562 | T9 | 18 | 78 | 12/48 |
| | T10 | 19 | 85 | |
| | T15 | 19 | 93 | |
| | T20 | 19 | 103 | |
| | T25 | 22 | 113 | |
| | T27 | 24 | 123 | |
| | T30 | 26 | 132 | |

| YATO | Ø | a (mm) | b (mm) | |
|---------|-----|--------|--------|-------|
| YT-0563 | T10 | 14 | 87 | 12/48 |
| | T15 | 14 | 97 | |
| | T20 | 16 | 108 | |
| | T25 | 18 | 123 | |
| | T27 | 23 | 137 | |
| | T30 | 27 | 158 | |
| | T40 | 30 | 177 | |
| | T45 | 35 | 197 | |
| | T50 | 41 | 216 | |

Memo

6

Pliers & pipe wrenches Szczypce i klucze do rur



| | | |
|--|---|-----|
| Pliers, CrV Szczypce, CrV |  | 115 |
|--|---|-----|

| | |
|---|-----|
| Combination pliers Szczypce uniwersalne..... | 115 |
| Side cutting pliers Szczypce tnące, boczne..... | 115 |
| Long nose pliers Szczypce wydłużone, proste..... | 115 |
| Bent nose pliers Szczypce wydłużone, wygięte..... | 115 |

| | | |
|----------------------------------|---|---------|
| Pliers Szczypce |  | 115-116 |
|----------------------------------|---|---------|

| | |
|---|-----|
| Combination pliers Szczypce uniwersalne..... | 115 |
| Side cutting pliers Szczypce tnące, boczne..... | 115 |
| Long nose pliers Szczypce wydłużone, proste..... | 115 |
| Bent nose pliers Szczypce wydłużone, wygięte..... | 115 |
| Flat nose pliers Szczypce płaskie..... | 116 |
| Round nose pliers Szczypce okrągłe..... | 116 |
| Wire stripping pliers Szczypce do ściągania izolacji..... | 116 |
| End cutting pliers Szczypce tnące, czołowe..... | 116 |

| | | |
|--|---|-----|
| Pliers, CrV Szczypce, CrV |  | 116 |
|--|---|-----|

| | |
|---|-----|
| Combination pliers Szczypce uniwersalne..... | 116 |
| Side cutting pliers Szczypce tnące, boczne..... | 116 |

| | | |
|----------------------------------|---|-----|
| Pliers Szczypce |  | 117 |
|----------------------------------|---|-----|

| | |
|--|-----|
| Combination pliers Szczypce uniwersalne..... | 117 |
| Side cutting pliers Szczypce tnące, boczne..... | 117 |
| Long nose pliers Szczypce wydłużone, proste..... | 117 |

| | | |
|--|---|-----|
| Mini pliers Szczypce „Mini” |  | 118 |
|--|---|-----|

| | |
|---|-----|
| Combination pliers Szczypce uniwersalne..... | 118 |
| Side cutting pliers Szczypce tnące, boczne..... | 118 |
| Long nose pliers Szczypce wydłużone, proste..... | 118 |
| Bent nose pliers Szczypce wydłużone, wygięte..... | 118 |
| Flat nose pliers Szczypce płaskie..... | 118 |
| Round nose pliers Szczypce okrągłe..... | 118 |

| | |
|---|-----|
| End cutting pliers Szczypce tnące, czołowe..... | 118 |
|---|-----|

| | | |
|--|---|-----|
| Pliers, CrV Szczypce, CrV |  | 119 |
|--|---|-----|

| | |
|--|-----|
| Combination pliers Szczypce uniwersalne..... | 119 |
| Side cutting pliers Szczypce tnące, boczne..... | 119 |
| Long nose pliers Szczypce wydłużone, proste..... | 119 |
| End cutting pliers Szczypce tnące, czołowe..... | 119 |

| | | |
|--|---|-----|
| Insulated pliers Szczypce izolowane |  | 120 |
|--|---|-----|

| | |
|---|-----|
| Combination pliers Szczypce uniwersalne..... | 120 |
| Side cutting pliers Szczypce tnące, boczne..... | 120 |
| Long nose pliers Szczypce wydłużone, proste..... | 120 |
| Bent nose pliers Szczypce wydłużone, wygięte..... | 120 |
| Wire stripping pliers Szczypce do ściągania izolacji..... | 120 |

| | | |
|---|---|-----|
| Plastics & cables cutting pliers Szczypce do cięcia plastiku i kabli |  | 121 |
|---|---|-----|

| | |
|--|-----|
| Side cutting pliers Szczypce tnące, boczne..... | 121 |
| Long nose pliers Szczypce wydłużone, proste..... | 121 |

| | | |
|---|---|-----|
| Carpenter's pliers & tower pincers Obcęgi i szczypce |  | 122 |
|---|---|-----|

| | |
|--|-----|
| Carpenter's pliers Obcęgi..... | 122 |
| Tower pincers Szczypce tynkarskie..... | 122 |

| | | |
|--|---|-----|
| Heavy duty side cutting pliers Szczypce tnące, boczne |  | 122 |
|--|---|-----|

| | | |
|---|---|-----|
| End cutting pliers Szczypce tnące czołowe |  | 122 |
|---|---|-----|

| | | |
|---|---|---------|
| Circlip pliers Szczypce Segera |  | 123-124 |
|---|---|---------|



Lock grip pliers
Szczypce zaciskowe

125-127



Pipe wrenches
Klucze do rur

128



Lock grip pliers

Szczypce zaciskowe, uniwersalne..... 125

Welding locking pliers

Szczypce zaciskowe, spawalnicze..... 126

Flat locking pliers

Szczypce zaciskowe o szerokich szczękach..... 126

C-type welding locking pliers

Szczypce zaciskowe, klamrowe typu „C”..... 126

Chain locking pliers

Szczypce zaciskowe z łańcuchem..... 126

Self-locking multi grip pliers

Szczypce blacharskie..... 127

Chain pipe wrenches

Klucze do rur łańcuchowe

128



Tweezers

Pęsety

129



Profile connection & forming pliers

Szczypce do łączenia i kształtowania profili

127



Water pump pliers

Szczypce nastawne

128



GB Combination pliers
D Kombinationszange
PL Szczypce uniwersalne
RUS Плоскогубцы универсальные
CZ Kleště kombinované

H Kombináltfogó
RO Patent universal
E Alicates universales
CN 钢丝钳

| | | |
|----------------|------------------|--------|
| 160 mm | 180 mm | 200 mm |
| HRC 44-50 BODY | HRC 58-62 CUTTER | CrV 55 |
| DIN 5746 | | |



HALF DOUBLE BLISTER

- application: industry
- induction hardening
- przeznaczenie: przemysł
- hartowane indukcyjnie

| YATO | L (mm) |  |
|---------|--------|---|
| YT-1940 | 160 | 6/60 |
| YT-1941 | 180 | 6/60 |
| YT-1942 | 200 | 6/36 |

GB Diagonal side cutting pliers
D Seitenschneider
PL Szczypce tnące boczne
RUS Бокорезы
CZ Řezací kleště boční

H Oldal csípőfogó
RO Olește tăietor
E Alicates corte lateral
CN 斜嘴钳

| | | |
|------------------|--------|----------------|
| 160 mm | 190 mm | HRC 44-50 BODY |
| HRC 58-62 CUTTER | CrV 55 | DIN 5746 |



HALF DOUBLE BLISTER

- application: industry
- induction hardening
- przeznaczenie: przemysł
- hartowane indukcyjnie

| YATO | L (mm) |  |
|---------|--------|---|
| YT-1947 | 160 | 6/60 |
| YT-1948 | 190 | 6/60 |

GB Long nose pliers
D Radiozange
PL Szczypce wydłużone proste
RUS Тонкогубцы прямые
CZ Prodloužené kleště rovné

H Rádiófogó, egyenes
RO Clește cu vârf ascuțit
E Alicates de punta
CN 尖嘴钳

| | | |
|------------------|--------|----------------|
| 160 mm | 200 mm | HRC 44-50 BODY |
| HRC 58-62 CUTTER | CrV 55 | DIN 5746 |



HALF DOUBLE BLISTER

- application: industry
- induction hardening
- przeznaczenie: przemysł
- hartowane indukcyjnie

| YATO | L (mm) |  |
|---------|--------|---|
| YT-1943 | 160 | 6/60 |
| YT-1944 | 200 | 6/60 |

GB Bent nose pliers
D Telefonzange
PL Szczypce wydłużone wygięte
RUS Тонкогубцы изогнутые
CZ Prodloužené kleště ohnuté

H Rádió - és telefonfogó, hajlított
RO Clește cu vârf ascuțit indoit
E Alicates de punta curvos
CN 弯嘴钳

| | | |
|------------------|--------|----------------|
| 160 mm | 200 mm | HRC 44-50 BODY |
| HRC 58-62 CUTTER | CrV 55 | DIN 5746 |



HALF DOUBLE BLISTER

- application: industry
- induction hardening
- przeznaczenie: przemysł
- hartowane indukcyjnie

| YATO | L (mm) |  |
|---------|--------|---|
| YT-1945 | 160 | 6/60 |
| YT-1946 | 200 | 6/60 |

GB Combination pliers
D Kombinationszange
PL Szczypce uniwersalne
RUS Плоскогубцы универсальные
CZ Kleště kombinované

H Kombináltfogó
RO Patent universal
E Alicates universales
CN 钢丝钳

| | | |
|--------------------|--------|--------|
| 160 mm | 180 mm | 200 mm |
| DIN 5746 | | |
| NICKEL IRON FINISH | | |



HALF DOUBLE BLISTER

GB Long nose pliers
D Radiozange
PL Szczypce wydłużone proste
RUS Тонкогубцы прямые
CZ Prodloužené kleště rovné

H Rádiófogó, egyenes
RO Clește cu vârf ascuțit
E Alicates de punta
CN 尖嘴钳

| | |
|--------------------|--------|
| 160 mm | 200 mm |
| DIN 5746 | |
| NICKEL IRON FINISH | |



HALF DOUBLE BLISTER

| YATO | L (mm) |  |
|---------|--------|---|
| YT-2016 | 160 | 6/60 |
| YT-2018 | 200 | 6/60 |

GB Diagonal side cutting pliers
D Seitenschneider
PL Szczypce tnące boczne
RUS Бокорезы
CZ Řezací kleště boční

H Oldal csípőfogó
RO Olește tăietor
E Alicates corte lateral
CN 斜嘴钳

| | |
|--------------------|--------|
| 160 mm | 180 mm |
| DIN 5746 | |
| NICKEL IRON FINISH | |



HALF DOUBLE BLISTER

GB Bent nose pliers
D Telefonzange
PL Szczypce wydłużone wygięte
RUS Тонкогубцы изогнутые
CZ Prodloužené kleště ohnuté

H Rádió - és telefonfogó, hajlított
RO Clește cu vârf ascuțit indoit
E Alicates de punta curvos
CN 弯嘴钳

| | |
|--------------------|--------|
| 160 mm | 200 mm |
| DIN 5746 | |
| NICKEL IRON FINISH | |



HALF DOUBLE BLISTER

| YATO | L (mm) |  |
|---------|--------|---|
| YT-2026 | 160 | 6/60 |
| YT-2028 | 200 | 6/60 |

GB Flat nose pliers
D Elektrikerflachzange
PL Szczypce płaskie
RUS Утконосы
CZ Prodloužené kleště rovné

H Rádiófogó, egyenes
RO Clește cu vârf ascuțit
E Alicates de bocas planas
CN 平嘴钳

160 mm **DIN 5745** **NICKEL IRON FINISH**



| YATO | L (mm) | |
|---------|--------|------|
| YT-2029 | 160 | 6/60 |

GB Round nose pliers
D Rundzange
PL Szczypce okrągłe
RUS Круглогубцы
CZ Kleště kulaté

H Kerekcsőrű fogó
RO Patent rotund
E Alicates de punta redonda
CN 圆嘴钳

160 mm **DIN 5745** **NICKEL IRON FINISH**



| YATO | L (mm) | |
|---------|--------|------|
| YT-2030 | 160 | 6/60 |

GB Wire stripping pliers
D Abisolierzange
PL Szczypce do ściągania izolacji
RUS Пасатижи для зачистки проводов
CZ Kleště odizolovací na drát
H Blankoló fogó
RO Decablator
E Pinzas pelacables
CN 剥线钳

160 mm **DIN 5745** **NICKEL IRON FINISH**



| YATO | L (mm) | |
|---------|--------|------|
| YT-2031 | 160 | 6/60 |

GB End cutting pliers
D Vornschnaider
PL Szczypce tnące czolowe
RUS Кусачки торцевые
CZ Kleště štípací čelní

H Homlokcsípő fogó
RO Clește retezat
E Cortacables frontales
CN 顶切钳

160 mm **180 mm**
DIN 5748 **NICKEL IRON FINISH**



| YATO | L (mm) | |
|---------|--------|------|
| YT-2066 | 160 | 6/60 |
| YT-2067 | 180 | 6/60 |

GB Combination pliers
D Kombinationszange
PL Szczypce uniwersalne
RUS Плоскогубцы универсальные
CZ Kleště kombinované

H Kombináltfogó
RO Patent universal
E Alicates universales
CN 钢丝钳

160 mm **180 mm** **200 mm**
CrV **HRC 55-62**



| YATO | L (mm) | |
|---------|--------|------|
| YT-6600 | 160 | 6/60 |
| YT-6601 | 180 | 6/60 |
| YT-6602 | 200 | 6/36 |

GB Diagonal side cutting pliers
D Seitenschnaider
PL Szczypce tnące boczne
RUS Бокорезы
CZ Řezací kleště boční

H Oldal csípőfogó
RO Olește tăietor
E Alicates corte lateral
CN 斜嘴钳

160 mm **180 mm**
CrV **HRC 55-62**



| YATO | L (mm) | |
|---------|--------|------|
| YT-6610 | 160 | 6/60 |
| YT-6611 | 180 | 6/60 |

GB Diagonal side cutting pliers
D Seitenschnaider
PL Szczypce tnące boczne
RUS Бокорезы
CZ Řezací kleště boční
H Oldal csípőfogó
RO Olește tăietor
E Alicates corte lateral
CN 斜嘴钳



| YATO | L (mm) | |
|---------|--------|------|
| YT-6612 | 180 | 6/60 |

GB Combination pliers
D Kombinationszange
PL Szcypce uniwersalne
RUS Плоскогубцы универсальные
CZ Kleště kombinované
H Kombináltfogó
RO Patent universal
E Alicates universales
CN 钢丝钳

150
mm



200
mm

HIGH
LEVERAGE
ZWIĘKSZONA
SIŁA NACISKU



HALF
DOUBLE
BLISTER



| YATO  | L (mm) |  |
|--|--------|---|
| YT-6581 | 150 | 6/60 |
| YT-6582 | 200 | 6/36 |

6

GB Diagonal side cutting pliers
D Seitenschneider
PL Szcypce tnące boczne
RUS Бокорезы
CZ Řezací kleště boční
H Oldal csípőfogó
RO Olește tăietor
E Alicates corte lateral
CN 斜嘴钳



150
mm

HIGH
LEVERAGE
ZWIĘKSZONA
SIŁA NACISKU



HALF
DOUBLE
BLISTER



| YATO  | L (mm) |  |
|--|--------|---|
| YT-6583 | 150 | 6/60 |

GB Long nose pliers
D Radiozange
PL Szcypce wydłużone proste
RUS Тонкогубцы прямые
CZ Prodloužené kleště rovné
H Rádiófogó, egyenes
RO Clește cu vârf ascuțit
E Alicates de punta
CN 尖嘴钳

150
mm



200
mm

HIGH
LEVERAGE
ZWIĘKSZONA
SIŁA NACISKU



HALF
DOUBLE
BLISTER



| YATO  | L (mm) |  |
|--|--------|---|
| YT-6586 | 150 | 6/60 |
| YT-6587 | 200 | 6/36 |

GB Combination pliers
D Kombinationszange
PL Szczypce uniwersalne
RUS Плоскогубцы универсальные
CZ Kleště kombinované
H Kombináltfogó

RO Patent universal
E Alicates universales
CN 钢丝钳

115 mm

NICKEL IRON FINISH



YATO L (mm) 6/120
YT-2080 115

GB Diagonal side cutting pliers
D Seitenschneider
PL Szczypce tnące boczne
RUS Бокорезы
CZ Řezací kleště boční
H Oldal csípőfogó

RO Olește tăietor
E Alicates corte lateral
CN 斜口钳

115 mm

NICKEL IRON FINISH



YATO L (mm) 6/120
YT-2081 115

6

GB Long nose mini pliers
D Radiozange
PL Szczypce wydłużone proste
RUS Тонкогубцы
CZ Prodloužené kleště rovné

H Rádiófogó, egyenes
RO Clește cu vârf ascuțit
E Alicates de punta
CN 尖嘴钳

115 mm

NICKEL IRON FINISH



YATO L (mm) 6/120
YT-2083 115

GB Bent nose mini pliers
D Telefonzange
PL Szczypce wydłużone wygięte
RUS Тонкогубцы изогнутые
CZ Prodloužené kleště ohnuté

H Rádió - és telefonfogó hajlítót
RO Clește cu vârf ascuțit îndoit
E Alicates de punta curvos
CN 弯嘴钳

115 mm

NICKEL IRON FINISH



YATO L (mm) 6/120
YT-2084 115

GB Flat nose mini pliers
D Flachzange
PL Szczypce płaskie
RUS Утконосы
CZ Prodloužené kleště rovné

H Rádiófogó, egyenes
RO Clește cu vârf ascuțit
E Alicates de bocas planas
CN 平口钳

115 mm

NICKEL IRON FINISH



YATO L (mm) 6/120
YT-2085 115

GB Round nose pliers
D Rundzange
PL Szczypce okrągłe
RUS Круглогубцы
CZ Kleště kulaté

H Gömbölyfogó
RO Patent rotund
E Alicates de punta redonda
CN 圆嘴钳

115 mm

NICKEL IRON FINISH



YATO L (mm) 6/120
YT-2086 115

GB End cutting pliers
D Vornschnieder
PL Szczypce tnące czolowe
RUS Кусачки торцевые
CZ Kleště štípací čelní
H Homlokcsípő fogó
RO Clește retezat
E Cortacables frontales
CN 迷你顶切钳



115 mm

NICKEL IRON FINISH

YATO L (mm) 6/120
YT-2082 115



GB Combination pliers
D Kombinationszange
PL Szczypce uniwersalne
RUS Плоскогубцы универсальные
CZ Kleště kombinované

H Kombináltfogó
RO Patent universal
E Alicates universales
CN 钢丝钳

160 mm 180 mm 200 mm
CrV HRC 56-62



SLIDING CARD 

| YATO  | L (mm) |  |
|--|--------|---|
| YT-6620 | 160 | 6/60 |
| YT-6621 | 180 | 6/60 |
| YT-6622 | 200 | 6/36 |



GB Diagonal side cutting pliers
D Seitenschneider
PL Szczypce tnące boczne
RUS Бокорезы
CZ Řezací kleště boční

H Oldal csipőfogó
RO Olește tăietor
E Alicates corte lateral
CN 斜口钳

140 mm 160 mm 180 mm
CrV HRC 56-62



SLIDING CARD 

| YATO  | L (mm) |  |
|--|--------|---|
| YT-6628 | 140 | 6/60 |
| YT-6629 | 160 | 6/60 |
| YT-6630 | 180 | 6/60 |



GB Long nose mini pliers
D Radiozange
PL Szczypce wydłużone proste
RUS Тонкогубцы
CZ Prodloužené kleště rovné

H Rádiófogó, egyenes
RO Clește cu vârf ascuțit
E Alicates de punta
CN 尖嘴钳

160 mm 200 mm
CrV HRC 56-62



SLIDING CARD 

| YATO  | L (mm) |  |
|--|--------|---|
| YT-6623 | 160 | 6/60 |
| YT-6624 | 200 | 6/36 |



GB Long nose mini pliers
D Radiozange
PL Szczypce wydłużone proste
RUS Тонкогубцы
CZ Prodloužené kleště rovné

H Rádiófogó, egyenes
RO Clește cu vârf ascuțit
E Alicates de punta
CN 尖嘴钳

160 mm CrV HRC 56-62



SLIDING CARD 

| YATO  | L (mm) |  |
|--|--------|---|
| YT-6625 | 160 | 6/60 |



GB Long nose mini pliers
D Radiozange
PL Szczypce wydłużone proste
RUS Тонкогубцы
CZ Prodloužené kleště rovné

H Rádiófogó, egyenes
RO Clește cu vârf ascuțit
E Alicates de punta
CN 尖嘴钳

160 mm CrV HRC 56-62



SLIDING CARD 



| YATO  | L (mm) |  |
|--|--------|---|
| YT-6626 | 160 | 6/60 |

GB End cutting pliers
D Vornschnieder
PL Szczypce tnące czołowe
RUS Кусачки торцевые
CZ Kleště štípací čelní
H Homlokcsipő fogó
RO Clește retezat
E Cortacables frontales
CN 顶切钳

160 mm CrV HRC 56-62



SLIDING CARD 

| YATO  | L (mm) |  |
|--|--------|---|
| YT-6631 | 160 | 6/60 |

GB Combination pliers
 D Kombinationszange
 PL Szczypce uniwersalne
 RUS Плоскогубцы универсальные
 CZ Kleště kombinované
 H Kombináltfogó
 RO Patent universal
 E Alicates universales
 CN 钢丝钳

160 mm 180 mm 200 mm 1000 V DIN 5746 CrV



05 VDE CERTIFICATE -IEC60900:2004 HALF DOUBLE BLISTER

| YATO | L (mm) | |
|---------|--------|------|
| YT-2101 | 160 | 6/60 |
| YT-2102 | 180 | 6/60 |
| YT-2103 | 200 | 6/60 |

GB Diagonal side cutting pliers
 D Seitenschneider
 PL Szczypce tnące boczne
 RUS Бокорезы
 CZ Řezací kleště boční
 H Oldal csípőfogó
 RO Olește tăietor
 E Alicates corte lateral
 CN 斜口钳

160 mm 1000 V DIN 5749 CrV



05 VDE CERTIFICATE -EN60900:2004 HALF DOUBLE BLISTER

| YATO | L (mm) | |
|---------|--------|------|
| YT-2109 | 160 | 6/60 |

GB Diagonal side cutting pliers
 D Seitenschneider
 PL Szczypce tnące boczne
 RUS Бокорезы
 CZ Řezací kleště boční
 H Oldal csípőfogó
 RO Olește tăietor
 E Alicates corte lateral
 CN 斜口钳

180 mm 1000 V DIN 5749 CrV



05 VDE CERTIFICATE -EN60900:2004 HALF DOUBLE BLISTER

| YATO | L (mm) | |
|---------|--------|------|
| YT-2110 | 180 | 6/60 |

GB Long nose pliers
 D Radiozange
 PL Szczypce wydłużone proste
 RUS Тонкогубцы
 CZ Prodloužené kleště rovné
 H Rádiófogó, egyenes
 RO Clește cu vârf ascuțit
 E Alicates de punta
 CN 尖嘴钳

160 mm 200 mm 1000 V DIN 5745 CrV



05 VDE CERTIFICATE -EN60900:2004 HALF DOUBLE BLISTER

| YATO | L (mm) | |
|---------|--------|------|
| YT-2104 | 160 | 6/60 |
| YT-2105 | 200 | 6/60 |

GB Bent nose pliers
 D Telefonzange
 PL Szczypce wydłużone wygięte
 RUS Тонкогубцы изогнутые
 CZ Prodloužené kleště ohnuté
 H Rádió - és telefonfogó hajlítót
 RO Clește cu vârf ascuțit îndoit
 E Alicates de punta curvos
 CN 弯嘴钳

200 mm 1000 V DIN 5745 CrV



05 VDE CERTIFICATE -EN60900:2004 HALF DOUBLE BLISTER

| YATO | L (mm) | |
|---------|--------|------|
| YT-2107 | 200 | 6/60 |

GB Wire stripping pliers
 D Abisolierzange
 PL Szczypce do ściągania izolacji
 RUS Пасатижи для зачистки проводов
 CZ Kleště odizolovací na drát
 H Blankoló fogó
 RO Decablator
 E Pinzas pelacables
 CN 剥线钳

160 mm 1000 V DIN 5745 CrV



05 VDE CERTIFICATE -EN60900:2004 HALF DOUBLE BLISTER

| YATO | L (mm) | |
|---------|--------|------|
| YT-2112 | 160 | 6/60 |

GB Side cutting pliers
D Seitenschneider
PL Szczypce tnące boczne
RUS Бокорезы
CZ Řezací kleště boční
H Oldal csípőfogó

RO Olește tăietor
E Alicates corte lateral
CN 水口钳

125 mm CrV 60
HRC CUTTER 56-62 HRC BODY 43-48
FOR PLASTIC max. ∅ 3 mm



SLIDING CARD

| | | |
|-------------|--------|-------|
| YATO | L (mm) | |
| YT-1950 | 125 | 6/120 |

GB Side cutting pliers
D Seitenschneider
PL Szczypce tnące boczne
RUS Бокорезы
CZ Řezací kleště boční
H Oldal csípőfogó

RO Olește tăietor
E Alicates corte lateral
CN 水口钳

150 mm CrV 60
HRC CUTTER 56-62 HRC BODY 43-48
FOR PLASTIC max. ∅ 5 mm



SLIDING CARD

| | | |
|-------------|--------|-------|
| YATO | L (mm) | |
| YT-1951 | 150 | 6/120 |

GB Side cutting pliers
D Seitenschneider
PL Szczypce tnące boczne
RUS Бокорезы
CZ Řezací kleště boční
H Oldal csípőfogó

RO Olește tăietor
E Alicates corte lateral
CN 水口钳

180 mm CrV 60
HRC CUTTER 56-62 HRC BODY 43-48
FOR PLASTIC max. ∅ 6 mm



SLIDING CARD

| | | |
|-------------|--------|------|
| YATO | L (mm) | |
| YT-1952 | 180 | 6/60 |

GB Side cutting pliers
D Seitenschneider
PL Szczypce tnące boczne
RUS Бокорезы
CZ Řezací kleště boční
H Oldal csípőfogó

RO Olește tăietor
E Alicates corte lateral
CN 斜嘴钳

100 mm CrV 60
HRC CUTTER 56-62 HRC BODY 43-48
FOR CABLE CUTTING max. ∅ 1.0 mm
COPPER max. ∅ 1.8 mm



SLIDING CARD

| | | |
|-------------|--------|-------|
| YATO | L (mm) | |
| YT-1953 | 100 | 6/120 |

GB Side cutting pliers
D Seitenschneider
PL Szczypce tnące boczne
RUS Бокорезы
CZ Řezací kleště boční
H Oldal csípőfogó

RO Olește tăietor
E Alicates corte lateral
CN 斜嘴钳

125 mm CrV 60
HRC CUTTER 56-62 HRC BODY 43-48
FOR CABLE CUTTING max. ∅ 1.2 mm
COPPER max. ∅ 2.0 mm



SLIDING CARD

| | | |
|-------------|--------|-------|
| YATO | L (mm) | |
| YT-1954 | 125 | 6/120 |

GB Long nose pliers
D Radiozange
PL Szczypce wydłużone proste
RUS Тонкогубцы прямые
CZ Prodloužené kleště rovné
H Rádiófogó, egyenes
RO Clește cu vârf ascuțit
E Alicates de punta
CN 斜嘴钳

150 mm CrV 60
HRC CUTTER 56-62 HRC BODY 43-48
STEEL max. ∅ 1.5 mm COPPER max. ∅ 2.6 mm



SLIDING CARD

| | | |
|-------------|--------|-------|
| YATO | L (mm) | |
| YT-1956 | 150 | 6/120 |

GB Carpenter's pliers
D Kneifzange
PL Obcegi
RUS Клещи строительные

CZ Kleště
H Harapófógó
RO Cleste cuie

E Tenazas
CN 胡桃钳

160 mm 180 mm 200 mm DIN 5748 NICKEL IRON FINISH



HALF DOUBLE BLISTER



| YATO | L (mm) | |
|---------|--------|------|
| YT-2046 | 160 | 6/60 |
| YT-2047 | 180 | 6/60 |
| YT-2048 | 200 | 6/60 |

GB Tower pincers
D Beisszange
PL Obcegi tynkarskie
RUS Клещи штукатурные

CZ Kleště štípací čelní
H Rabitzfógó
RO Cleste pt. cuie

E Tenazas de enlucido
CN 扎线钳

200 mm 250 mm 275 mm DIN 5748 NICKEL IRON FINISH



HALF DOUBLE BLISTER



| YATO | L (mm) | |
|---------|--------|------|
| YT-2058 | 200 | 6/60 |
| YT-2060 | 250 | 6/36 |
| YT-2061 | 275 | 6/36 |

GB Tower pincers
D Beisszange
PL Obcegi tynkarskie
RUS Клещи штукатурные

CZ Kleště štípací čelní
H Rabitzfógó
RO Cleste pt. cuie

E Tenazas de enlucido
CN 扎线钳

250 mm HRC 44-50 BODY HRC 58-62 CUTTER CrV 55 DIN 5746



HALF DOUBLE BLISTER



| YATO | L (mm) | |
|---------|--------|------|
| YT-1949 | 250 | 6/36 |

GB Heavy duty side cutting pliers
D Seitenschneider, Schwer Typ
PL Szczypce tnące boczne
RUS Бокорезы усиленные
CZ Řezací kleště boční

H Oldal csípófógó
RO Olește tăietor
E Alicates de corte lateral tipo pesado
CN 重型斜口钳

180 mm DIN 5749 NICKEL IRON FINISH



HALF DOUBLE BLISTER



| YATO | L (mm) | |
|---------|--------|------|
| YT-2039 | 180 | 6/60 |

GB Carpenter's pliers
D Kneifzange
PL Obcegi

RUS Клещи строительные
CZ Kleště
H Harapófógó

RO Cleste cuie
E Tenazas
CN 胡桃钳

150 mm 175 mm 200 mm CrV 50 HRC 55-60 HEAD GLOWECA



SLIDING CARD



| YATO | L (mm) | cold rolled steel (mm) stal walcowana na zimno (mm) | PCS. packing | |
|---------|--------|--|-----------------|----|
| YT-2050 | 150 | 1.5 | 6 | 60 |
| YT-2051 | 175 | 1.8 | 6 | 60 |
| YT-2052 | 200 | 2.0 | 6 | 48 |

GB Tower pincers
D Beisszange
PL Obcegi tynkarskie

RUS Клещи штукатурные
CZ Kleště štípací čelní
H Rabitzfógó

RO Cleste pt. cuie
E Tenazas de enlucido
CN 扎线钳

225 mm 250 mm 275 mm CrV 50 HRC 55-62 HEAD GLOWECA



SLIDING CARD



| YATO | L (mm) | cold rolled steel (mm) stal walcowana na zimno (mm) | |
|---------|--------|--|------|
| YT-2055 | 225 | 1.8 | 6/60 |
| YT-2056 | 250 | 2.0 | 6/48 |
| YT-2057 | 275 | 2.2 | 6/24 |

GB End cutting pliers
D Vornschneider
PL Szczypce tnące czolowe

RUS Кусачки торцевые
CZ Kleště štípací čelní
H Homlokcsípó fogó

RO Cleste retezat
E Cortacables frontales
CN 顶切钳

150 mm 175 mm 200 mm CrV 50 HRC 55-60 HEAD GLOWECA



SLIDING CARD



| YATO | L (mm) | cold rolled steel (mm) stal walcowana na zimno (mm) | |
|---------|--------|--|------|
| YT-2062 | 150 | 1.2 | 6/60 |
| YT-2063 | 175 | 1.5 | 6/48 |
| YT-2064 | 200 | 1.8 | 6/48 |

GB Circlip pliers
D Seegeringgzange
PL Szczypce Segera
RUS Съёмник стопорных колец
CZ Kleště Segera









H Segerfogó belső
RO Clește Seger
E Alicates Seger
CN 5件套卡簧钳

5
PCS



160
mm

∅ mm
10-50



| | | | | |
|---|---|------------|---|------------|
|  |  | 23 mm max. |  | 20 mm max. |
|  |  | 28 mm max. |  | 23 mm max. |
|  |  | 30 mm max. |  | 27 mm max. |



| YATO  | L (mm) |  |
|--|--------|---|
| YT-2130 | 160 | 20/60 |

6

GB Circlip pliers
D Seegeringgzange
PL Szczypce Segera
RUS Съёмник стопорных колец
CZ Kleště Segera

H Segerfogó belső
RO Clește Seger
E Alicates Seger
CN 直嘴轴用挡圈钳

SLIDING
CARD







180
mm

HRC
42-48



CrV
50





| YATO  | L (mm) |  |
|--|--------|---|
| YT-2136 | 180 | 6/24 |

| YATO  | L (mm) |  |
|--|--------|---|
| YT-2138 | 180 | 6/24 |



| YATO  | L (mm) |  |
|--|--------|---|
| YT-2137 | 180 | 6/24 |

| YATO  | L (mm) |  |
|--|--------|---|
| YT-2139 | 180 | 6/24 |

GB Circlip pliers
 D Seegeringgzange
 PL Szczypce Segera
 RUS Съёмник
 стопорных колец
 CZ Kleště Segera
 H Segerfogó belső
 RO Clește Seger
 E Alicates Seger
 CN 直嘴轴用挡圈钳

SLIDING
CARD



150 mm
 200 mm
 CrV
 NICKEL
IRON
FINISH



| YATO | L (mm) | |
|---------|--------|-------|
| YT-2140 | 150 | 6/120 |
| YT-2144 | 200 | 6/60 |



| YATO | L (mm) | |
|---------|--------|-------|
| YT-2141 | 150 | 6/120 |
| YT-2145 | 200 | 6/60 |



| YATO | L (mm) | |
|---------|--------|------|
| YT-2142 | 150 | 6/60 |
| YT-2146 | 200 | 6/60 |



| YATO | L (mm) | |
|---------|--------|-------|
| YT-2143 | 150 | 6/120 |
| YT-2147 | 200 | 6/60 |

GB Circlip pliers
 D Seegeringgzange
 PL Szczypce Segera
 RUS Съёмник
 стопорных колец
 CZ Kleště Segera
 H Segerfogó belső
 RO Clește Seger
 E Alicates Seger
 CN 直嘴轴用挡圈钳

SLIDING
CARD



225 mm
 325 mm
 NICKEL
FINISH
 CrV



| YATO | L (mm) | |
|---------|--------|------|
| YT-1988 | 225 | 6/60 |
| YT-1992 | 325 | 6/48 |



| YATO | L (mm) | |
|---------|--------|------|
| YT-1989 | 225 | 6/60 |
| YT-1993 | 325 | 6/48 |



| YATO | L (mm) | |
|---------|--------|------|
| YT-1990 | 225 | 6/60 |
| YT-1994 | 325 | 6/48 |



| YATO | L (mm) | |
|---------|--------|------|
| YT-1991 | 225 | 6/60 |
| YT-1995 | 325 | 6/48 |

GB Lock grip pliers
D Gripzange
PL Szczypce Morse'a
RUS Зажим ручной
CZ Kleště Morse'a

H Morse fogó
RO Clește Morse
E Alicates Morse
CN 圆口大力钳

HALF
DOUBLE
BLISTER



140
mm

240
mm

180
mm



WR
TYPE





165
mm

220
mm

CD
TYPE

| YATO  | L (mm) |  |
|--|--------|---|
| YT-2151 | 140 | 6/48 |
| YT-2152 | 180 | 6/36 |
| YT-2153 | 240 | 6/36 |

| YATO  | L (mm) |  |
|--|--------|---|
| YT-2155 | 165 | 6/48 |
| YT-2156 | 220 | 6/36 |

GB Locking pliers
D Klemmzange
PL Szczypce zaciskowe
RUS Клещи давяльные
CZ Kleště samosvorné

H Patentfogó
RO Clește de strângere
E Pinzas de tornillo (de apriete)
CN 圆口大力钳



HALF
DOUBLE
BLISTER





125
mm



250
mm

| YATO  | L (mm) |  |
|---|--------|--|
| YT-2449 | 125 | 6/24 |



| YATO  | L (mm) |  |
|---|--------|--|
| YT-2453 | 250 | 6/24 |





180
mm



150
mm

| YATO  | L (mm) |  |
|--|--------|---|
| YT-2450 | 180 | 6/24 |



| YATO  | L (mm) |  |
|--|--------|---|
| YT-2459 | 150 | 6/24 |





250
mm





225
mm

| YATO  | L (mm) |  |
|--|--------|---|
| YT-2451 | 250 | 6/24 |

| YATO  | L (mm) |  |
|--|--------|---|
| YT-2460 | 225 | 6/24 |



180
mm

| YATO  | L (mm) |  |
|--|--------|---|
| YT-2452 | 180 | 6/24 |

GB Locking pliers
D Klemmzange
PL Szczypce zaciskowe
RUS Клещи давящие
CZ Kleště samosvorné

H Patentfogó
RO Clește de strângere
E Pinzas
de tornillo (de apriete)
CN 大力钳



CrMo



250 mm

0-42 mm

| YATO | L (mm) | |
|---------|--------|------|
| YT-2473 | 250 | 6/24 |



250 mm

0-42 mm

| YATO | L (mm) | |
|---------|--------|------|
| YT-2476 | 250 | 6/24 |

GB C-type welding locking pliers
D Klemm- und Klammerzange vom Typ „C“
PL Szczypce zaciskowe klamrowe typu „C“
RUS Клещи давящие типа „C“
CZ Kleště samosvorné upínací typu „C“

H „C“ fogó
RO Clește de strângere cu clemă tip „C“
E Pinzas de tornillo (de apriete) de grapa tipo „C“
CN C型大力钳

HALF DOUBLE BLISTER



280 mm

0-100 mm

TYPE C



| YATO | L (mm) | |
|---------|--------|------|
| YT-2466 | 280 | 6/24 |

| YATO | L (mm) | |
|---------|--------|------|
| YT-2468 | 280 | 6/24 |

GB Chain locking pliers
D Klemmzange mit Kette
PL Szczypce zaciskowe z łańcuchem
RUS Клещи давящие с цепью
CZ Kleště samosvorné s řetězem
H Láncos csőfogó
RO Clește de strângere cu lanț
E Pinzas de tornillo (de apriete) con cadena
CN 链条大力钳



HALF DOUBLE BLISTER



500 mm

40 Mn

| YATO | | |
|---------|--|------|
| YT-2469 | | 6/24 |

GB Welding locking pliers
D Klemmzange zum Schweißen
PL Szczypce zaciskowe spawalnicze
RUS Клещи давящие сварочные
CZ Kleště samosvorné svářečské
H Hegesztő fogó
RO Clește de strângere pt. sudură
E Pinzas de tornillo (de apriete) para soldar
CN 焊接用大力钳

HALF DOUBLE BLISTER



225 mm

TYPE U



| YATO | L (mm) | |
|---------|--------|------|
| YT-2461 | 225 | 6/24 |

GB Flat locking pliers
D Klemmzange mit breiten Backen
PL Szczypce zaciskowe o szerokich szczękach
RUS Клещи давящие с широкими губками
CZ Kleště samosvorné se širokými čelistmi
H Lapos fogó
RO Clește de strângere plat / patent
E Pinzas de tornillo (de apriete) con mordazas anchas
CN 铁皮大力钳

HALF DOUBLE BLISTER



200 mm

0-12.7 mm

78 mm



| YATO | L (mm) | |
|---------|--------|------|
| YT-2463 | 200 | 6/24 |

- GB Self-locking multi grip pliers
D Grip-Festhaltezange
PL Szczypce blacharskie
RUS Зажим ручной сварочный для закрепления лент и профилей
CZ Kleště klempířské samodržící
H Őnzáró rögztífogó
RO Cleste autoblocant pt. tinichigerie
E Pinzas de chapa
CN 多功能大力钳

SLIDING CARD



CrMo



200 mm 0-15 mm 70 mm TYPE W

| YATO | L (mm) | |
|---------|--------|-------|
| YT-2160 | 200 | 12/24 |



230 mm 0-15 mm 45 mm TYPE JJ

| YATO | L (mm) | |
|---------|--------|-------|
| YT-2161 | 230 | 12/24 |



215 mm 0-10 mm 45 mm TYPE LL

| YATO | L (mm) | |
|---------|--------|-------|
| YT-2162 | 215 | 12/36 |



210 mm 0-15 mm 25 mm TYPE J

| YATO | L (mm) | |
|---------|--------|-------|
| YT-2163 | 210 | 12/36 |



195 mm 0-18 mm 25 mm TYPE L

| YATO | L (mm) | |
|---------|--------|-------|
| YT-2164 | 195 | 12/36 |

- GB Profile connection pliers
D Zange zum Verbinden der Profile
PL Szczypce do łączenia profili
RUS Щипцы для соединения профилей
CZ Kleště ke spojování profilů
H Profilgyesítő fogó
RO Cleste pt. imbinarea profilelor
E Pinzas para conectar perfiles
CN 龙骨钳

SLIDING CARD



SECTION THICKNESS GRUBOSC PROFILU 0,5-0,8 mm

275 mm A380 Al-Ti ALLOY (HEAD) GR15 BEARING STEEL (PUNCH)

| YATO | L (mm) | |
|---------|--------|------|
| YT-5130 | 275 | 6/24 |



345 mm 65 Mn MATERIAL OF PUNCH PUNKTAK

| YATO | L (mm) | |
|---------|--------|------|
| YT-5131 | 345 | 6/24 |

- GB Profile forming pliers
D Zange zur Formgebung der Profile
PL Szczypce do kształtowania profili
RUS Щипцы для формировки профилей
CZ Kleště k tvarování profilů
H Profilformázó fogó
RO Cleste pt. modelarea profilelor
E Pinzas para formar perfiles
CN 龙骨钳

SLIDING CARD



210 mm

80x35 mm JAWS SZCZKI

| YATO | L (mm) | |
|---------|--------|------|
| YT-5140 | 210 | 2/12 |



80x35 mm JAWS SZCZKI

| YATO | L (mm) | |
|---------|--------|------|
| YT-5141 | 210 | 2/12 |



150x35 mm JAWS SZCZKI

| YATO | L (mm) | |
|---------|--------|------|
| YT-5142 | 210 | 2/12 |



GB Adjustable pliers
D Verstellbare Kombizange
PL Szczypce przestawne
RUS Переставные клещи
CZ Kleště přestavitelné

H Állítható fogó
RO Cleste pivot
E Pinzas ajustables
CN 鲤鱼钳



HALF DOUBLE BLISTER
150 mm
HRC 45-55



| YATO | L (mm) | max. working range (mm) max. rozstaw (mm) | |
|---------|--------|--|------|
| YT-1957 | 150 | 65-70 | 6/60 |

GB Water pump pliers
D Wasserpumpenzange
PL Szczypce nastawne
RUS Клещи переставные
CZ Keleště siko

H Vízpumpafagó
RO Cleste papagal
E Alicates de fontanero ajustables
CN 水泵钳

250 mm **300 mm** **CrV**



| YATO | L (mm) | |
|---------|--------|------|
| YT-2090 | 250 | 6/36 |
| YT-2091 | 300 | 6/36 |

GB Water pump pliers
D Wasserpumpenzange
PL Szczypce nastawne
RUS Клещи переставные
CZ Keleště siko

H Vízpumpafagó
RO Cleste papagal
E Alicates de fontanero ajustables
CN 水泵钳



HALF DOUBLE BLISTER
250 mm
NICKEL IRON FINISH



| YATO | L (mm) | |
|---------|--------|------|
| YT-2069 | 250 | 6/36 |



| YATO | L (mm) | |
|---------|--------|------|
| YT-2070 | 250 | 6/24 |

GB Pipe wrench
D Rohrschlüssel
PL Klucz do rur

RUS Ключ трубный
CZ Klíč součásti na trubky

H Csőkulcs
RO Cheie reglabila pt. tevi

E Llave para tubos
CN 铝合金管钳

CrMo



| YATO | size / rozmiar | max. pipe diameter / max. średnica rury | |
|---------|----------------|--|------|
| YT-2482 | 14" (350 mm) | 2" (50 mm) | 6/12 |
| YT-2483 | 18" (450 mm) | 2.5" (63 mm) | 2/10 |
| YT-2484 | 24" (600 mm) | 3" (75 mm) | 2/6 |
| YT-2485 | 36" (900 mm) | 5" (125 mm) | 3 |

| YATO | size / rozmiar | max. pipe diameter / max. średnica rury | |
|---------|----------------|--|------|
| YT-2488 | 10" (250 mm) | 1" (25 mm) | 6/18 |
| YT-2489 | 12" (300 mm) | 1.5" (38 mm) | 6/12 |
| YT-2490 | 14" (350 mm) | 2" (50 mm) | 2/10 |
| YT-2491 | 18" (450 mm) | 2.5" (63 mm) | 3/6 |
| YT-2492 | 24" (600 mm) | 3" (75 mm) | 2/4 |
| YT-2493 | 36" (900 mm) | 5" (125 mm) | 1 |
| YT-2494 | 48" (1200 mm) | 6" (150 mm) | 1 |
| YT-2495 | 60" (1500 mm) | 8" (200 mm) | 1 |

GB Pipe wrench
D Rohrschlüssel
PL Klucz do rur

RUS Ключ трубный
CZ Klíč součásti na trubky

H Csőkulcs
RO Cheie reglabila pt. tevi

E Llave para tubos
CN 铝合金管钳

OFFSET TYPE



| YATO | size / rozmiar | max. pipe diameter / max. średnica rury | |
|---------|----------------|--|------|
| YT-2201 | 10" (250 mm) | 1" (25 mm) | 6/36 |
| YT-2203 | 14" (350 mm) | 1.5" (38 mm) | 4/16 |
| YT-2204 | 18" (450 mm) | 2" (50 mm) | 3/12 |
| YT-2205 | 24" (600 mm) | 2.5" (63 mm) | 3/6 |
| YT-2206 | 36" (900 mm) | 4" (100 mm) | 2/4 |

GB Pipe wrench
D Rohrschlüssel
PL Klucz do rur
RUS Ключ трубный

CZ Klíč součásti na trubky
H Csőkulcs
RO Cheie reglabila pt. tevi

E Llave para tubos
CN 铝合金管钳

GB Chain pipe wrench
D Kettenrohrzange
PL Klucz łańcuchowy do rur
RUS Ключ цепной для труб
CZ Klíč řetězový na trubky
H Láncos csőfogó

RO Cheie reglabila pt. tevi cu lant
E Llave de cadena
CN 链条管子钳

SLIDING CARD

300 mm
4"
Ø100 mm
INDUCTIVELY HARDENED TEETH
ZĘBY HARTOWANE INDUKCYJNIE
ADJUSTABLE WORKING RANGE
REGULOWANY ZAKRES PRACY



AI HANDLE

| YATO | size / rozmiar | max. pipe diameter / max. średnica rury | |
|---------|----------------|--|------|
| YT-2222 | 12" (300 mm) | 1" (25 mm) | 6/24 |
| YT-2223 | 14" (350 mm) | 1.5" (38 mm) | 4/16 |
| YT-2224 | 18" (450 mm) | 2" (50 mm) | 3/12 |
| YT-2225 | 24" (600 mm) | 2.5" (63 mm) | 3/6 |

| YATO | L (mm) | max. pipe diameter / max. średnica rury | |
|----------|--------|--|------|
| YT-22260 | 300 | 4" (100 mm) | 6/24 |

GB Tweezer *RUS* Пинцет *RO* Pensetă
 D Pinzette *CZ* Pinzeta *E* Pinzas
 PL Pęseta *H* Csipesz *CN* 镊子

SLIDING
CARD



302
STAINLESS
STEEL
STAL
NIEODŻEWNA

ANTI
MAGNETIC
ANTYMAG-
NETYCZNA

ANTIACID
KWASO-
ODPORNA



140
mm **HRC**
30

| | | |
|-------------|--------|--------|
| YATO | L (mm) | |
| YT-6903 | 140 | 20/480 |



115
mm **HRC**
30

| | | |
|-------------|--------|--------|
| YATO | L (mm) | |
| YT-6907 | 115 | 20/480 |



140
mm **HRC**
40

| | | |
|-------------|--------|--------|
| YATO | L (mm) | |
| YT-6916 | 140 | 20/480 |

Memo

7

Electrician tools Narzędzia dla elektryków



Crimping pliers & sets

Szczypce do zaciskania konektorów i zestawy

132-134



Cable cutters

Nożyce do kabli

138



Hydraulic pliers

Ręczne praski hydrauliczne

134



Electric meters & voltage testers

Mierniki elektryczne i próbniki napięcia

139



Wire strippers

Ściągacze izolacji

135-137



Multimeters

Mierniki

140



Electrical cutters

Obcinaki elektryczne

138



Electrical insulation tapes & sets

Taśmy elektroizolacyjne i zestawy

141



- GB Quick interchangeable ratchet crimper set
- D Kabelschuhzange
- PL Zestaw do zaciskania konektorów
- RUS Инструмент для обжима и зачистки проводов
- CZ Kleště pro svěráni zaciskania konektorů
- H Krimpelő fogó
- RO Clește sertizat conectori
- E Pinzas de apretar de conectores
- CN 棘轮压线钳组套



BMC & COLOR SLEEVE



| | | | |
|----------|-----------|--|--|
| 6 PCS | 260 mm | 20-10 (AWG) 0.5-6.0 mm² (DIN) | 22-10 (AWG) 0.5-6.0 mm² (DIN) |
| RG 6 | RG 58 | 20-8 (AWG) 1.5-10.0 mm² (DIN) | 22-12 (AWG) 0.5-4.0 mm² (DIN) |
| RG 59 | RG 62 | | |

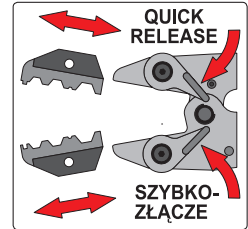

| | | |
|-------------|--------|----|
| YATO | L (mm) | |
| YT-2245 | 260 | 10 |

7

- GB Ratchet crimping pliers
- CZ Kleště pro svěráni zaciskania konektorů
- D Kabelschuhzange
- H Krimpelő fogó
- PL Szczypce do zaciskania konektorów
- RO Clește sertizat conectori
- RUS Инструмент для обжима и зачистки проводов
- E Pinzas de apretar de conectores
- CN 棘轮压线钳

SLIDING CARD



| | | | | |
|-----------|--|-------------|--------|------|
| 230 mm | 22-10 (AWG) 0.5-6.0 mm² (DIN) | YATO | L (mm) | |
| | | YT-2296 | 230 | 5/30 |



| | | | | |
|-----------|--|-------------|--------|------|
| 220 mm | 22-10 (AWG) 0.5-6.0 mm² (DIN) | YATO | L (mm) | |
| | | YT-2246 | 220 | 5/30 |



| | | | | |
|-----------|--|-------------|--------|------|
| 230 mm | 20-8 (AWG) 1.5-10.0 mm² (DIN) | YATO | L (mm) | |
| | | YT-2297 | 230 | 5/30 |



| | | | | |
|-----------|--|-------------|--------|------|
| 220 mm | 20-8 (AWG) 1.5-10.0 mm² (DIN) | YATO | L (mm) | |
| | | YT-2247 | 220 | 5/30 |



| | | | | | |
|-----------|-------|-------|-------------|--------|------|
| 240 mm | RG 6 | RG 58 | YATO | L (mm) | |
| | RG 59 | RG 62 | YT-2298 | 240 | 5/30 |



| | | | | | |
|-----------|-------|-------|-------------|--------|------|
| 220 mm | RG 6 | RG 58 | YATO | L (mm) | |
| | RG 59 | RG 62 | YT-2248 | 220 | 5/30 |



| | | | | |
|-----------|--|-------------|--------|------|
| 230 mm | 22-12 (AWG) 0.5-4.0 mm² (DIN) | YATO | L (mm) | |
| | | YT-2299 | 230 | 5/30 |



| | | | | |
|-----------|--|-------------|--------|------|
| 220 mm | 22-12 (AWG) 0.5-4.0 mm² (DIN) | YATO | L (mm) | |
| | | YT-2249 | 220 | 5/30 |

GB Ratchet crimping pliers
D Kabelschuhzange
PL Szczypce do zaciskania konektorów

RUS Инструмент для обжима и зачистки проводов
CZ Kleště pro svěráni zaciskania konektorů
H Krimpelő fogó

RO Clește sertizat conectori
E Pinzas de apretar de conectores
CN 棘轮压线钳

SLIDING
CARD





220
mm



20-18
(AWG)
0.5-1.0
mm² (DIN)



16-14
(AWG)
1.5-2.5
mm² (DIN)

12-10
(AWG)
4.0-6.0
mm² (DIN)



| | | |
|---|--------|---|
| YATO  | L (mm) |  |
| YT-2250 | 220 | 5/30 |

230
mm

20-18
(AWG)
0.5-1.0
mm² (DIN)

16-14
(AWG)
1.5-2.5
mm² (DIN)

12-10
(AWG)
4.0-6.0
mm² (DIN)

| | | |
|---|--------|---|
| YATO  | L (mm) |  |
| YT-2300 | 230 | 5/30 |

GB Ratchet crimping pliers
D Kabelschuhzange
PL Szczypce do zaciskania konektorów

RUS Инструмент для обжима и зачистки проводов
CZ Kleště pro svěráni zaciskania konektorů
H Krimpelő fogó



RO Clește sertizat conectori
E Pinzas de apretar de conectores
CN 棘轮压线钳

SLIDING
CARD



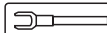

250
mm

22-10
(AWG)
0.5-6.0
mm² (DIN)

| | | |
|---|--------|---|
| YATO  | L (mm) |  |
| YT-2251 | 250 | 5/30 |

220
mm



22-10
(AWG)
0.5-6.0
mm² (DIN)

| | | |
|--|--------|---|
| YATO  | L (mm) |  |
| YT-2302 | 220 | 5/30 |





195
mm

22-14
(AWG)
0.5-2.5
mm² (DIN)

| | | |
|---|--------|---|
| YATO  | L (mm) |  |
| YT-2283 | 195 | 6/36 |

195
mm



22-14
(AWG)
0.5-2.5
mm² (DIN)

| | | |
|--|--------|---|
| YATO  | L (mm) |  |
| YT-2307 | 195 | 6/36 |



HRC
44-47



250
mm

22-8
(AWG)
0.5-10.0
mm² (DIN)

HRC
44-47

| | | |
|--|--------|---|
| YATO  | L (mm) |  |
| YT-2301 | 250 | 6/36 |

GB Ratchet crimping pliers
D Kabelschuhzange
PL Szczypce do zaciskania konektorów

RUS Инструмент для обжима и зачистки проводов
CZ Kleště pro svěření zaciskania konektorů
H Krimpelő fogó

RO Clește sertizat conectori
E Pinzas de apretar de conectores
CN 棘轮压线钳

SLIDING CARD



180 mm

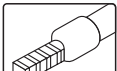

HRC 44-47

0.2-6.0 mm²

| | | |
|-------------|--------|------|
| YATO | L (mm) | |
| YT-2240 | 180 | 6/36 |

175 mm

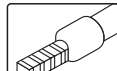

HRC 44-47

0.2-6.0 mm²

| | | |
|-------------|--------|------|
| YATO | L (mm) | |
| YT-2305 | 175 | 6/36 |

GB Crimping pliers
D Kabelschuhzange
PL Szczypce do zaciskania konektorów

RUS Инструмент для обжима и зачистки проводов
CZ Kleště pro svěření zaciskania konektorů
H Krimpelő fogó

RO Clește sertizat conectori
E Pinzas de apretar de conectores
CN 压线钳

SLIDING CARD



195 mm

CAT.5

RJ45

HRC 42-48



| | | |
|-------------|--------|-------|
| YATO | L (mm) | |
| YT-2242 | 195 | 10/60 |



200 mm



HRC 42-48

RJ45

RJ11

CAT.5

SK5

| | | |
|-------------|--------|------|
| YATO | L (mm) | |
| YT-2243 | 200 | 8/48 |



195 mm

CAT.5

RJ11

RJ12

RJ22

RJ45

HRC 42-48

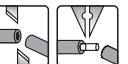

| | | |
|-------------|--------|-------|
| YATO | L (mm) | |
| YT-2244 | 195 | 10/60 |

GB Hydraulic pliers
D Manuelle Hydraulikpresse
PL Ręczna praska hydrauliczna
RUS Ручной гидравлический обжимной инструмент
CZ Ruční hydraulický lis
H Kézi hidraulikus prés
RO Presă hidraulică manuală
E Prensa hidráulica manual
CN 液压钳

BMC & COLOR SLEEVE



| YATO | crimping size range / zakres zaciskania (mm ²) | | L (mm) | pressure / nacisk (T) | crimping jaws size / rozmiar szczęk zaciskających (mm ²) | |
|----------|--|----------------|--------|-----------------------|--|---|
| | aluminium | copper / miedź | | | | |
| YT-22860 | 10-95 | 10-120 | 415 | 8 | 10; 16; 25; 35; 50; 70; 95; 120 | 4 |
| YT-22861 | 16-185 | 16-240 | 470 | 12 | 16; 25; 35; 50; 70; 95; 120; 150; 185; 240 | 3 |
| YT-22862 | 16-240 | 16-300 | 470 | 18-20 | 16; 25; 35; 50; 70; 95; 120; 150; 185; 240; 300 | 3 |

GB Crimping pliers
D Kabelschuhzange
PL Szczypce do zaciskania konektorów
RUS Инструмент для обжима и зачистки проводов
CZ Kleště pro svěrání zaciskania konektorů
H Krimpelő fogó
RO Clește sertizat conectori
E Pinzas de apretar de conectores
CN 压线钳

SLIDING
CARD

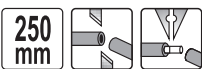

| | | | | |
|--|--|--|--|----------------|
| 20-10 (AWG) 0.5-5.0 mm ² (DIN) | 20-10 (AWG) 0.5-5.5 mm ² (DIN) | 20-10 (AWG) 0.5-5.0 mm ² (DIN) | 20-10 (AWG) 0.5-5.0 mm ² (DIN) | M2.6-M5 |
|--|--|--|--|----------------|

| | | |
|-------------|--------|-------|
| YATO | L (mm) | |
| YT-2254 | 250 | 12/48 |

GB Crimping pliers
D Kabelschuhzange
PL Szczypce do zaciskania konektorów
RUS Инструмент для обжима и зачистки проводов
CZ Kleště pro svěrání zaciskania konektorů

H Krimpelő fogó
RO Clește sertizat conectori
E Pinzas de apretar de conectores
CN 压线钳

BLISTER
CARD



| | | | | |
|--|--|--|---|---|
| 22-20 (AWG) 0.3-0.5 mm ² (DIN) | 18-14 (AWG) 1.0-2.0 mm ² (DIN) | 28-26 (AWG) 0.08-0.12 mm ² (DIN) | 26-22 (AWG) 0.12-0.3 mm ² (DIN) | 26-22 (AWG) 0.12-0.3 mm ² (DIN) |
|--|--|--|---|---|

| | | | | | | | | |
|--|--|------------------|--|---|---|--|--|--|
| 22-20 (AWG) 0.3-0.5 mm ² (DIN) | 18-14 (AWG) 1.0-2.0 mm ² (DIN) | 180 mm | 28-26 (AWG) 0.08-0.12 mm ² (DIN) | 26-22 (AWG) 0.12-0.3 mm ² (DIN) | 26-22 (AWG) 0.12-0.3 mm ² (DIN) | 14-10 (AWG) 2.0-6.0 mm ² (DIN) | 18-16 (AWG) 1.0-1.5 mm ² (DIN) | 20-22 (AWG) 0.3-0.5 mm ² (DIN) |
|--|--|------------------|--|---|---|--|--|--|

| | | |
|-------------|--------|-------|
| YATO | L (mm) | |
| YT-2255 | 180 | 10/60 |

| | | |
|-------------|--------|-------|
| YATO | L (mm) | |
| YT-2256 | 180 | 10/60 |

GB Crimping pliers
D Kabelschuhzange
PL Szczypce do zaciskania konektorów
RUS Инструмент для обжима и зачистки проводов

CZ Kleště pro svěrání zaciskania konektorů
H Krimpelő fogó
RO Clește sertizat conectori

E Pinzas de apretar de conectores
CN 压线钳

SLIDING
CARD

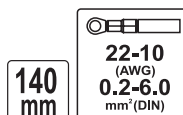

| | | |
|-------------|--------|--------|
| YATO | L (mm) | |
| YT-2271 | 140 | 20/120 |

GB Wire stripper
D Abisolierzange
PL Ściągacz izolacji
RUS Съёмник изоляции
CZ Odizolovací klejste

H Blankoló fogó
RO Decablator
E Extractor de aislado
CN 万用剥线钳

SLIDING
CARD

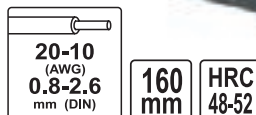
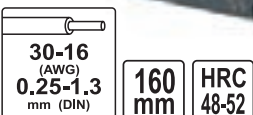
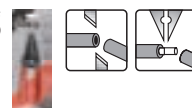

| | | |
|-------------|--------|-------|
| YATO | L (mm) | |
| YT-2266 | 160 | 10/60 |

| | | |
|-------------|--------|-------|
| YATO | L (mm) | |
| YT-2267 | 160 | 10/60 |

GB Wire stripper
D Abisolierzange
PL Ściągacz izolacji
RUS Съёмник изоляции

CZ Odizolovací klejste
H Blankoló fogó
RO Decablator

E Extractor de aislado
CN 剥线钳

SLIDING
CARD



| | | | | | |
|------------------|---|--|----------------|----------------------------------|-------------|
| 210 mm | 20-8 (AWG) 0.5-6.0 mm ² (DIN) | 22-10 (AWG) 0.5-6.0 mm ² (DIN) | M2.5-M5 | # 310 # 311 # 410 # 411 | RG 6 |
|------------------|---|--|----------------|----------------------------------|-------------|

| | | |
|-------------|--------|-------|
| YATO | L (mm) | |
| YT-2277 | 210 | 10/60 |

GB Wire stripper
 D Abisolierzange
 PL Ściągacz izolacji

RUS Съёмник изоляции
 CZ Odizolovací klejte
 H Blankolo fogo

RO Decablator
 E Extractor de aislado
 CN 剥线钳

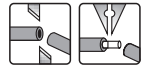

205 mm

HRC 50-53

RG 6

22-10 (AWG) 0.64-2.6 mm² (DIN)

22-10 (AWG) 0.64-2.6 mm² (DIN)

M3-M5

SLIDING CARD

COLOR BOX

12 PCS

| YATO | L (mm) | PCS packing | |
|---------|--------|-------------|----|
| YT-2292 | 205 | 12 | 72 |



240 mm

HRC 46-50

22-10 (AWG) 1.5-6.0 mm² (DIN)

22-10 (AWG) 1.5-6.0 mm² (DIN)

22-10 (AWG) 0.75-6.0 mm² (DIN)

M2.6-M5

SLIDING CARD

COLOR BOX

12 PCS

| YATO | L (mm) | PCS packing | |
|----------|--------|-------------|--|
| YT-22930 | 240 | 12/48 | |

7



215 mm

HRC 50-53

RG 6

18-10 (AWG) 1.0-2.5 mm² (DIN)

7-8 (mm)

M2.6-M5

SLIDING CARD

COLOR BOX

12 PCS

| YATO | L (mm) | PCS packing | |
|---------|--------|-------------|----|
| YT-2293 | 215 | 12 | 72 |



22-10 (AWG) 0.64-2.6 mm² (DIN)

165 mm

HRC 50-53

SLIDING CARD

COLOR BOX

12 PCS

| YATO | L (mm) | PCS packing | |
|---------|--------|-------------|-----|
| YT-2294 | 165 | 12 | 120 |



220 mm

HRC 50-53

7 (mm)

22-10 (AWG) 0.64-2.6 mm² (DIN)

M3-M5

SLIDING CARD

COLOR BOX

12 PCS

| YATO | L (mm) | PCS packing | |
|---------|--------|-------------|----|
| YT-2295 | 220 | 12 | 72 |



20-10 (AWG) 0.8-2.6 mm (DIN)

160 mm

HRC 48-52

SLIDING CARD

| YATO | L (mm) | PCS packing | |
|---------|--------|-------------|--|
| YT-2319 | 160 | 10/60 | |



22-10 (AWG) 0.34-6.0 mm² (DIN)

140 mm

SLIDING CARD

COLOR BOX

12 PCS

| YATO | L (mm) | PCS packing | |
|---------|--------|-------------|--|
| YT-2272 | 140 | 20/120 | |



20-10 (AWG) 0.8-2.6 mm (DIN)

M3-M4

180 mm

HRC 45-49

SLIDING CARD

| YATO | L (mm) | PCS packing | |
|---------|--------|-------------|--|
| YT-2273 | 180 | 10/60 | |



22-10 (AWG) 0.64-2.6 mm² (DIN)

M4-M5

185 mm

HRC 50-53



SLIDING CARD

COLOR BOX

12 PCS

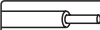
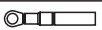
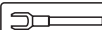

| YATO | L (mm) | PCS packing | |
|---------|--------|-------------|-----|
| YT-2290 | 185 | 12 | 120 |

- GB** Universal wire stripper
& Ratchet crimping pliers
D Multifunktion Abisolierzange
& Kabelschuhklemmzange
PL Uniwersalny ściągacz izolacji
i szczypce do zaciskania konektorów
RUS Инструмент для снятия изоляции
и зажима проводов
CZ Univerzální odizolovací kleště
& Kleště pro svěráni zaciskania
konektorů
H Blankolo fogo & Krimpelő fogó
RO Decablator universal
& Clește sertizat conectori
E Extractor de aislado
multifunción
CN 万用剥线钳

| | | | |
|---|---|---|---|
| 205 mm | HRC 52-57 |  24-10 (AWG) 0.2-6.0 mm² (DIN) |  22-14 (AWG) 0.5-2.5 mm² (DIN) |
|  22-10 (AWG) 1.5-6.0 mm² (DIN) |  12-10 (AWG) 4.0-6.0 mm² (DIN) | 7-8 mm | |





HALF DOUBLE BLISTER

| | | |
|---|--------|---|
| YATO  | L (mm) |  |
| YT-2270 | 205 | 5/30 |





SLIDING CARD



| | | |
|---|--------|---|
| YATO  | L (mm) |  |
| YT-2313 | 205 | 5/30 |

- GB** Universal wire stripper
& Ratchet crimping pliers
D Multifunktion Abisolierzange
& Kabelschuhklemmzange
PL Uniwersalny ściągacz izolacji
i szczypce do zaciskania konektorów
RUS Инструмент для снятия изоляции
и зажима проводов
CZ Univerzální odizolovací kleště
& Kleště pro svěráni zaciskania
konektorů
H Blankolo fogo & Krimpelő fogó
RO Decablator universal
& Clește sertizat conectori
E Extractor de aislado multifunción
CN 剥线钳



SLIDING CARD

| | | |
|---------------|---|---|
| 210 mm |  22-10 (AWG) 0.5-6.0 mm² (DIN) |  24-10 (AWG) 0.2-6.0 mm² (DIN) |
|---------------|---|---|



| | | |
|---|--------|---|
| YATO  | L (mm) |  |
| YT-2278 | 210 | 10/60 |



- GB** Automatic wire stripper
D Automatische Abisolierzange
PL Automatyyczny ściągacz izolacji
RUS Клещи для удаления изоляции
CZ Automatický stahovač izolace

- H** Automatikus szigeteléslehúzó
RO Clește automat pt. desizolat
E Pelacables automatico
CN 万用剥线钳



SLIDING CARD





| | |
|---|---|
| 175 mm |  |
|  10 mm (max) | 65Mn HRC55 |



| | | |
|---|--------|---|
| YATO  | L (mm) |  |
| YT-2268 | 175 | 10/60 |





| | |
|---|---|
| 195 mm |  |
|  SK5 |  20-10 (AWG) 0.5-6.0 mm² (DIN) |



| | | |
|---|--------|---|
| YATO  | L (mm) |  |
| YT-2275 | 195 | 10/60 |





| | |
|---|---|
| 170 mm |  |
|  SK5 |  18-12 (AWG) 1.0-3.2 mm² (DIN) |

| | | |
|---|--------|---|
| YATO  | L (mm) |  |
| YT-2276 | 170 | 8/48 |





| | |
|---|---|
| 185 mm |  |
|  SK5 |  18-12 (AWG) 1.0-3.2 mm² (DIN) |

| | | |
|---|--------|---|
| YATO  | L (mm) |  |
| YT-2316 | 185 | 8/48 |

- GB** Wire stripper
D Abisolierzange
PL Ściągacz izolacji
RUS Съёмник изоляции
CZ Odizolovací kleště
H Blankolo fogo
RO Decablator
E Extractor de aislado
CN 剥线钳



SLIDING CARD

| | |
|---|---|
| 125 mm |  |
|  SK5 |  20-10 (AWG) 0.5-6.0 mm² (DIN) |

| | | |
|---|--------|---|
| YATO  | L (mm) |  |
| YT-2274 | 125 | 15/90 |

| | |
|-------------|--------------|
| RG 6 | RG 59 |
|-------------|--------------|

GB Electrical cutter
D Seitenschneider
PL Obcinak elektryczny
RUS Инструмент для обрезки проводов
CZ Elektrické upichovky
H Kábelvágó
RO Clește tăietor - electrician

E Cortacables eléctricos
CN 电子斜嘴钳



20-18 (AWG)
0.5-1.5 mm² (DIN)

125 mm



| | | |
|-------------|--------|--------|
| YATO | L (mm) | |
| YT-2260 | 125 | 15/150 |

125 mm



| | | |
|-------------|--------|--------|
| YATO | L (mm) | |
| YT-2261 | 125 | 15/150 |



125 mm



| | | |
|-------------|--------|--------|
| YATO | L (mm) | |
| YT-2262 | 125 | 20/120 |

GB Electrical cutter
D Seitenschneider
PL Obcinak elektryczny
RUS Инструмент для обрезки проводов
CZ Elektrické upichovky
H Kábelvágó
RO Clește tăietor - electrician
E Cortacables eléctricos
CN 电子斜嘴钳

130 mm



HRC 55-57



SLIDING CARD

| | | |
|-------------|--------|--------|
| YATO | L (mm) | |
| YT-2263 | 130 | 12/120 |



SLIDING CARD



12 PCS COLOR BOX

| | | | |
|-------------|--------|-------------|-----|
| YATO | L (mm) | PCS packing | |
| YT-2264 | 130 | 12 | 120 |

GB Cable cutter
D Kabelschere
PL Szczypce do cięcia przewodów
RUS Кабелерезы
CZ Elektrické upichovky
H Kábelvágó

RO Patent tăietor pt. electricie
E Tijeras para cables
CN 电缆断线钳

SLIDING CARD



3.5 mm

170 mm



SK5

| | | |
|-------------|--------|-------|
| YATO | L (mm) | |
| YT-2279 | 170 | 10/60 |

GB Cable stripper
D Kabelmesser
PL Nożyk do kabli

RUS Нож кабельный
CZ Nůž na kabele
H Kábelkés

RO Cuțitaș pt. cabluri
E Cuchillo
CN 电缆剥线钳

Ø mm
8-28



SLIDING CARD



| | | |
|-------------|--------|--------|
| YATO | L (mm) | |
| YT-2280 | 190 | 10/100 |

GB Electrician scissors
D Elektrische Schere
PL Nożyczki dla elektryków
RUS Ножницы универсальные
CZ Elektrické nůžky

H Univerzális olló
RO Foarfece - electrician
E Tijeras eléctricos
CN 电工剪

140 mm

STAINLESS STEEL
STAL
NERDZEWA

HRC 52-56



SLIDING CARD



| | | |
|-------------|--------|--------|
| YATO | L (mm) | |
| YT-1974 | 140 | 12/120 |

GB Ratchet cable cutter
D Ratschenkabelschneider
PL Nożyce zapadkowe do kabli
RUS Кабелерез секторный
CZ Kleště na kabely, rohátka se západkou

H Racsnis kábelvágó
RO Clește pt. taiat cablu cu clichet
E Cortacables de carraca
CN 棘轮电缆剪

COLOR BOX



Cu/Al
CABLE
KABEL

60Si2Mn

HRC 50
CUTTING BLADE
OSTRZE TRĄCIE



| | | | |
|-------------|---|--------|----|
| YATO | cutting range / max. przekrój cięcia (mm ²) | L (mm) | |
| YT-18600 | 240 | 300 | 10 |



| | | | |
|-------------|---|--------|----|
| YATO | cutting range / max. przekrój cięcia (mm ²) | L (mm) | |
| YT-18602 | 380 | 380 | 10 |

GB Cable cutter
D Kabelschere
PL Nożyce do kabli
RUS Кабелерезы
CZ Elektrické upichovky

H Kábelvágó
RO Patent tăietor pt. electricie
E Tijeras para cables
CN 电缆剪

COLOR BOX



STEE
L



| | | | |
|-------------|---|--------|----|
| YATO | cutting range / max. przekrój cięcia (mm ²) | L (mm) | |
| YT-18610 | 125 | 370 | 20 |
| YT-18611 | 250 | 580 | 10 |
| YT-18612 | 500 | 770 | 5 |

GB Voltage tester
D Spannungsprüfer
PL Próbnik napięcia
RUS Отвёртка с передачей

CZ Zkoušeč napětí
H Fáziskereső
RO Creion de tensiune

E Comprobador de corriente
CN VDE 测电笔

PLASTIC
HANGER



125-250
V~



| YATO | ⊖ | L (mm) | 📦 |
|---------|---|--------|--------|
| YT-2830 | 4 | 190 | 12/144 |

GB Digital voltage tester
D Spannungsprüfer
PL Uniwersalny tester elektryczny
RUS Отвёртка с передачей
CZ Zkoušeč napětí

H Fáziskereső
RO Creion de tensiune
E Comprobador de corriente
CN 多功能测电笔

SLIDING
CARD



1.5-9 V
LED

50-500
Hz

70-250
V

70-600
V

POWER
ZASILANIE
2x1.5 V
LR41
BATTERY*



| YATO | 📦 |
|---------|-------|
| YT-2864 | 6/120 |

GB Digital voltage tester
D Spannungsprüfer
PL Uniwersalny tester elektryczny
RUS Отвёртка с передачей
CZ Zkoušeč napětí
H Fáziskereső
RO Creion de tensiune
E Comprobador de corriente
CN 测电笔

SLIDING
CARD



1.5-9 V
LED

50-500
Hz

70-250
V

70-1000
V

POWER
ZASILANIE
2x1.5 V
LR44
BATTERY*

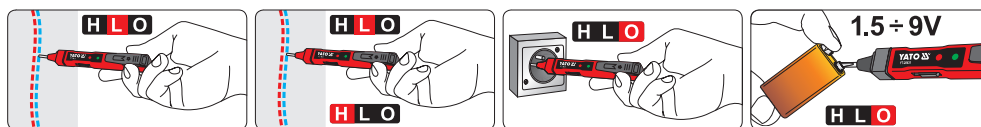

| YATO | 📦 |
|----------|-------|
| YT-28631 | 6/120 |

GB Digital voltage tester
D Digitaler-Spannungsprüfer
PL Wskaźnik elektryczny
RUS Тестер напряжения цифровой
CZ Zkoušečka napětí digitální

H Digitális voltmérő
RO Tester digital pt. tensiune electrica
E Indicador eléctrico
CN 数显测电笔

SLIDING
CARD



12-250
V

50-500
Hz

LCD
DISPLAY

NO BATTERY
NEEDED
NIE POTRZEBUJE
BATERII



| YATO | 📦 |
|---------|--------|
| YT-2861 | 20/500 |



| YATO | 📦 |
|---------|--------|
| YT-2862 | 20/500 |



| YATO | 📦 |
|---------|-------|
| YT-2863 | 6/120 |

GB Digital universal multimeter
 D Universell digital Messgerät
 PL Cyfrowy miernik uniwersalny
 RUС Универсальный цифровой измеритель
 CZ Digitální multimetr univerzální
 H Digitális multiméter
 RO Multimetru digital universal
 E Manómetro digital universal
 CN 数字万用表

| | | |
|------------------|------------------|-------------------------------|
| U 0-500 ~V | U 0-500 ~V | I 0-5 A |
| R 0-2 MΩ | | h _{FE} PNP NPN |
| | | |

| | | | | | |
|-------------------|-------------------------------|----------------------|-----------------|-----------------|-----------------|
| U 0-1000 ~V | U 0-750 ~V | I 0-10 A | I 0-10 ~A | R 0-20 MΩ | C 0-20 μF |
| | h _{FE} PNP NPN | AUTO POWER OFF | | | |

| | | | | | |
|----------------------|------------------|-------------------------------|---------------------------------|----------------------|-------------------|
| U 0-600 ~V | U 0-600 ~V | I 0-10 A | I 0-10 ~A | R 0-20 MΩ | C 0-1000 μF |
| T -20+ +1000°C | | h _{FE} PNP NPN | AUTO RANGE AUTO ZAKRES | AUTO POWER OFF | |



COLOR BOX



COLOR BOX



COLOR BOX

| | |
|-------------|----|
| YATO | |
| YT-73080 | 50 |

| | |
|-------------|----|
| YATO | |
| YT-73082 | 30 |

| | |
|-------------|----|
| YATO | |
| YT-73084 | 44 |

| | | | | | |
|------------------|------------------|------------------|----------------------|----------------------|---------------------------------|
| | U 0-600 ~V | U 0-600 ~V | I 0-10 A | I 0-10 ~A | R 0-40 MΩ |
| C 0-100 μF | f 100 kHz | | T -20+ +1000°C | | AUTO RANGE AUTO ZAKRES |
| | | | | AUTO POWER OFF | |

| | | | | | |
|--------|------------------|---------------------------------|----------------------|----------------------|-----------------|
| 5 in 1 | U 0-600 ~V | U 0-600 ~V | I 0-10 A | I 0-10 ~A | R 0-40 MΩ |
| 5 w 1 | C 0-100 μF | f 200 kHz | | T -20+ +1000°C | |
| | | AUTO RANGE AUTO ZAKRES | AUTO POWER OFF | | |

| | | | | | |
|-------------------|-------------------|------------------|----------------------|----------------------|---------------------------------|
| TRUE RMS | U 0-600 ~V | U 0-600 ~V | I 0-10 A | I 0-10 ~A | R 0-60 MΩ |
| C 0-4000 μF | f 9.999 MHz | | T -20+ +1000°C | | AUTO RANGE AUTO ZAKRES |
| | | | | AUTO POWER OFF | |



NYLON CASE & COLOR BOX



NYLON CASE & COLOR BOX



COLOR BOX

| | |
|-------------|----|
| YATO | |
| YT-73086 | 24 |

| | |
|-------------|----|
| YATO | |
| YT-73087 | 24 |

| | |
|-------------|----|
| YATO | |
| YT-73088 | 20 |



| | | | |
|----------------------|------------------|---------------------------------|----------------------|
| U 0-600 ~V | U 0-600 ~V | I 0-600 ~A | R 0-200 MΩ |
| T -20+ +1000°C | | AUTO RANGE AUTO ZAKRES | AUTO POWER OFF |
| | | | |





NYLON CASE & COLOR BOX

| | |
|-------------|----|
| YATO | |
| YT-73091 | 20 |

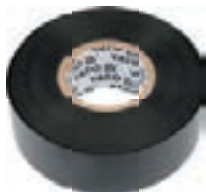
GB Insulation tape *RUS* Изолента *RO* Banda izolatoare
D Isolierband *CZ* Izolační páska *E* Cinta aislante
PL Taśma elektroizolacyjna *H* Szigetelőszalag *CN* 绝缘胶带





EN60454-3-1-1/F-PVC/60/R-Tp
 12 mm x 10 m x 0.13 mm
 DIELECTRIC STRENGTH / WYTRZYMAŁOŚĆ DIELEKTRYCZNA > 40 Kv / mm
 ELONGATION / WYDŁUŻENIE > 125%
 FLAME TEST / TEST OGNIOWY < 1 s
 STORE TEMPERATURE / TEMPERATURA SKŁADOWANIA +10°C ~ +40°C
 USING TEMPERATURE / TEMPERATURA UŻYTKOWANIA +5°C ~ +50°C

|  | dimensions / wymiary |  |
|---|------------------------|---|
| YT-8152 | 12 mm x 10 m x 0.13 mm | 96/384 |





EN60454-3-1-1/F-PVC/60/R-Tp
 19 mm x 20 m x 0.13 mm
 DIELECTRIC STRENGTH / WYTRZYMAŁOŚĆ DIELEKTRYCZNA > 40 Kv / mm
 ELONGATION / WYDŁUŻENIE > 125%
 FLAME TEST / TEST OGNIOWY < 1 s
 STORE TEMPERATURE / TEMPERATURA SKŁADOWANIA +10°C ~ +40°C
 USING TEMPERATURE / TEMPERATURA UŻYTKOWANIA +5°C ~ +50°C

|  | dimensions / wymiary |  |
|---|------------------------|---|
| YT-8166 | 19 mm x 20 m x 0.13 mm | 72/288 |



10
PCS



EN60454-3-1-1/F-PVC/60/R-Tp
 12 mm x 10 m x 0.13 mm
 DIELECTRIC STRENGTH / WYTRZYMAŁOŚĆ DIELEKTRYCZNA > 40 Kv / mm
 ELONGATION / WYDŁUŻENIE > 125%
 FLAME TEST / TEST OGNIOWY < 1 s
 STORE TEMPERATURE / TEMPERATURA SKŁADOWANIA +10°C ~ +40°C
 USING TEMPERATURE / TEMPERATURA UŻYTKOWANIA +5°C ~ +50°C

|  | dimensions / wymiary |  |
|---|------------------------|---|
| YT-8156 | 12 mm x 10 m x 0.13 mm | 10/40 |





10
PCS

EN60454-3-1-1/F-PVC/60/R-Tp
 19 mm x 20 m x 0.13 mm
 DIELECTRIC STRENGTH / WYTRZYMAŁOŚĆ DIELEKTRYCZNA > 40 Kv / mm
 ELONGATION / WYDŁUŻENIE > 125%
 FLAME TEST / TEST OGNIOWY < 1 s
 STORE TEMPERATURE / TEMPERATURA SKŁADOWANIA +10°C ~ +40°C
 USING TEMPERATURE / TEMPERATURA UŻYTKOWANIA +5°C ~ +50°C

|  | dimensions / wymiary |  |
|---|------------------------|---|
| YT-8173 | 19 mm x 20 m x 0.13 mm | 6/24 |





EN60454-3-1-1/F-PVC/60/R-Tp
 15 mm x 20 m x 0.13 mm
 DIELECTRIC STRENGTH / WYTRZYMAŁOŚĆ DIELEKTRYCZNA > 40 Kv / mm
 ELONGATION / WYDŁUŻENIE > 125%
 FLAME TEST / TEST OGNIOWY < 1 s
 STORE TEMPERATURE / TEMPERATURA SKŁADOWANIA +10°C ~ +40°C
 USING TEMPERATURE / TEMPERATURA UŻYTKOWANIA +5°C ~ +50°C

|  | dimensions / wymiary |  |
|---|------------------------|---|
| YT-8159 | 15 mm x 20 m x 0.13 mm | 72/288 |





EN60454-3-1-1/F-PVC/60/R-Tp
 25 mm x 20 m x 0.19 mm
 DIELECTRIC STRENGTH / WYTRZYMAŁOŚĆ DIELEKTRYCZNA > 80 Kv / mm
 ELONGATION / WYDŁUŻENIE > 125%
 FLAME TEST / TEST OGNIOWY < 1 s
 STORE TEMPERATURE / TEMPERATURA SKŁADOWANIA +10°C ~ +40°C
 USING TEMPERATURE / TEMPERATURA UŻYTKOWANIA +5°C ~ +50°C

|  | dimensions / wymiary |  |
|---|------------------------|---|
| YT-8174 | 25 mm x 20 m x 0.19 mm | 48/192 |





EN60454-3-1-1/F-PVC/60/R-Tp
 19 mm x 20 m x 0.13 mm
 DIELECTRIC STRENGTH / WYTRZYMAŁOŚĆ DIELEKTRYCZNA > 40 Kv / mm
 ELONGATION / WYDŁUŻENIE > 125%
 FLAME TEST / TEST OGNIOWY < 1 s
 STORE TEMPERATURE / TEMPERATURA SKŁADOWANIA +10°C ~ +40°C
 USING TEMPERATURE / TEMPERATURA UŻYTKOWANIA +5°C ~ +50°C

|  | dimensions / wymiary |  |
|---|------------------------|---|
| YT-8165 | 19 mm x 20 m x 0.13 mm | 72/288 |



EN60454-3-1-1/F-PVC/60/R-Tp
 50 mm x 33 m x 0.19 mm
 DIELECTRIC STRENGTH / WYTRZYMAŁOŚĆ DIELEKTRYCZNA > 80 Kv / mm
 ELONGATION / WYDŁUŻENIE > 125%
 FLAME TEST / TEST OGNIOWY < 1 s
 STORE TEMPERATURE / TEMPERATURA SKŁADOWANIA +10°C ~ +40°C
 USING TEMPERATURE / TEMPERATURA UŻYTKOWANIA +5°C ~ +50°C

|  | dimensions / wymiary |  |
|---|------------------------|---|
| YT-8177 | 50 mm x 33 m x 0.19 mm | 48 |

8

**Hammers, chisels,
punches & axes**
**Młotki, dłuta,
przecinaki i siekiery**



| | | |
|---|---|-----|
| Machinist hammers Młotki ślusarskie |  | 144 |
|---|---|-----|

| | | |
|---|---|-----|
| Dead blow hammers Młotki bezodrzutowe |  | 146 |
|---|---|-----|

| | | |
|--|---|-----|
| Stoning hammers Młotki kamieniarskie |  | 144 |
|--|---|-----|

| | | |
|---|---|-----|
| Ball pein hammers & sets Młotki blacharskie i zestawy |  | 147 |
|---|---|-----|

| | | |
|--|---|-----|
| Hammers with tubular steel handle Młotki z trzonkiem rurowym |  | 145 |
|--|---|-----|

| | | |
|--|---|---------|
| Chisels, cold chisels & punches Dłuta, przecinaki i przebijaki |  | 148-150 |
|--|---|---------|

| | |
|---|-----|
| Claw hammers Młotki szewskie | 145 |
| Roofing hammers Młotki ciesielskie | 145 |
| Mason's hammers Młotki murarskie | 145 |
| Plasterer's hatchets Toporki tynkarskie | 145 |

| | |
|--|-----|
| Wood chisels & sets Dłuta stolarskie i zestawy | 148 |
| Cold chisels Przecinaki | 148 |
| Punches Przebijaki | 148 |
| Pin punches Wybijaki | 149 |
| Punches Punktaki | 149 |
| Cold chisel & punch sets Zestawy przecinaków i punktaków | 149 |

| | | |
|--|---|-----|
| Fully drop forged hammers Młotki monolityczne kute |  | 145 |
|--|---|-----|

| | | |
|------------------------------|--|-----|
| Wrecking bars Łomy |  | 151 |
|------------------------------|--|-----|

| | |
|--|-----|
| Claw hammers Młotki szewskie | 145 |
| Roofing hammers Młotki ciesielskie | 145 |
| Mason's hammers Młotki murarskie | 145 |

| | | |
|-------------------------|---|-----|
| Axes Siekiery |  | 151 |
|-------------------------|---|-----|

| | | |
|--|---|-----|
| Rubber mallets Młotki gumowe |  | 146 |
|--|---|-----|

GB Machinist hammer
D Schlosserhammer
PL Młotek ślusarski

RUS Молоток слесарный
CZ Zámečnické kladívko
H Vaskalapács

RO Ciocan de lăcătuşerie
E Martillo
CN 钳工锤

DIN
1041

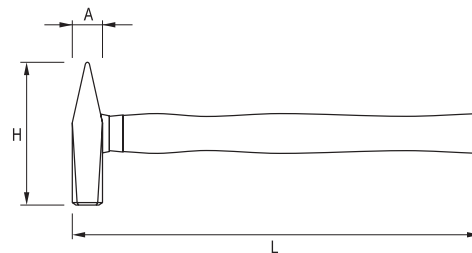

| YATO | m (g) | L (mm) | A (mm) | H (mm) | |
|---------|-------|--------|--------|--------|--------|
| YT-4491 | 100 | 260 | 15 | 80 | 12/120 |
| YT-4492 | 200 | 280 | 20 | 93 | 6/60 |
| YT-4493 | 300 | 300 | 21 | 103 | 6/60 |
| YT-4494 | 400 | 310 | 23 | 111 | 6/48 |
| YT-4495 | 500 | 320 | 26 | 118 | 6/36 |

| YATO | m (g) | L (mm) | A (mm) | H (mm) | |
|---------|-------|--------|--------|--------|------|
| YT-4496 | 600 | 330 | 28 | 119 | 6/36 |
| YT-4497 | 800 | 350 | 31 | 125 | 6/24 |
| YT-4498 | 1000 | 360 | 35 | 132 | 6/24 |
| YT-4499 | 1500 | 380 | 40 | 143 | 6/12 |
| YT-4500 | 2000 | 400 | 45 | 153 | 6/12 |

8

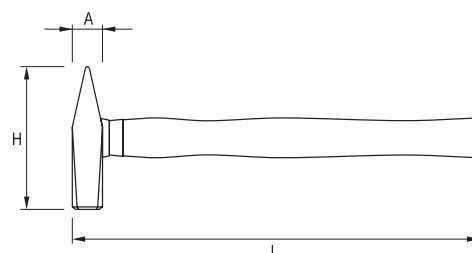

| YATO | m (g) | L (mm) | A (mm) | H (mm) | |
|---------|-------|--------|--------|--------|--------|
| YT-4501 | 100 | 260 | 15 | 82 | 12/120 |
| YT-4502 | 200 | 280 | 19 | 95 | 6/60 |
| YT-4503 | 300 | 300 | 23 | 105 | 6/60 |
| YT-4504 | 400 | 310 | 25 | 112 | 6/48 |
| YT-4505 | 500 | 320 | 27 | 118 | 6/36 |

| YATO | m (g) | L (mm) | A (mm) | H (mm) | |
|---------|-------|--------|--------|--------|------|
| YT-4506 | 600 | 330 | 29 | 122 | 6/36 |
| YT-4507 | 800 | 350 | 33 | 135 | 6/24 |
| YT-4508 | 1000 | 360 | 36 | 135 | 6/24 |
| YT-4509 | 1500 | 380 | 42 | 145 | 6/12 |
| YT-4510 | 2000 | 400 | 47 | 155 | 6/12 |

GB Safety stoning hammer
D Faustel
PL Młotek kamieniarski

RUS Молоток каменщика
CZ Palička kovová
H Kőtörő kalapács

RO Ciocan pt. zidarie
E Martillo
CN 石工锤

DIN
6475

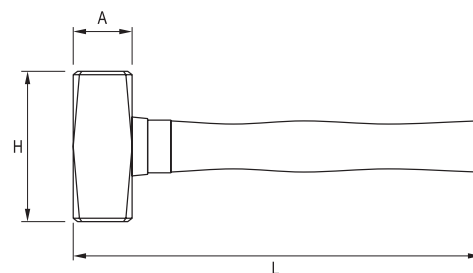

| YATO | m (g) | L (mm) | A (mm) | H (mm) | |
|---------|-------|--------|--------|--------|------|
| YT-4550 | 1000 | 260 | 40 | 95 | 6/24 |
| YT-4551 | 1250 | 260 | 43 | 100 | 6/24 |

| YATO | m (g) | L (mm) | A (mm) | H (mm) | |
|---------|-------|--------|--------|--------|------|
| YT-4552 | 1500 | 280 | 45 | 110 | 6/12 |
| YT-4553 | 2000 | 300 | 50 | 120 | 6/12 |

GB Claw hammer
D Schusterhammer
PL Młotek szewski
RUS Молоток гвоздодёр
CZ Ševcovské kladívko

H Cipész kalapács
RO Ciocan de cizmărie
E Martillo sacador
CN 羊角锤



- high quality steel handle
- forged carbon steel head hardened and tempered
- stalowa rączka
- główka ze stali węglowej, kuta, ulepszona cieplnie

| YATO | m (g) | L (mm) | A (mm) | H (mm) | |
|---------|-------|--------|--------|--------|------|
| YT-4560 | 450 | 318 | 30 | 130 | 6/24 |

GB Roofing hammer
D Latthammer Geschmiedet
PL Młotek ciesielski
RUS Молоток желязняцка

CZ Tesařské kladívko
H Ácskalapács
RO Ciocan de dulgherie



- high quality steel handle
- forged carbon steel head hardened and tempered
- stalowa rączka
- główka ze stali węglowej, kuta, ulepszona cieplnie

| YATO | m (g) | L (mm) | A (mm) | H (mm) | |
|---------|-------|--------|--------|--------|------|
| YT-4561 | 600 | 318 | 25x25 | 165 | 6/24 |

GB Mason's hammer, type B
D Berliner Mauerhammer
PL Młotek murarski berliński
RUS Молоток каменщика широкий

H Kőműves kalapács, berlini típus
RO Ciocan de zidărie tip Berlin
E Martillo de albañil de Berlín
CN B型泥工锤

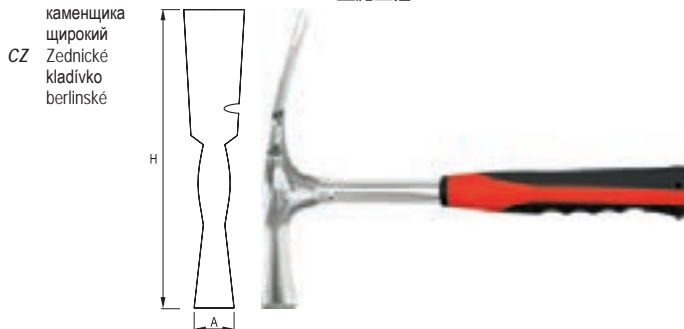

- high quality steel handle
- forged carbon steel head hardened and tempered
- stalowa rączka
- główka ze stali węglowej, kuta, ulepszona cieplnie

| YATO | m (g) | L (mm) | A (mm) | H (mm) | |
|---------|-------|--------|--------|--------|------|
| YT-4562 | 600 | 315 | 24x23 | 200 | 6/24 |

GB Mason's hammer, type R
D Mauerhammer Rheinische Form
PL Młotek murarski reński
RUS Молоток каменщика узкий
CZ Zednické kladívko renské

H Kőműves kalapács, rajnai típus
RO Ciocan de zidărie (tip ren)
E Martillo de albañil de Rin
CN R型泥工锤



- high quality steel handle
- forged carbon steel head hardened and tempered
- stalowa rączka
- główka ze stali węglowej, kuta, ulepszona cieplnie

| YATO | m (g) | L (mm) | A (mm) | H (mm) | |
|---------|-------|--------|--------|--------|------|
| YT-4563 | 600 | 315 | 23x23 | 170 | 6/24 |

GB Plasterer's hatchet
D Gipserbeil
PL Toporek tynkarski
RUS Топор штукатурный

CZ Omitáči sekyrka
H Kőműves szekerce
RO Toporaș de tencuit
E Hacha enlucido
CN 多用斧



- high quality steel handle
- forged carbon steel head hardened and tempered
- stalowa rączka
- główka ze stali węglowej, kuta, ulepszona cieplnie

| YATO | m (g) | L (mm) | A (mm) | H (mm) | |
|---------|-------|--------|--------|--------|------|
| YT-4564 | 600 | 315 | 25x20 | 175 | 6/24 |

GB Claw hammer
D Schusterhammer
PL Młotek szewski
RUS Молоток гвоздодёр
CZ Ševcovské kladívko

H Cipész kalapács
RO Ciocan de cizmărie
E Martillo sacador
CN 连体羊角锤



- high quality steel handle
- forged carbon steel head hardened and tempered
- stalowa rączka
- główka ze stali węglowej, kuta, ulepszona cieplnie

| YATO | m (g) | L (mm) | A (mm) | H (mm) | |
|---------|-------|--------|--------|--------|------|
| YT-4570 | 450 | 315 | 30 | 130 | 6/24 |

GB Roofing hammer
D Latthammer Geschmiedet
PL Młotek ciesielski
RUS Молоток желязняцка
CZ Tesařské kladívko

H Ácskalapács
RO Ciocan de dulgherie
E Martillo techumbre
CN 连体独角锤



- high quality steel handle
- forged carbon steel head hardened and tempered
- stalowa rączka
- główka ze stali węglowej, kuta, ulepszona cieplnie

| YATO | m (g) | L (mm) | A (mm) | H (mm) | |
|---------|-------|--------|--------|--------|------|
| YT-4571 | 600 | 331 | 25x25 | 165 | 6/24 |

GB Mason's hammer, type R
D Mauerhammer Rheinische Form
PL Młotek murarski reński
RUS Молоток каменщика узкий
CZ Zednické kladívko renské

H Kőműves kalapács, rajnai típus
RO Ciocan de zidărie (tip ren)
E Martillo de albañil de Rin
CN 连体R型泥工锤



- high quality steel handle
- forged carbon steel head hardened and tempered
- stalowa rączka
- główka ze stali węglowej, kuta, ulepszona cieplnie

| YATO | m (g) | L (mm) | A (mm) | H (mm) | |
|---------|-------|--------|--------|--------|------|
| YT-4573 | 600 | 382 | 25x24 | 158 | 6/24 |

- GB Rubber mallet with fibreglass, TPR handle
 D Gummihammer mit Fiberglasstiel
 PL Młotek gumowy z trzonkiem z włókna szklanego
 RUS Киянка резиновая со стеклопластиковой ручкой
 CZ Pryžové kladívko

- H Gumikalapács
 RO Ciocan de cauciuc
 E Mazo de goma
 CN 纤维柄橡胶锤



| YATO | m (g) | L (mm) | Ø (mm) | H (mm) | |
|---------|-------|--------|--------|--------|------|
| YT-4594 | 440 | 340 | 50 | 87.5 | 6/36 |

- GB Dead blow mallet
 D Rückschlagsfreier Schonhammer
 PL Młotek bezodrzutowy
 RUS Молоток безинерционный
 CZ Palička nárazová plněná celogumová
 H Visszarúgás mentes gumikalapács
 RO Ciocan cu absorbție
 E Martillo sin reacción
 CN 防震无回弹橡胶锤

PU

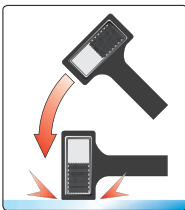

| YATO | m (g) | L (mm) | Ø (mm) | H (mm) | |
|---------|-------|--------|--------|--------|------|
| YT-4620 | 740 | 300 | 44.5 | 100.0 | 4/24 |
| YT-4622 | 900 | 336 | 53.5 | 100.0 | 4/24 |
| YT-4623 | 1300 | 350 | 59.0 | 118.5 | 3/12 |

- GB PU & nylon heads mallet
 D Schonhammer mit PU & Nylon-Schlagkopf
 PL Młotek blacharski
 RUS Молоток рихтовочный
 CZ Palička klempířská
 H Vaskalapács
 RO Ciocan tinichigerie cap PU / nylon
 E Martillo chapista
 CN 木柄安装锤



PU NYLON

- GB Rubber mallet with wooden handle
 D Gummihammer mit Holzstiel
 PL Młotek gumowy z drewnianym trzonkiem
 RUS Молоток резиновый
 CZ Pryžové kladívko

- H Gumikalapács
 RO Ciocan de cauciuc
 E Mazo de goma
 CN 木柄橡胶锤



| YATO | m (g) | L (mm) | Ø (mm) | H (mm) | |
|---------|-------|--------|--------|--------|-------|
| YT-4600 | 230 | 259 | 44 | 71.0 | 12/48 |
| YT-4601 | 340 | 291 | 49 | 79.5 | 12/48 |
| YT-4602 | 370 | 300 | 50 | 87.5 | 6/36 |
| YT-4603 | 580 | 341 | 58 | 96.0 | 6/36 |
| YT-4604 | 780 | 341 | 63 | 117.0 | 6/36 |
| YT-4605 | 980 | 345 | 72 | 122.0 | 6/24 |

- GB Dead blow mallet
 D Rückschlagsfreier Schonhammer
 PL Młotek bezodrzutowy
 RUS Молоток безинерционный
 CZ Palička nárazová plněná celogumová

- H Visszarúgás mentes gumikalapács
 RO Ciocan cu absorbție
 E Martillo sin reacción
 CN 尼龙安装锤

PU



| YATO | m (g) | L (mm) | Ø (mm) | H (mm) | |
|---------|-------|--------|--------|--------|-------|
| YT-4624 | 265 | 318 | 30.0 | 94 | 10/40 |
| YT-4625 | 430 | 350 | 40.0 | 100 | 6/36 |
| YT-4626 | 490 | 348 | 45.0 | 110 | 6/36 |

- GB PU head for mallet
 D Polyurethan Schlagkopf
 PL Końcówka PU do młotka
 RUS Наконечник молотка из полиуретана
 CZ Náhradní koncovka k paličce PU
 H PU kalapácsfej cserélhető
 RO Cap PU pt. ciocan tinichigerie
 E Cabeza PU para martillo chapista
 CN PU软头

PU

SOFT
MIĘKKA



| YATO | Ø (mm) | for / dla | |
|---------|--------|-----------|------|
| YT-4635 | 22 | YT-4630 | 6/60 |
| YT-4636 | 28 | YT-4631 | 6/60 |
| YT-4637 | 35 | YT-4632 | 6/60 |
| YT-4638 | 45 | YT-4633 | 6/60 |
| YT-4639 | 60 | YT-4634 | 6/60 |

- GB Nylon head for mallet
 D Nylon Schlagkopf
 PL Końcówka nylonowa do młotka
 RUS Наконечник молотка из твердого нейлона
 CZ Náhradní koncovka k paličce nylon
 H Műanyag kalapácsfej cserélhető
 RO Cap nylon pt. ciocan tinichigerie
 E Cabeza de nylon para martillo chapista
 CN 尼龙硬头

NYLON

HARD
TWARDA

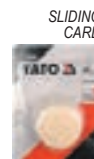

| YATO | Ø (mm) | for / dla | |
|---------|--------|-----------|------|
| YT-4640 | 22 | YT-4630 | 6/60 |
| YT-4641 | 28 | YT-4631 | 6/60 |
| YT-4642 | 35 | YT-4632 | 6/60 |
| YT-4643 | 45 | YT-4633 | 6/60 |
| YT-4644 | 60 | YT-4634 | 6/60 |

- GB Auto body fender set
D Karosserie-Ausbeulsatz
PL Komplet młotków blacharskich
RUS Молотки рихтовочные
CZ Souprava klempířských kladívek
H Bádogos kalapács készlet
RO Set de ciocane de tabla
E Juego de mazos de hojalatero
CN 钣金工具组套

7
PCS



DROP
FORGED
KUTE

GENUINE
HICKORY





BMC
& COLOR
SLEEVE



| YATO  | m (g) |  |
|--|-------|---|
| YT-4590 | 4900 | 4 |



- GB Ball pein hammer
D Ausbeulhammer
PL Młotek blacharski
RUS Молоток рихтовочный
CZ Klempířské kladívko
- H Bádogos kalapács
RO Ciocan pt. tabla
E Martillo de hojalatero
CN 圆头锤



| YATO  | m (g) | L (mm) | A (mm) | H (mm) |  |
|--|-------|--------|--------|--------|---|
| YT-4515 | 225 | 280 | 26 | 80 | 6/36 |
| YT-4516 | 450 | 315 | 34 | 100 | 6/24 |
| YT-4517 | 680 | 370 | 36 | 115 | 6/12 |
| YT-4518 | 900 | 380 | 40 | 125 | 6/12 |

- GB Ball pein hammer
D Ausbeulhammer
PL Młotek blacharski
RUS Молоток рихтовочный
CZ Klempířské kladívko
- H Bádogos kalapács
RO Ciocan pt. tabla
E Martillo de hojalatero
CN 柄圆头锤



| YATO  | m (g) | L (mm) | A (mm) | H (mm) |  |
|--|-------|--------|--------|--------|---|
| YT-4519 | 225 | 295 | 26 | 80 | 6/36 |
| YT-4520 | 450 | 335 | 35 | 100 | 6/24 |
| YT-4521 | 680 | 360 | 36 | 115 | 6/12 |
| YT-4522 | 900 | 380 | 40 | 125 | 6/12 |

GB Wood chisel
D Stechbeitel
PL Dłuto stolarskie
RUS Долото
CZ Rezbářské dláto

H Asztalos véső
RO Daltă de tâmplărie
E Cincel para madera
CN 木工凿

DOUBLE
BLISTER



CrV
60

HRC
56-62



| YATO | size / rozmiar (mm) | |
|---------|---------------------|-------|
| YT-6241 | 8 | 10/60 |
| YT-6242 | 10 | 10/60 |
| YT-6243 | 12 | 10/60 |
| YT-6244 | 14 | 10/60 |
| YT-6245 | 15 | 10/60 |
| YT-6246 | 16 | 10/60 |
| YT-6247 | 18 | 10/60 |

| YATO | size / rozmiar (mm) | |
|---------|---------------------|-------|
| YT-6248 | 20 | 10/60 |
| YT-6249 | 22 | 10/60 |
| YT-6251 | 25 | 10/60 |
| YT-6253 | 28 | 10/60 |
| YT-6256 | 35 | 10/60 |
| YT-6258 | 38 | 10/60 |

GB Chisel set
D Meißelsatz
PL Zestaw dłut

RUS Набор зубил
CZ Sada dlát
H Hidegvágó készlet

RO Set de dălti
E Juego de cinceles
CN 木工凿组套

4
PCS

10 16
20 25
mm

CrV
60

HRC
58-60



DOUBLE
BLISTER



YATO
YT-6260

5/20

GB Chisel set
D Meißelsatz
PL Zestaw dłut
RUS Набор зубил
CZ Sada dlát

H Hidegvágó készlet
RO Set de dălti
E Juego de cinceles
CN 木工凿组套

3
PCS

CrV

16 25
32 mm

PLASTIC
HANGER



YATO
YT-6280

10/30



4
PCS

CrV

10 12
16 20
mm

PLASTIC
HANGER



YATO
YT-6281

6/24

GB Cold chisel with protection
D Schlitzmeißel mit Handschutz
PL Przecinak z osłoną
RUS Зубило с протектором
CZ Plochý sekáč (z krytem)
H Hidegvágó,

RO lapos (védőfejjel)
Daltă - tăietor
plată (cu apărătoare)
E Cincel plano (con protector)
CN 石工凿

25x300
mm

CrV



PLASTIC
HANGER

YATO
YT-4700

L (mm)
300

4/24

GB Cold chisel with protection
D Schlitzmeißel mit Handschutz
PL Przecinak z osłoną
RUS Зубило с протектором
CZ Plochý sekáč (z krytem)

H Hidegvágó, lapos (védőfejjel)
Daltă - tăietor
plată (cu apărătoare)
E Cincel plano (con protector)
CN 石工凿

76x267
mm

CrV



PLASTIC
HANGER

YATO
YT-4701

L (mm)
267

4/24

GB Punch with protection
D Spitzmeißel mit Handschutz
PL Przebijak z osłoną
RUS Скарпель с пластмассовой ручкой
CZ Zednický průbojník (z krytem)
H Falvéső (védőfejjel)
RO Dom (perforator) pt. perete (cu apărătoare)
E Cincel de cerrajería con protector
CN 水泥尖凿

300
mm

CrV



PLASTIC
HANGER

YATO
YT-4705

L (mm)
300

4/24

GB Chisel and punch set
D Trennmeißel-
und Durchtreiber-Satz
PL Zestaw przecinaków i punktaków
RUS Зубила и пробойники
с протектором
CZ Sekáče a průbojníky

H Véső és lyukasztó készlet
RO Set dalti de impact
E Juego de cinceles
de acero templado
y punzones
CN 冲凿组套

6
PCS

CHISEL
12x180 mm
16x180 mm
19x180 mm

PUNCH
3x180 mm
3x180 mm
4x180 mm

CrV



PLASTIC
HANGER



YATO
YT-4710

L (mm)
180

10/20

GB Cold chisel
D Flachmeißel
PL Przecinak płaski
RUS Зубило плоское
CZ Sekáč plochý
H Laposvágó
RO Dalta lata
E Tajadera en frío
CN 凿子



CrV
6150



SLIDING
CARD

| YATO | L (mm) | chisel width / szerokość dłuta (mm) | |
|----------|--------|--|--------|
| YT-47147 | 142 | 10.0 | 20/120 |
| YT-47148 | 152 | 12.5 | 20/120 |
| YT-47149 | 172 | 16.0 | 20/120 |

GB Taper punch
D Durchtreiber
PL Dobijak stożkowy
RUS Пробойник конусный
CZ Průbojník
H Lyukasztó
RO Dorn conic
E Retacador de cono
CN 冲子

150
mm



CrV
6150



SLIDING
CARD

| YATO | L (mm) | pin diameter / średnica grotu (mm) | |
|----------|--------|---------------------------------------|--------|
| YT-47141 | 150 | 1.5 | 20/120 |
| YT-47142 | 150 | 3.0 | 20/120 |
| YT-47143 | 150 | 4.0 | 20/120 |
| YT-47144 | 150 | 5.0 | 20/120 |
| YT-47145 | 150 | 6.0 | 20/120 |
| YT-47146 | 150 | 8.0 | 20/120 |

GB Taper punch
D Durchtreiber
PL Dobijak stożkowy
RUS Пробойник конусный
CZ Průbojník
H Lyukasztó
RO Dorn conic
E Retacador de cono
CN 冲子

SLIDING
CARD



140
mm



CrV
6150



GB Center punch
D Kömer
PL Punktak
RUS Пробойник - керн
CZ Důlčik
H Pontozó
RO Punctor
E Retacador - punzón centrador
CN 冲子

SLIDING
CARD



CrV
6150



| YATO | L (mm) | center punch / średnica punktaka (mm) | |
|----------|--------|--|--------|
| YT-47152 | 140 | 2.0 | 20/120 |

| YATO | L (mm) | taper point end / średnica stożka (mm) | |
|----------|--------|---|--------|
| YT-47150 | 100 | 6.0 | 20/120 |
| YT-47151 | 112 | 8.0 | 20/120 |

GB Pin punch set
D Splintentreiber Satz
PL Zestaw wybijaków
RUS Пробойник булавочный- набор
CZ Sada vyrážečů
H Csapszegkiütő készlet
RO Set de dornuri
E Juego de punzones
CN 销式冲子组套

SLIDING
CARD



6
PCS

150
mm



PIN DIAMETER:
1.5, 3.0, 4.0,
5.0, 6.0,
8.0 mm

CrV
6150



| YATO | L (mm) | |
|----------|--------|------|
| YT-47121 | 150 | 6/24 |

GB Chisel set
D Flachmeißelsatz
PL Zestaw przecinaków
RUS Зубила в наборе
CZ Sekáče
H Hidegvágó
RO Set dalti zidarie
E Cinceles
CN 冲凿组套

PLASTIC
HANGER



3
PCS

CHISEL
10x142 mm
12x152 mm
16x172 mm

CrV



| YATO | |
|---------|------|
| YT-4711 | 6/24 |

GB Chisel and punch set
D Trennmeißel- und Durchtreiber-Satz
PL Zestaw przecinaków i punktaków
RUS Зубила, керны и пробойники в наборе
CZ Sekáče a průbojníky
H Véső és lyukasztó készlet
RO Set dalti de impact
E Juego de cinceles de acero templado y punzones
CN 冲凿组套

PLASTIC
HANGER



6
PCS

CHISEL
10x142
12x152
mm

PUNCH
2x140 mm
3x152 mm
6x152 mm
8x115 mm

CrV



| YATO | |
|---------|------|
| YT-4712 | 6/24 |

GB Mini cold chisel and punch set
 D Trennmeissel- und Durchtreiber-Satz
 PL Zestaw wybijaków i przecinaków
 RUS Зубила и керны в наборе
 CZ Sekáče a průbojníky
 H Véső és lyukasztó készlet
 RO Set dalti de impact
 E Juego de cinceles de acero templado y punzones
 CN 迷你冲凿组套

PLASTIC HANGER



3 PCS 125 mm
 CrV COLD CHISEL: 10 mm
 PIN PUNCH: 3 mm SOLID PUNCH: 3 mm



YATO YT-4713 10/60

GB Chisel and punch set
 D Trennmeissel- und Durchtreiber-Satz
 PL Zestaw przecinaków i punktaków
 RUS Зубила и керны в наборе
 CZ Sekáče a průbojníky
 H Véső és lyukasztó készlet
 RO Set dalti de impact
 E Juego de cinceles de acero templado y punzones
 CN 冲凿组套

12 PCS CrV SOLID PUNCH: 4 mm CENTER PUNCH: 90 DEGR. 6 mm 8 mm
 PIN PUNCH: 1.5 mm 3 mm 4 mm 5 mm 6 mm 8 mm
 COLD CHISEL: 10 mm 13 mm 16 mm

PLASTIC HANGER



YATO YT-4714 10/20

8

GB Pin punch
 D Splintentreiber
 PL Wybijak
 RUS Пробойник булавочный
 CZ Vyrážec
 H Csapszegkiütő
 RO Dorn cilindric
 E Punzón expulsador
 CN 销式冲子

SLIDING CARD



150 mm CrV 60 PIN DIAMETER: ø 3.8 mm



YATO YT-4690 L (mm) 20/120 150

GB Taper punch
 D Durchtreiber
 PL Dobijak stożkowy
 RUS Пробойник конусный
 CZ Průbojník
 H Lyukasztó
 RO Dorn conic
 E Retacador de cono
 CN 冲孔器

SLIDING CARD



120 mm CrV 60 CENTER PUNCH: ø 3.3 mm



YATO YT-4691 L (mm) 20/120 120

GB Center punch
 D Körner
 PL Dobijak punktak
 RUS Пробойник - керн
 CZ Důlčik
 H Pontozó
 RO Punctator
 E Retacador - punzón centrador
 CN 冲子

SLIDING CARD



120 mm CrV 60 TAPER POINT END



YATO YT-4692 L (mm) 20/120 120

GB Cold chisel
 D Flach Meissel
 PL Przecinak płaski
 RUS Зубило плоское
 CZ Sekáč plochý
 H Laposvágó
 RO Dalta lata
 E Tajadera en frío
 CN 扁铲

SLIDING CARD



130 mm CrV 60 CHISEL WIDTH: 12 mm



YATO YT-4693 L (mm) 20/120 130

GB Cape chisel
 D Kreuzmeissel
 PL Przecinak prostokątny
 RUS Зубило „лика”
 CZ Sekáč křížový
 H Keresztvágó
 RO Dalta ascutita
 E Tajadera rectangular
 CN 钎头

SLIDING CARD



130 mm CrV 60 CHISEL WIDTH: 5.5 mm



YATO YT-4694 L (mm) 20/120 130

GB Chisel and punch set
 D Trennmeissel- und Durchtreiber-Satz
 PL Zestaw przecinaków i punktaków
 RUS Зубила и керны в наборе
 CZ Sekáče a průbojníky
 H Véső és lyukasztó készlet
 RO Set dalti de impact
 E Juego de cinceles de acero templado y punzones
 CN 样冲组套

SLIDING CARD



5 PCS CrV 60 PIN PUNCH: ø 3.8 mm TAPER PUNCH: ø 3.3 mm TAPER POINT END COLD CHISEL: 12 mm CAPE CHISEL: 5.5 mm



YATO YT-4695 6/24

GB Hexagonal wrecking bar
D Brechstange
PL Łom sześciokątny
RUS Лом-гвоздодёр шестигранный
CZ Šestiúhľé páčidlo
H Hatszögű feszítővas
RO Ranga pt. scos cuie
E Palanqueta
CN 撬棒

DROP FORGED KUTE



| YATO | size / rozmiar (mm) | |
|----------|---------------------|------|
| YT-46800 | 400x18 | 6/12 |
| YT-46801 | 450x18 | 6/12 |
| YT-46802 | 600x18 | 6/12 |
| YT-46803 | 750x18 | 6/12 |
| YT-46804 | 900x18 | 5/10 |

GB Profiled wrecking bar
D Nageleisen
PL Łom profilowany
RUS Лом-гвоздодёр
CZ Páčidlo
H Szögűhúzó
RO Ranga pt. scos cuie
E Palanqueta
CN 撬棒

DROP FORGED KUTE



| YATO | size / rozmiar (mm) | |
|----------|---------------------|------|
| YT-46810 | 350x22x13 | 6/12 |
| YT-46811 | 450x30x17 | 6/12 |
| YT-46812 | 600x30x17 | 4/8 |
| YT-46813 | 750x30x17 | 4/8 |
| YT-46814 | 900x30x17 | 3/6 |

GB Flat wrecking bar
D Nageleisen spitze
PL Łom płaski
RUS Лом плоский
CZ Páčidlo ploché
H Lapos feszítővas
RO Ranga plata
E Palanqueta
CN 撬棒

DROP FORGED KUTE



| YATO | size / rozmiar (mm) | |
|----------|---------------------|-------|
| YT-46820 | 300x35x6 | 10/30 |
| YT-46821 | 380x35x6 | 10/20 |
| YT-46822 | 450x35x6 | 10/20 |
| YT-46823 | 600x35x6 | 10/20 |

GB Go-through pry bar set
D Nageleisensatz
PL Zestaw łomów

RUS Набор ломов
CZ Sada mini páčidel
H Szögűhúzó készlet

RO Set leviere
E Juego de palancas de hierro
CN 穿心撬棒组套

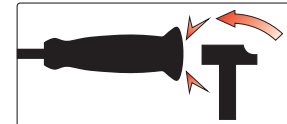

4 PCS

- 198x6x6 mm, 110 g
- 304x10x10 mm, 292 g
- 456x10x10 mm, 479 g
- 608x12x12 mm, 745 g

DOUBLE BLISTER

| YATO | | |
|---------|--|-----|
| YT-4730 | | 3/6 |

GB Axe
D Beil Hicorystiel
PL Siekiera

RUS Топор
CZ Sekerka

H Szekerce
RO Secure

E Hacha
CN 把斧

DIN 5131 7294

GENUINE HICKORY

Timber wedge and steel ring

Genuine hickory shaft



Forged carbon steel head hardened and tempered

| YATO | m (g) | L (mm) | DIN | |
|---------|-------|--------|------|----|
| YT-8001 | 600 | 360 | 5131 | 24 |
| YT-8002 | 800 | 380 | 5131 | 20 |
| YT-8003 | 1000 | 430 | 5131 | 12 |
| YT-8004 | 1250 | 710 | 7294 | 12 |
| YT-8005 | 1400 | 710 | 7294 | 12 |
| YT-8006 | 1600 | 810 | 7294 | 12 |

GB Axe
D Beil Hicorystiel
PL Siekiera

RUS Топор
CZ Sekerka

H Szekerce
RO Secure

E Hacha
CN 把斧

GENUINE HICKORY

Timber wedge and steel ring

Genuine hickory shaft



Forged carbon steel head hardened and tempered

| YATO | m (g) | L (mm) | |
|---------|-------|--------|---|
| YT-8011 | 1000 | 515 | 6 |
| YT-8012 | 2000 | 820 | 6 |

9

Clamps, vices & holders Ściski, imadła i wsporniki



Clamps
Ściski

154



Magnetic holders
Wsporniki magnetyczne

156



Vices
Imadła

155



- GB F-clamp
- D Schraubzwinge
- PL Ścisk stolarski
- RUS Струбцина
- CZ Truhlářské upínadlo
- H Asztalos szorító
- RO Menghină
- pt. tâmplărie
- E Tornillo de apriete
- CN F夹钳



QUICK
ADJUSTMENT
SZYBKA
REGULACJA

| YATO | L (mm) | |
|---------|--------|-------|
| YT-6401 | 160x80 | 10/30 |
| YT-6402 | 200x80 | 10/30 |
| YT-6403 | 250x80 | 10/30 |
| YT-6404 | 300x80 | 10/30 |
| YT-6405 | 450x80 | 10/20 |

| YATO | L (mm) | |
|---------|---------|-------|
| YT-6406 | 600x80 | 10/20 |
| YT-6407 | 400x120 | 10 |
| YT-6408 | 500x120 | 10 |
| YT-6409 | 600x120 | 10 |
| YT-6410 | 900x120 | 5 |



QUICK
ADJUSTMENT
SZYBKA
REGULACJA

| YATO | L (mm) | |
|---------|----------|----|
| YT-6412 | 300x120 | 10 |
| YT-6413 | 400x120 | 10 |
| YT-6414 | 500x120 | 5 |
| YT-6415 | 600x120 | 5 |
| YT-6416 | 900x120 | 5 |
| YT-6417 | 1050x120 | 5 |



| YATO | L (mm) | |
|---------|--------|-------|
| YT-6440 | 100x50 | 12/60 |
| YT-6441 | 150x50 | 12/48 |
| YT-6442 | 200x50 | 12/48 |
| YT-6443 | 250x50 | 12/48 |
| YT-6444 | 300x50 | 12/48 |
| YT-6445 | 200x80 | 10/20 |
| YT-6446 | 250x80 | 10/20 |
| YT-6447 | 300x80 | 10/20 |

| YATO | L (mm) | |
|---------|----------|-------|
| YT-6448 | 500x80 | 10/20 |
| YT-6449 | 300x120 | 10 |
| YT-6450 | 500x120 | 10 |
| YT-6451 | 800x120 | 6 |
| YT-6452 | 1000x120 | 6 |
| YT-6453 | 1200x120 | 6 |
| YT-6454 | 1500x120 | 6 |

9

- GB Quick release clamp
- D Schnellklemme
- PL Ścisk szybkozaciskowy
- RUS Быстрозажимная струбцина
- CZ Svěrka rychloupínací
- H Gyors asztalos szorító

- RO Clemă cu prindere rapidă
- E Apretador rápido
- CN 快速夹



QUICK
ADJUSTMENT
SZYBKA
REGULACJA

| YATO | L (mm) | max. expand range / max. zasięg rozpięcia (mm) | max. clamping range / max. zasięg ściskania (mm) | max. jaws depth / max. głębokość szczęk (mm) | |
|----------|--------|--|--|--|------|
| YT-64280 | 200 | 247-515 | 0-203 | 92 | 6/18 |
| YT-64281 | 300 | 247-616 | 0-304 | 92 | 6/12 |
| YT-64282 | 450 | 247-769 | 0-457 | 92 | 6/12 |
| YT-64283 | 600 | 247-921 | 0-609 | 92 | 6/12 |
| YT-64284 | 750 | 247-1074 | 0-762 | 92 | 4/8 |

| YATO | L (mm) | max. expand range / max. zasięg rozpięcia (mm) | max. clamping range / max. zasięg ściskania (mm) | max. jaws depth / max. głębokość szczęk (mm) | |
|----------|--------|--|--|--|------|
| YT-64290 | 200 | 206-456 | 0-203 | 85 | 6/18 |
| YT-64291 | 300 | 206-557 | 0-304 | 85 | 6/18 |
| YT-64292 | 450 | 206-710 | 0-457 | 85 | 6/12 |
| YT-64293 | 600 | 206-862 | 0-609 | 85 | 6/12 |
| YT-64294 | 750 | 206-1015 | 0-762 | 85 | 6/12 |
| YT-64295 | 900 | 206-1167 | 0-914 | 85 | 6/12 |

- GB Spring clamp
- D Federklemme
- PL Ścisk sprężynowy
- RUS Струбцина
- CZ Pružinové upínadlo
- H Rugós szorító
- RO Cleste presa pt. lemn
- E Pinza
- CN 弹簧夹



| YATO | L (mm) | max. jaws range / max. zasięg szczęk (mm) | max. jaws depth / max. głębokość szczęk (mm) | |
|----------|--------|---|--|--------|
| YT-64270 | 100 | 42 | 44 | 24/240 |
| YT-64271 | 150 | 55 | 68 | 12/120 |
| YT-64272 | 200 | 79 | 91 | 10/100 |

- GB C-Clamp
- D C-Schraubzwinge
- PL Ścisk typu „C”
- RUS Струбцина типа „C”
- CZ Svěrka tvaru „C”
- H Pillanatszorító
- RO Menghină tip „C”
- E Tornillo tipo „C”
- CN 深喉型C型夹



DROP
FORGED
KUTE

| YATO | size / rozmiar (mm) | force pressure / siła nacisku (kg) | |
|---------|---------------------|------------------------------------|------|
| YT-6420 | 50 | 1500 | 6/30 |
| YT-6421 | 75 | 1950 | 6/18 |
| YT-6422 | 100 | 2980 | 6/12 |
| YT-6423 | 150 | 3200 | 6/12 |
| YT-6424 | 200 | 3600 | 6 |

GB Swivel base bench vice
D Drehbare Schraubstock
PL Imadło ślusarskie obrotowe
RUS Тиски слесарные поворотные
CZ Zámečnický svěrák otáčivě
H Satu, lakatos forgó
RO Menghină rotativă
E Tornillo de apriete giratorio
CN 台虎钳

COLOR BOX



- anvil and changeable jaws made of hardened steel
- kowadełko i wymienne szczęki z hartowanej stali

| | | | | |
|--|-------------------|-------------|--------------------------|---|
| | 7 kg | YATO | weight (kg) waga (kg) | |
| | | YT-6501 | 7 | 2 |
| | 10 kg | YATO | weight (kg) waga (kg) | |
| | | YT-6502 | 10 | 2 |
| | 15 kg | YATO | weight (kg) waga (kg) | |
| | | YT-6503 | 15 | 1 |
| | 19 kg | YATO | weight (kg) waga (kg) | |
| | | YT-65048 | 19 | 1 |
| | 21 kg | YATO | weight (kg) waga (kg) | |
| | | YT-6504 | 21 | 1 |
| | 29.5 kg | YATO | weight (kg) waga (kg) | |
| | | YT-65049 | 29.5 | 1 |

GB Hinged pipe vice
D Rohrschraubstock
PL Imadło zaciskowe do rur
RUS Тиски для труб
CZ Upinací svěrák na trubky
H Satu, csőszorító
RO Menghină pt. țevi
E Tornillo de apriete para tubos
CN 管子台虎钳



S55C

COLOR BOX



| YATO | Ø (mm) | |
|---------|--------|---|
| YT-6510 | 60 | 4 |
| YT-6511 | 76 | 2 |
| YT-6512 | 90 | 2 |
| YT-6513 | 110 | 1 |

GB Swivel base bench vice
D Drehbare Schraubstock
PL Imadło ślusarskie obrotowe
RUS Тиски слесарные поворотные
CZ Zámečnický svěrák otáčivě
H Satu, lakatos forgó
RO Menghină rotativă
E Tornillo de apriete giratorio
CN 多功能台虎钳

COLOR BOX



- anvil and changeable jaws made of hardened steel
- kowadełko i wymienne szczęki z hartowanej stali

| | | | | | | | | |
|--|--|--|--|-------------------------------------|-----------------|-------------|--------------------------|---|
| | | | | HRC 45-52 JAWS/SZCZĘKI | 10 kg | YATO | weight (kg) waga (kg) | |
| | | | | | | YT-6505 | 10 | 1 |
| | | | | HRC 45-52 JAWS/SZCZĘKI | 20 kg | YATO | weight (kg) waga (kg) | |
| | | | | | | YT-6506 | 20 | 1 |

- GB Adjustable angle welding magnet
 D Verstellbarer Magnet-Werkstückhalter
 PL Wspornik magnetyczny spawalniczy regulowany
 RUS Регулируемый магнит заварки угла
 CZ Pohovovací magnetický držák ke svařování
 H Állítható, mágneses, hegesztő támasz
 RO Dispozitiv magnetic reglabil pt. sudura
 E Soporte magnético de soldadura, ajustable
 CN 焊接磁铁



DOUBLE BLISTER



| YATO | (kg) | mm | |
|---------|--------|----------|---|
| YT-0862 | 2x22.5 | 85x65x22 | 6 |

- GB Magnetic welding holder
 D Magnet-Werkstückhalter
 PL Kątownik magnetyczny spawalniczy
 RUS Магнитная струбцина заварки
 CZ Magnetický uhelník ke svařování
 H Mágneses, hegesztő szögvas
 RO Dispozitiv magnetic fixare pt. sudura
 E Escuadra magnética de soldadura
 CN 焊接磁铁

DOUBLE BLISTER



| YATO | (kg) | mm | |
|---------|------|------------|------|
| YT-0863 | 11.5 | 82x120x13 | 6/48 |
| YT-0864 | 22.5 | 102x155x17 | 6/30 |
| YT-0865 | 34.0 | 122x190x25 | 6/18 |

- GB Magnetic welding holder
 D Magnet-Werkstückhalter
 PL Kątownik magnetyczny spawalniczy
 RUS Магнитная струбцина заварки
 CZ Magnetický uhelník ke svařování
 H Mágneses, hegesztő szögvas
 RO Dispozitiv magnetic fixare pt. sudura
 E Escuadra magnética de soldadura
 CN 焊接磁铁

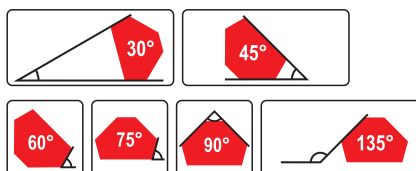

DOUBLE BLISTER



| YATO | (kg) | mm | |
|---------|------|------------|------|
| YT-0866 | 11.5 | 64x95x14 | 6/24 |
| YT-0867 | 34.0 | 111x136x24 | 6/18 |

- GB Magnetic welding holder with switch
 D Magnet-Werkstückhalter mit Schalter
 PL Kątownik magnetyczny spawalniczy z wyłącznikiem
 RUS Магнитный держатель заварки с выключателем
 CZ Magnetický uhelník ke svařování s vypínačem
 H Mágneses, hegesztő szögvas, kapcsolóval
 RO Dispozitiv magnetic fixare pt. sudura cu intreruptor
 E Escuadra magnética de soldadura, con interruptor
 CN 焊接磁铁

DOUBLE BLISTER



| YATO | (kg) | mm | |
|---------|------|------------|------|
| YT-0868 | 13.5 | 85x139x25 | 6/36 |
| YT-0869 | 25.0 | 117x192x32 | 6/18 |
| YT-0870 | 13.5 | 107x160x26 | 6/24 |

Memo

10

Cutting tools Narzędzia tnące

YATO 

item number:
YT-6068

- en TCT circular saw blade for cutting of wood
- de Hartmetallbestückt Kreissägeblatt für schneiden von Holz
- pl Pila tarczowa do drewna z węglkiem wolframu
- ru Пила дисковая по дереву (твердый сплав)

210x30x3.2x2.2HW

60T



10000 obr/min

YATO 

item number:
YT-6068

- en TCT circular saw blade for cutting of wood
- de Hartmetallbestückt Kreissägeblatt für schneiden von Holz
- pl Pila tarczowa do drewna z węglkiem wolframu
- ru Пила дисковая по дереву (твердый сплав)
- ro Ferăstrău circular cu dinți din wolfram pt. Lemn

210x30x3.2x2.2HW

60T 



n_{max} 8 000 obr/min



Drills
Wiertła

161-166



| | |
|--|-----|
| Twist drill bits HSS, HSS-G & sets | |
| Wiertła do metalu HSS, HSS-G i zestawy | 161 |
| Twist drill bits HSS-E Co | |
| Wiertła do metalu HSS-E Co | 162 |
| SDS masonry drill bits X-TIP | |
| Wiertła do betonu SDS, z grotem krzyżowym | 162 |
| SDS masonry drill bits | |
| Wiertła do betonu SDS | 163 |
| Masonry drill bits with cylindrical shank & sets | |
| Wiertła do betonu z uchwytem cylindrycznym i zestawy | 163 |
| Flat wood drill bits & sets | |
| Wiertła łopatkowe do drewna i zestawy | 164 |
| Spur wood drill bits | |
| Wiertła do drewna spiralne | 165 |
| Auger wood drill bits & sets | |
| Świdry do drewna i zestawy | 165 |
| Drills for glass | |
| Wiertła do szkła | 166 |

Adjustable hand reamers
Rozwiertaki nastawne

166



SDS Chisels
Przecinaki i dłuta SDS

166



Hollow drill sets
Wiertła koronowe do betonu

167



Bi-metal hole saws
Otwornice bimetalowe

167-168



| | |
|----------------------------------|-----|
| Bi-metal hole saws | |
| Otwornice bimetalowe | 167 |
| Arbors for hole saws | |
| Uchwyty do otwornic bimetalowych | 167 |
| Hole saw kits | |
| Zestawy otwornic bimetalowych | 168 |

Taps & dies
Narzędzia do gwintowania

169-171



| | |
|--|-----|
| Hand taps & sets | |
| Gwintowniki i zestawy | 169 |
| Circular dies | |
| Narzynki | 170 |
| Tap wrenches & die holders | |
| Pokrętła do gwintowników i narzynek | 170 |
| Thread repair sets & accessories | |
| Zestawy do naprawy gwintów i akcesoria | 171 |

Router bits
Frezy do drewna

172



Diamond tools
Narzędzia diamentowe

173-174



| | |
|--|-----|
| Diamond blades for cutting construction materials | |
| Tarcze diamentowe do cięcia materiałów budowlanych | 173 |
| Diamond blades for cutting concrete | |
| Tarcze diamentowe do cięcia betonu | 173 |
| Diamond blades for cutting stone | |
| Tarcze diamentowe do cięcia kamienia | 173 |
| Diamond blades for cutting ceramic tiles | |
| Tarcze diamentowe do cięcia płytek ceramicznych | 174 |
| Diamond blades for cutting ceramic materials | |
| Tarcze diamentowe do cięcia materiałów ceramicznych | 174 |
| Diamond blades for cutting asphalt | |
| Tarcze diamentowe do cięcia asfaltu | 174 |
| Diamond grinding cup wheels | |
| Diamentowe talerze szlifierskie do betonu i kamienia | 174 |
| Diamond core drill bits | |
| Diamentowe wiertła koronowe | 174 |

Tungsten carbide tipped tools
Narzędzia z ostrzem z węgliku wolframu

175



| | |
|-------------------------------------|-----|
| Tungsten carbide saws for wood | |
| Tarcze z węglikiem do drewna | 175 |
| Tungsten carbide saws for aluminium | |
| Tarcze z węglikiem do aluminium | 175 |

Cutting & grinding discs
Tarcze do cięcia i szlifowania

175-176



| | |
|------------------------------------|-----|
| Stainless steel cutting discs | |
| Tarcze do cięcia stali nierdzewnej | 175 |
| Metal cutting discs | |
| Tarcze do cięcia metalu | 175 |
| Metal grinding discs | |
| Tarcze do szlifowania metalu | 176 |
| Stone cutting discs | |
| Tarcze do cięcia kamienia | 176 |
| Stone grinding discs | |
| Tarcze do szlifowania kamienia | 176 |



Shears
Nożyce

177-181



| | |
|--|-----|
| Heavy duty cable cutters | |
| Nożyce do cięcia przewodów | 177 |
| Tin snips | |
| Nożyce do blachy | 177 |
| Steel strap cutters | |
| Nożyce do cięcia taśm stalowych | 180 |
| Bolt cutters | |
| Nożyce do prętów | 180 |
| Hydraulic cutters & accessories | |
| Nożyce z siłownikiem hydraulicznym i akcesoria | 181 |
| Cable cutters | |
| Nożyce do kabli | 181 |
| Multifunctional scissors | |
| Nożyce wielofunkcyjne | 181 |



| | | | | |
|--------------------------------------|--|---|--|--|
| Saws & blades | |  | Window scrapers | |
| Piły i brzeszczoty | | | Skrobaki do szyb..... 195 | |
| 182-185 | | | Scrapers | |
| Hand saws | | | Cykliny metalowe..... 195 | |
| Piły do drewna..... 182 | | | Steel files & sets | |
| Bow saws | | | Piłniki do metalu i zestawy..... 196 | |
| Piły kabłąkowe..... 182 | | | Needle file sets | |
| Blades | | | Zestawy pilników iglaków..... 197 | |
| Brzeszczoty..... 183 | | | Diamond needle files & sets | |
| Hacksaw frames | | | Piłniki iglaki diamentowe i zestawy..... 197 | |
| Piły do metalu..... 183 | | | Rasps & sets | |
| Hacksaw frame blades | | | Tarniki do drewna i zestawy..... 199 | |
| Brzeszczoty do metalu..... 183 | | | Abrasive products | |
| Jig saw blades | | | Artykuły ścierne | |
| Brzeszczoty do wyrzynarek..... 184 | | | 200-205 | |
| Brushes, knives & files | |  | Sand papers | |
| Szczotki, noże i pilniki | | | Papiery ścierne..... 200 | |
| 185-199 | | | Waterproof sand papers | |
| Wire brushes & sets | | | Papiery ścierne wodoodporne..... 201 | |
| Szczotki druciane i zestawy..... 185 | | | Abrasive clothes | |
| Cup brushes | | | Płótna ścierne..... 202 | |
| Szczotki tarczowe..... 188 | | | No end abrasive bands | |
| Knives & blades | | | Taśmy ścierne bezkońcowe..... 202 | |
| Noże i ostrza..... 189 | | | Flap discs | |
| Scissors | | | Ściernice listkowe..... 203 | |
| Nożyczki..... 192 | | | Abrasive sheets and discs | |
| Profile gauges | | | Arkusze i krążki ścierne..... 205 | |
| Wzorniki profili..... 193 | | | Sanding blocks | |
| Punch sets | | | Bloki ścierne..... 205 | |
| Przebijaki do skóry..... 193 | | | | |
| Cutters | | | | |
| Obcinaki..... 194 | | | | |

GB Twist drill HSS
D Metallspiralbohrer HSS
PL Wiertło do metalu HSS
RUS Сверло по металлу HSS
CZ Vrták na kov HSS

H Fúrószár fémhez HSS
RO Burghiu pt. metal HSS
E Broca para metal HSS
CN 轧制麻花钻

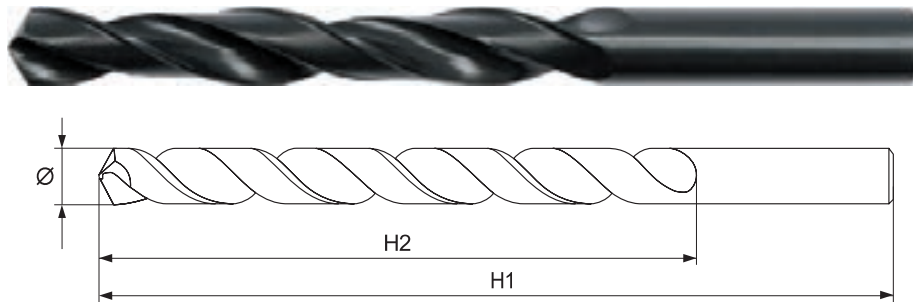
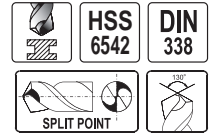

- application: industry
- for precise drilling in steels, cast steels, non-ferrous metals, plastics
- przeznaczenie: przemysł
- do precyzyjnych wierceń w stalach, żeliwach, metalach nieżelaznych, tworzywach sztucznych



| YATO | Ø (mm) | H1 (mm) | H2 (mm) | R.P.M.max. | PCS packing | |
|---------|--------|---------|---------|------------|-------------|--------|
| YT-4430 | 1.0 | 34 | 12 | 3800 | 10 | 80/320 |
| YT-4431 | 1.5 | 43 | 20 | 3800 | 10 | 80/320 |
| YT-4432 | 2.0 | 49 | 24 | 4000 | 10 | 80/320 |
| YT-4433 | 2.5 | 57 | 30 | 3200 | 10 | 80/320 |
| YT-4434 | 2.8 | 61 | 33 | 2800 | 10 | 80/320 |
| YT-4435 | 3.0 | 61 | 33 | 2600 | 10 | 80/320 |
| YT-4436 | 3.2 | 65 | 36 | 2500 | 10 | 80/320 |
| YT-4437 | 3.5 | 70 | 39 | 2300 | 10 | 80/320 |
| YT-4438 | 4.0 | 75 | 43 | 2000 | 10 | 80/320 |
| YT-4439 | 4.2 | 75 | 43 | 1900 | 10 | 20/80 |
| YT-4440 | 4.5 | 80 | 47 | 1800 | 10 | 20/80 |
| YT-4441 | 4.8 | 86 | 52 | 1600 | 10 | 20/80 |
| YT-4442 | 5.0 | 86 | 52 | 1600 | 10 | 20/80 |
| YT-4443 | 5.2 | 86 | 52 | 1500 | 10 | 20/80 |
| YT-4444 | 5.5 | 93 | 57 | 1500 | 10 | 20/80 |

| YATO | Ø (mm) | H1 (mm) | H2 (mm) | R.P.M.max. | PCS packing | |
|---------|--------|---------|---------|------------|-------------|-------|
| YT-4445 | 6.0 | 93 | 57 | 1300 | 10 | 20/80 |
| YT-4446 | 6.5 | 101 | 63 | 1200 | 10 | 10/40 |
| YT-4447 | 7.0 | 109 | 69 | 1100 | 10 | 10/40 |
| YT-4448 | 7.5 | 109 | 69 | 1100 | 10 | 10/40 |
| YT-4449 | 8.0 | 117 | 75 | 1000 | 10 | 10/40 |
| YT-4450 | 8.5 | 117 | 75 | 900 | 5 | 10/40 |
| YT-4451 | 9.0 | 125 | 81 | 900 | 5 | 10/40 |
| YT-4452 | 9.5 | 125 | 81 | 800 | 5 | 10/40 |
| YT-4453 | 10.0 | 133 | 87 | 800 | 5 | 10/40 |
| YT-4454 | 10.5 | 133 | 87 | 800 | 3 | 10/40 |
| YT-4455 | 11.0 | 142 | 94 | 700 | 3 | 10/40 |
| YT-4456 | 12.0 | 151 | 101 | 700 | 3 | 10/40 |
| YT-4457 | 12.5 | 151 | 101 | 600 | 3 | 10/40 |
| YT-4458 | 13.0 | 151 | 101 | 600 | 3 | 10/40 |

GB Twist drill set
D Metallspiralbohrersatz
PL Komplet wiertło do metalu
RUS Набор сверл по металлу
CZ Souprava vrtáků na kov

H Fúrószárkészlet fémhez
RO Set de burghie pt. metal
E Broca para metal
CN 轧制麻花钻组套

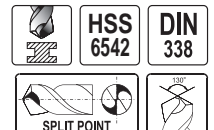

6
PCS

Ø mm
2-8

PLASTIC
HANGING BOX

10
PCS

Ø mm
1-10

PLASTIC
HANGING BOX

19
PCS

Ø mm
1-10

PLASTIC
HANGING BOX

| YATO | Ø (mm) | |
|---------|------------------|-------|
| YT-4460 | 2; 3; 4; 5; 6; 8 | 15/60 |

| YATO | Ø (mm) | |
|---------|-------------------------------|-------|
| YT-4461 | 1; 2; 3; 4; 5; 6; 7; 8; 9; 10 | 20/40 |

| YATO | Ø (mm) | |
|---------|--|-------|
| YT-4462 | 1.0; 1.5; 2.0; 2.5; 3.0; 3.5; 4.0; 4.5; 5.0; 5.5; 6.0; 6.5; 7.0; 7.5; 8.0; 8.5; 9.0; 9.5; 10.0 | 15/30 |

GB Twist drill HSS-G
 D Metallspiralbohrer HSS-G
 PL Wiertło do metalu szlifowane HSS-G
 RUS Сверло по металлу HSS-G
 CZ Vrták na kov HSS-G

H Fúrészár fémhez HSS-G
 RO Burghiu pt. metal HSS-G
 E Broca para metal HSS-G
 CN 全磨制麻花钻

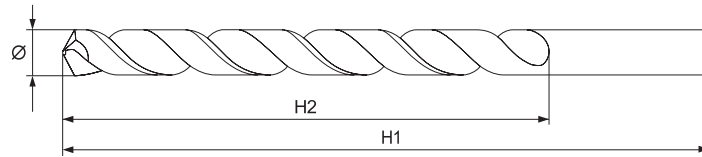

- application: industry
- for precise drilling in steels, cast steels, non-ferrous metals, plastics
- przeznaczenie: przemysł
- do precyzyjnych wierceń w stalach, żeliwach, metalach nieżelaznych, tworzywach sztucznych



BLISTER CARD

| YATO | Ø (mm) | H1 (mm) | H2 (mm) | R.P.M.max. | PCS packing | |
|---------|--------|---------|---------|------------|-------------|--------|
| YT-3903 | 1.5 | 40 | 18 | 4500 | 10 | 80/320 |
| YT-3913 | 2.8 | 61 | 33 | 3000 | 10 | 80/320 |

| YATO | Ø (mm) | PCS packing | |
|---------|--------|-------------|---------|
| YT-3970 | 1.0 | 2 | 120/240 |
| YT-3978 | 3.0 | 2 | 120/240 |
| YT-3980 | 3.5 | 1 | 120/240 |
| YT-3982 | 4.0 | 1 | 120/240 |
| YT-3986 | 5.0 | 1 | 120/240 |

GB Twist drill HSS-COBALT
 D Metallspiralbohrer HSS-COBALT
 PL Wiertło do metalu HSS-COBALT
 RUS Сверло по металлу HSS-COBALT

CZ Vrták na kov HSS-COBALT
 H Fúrészár fémhez HSS-COBALT
 RO Burghiu pt. metal HSS-COBALT
 E Broca para metal HSS-COBALT
 CN 全磨制含钴麻花钻

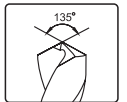
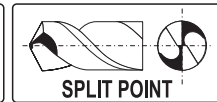

- application: industry
- for precise drilling in hard steels, non-ferrous metals, plastics, stainless steel and acid resistant steel
- resistant to high temperatures
- przeznaczenie: przemysł
- do precyzyjnych wierceń w trudnych materiałach, np. stalach szlachetnych, metalach kolorowych, tworzywach, stalach nierdzewnych i kwasoodpornych
- odporne na działanie wysokiej temperatury

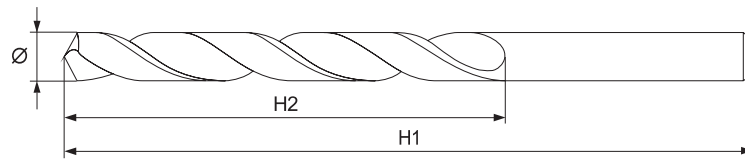

BLISTER CARD

| YATO | Ø (mm) | H1 (mm) | H2 (mm) | PCS packing | |
|---------|--------|---------|---------|-------------|---------|
| YT-4020 | 2.0 | 49 | 24 | 2 | 125/500 |
| YT-4025 | 2.5 | 57 | 30 | 2 | 125/500 |
| YT-4030 | 3.0 | 61 | 33 | 2 | 125/500 |
| YT-4032 | 3.2 | 65 | 36 | 1 | 100/400 |
| YT-4035 | 3.5 | 70 | 39 | 1 | 100/400 |
| YT-4040 | 4.0 | 75 | 43 | 1 | 100/400 |
| YT-4042 | 4.2 | 75 | 43 | 1 | 100/400 |
| YT-4045 | 4.5 | 80 | 47 | 1 | 100/400 |

| YATO | Ø (mm) | H1 (mm) | H2 (mm) | PCS packing | |
|---------|--------|---------|---------|-------------|---------|
| YT-4048 | 4.8 | 86 | 52 | 1 | 100/400 |
| YT-4050 | 5.0 | 86 | 52 | 1 | 100/400 |
| YT-4052 | 5.2 | 86 | 52 | 1 | 100/400 |
| YT-4055 | 5.5 | 93 | 57 | 1 | 100/400 |
| YT-4060 | 6.0 | 93 | 57 | 1 | 100/400 |
| YT-4065 | 6.5 | 101 | 63 | 1 | 75/300 |
| YT-4070 | 7.0 | 109 | 69 | 1 | 75/300 |
| YT-4075 | 7.5 | 109 | 69 | 1 | 75/300 |

| YATO | Ø (mm) | H1 (mm) | H2 (mm) | PCS packing | |
|---------|--------|---------|---------|-------------|--------|
| YT-4080 | 8.0 | 117 | 75 | 1 | 75/300 |
| YT-4085 | 8.5 | 117 | 75 | 1 | 75/300 |
| YT-4090 | 9.0 | 125 | 81 | 1 | 75/300 |
| YT-4100 | 10.0 | 133 | 87 | 1 | 75/300 |
| YT-4110 | 11.0 | 142 | 94 | 1 | 75/300 |
| YT-4120 | 12.0 | 151 | 101 | 1 | 75/300 |
| YT-4140 | 14.0 | 160 | 108 | 1 | 25/100 |
| YT-4160 | 16.0 | 178 | 120 | 1 | 25/100 |

GB Masonry drill bit X-TIP
 D Betonspiralbohrer X-TIP
 PL Wiertło do betonu X-TIP

RUS Сверло по бетону X-TIP
 CZ Vrták na beton X-TIP
 H Fúrészár betonhoz X-TIP

RO Burghiu pt. beton X-TIP
 E Broca para hormigón X-TIP
 CN 十字头电锤钻

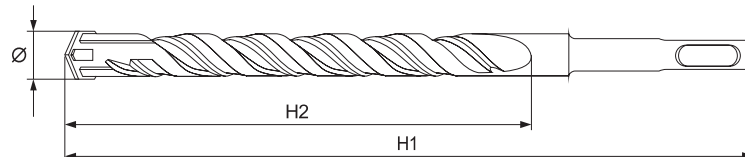

| YATO | Ø (mm) | H1 (mm) | H2 (mm) | PCS packing | |
|---------|--------|---------|---------|-------------|-----|
| YT-4200 | 5 | 110 | 45 | 10 | 300 |
| YT-4201 | 6 | 110 | 45 | 10 | 300 |
| YT-4202 | 6 | 160 | 95 | 10 | 200 |
| YT-4203 | 6 | 210 | 135 | 10 | 150 |
| YT-4204 | 8 | 110 | 45 | 10 | 300 |
| YT-4205 | 8 | 160 | 95 | 10 | 200 |
| YT-4206 | 8 | 210 | 140 | 10 | 150 |
| YT-4207 | 8 | 460 | 370 | 10 | 50 |
| YT-4208 | 8 | 600 | 500 | 10 | 50 |
| YT-4209 | 10 | 160 | 95 | 10 | 150 |
| YT-4210 | 10 | 210 | 140 | 10 | 150 |

| YATO | Ø (mm) | H1 (mm) | H2 (mm) | PCS packing | |
|---------|--------|---------|---------|-------------|-----|
| YT-4211 | 10 | 300 | 220 | 10 | 100 |
| YT-4212 | 10 | 460 | 370 | 10 | 50 |
| YT-4213 | 10 | 600 | 500 | 10 | 50 |
| YT-4214 | 12 | 160 | 95 | 10 | 150 |
| YT-4215 | 12 | 260 | 185 | 10 | 100 |
| YT-4216 | 12 | 460 | 360 | 10 | 50 |
| YT-4217 | 12 | 600 | 490 | 10 | 40 |
| YT-4218 | 14 | 260 | 180 | 10 | 80 |
| YT-4219 | 14 | 460 | 360 | 10 | 40 |
| YT-4220 | 16 | 200 | 125 | 10 | 60 |
| YT-4221 | 16 | 460 | 360 | 10 | 20 |

| YATO | Ø (mm) | H1 (mm) | H2 (mm) | PCS packing | |
|---------|--------|---------|---------|-------------|----|
| YT-4222 | 16 | 600 | 490 | 10 | 20 |
| YT-4223 | 18 | 460 | 360 | 10 | 20 |
| YT-4224 | 18 | 600 | 490 | 10 | 20 |
| YT-4225 | 20 | 460 | 360 | 5 | 20 |
| YT-4226 | 20 | 600 | 490 | 5 | 20 |
| YT-4227 | 22 | 460 | 360 | 5 | 20 |
| YT-4228 | 22 | 600 | 490 | 5 | 20 |
| YT-4229 | 25 | 460 | 360 | 5 | 20 |
| YT-4230 | 25 | 600 | 490 | 5 | 10 |

PLASTIC TUBE & PLASTIC HANGER

GB Masonry drill bit
D Betonspiralbohrer
PL Wiertło do betonu

RUS Сверло по бетону
CZ Vrták na beton
H Fúrószár betonhoz

RO Burghiu pt. beton
E Broca para hormigón
CN 建工钻



SDS PLUS

3 POINT
TIP DK-30

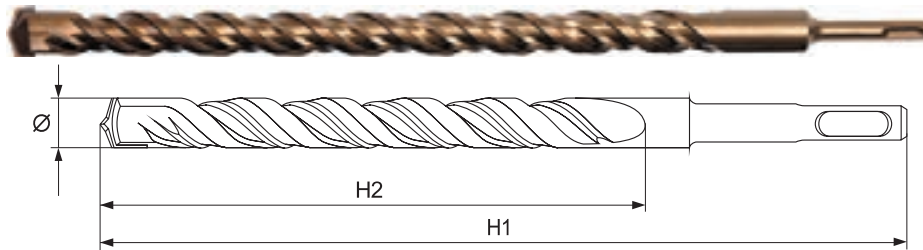

PLASTIC TUBE
& PLASTIC HANGER

| YATO | Ø (mm) | H1 (mm) | H2 (mm) | PCS packing: | |
|---------|--------|---------|---------|--------------|-----|
| YT-4161 | 5 | 110 | 45 | 10 | 300 |
| YT-4162 | 6 | 110 | 45 | 10 | 300 |
| YT-4163 | 6 | 160 | 95 | 10 | 200 |
| YT-4164 | 6 | 210 | 140 | 10 | 150 |
| YT-4165 | 8 | 110 | 45 | 10 | 300 |
| YT-4166 | 8 | 160 | 90 | 10 | 200 |
| YT-4167 | 8 | 210 | 140 | 10 | 150 |
| YT-4168 | 8 | 460 | 370 | 10 | 50 |
| YT-4169 | 8 | 600 | 500 | 10 | 50 |
| YT-4170 | 10 | 160 | 95 | 10 | 150 |
| YT-4171 | 10 | 210 | 140 | 10 | 150 |

| YATO | Ø (mm) | H1 (mm) | H2 (mm) | PCS packing: | |
|---------|--------|---------|---------|--------------|-----|
| YT-4172 | 10 | 300 | 220 | 10 | 100 |
| YT-4173 | 10 | 460 | 370 | 10 | 50 |
| YT-4174 | 10 | 600 | 500 | 10 | 50 |
| YT-4175 | 12 | 160 | 85 | 10 | 150 |
| YT-4176 | 12 | 260 | 180 | 10 | 100 |
| YT-4177 | 12 | 460 | 360 | 10 | 50 |
| YT-4178 | 12 | 600 | 490 | 10 | 40 |
| YT-4179 | 14 | 260 | 190 | 10 | 80 |
| YT-4180 | 14 | 460 | 360 | 10 | 40 |
| YT-4181 | 16 | 200 | 125 | 10 | 60 |
| YT-4182 | 16 | 300 | 220 | 10 | 50 |

| YATO | Ø (mm) | H1 (mm) | H2 (mm) | PCS packing: | |
|---------|--------|---------|---------|--------------|----|
| YT-4183 | 16 | 460 | 360 | 10 | 20 |
| YT-4184 | 16 | 600 | 490 | 10 | 20 |
| YT-4185 | 18 | 460 | 360 | 10 | 20 |
| YT-4186 | 18 | 600 | 490 | 10 | 20 |
| YT-4187 | 20 | 460 | 360 | 5 | 20 |
| YT-4188 | 20 | 600 | 490 | 5 | 20 |
| YT-4189 | 22 | 460 | 360 | 5 | 20 |
| YT-4190 | 22 | 600 | 490 | 5 | 20 |
| YT-4191 | 25 | 460 | 360 | 5 | 20 |
| YT-4192 | 25 | 600 | 490 | 5 | 10 |

GB Masonry drill bit
D Betonspiralbohrer
PL Wiertło do betonu
RUS Сверло по бетону
CZ Vrták na beton

H Fúrószár betonhoz
RO Burghiu pt. beton
E Broca para hormigón
CN 建工钻



YG-8C
HRC 89-90



40CR
HRC 47

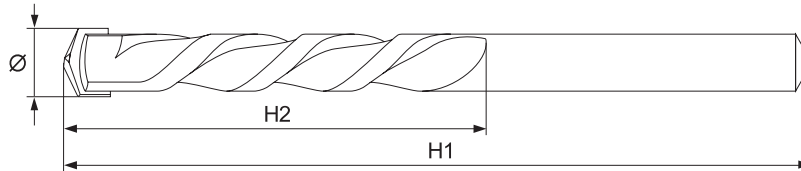

BLISTER
CARD

| YATO | Ø (mm) | H1 (mm) | H2 (mm) | |
|---------|--------|---------|---------|---------|
| YT-4361 | 4 | 70 | 35 | 100/400 |
| YT-4362 | 5 | 90 | 50 | 100/400 |
| YT-4363 | 6 | 100 | 60 | 100/400 |
| YT-4364 | 6 | 150 | 100 | 100/400 |
| YT-4367 | 7 | 100 | 60 | 75/300 |
| YT-4369 | 8 | 120 | 80 | 75/300 |
| YT-4370 | 8 | 200 | 140 | 50/150 |

| YATO | Ø (mm) | H1 (mm) | H2 (mm) | |
|---------|--------|---------|---------|--------|
| YT-4373 | 9 | 120 | 80 | 75/300 |
| YT-4375 | 10 | 120 | 80 | 75/300 |
| YT-4376 | 10 | 200 | 140 | 50/150 |
| YT-4379 | 12 | 150 | 100 | 50/150 |
| YT-4380 | 12 | 200 | 140 | 50/150 |
| YT-4383 | 14 | 180 | 120 | 25/100 |
| YT-4385 | 16 | 180 | 120 | 25/100 |

GB Masonry drill bit set
D Betonspiralbohrersatz
PL Komplet wiertło do betonu
RUS Сверла по бетону в наборе
CZ Souprava vrtáků do betonu
H Fúrószárkészlet betonhoz
RO Set de burghie pt. beton
E Brocas para hormigón
CN 建工钻组套



7
PCS



YG-8C
HRC 89-90



40CR
HRC 47

PLASTIC
HANGING BOX

| YATO | Ø (mm) | |
|---------|-----------------------|-------|
| YT-4390 | 4; 5; 6; 8; 9; 10; 12 | 10/80 |

GB Flat wood drill bit
D Schaufelbohrer
PL Wiertło łopatkowe do drewna

RUS Перовые сверло
CZ Plochy vrták
H Homlokmarós fúró

RO Burghiu plate
E Broca de aletas
CN 木工扁钻

DOUBLE BLISTER



1/4" (6.3mm)

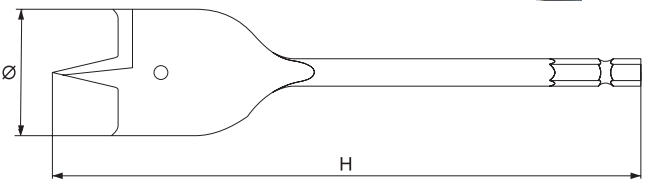

| YATO | Ø (mm) | H (mm) | |
|---------|--------|--------|--------|
| YT-3236 | 6 | 152 | 50/400 |
| YT-3237 | 8 | 152 | 50/400 |
| YT-3238 | 10 | 152 | 50/300 |
| YT-3239 | 12 | 152 | 50/300 |
| YT-3240 | 13 | 152 | 50/300 |
| YT-3241 | 14 | 152 | 50/300 |
| YT-3242 | 16 | 152 | 50/300 |
| YT-3243 | 18 | 152 | 50/300 |
| YT-3244 | 20 | 152 | 50/300 |
| YT-3245 | 22 | 152 | 50/300 |

| YATO | Ø (mm) | H (mm) | |
|---------|--------|--------|--------|
| YT-3246 | 24 | 152 | 50/300 |
| YT-3247 | 25 | 152 | 50/300 |
| YT-3248 | 26 | 152 | 50/300 |
| YT-3249 | 28 | 152 | 50/300 |
| YT-3250 | 30 | 152 | 50/200 |
| YT-3251 | 32 | 152 | 50/200 |
| YT-3252 | 34 | 152 | 50/200 |
| YT-3253 | 35 | 152 | 50/200 |
| YT-3254 | 38 | 152 | 50/200 |
| YT-3255 | 40 | 152 | 50/200 |

GB Extension for flat wood drill bits
D Verlängerung für Schaufelbohrer
PL Przedłużka do wiertel łopatkowych
RUS Удлинитель для перовых сверл
CZ Nástavec pro ploché vrtáky
H Hosszabbító homlokmarós fafúrókhoz
RO Prelungitor pt. burghie plate
E Extensión para brocas de aletas
CN 木工扁钻延长杆

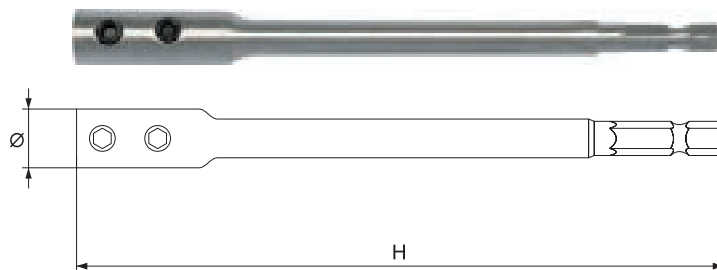

1/4" (6.3mm)

DOUBLE BLISTER

| YATO | Ø (mm) | H (mm) | |
|---------|--------|--------|--------|
| YT-3256 | 12.2 | 150 | 60/120 |
| YT-3257 | 13.5 | 300 | 30/60 |

GB Flat wood drill bit set
D Schaufelbohrersatz
PL Zestaw wiertel łopatkowych
RUS Набор перовых сверл
CZ Sada plochých vrtáků

H Homlokmarós fafúró készlet
RO Set burghie plate
E Juego de brocas de aletas
CN 木工扁钻组套

6 PCS

1/4" (6.3mm)

GB Flat wood drill bit set
D Schaufelbohrersatz
PL Zestaw wiertel łopatkowych
RUS Набор перовых сверл
CZ Sada plochých vrtáků

H Homlokmarós fafúró készlet
RO Set burghie plate
E Juego de brocas de aletas
CN 木工扁钻组套

8 PCS

1/4" (6.3mm)



POUCH

| YATO | Ø (mm) | H (mm) | |
|---------|------------------------|--------|-------|
| YT-3258 | 10; 12; 16; 18; 20; 25 | 152 | 25/50 |



PLASTIC CASE & DOUBLE BLISTER

| YATO | Ø (mm) | H (mm) | |
|---------|--------------------------------|--------|------|
| YT-3259 | 12; 16; 18; 20; 22; 25; 28; 32 | 152 | 5/20 |

GB Spur wood drill bit
D Spiralbohrer für Holz
PL Wiertło do drewna spiralne

RUS Спиральное сверло по дереву
CZ Vrták do dřeva spirálový
H Csigaűró fához

RO Burghiu spirală pt. lemn
E Barrena para madera espiral
CN 木工钻

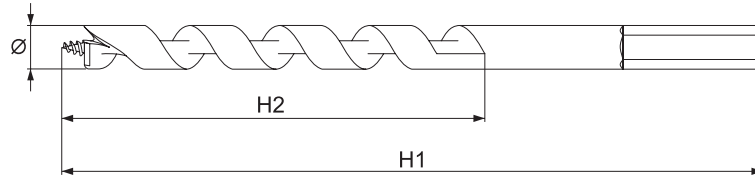

DOUBLE
BLISTER

| YATO | Ø (mm) | H1 (mm) | H2 (mm) | |
|---------|--------|---------|---------|--------|
| YT-4350 | 3 | 60 | 35 | 30/300 |
| YT-4351 | 4 | 75 | 44 | 30/300 |
| YT-4352 | 5 | 85 | 52 | 30/300 |
| YT-4353 | 6 | 90 | 57 | 30/300 |
| YT-4354 | 7 | 100 | 67 | 30/300 |

| YATO | Ø (mm) | H1 (mm) | H2 (mm) | |
|---------|--------|---------|---------|--------|
| YT-4355 | 8 | 110 | 75 | 30/300 |
| YT-4356 | 10 | 120 | 77 | 30/300 |
| YT-4357 | 12 | 150 | 97 | 15/120 |
| YT-4358 | 13 | 150 | 102 | 15/120 |
| YT-4359 | 16 | 180 | 120 | 15/120 |

GB Auger wood drill bit
D Holzbohrer
PL Świder do drewna

RUS Бур по дереву
CZ Vrták do dřeva hadovitý
H Fafúró

RO Burghiu elicoidal pt. lemn
E Barrena para madera
CN 螺旋木工钻

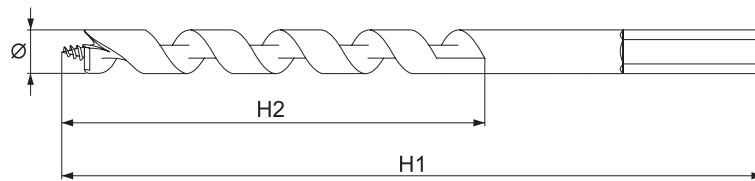

DOUBLE
BLISTER

| YATO | Ø (mm) | H1 (mm) | H1 (mm) | |
|---------|--------|---------|---------|--------|
| YT-3261 | 6 | 191 | 121 | 60/360 |
| YT-3262 | 8 | 191 | 121 | 70/280 |
| YT-3263 | 8 | 400 | 310 | 60/120 |
| YT-3264 | 10 | 191 | 121 | 50/200 |
| YT-3265 | 10 | 400 | 310 | 50/100 |
| YT-3266 | 12 | 191 | 121 | 50/150 |
| YT-3267 | 12 | 400 | 310 | 20/60 |
| YT-3268 | 13 | 191 | 121 | 50/100 |
| YT-3269 | 13 | 400 | 310 | 20/60 |
| YT-3270 | 14 | 191 | 121 | 50/100 |
| YT-3271 | 14 | 400 | 310 | 20/60 |
| YT-3272 | 16 | 191 | 121 | 50/100 |
| YT-3273 | 16 | 400 | 310 | 20/40 |

| YATO | Ø (mm) | H1 (mm) | H1 (mm) | |
|---------|--------|---------|---------|-------|
| YT-3274 | 18 | 215 | 142 | 40/80 |
| YT-3275 | 18 | 400 | 310 | 20/40 |
| YT-3276 | 20 | 215 | 145 | 20/60 |
| YT-3277 | 20 | 400 | 310 | 20/40 |
| YT-3278 | 22 | 215 | 145 | 20/60 |
| YT-3279 | 22 | 400 | 310 | 10/30 |
| YT-3280 | 24 | 215 | 145 | 20/60 |
| YT-3281 | 24 | 400 | 310 | 6/30 |
| YT-3282 | 25 | 215 | 145 | 20/40 |
| YT-3283 | 25 | 400 | 310 | 5/25 |
| YT-3284 | 26 | 215 | 145 | 10/40 |
| YT-3285 | 26 | 400 | 310 | 10/20 |
| YT-3286 | 28 | 240 | 145 | 9/36 |

| YATO | Ø (mm) | H1 (mm) | H1 (mm) | |
|---------|--------|---------|---------|-------|
| YT-3287 | 28 | 400 | 310 | 5/20 |
| YT-3288 | 30 | 240 | 170 | 10/30 |
| YT-3289 | 30 | 400 | 310 | 5/10 |
| YT-3290 | 32 | 240 | 170 | 5/25 |
| YT-3291 | 32 | 400 | 310 | 5/15 |
| YT-3292 | 35 | 240 | 170 | 5/20 |
| YT-3293 | 35 | 400 | 310 | 5/10 |
| YT-3294 | 36 | 240 | 170 | 10/20 |
| YT-3295 | 36 | 400 | 310 | 5/10 |
| YT-3296 | 38 | 240 | 170 | 5/15 |
| YT-3297 | 40 | 240 | 170 | 5/15 |

GB Auger wood drill bit set
D Holzbohrersatz
PL Zestaw świderów do drewna
RUS Набор буров по дереву
CZ Sada hadovitých vrtáků do dřeva
H Fafúró készlet
RO Set de burghie elicoidale pt. lemn
E Juego de barrenas para madera
CN 螺旋木工钻组套



WOOD CASE
& COLOR BOX

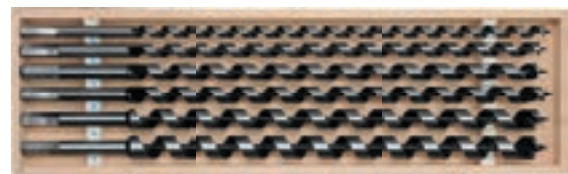

| 6 PCS | 13mm | YATO | Ø (mm) | H (mm) | |
|-------|------|---------|------------------------|--------|---|
| | | YT-3299 | 10; 12; 14; 16; 18; 20 | 460 | 8 |

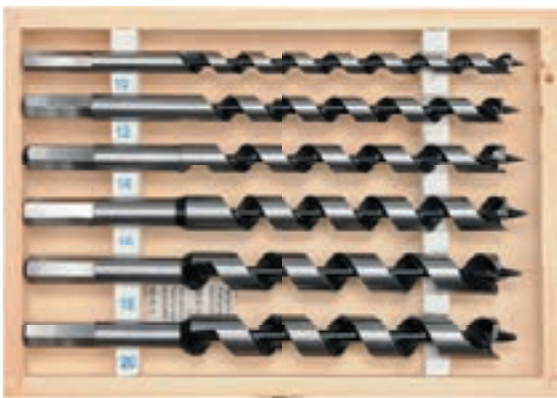

| 6 PCS | 13mm | YATO | Ø (mm) | H (mm) | |
|-------|------|---------|------------------------|--------|----|
| | | YT-3298 | 10; 12; 14; 16; 18; 20 | 230 | 15 |

| 6 PCS | SDS PLUS | YATO | Ø (mm) | H (mm) | |
|-------|----------|---------|------------------------|--------|----|
| | | YT-3300 | 10; 12; 14; 16; 18; 20 | 200 | 20 |

GB Drill for glass
 D Bohrer für Glas
 PL Wiertło do szkła
 RUS Сверло по стеклу
 CZ Vrták do skla
 H Üvegfúró
 RO Burghiu pt. sticlă
 E Broca para vidrio
 CN 玻璃钻



YG6X
 HRA
 90

SLIDING
 CARD

| YATO | Ø (mm) | Box |
|---------|--------|---------|
| YT-3725 | 4 | 100/400 |
| YT-3726 | 6 | 100/400 |

| YATO | Ø (mm) | Box |
|---------|--------|---------|
| YT-3727 | 8 | 100/400 |
| YT-3728 | 10 | 50/200 |

GB Adjustable hand reamer
 D Verstellbare Reibahle
 PL Rozwiertak nastawny
 RUS Регулируемая развертка
 CZ Nastavitelný výstružník
 H Állítható dörzsár
 RO Alezor reglabil
 E Escariador ajustable
 CN 可调式手用铰刀



HSS
 4241

PLASTIC
 TUBE

| YATO | working diameter / średnica robocza (mm²) | L (mm) | arbor diameter / średnica trzpienia (mm²) | Box |
|----------|--|--------|--|--------|
| YT-28950 | 7.75-8.5 | 107 | 4.5 | 50/200 |
| YT-28951 | 8.5-9.25 | 112 | 4.5 | 50/200 |
| YT-28952 | 9.25-10 | 116 | 5.0 | 50/200 |
| YT-28953 | 10-10.75 | 125 | 5.5 | 50/200 |
| YT-28954 | 10.75-11.75 | 130 | 6.5 | 50/200 |
| YT-28955 | 11.75-12.75 | 135 | 7.5 | 50/150 |
| YT-28956 | 12.75-13.75 | 140 | 7.5 | 50/150 |
| YT-28957 | 13.75-15.25 | 158 | 8.0 | 20/60 |
| YT-28958 | 15.25-17 | 165 | 9.0 | 20/60 |

| YATO | working diameter / średnica robocza (mm²) | L (mm) | arbor diameter / średnica trzpienia (mm²) | Box |
|----------|--|--------|--|-------|
| YT-28959 | 17-19 | 175 | 10.0 | 20/60 |
| YT-28960 | 19-21 | 180 | 11.5 | 20/60 |
| YT-28961 | 21-23 | 193 | 13.5 | 20/40 |
| YT-28962 | 23-26 | 210 | 15.4 | 4/20 |
| YT-28963 | 26-29.5 | 245 | 17.0 | 4/20 |
| YT-28964 | 29.5-33.5 | 270 | 19.0 | 4/12 |
| YT-28965 | 33.5-38 | 310 | 21.0 | 2/10 |
| YT-28966 | 38-44 | 345 | 24.0 | 2/10 |
| YT-28967 | 44-54 | 400 | 30.0 | 5 |

GB Point chisel SDS+
 D Spitzmeißel SDS+
 PL Przecinak SDS+
 RUS Зубило SDS+
 CZ Sekáč špičák SDS+
 H Hegyes véső SDS+
 RO Punctator SDS+
 E Cincel puntiagudo SDS+
 CN SDS尖凿

4x14
 x250
 mm
 SDS
 PLUS
 CrV



PLASTIC
 HANGER



| YATO | L (mm) | Box |
|---------|--------|------|
| YT-4720 | 250 | 6/48 |

GB Flat chisel SDS+
 D Flachmeißel SDS+
 PL Dłuto wąskie SDS+
 RUS Долото узкое SDS+
 CZ Sekáč plochý SDS+
 H Lapos véső SDS+
 RO Punctator pt. adancit SDS+
 E Cincel plano estrecho SDS+
 CN SDS平凿

20x14
 x250
 mm
 SDS
 PLUS
 CrV



PLASTIC
 HANGER



| YATO | L (mm) | Box |
|---------|--------|------|
| YT-4721 | 250 | 6/48 |

GB Hollow chisel SDS+
 D Nutenmeißel SDS+
 PL Bruzdownik SDS+
 RUS Бороздник SDS+
 CZ Sekáč drážkovací SDS+
 H Horonyvéső SDS+
 RO Punctator pt. adancit SDS+
 E Cincel acanalado SDS+
 CN SDS空心凿

22x18
 x250
 mm
 SDS
 PLUS
 CrV



PLASTIC
 HANGER



| YATO | L (mm) | Box |
|---------|--------|------|
| YT-4722 | 250 | 6/48 |

GB Flat chisel SDS+
 D Spatmeißel SDS+
 PL Dłuto płaskie SDS+
 RUS Долото плоское SDS+
 CZ Sekáč plochý SDS+
 H Széles lapos véső SDS+
 RO Punctator tip dalta SDS+
 E Cincel plano SDS+
 CN SDS平凿

40x14
 x250
 mm
 SDS
 PLUS
 CrV



PLASTIC
 HANGER



| YATO | L (mm) | Box |
|---------|--------|------|
| YT-4723 | 250 | 6/48 |

GB Hollow drill set
D Bohrkronen
PL Wiertła koronowe do betonu
RUS Сверла по бетону корончатые
CZ Korunový vrták na zeď

H Koronafúró falhoz
RO Burghiu cu coroață pt. beton
E Broca widia para muro
CN 扩孔钻

COLOR BOX



HEX
12mm

SDS
PLUS

| YATO | Ø (mm) | TCT | |
|---------|--------|-----|----|
| YT-4400 | 65 | 6 | 24 |
| YT-4401 | 80 | 8 | 20 |

| YATO | Ø (mm) | TCT | |
|---------|--------|-----|----|
| YT-4402 | 65 | 6 | 24 |
| YT-4403 | 80 | 8 | 20 |

GB Bi-metal hole saw
D Bimetall-Lochsäge
PL Otwornica bimetalowa
RUS Ножовка к отверстиям би-металлическая
CZ Vrtací korunka bimetalová
H Bi-metál koronafúró
RO Găurător bi-metalici
E Sierra de marquetería bi-metálica
CN 双金属孔锯

- application: industry
- to drill holes in stainless steels, cast steels, aluminium, wood, plastics
- cutting depth: 40 mm
- przeznaczenie: przemysł
- do wycinania otworów w stalach nierdzewnych, żelazie, aluminium, drewnie, tworzywach sztucznych
- głębokość cięcia: 40 mm

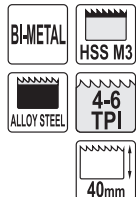

| YATO | Ø (mm) | thread / gwint | |
|---------|--------|----------------|--------|
| YT-3303 | 19 | 1/2" (12.5 mm) | 25/100 |
| YT-3304 | 20 | 1/2" (12.5 mm) | 25/100 |
| YT-3306 | 22 | 1/2" (12.5 mm) | 25/100 |
| YT-3308 | 25 | 1/2" (12.5 mm) | 25/100 |
| YT-3311 | 29 | 1/2" (12.5 mm) | 25/100 |
| YT-3313 | 32 | 5/8" (16 mm) | 25/100 |
| YT-3315 | 35 | 5/8" (16 mm) | 25/100 |
| YT-3317 | 38 | 5/8" (16 mm) | 25/100 |
| YT-3318 | 40 | 5/8" (16 mm) | 25/100 |
| YT-3321 | 44 | 5/8" (16 mm) | 25/100 |

| YATO | Ø (mm) | thread / gwint | |
|---------|--------|----------------|--------|
| YT-3322 | 46 | 5/8" (16 mm) | 25/100 |
| YT-3323 | 48 | 5/8" (16 mm) | 25/100 |
| YT-3324 | 51 | 5/8" (16 mm) | 25/100 |
| YT-3327 | 57 | 5/8" (16 mm) | 25/50 |
| YT-3329 | 60 | 5/8" (16 mm) | 25/50 |
| YT-3330 | 64 | 5/8" (16 mm) | 25/50 |
| YT-3332 | 67 | 5/8" (16 mm) | 25/50 |
| YT-3333 | 68 | 5/8" (16 mm) | 25/50 |
| YT-3334 | 70 | 5/8" (16 mm) | 25/50 |
| YT-3336 | 76 | 5/8" (16 mm) | 25/50 |

| YATO | Ø (mm) | thread / gwint | |
|---------|--------|----------------|-------|
| YT-3338 | 83 | 5/8" (16 mm) | 25/50 |
| YT-3343 | 95 | 5/8" (16 mm) | 25/50 |
| YT-3345 | 102 | 5/8" (16 mm) | 10/20 |
| YT-3346 | 105 | 5/8" (16 mm) | 10/20 |
| YT-3349 | 114 | 5/8" (16 mm) | 10/20 |
| YT-3350 | 121 | 5/8" (16 mm) | 10/20 |
| YT-3351 | 127 | 5/8" (16 mm) | 10/20 |
| YT-3353 | 140 | 5/8" (16 mm) | 10/20 |

GB Arbor for hole saw
D Halterung für Lochsägen
PL Uchwyt do otwornicy
RUS Рукоятка к ножовке

CZ Šroubový unášec pro vrtací korunky
H Befögészár a koronafúróhoz
RO Dispozitiv de antrenare pt. găurător bi-metalici

E Mango para las sierras de marquetería
CN 孔锯柄轴

HEX
SDS
PLUS



DOUBLE
BLISTER



DOUBLE
BLISTER

| YATO | SDS+ / HEX | |
|---------|-------------------|--------|
| YT-3370 | HEX 7/16" (11 mm) | 25/100 |
| YT-3373 | SDS+ | 25/100 |

| YATO | SDS+ / HEX | |
|---------|-------------------|--------|
| YT-3371 | HEX 7/16" (11 mm) | 25/100 |
| YT-3372 | HEX 7/16" (11 mm) | 25/50 |
| YT-3374 | SDS+ | 25/50 |

GB Pilot drill
D Pilotbohrer
PL Wiertło pilot

RUS Сверло пилот
CZ Sřředící vrták
H Központfúró

RO Burghiu pilot
E Broca piloto
CN 导向钻

HSS



| YATO | Ø (mm) | H (mm) | |
|---------|--------|--------|--------|
| YT-3376 | 6.0 | 75 | 25/100 |

| YATO | Ø (mm) | H (mm) | |
|---------|--------|--------|--------|
| YT-3377 | 6.0 | 100 | 25/100 |

- GB Electrician's hole saw kit
- D Lochsägensatz für Elektriker
- PL Zestaw otwornic dla elektryków
- RUS Набор ножовок к отверстиям для электриков
- CZ Sada vrtacích korunek pro elektrikáře
- H Koronafúró készlet villanszerelőknek
- RO Set de găuritori pt. electricieni
- E Juego de sierras de marquetería para electricistas
- CN 双金属开孔器组套

| | | |
|-------------|------------|--------|
| 8 PCS | BI-METAL | HSS M3 |
| ALLOY STEEL | 4-6 TPI | 40mm |



BMC & COLOR SLEEVE

| YATO | Ø (mm) | |
|---------|------------------------|----|
| YT-3380 | 22; 29; 35; 44; 67; 73 | 10 |

10

- GB Combination hole saw kit
- D Universal-Lochsägensatz
- PL Uniwersalny zestaw otwornic
- RUS Универсальный набор ножовок к отверстиям
- CZ Univerzální sada vrtacích korunek
- H Univerzális koronafúró készlet
- RO Set univesal de găuritori
- E Juego universal de sierras de marquetería
- CN 双金属开孔器组套

| | | |
|-------------|------------|--------|
| 15 PCS | BI-METAL | HSS M3 |
| ALLOY STEEL | 4-6 TPI | 40mm |



BMC & COLOR SLEEVE

| YATO | Ø (mm) | |
|---------|--|---|
| YT-3381 | 19; 22; 25; 32; 35; 38; 44; 51; 57; 64; 76 | 5 |

GB Hand tap
D Handgewindebohrer
PL Gwintownik ręczny
RUS Ручной метчик
CZ Závítníky
H Menetfúró
RO Tarozí
E Machos de roscar
CN 三件套手用丝锥



SLIDING
CARD



3
PCS

DIN
352

HSS
M2

3-STAGE
TAPPING
GWTOWANE
3-STOPNIOWE

METRIC
COARSE
GWT METRYCZNY
GRUBOZWOJNY

| YATO | size x pitch rozmiar x skok gwintu | thread length (mm) długość gwintu (mm) | L (mm) | shank diameter (mm) średnica trzonu (mm) | PCS packing | weight (g) waga (g) | |
|---------|---------------------------------------|---|--------|---|----------------|------------------------|---------|
| YT-2930 | M3x0.5 | 11 | 40 | 3.5 | 3 | 25 | 100/400 |
| YT-2931 | M4x0.7 | 13 | 45 | 4.5 | 3 | 35 | 50/200 |
| YT-2932 | M5x0.8 | 16 | 50 | 6.0 | 3 | 45 | 60/240 |
| YT-2933 | M6x1.0 | 19 | 50 | 6.0 | 3 | 45 | 60/240 |
| YT-2934 | M7x1.0 | 19 | 50 | 6.0 | 3 | 55 | 75/300 |
| YT-2935 | M8x1.25 | 22 | 56 | 6.0 | 3 | 60 | 50/200 |
| YT-2937 | M10x1.5 | 24 | 70 | 7.0 | 3 | 85 | 50/200 |
| YT-2939 | M12x1.75 | 29 | 75 | 9.0 | 3 | 125 | 50/200 |

| YATO | size x pitch rozmiar x skok gwintu | thread length (mm) długość gwintu (mm) | L (mm) | shank diameter (mm) średnica trzonu (mm) | PCS packing | weight (g) waga (g) | |
|---------|---------------------------------------|---|--------|---|----------------|------------------------|-------|
| YT-2940 | M14x2.0 | 30 | 80 | 10.5 | 3 | 200 | 20/80 |
| YT-2941 | M16x2.0 | 32 | 80 | 11.0 | 3 | 235 | 20/80 |
| YT-2942 | M18x2.5 | 40 | 95 | 12.0 | 3 | 345 | 20/80 |
| YT-2943 | M20x2.5 | 40 | 95 | 14.0 | 3 | 445 | 10/40 |
| YT-2926 | M22x2.5 | 40 | 100 | 18.0 | 3 | 600 | 10/40 |
| YT-2927 | M24x3.0 | 50 | 110 | 18.0 | 3 | 700 | 15/30 |
| YT-2928 | M27x3.0 | 50 | 110 | 20.0 | 3 | 950 | 15/30 |
| YT-2929 | M30x3.5 | 56 | 125 | 22.0 | 3 | 1100 | 10/20 |

GB Machine tap
D Maschinengewindebohrer
PL Gwintownik maszynowy
RUS Машинный метчик
CZ Strojní závítník

H Gépi menetfúró
RO Tarod de maşină
E Macho mecanico
CN 机用丝锥

DIN
371M

HSS
M2

1-STAGE
TAPPING
GWTOWANE
1-STOPNIOWE

METRIC
COARSE
GWT METRYCZNY
GRUBOZWOJNY

GB Machine tap
D Maschinengewindebohrer
PL Gwintownik maszynowy
RUS Машинный метчик
CZ Strojní závítník

H Gépi menetfúró
RO Tarod de maşină
E Macho mecanico
CN 机用丝锥

DIN
376

HSS
M2

1-STAGE
TAPPING
GWTOWANE
1-STOPNIOWE

METRIC
COARSE
GWT METRYCZNY
GRUBOZWOJNY



SLIDING
CARD



| YATO | size x pitch rozmiar x skok gwintu | thread length (mm) długość gwintu (mm) | L (mm) | shank diameter (mm) średnica trzonu (mm) | weight (g) waga (g) | |
|---------|---------------------------------------|---|--------|---|------------------------|---------|
| YT-2950 | M3x0.5 | 11 | 56 | 3.5 | 15 | 100/400 |
| YT-2951 | M4x0.7 | 13 | 63 | 4.5 | 20 | 100/400 |
| YT-2952 | M5x0.8 | 16 | 70 | 6.0 | 25 | 60/240 |
| YT-2953 | M6x1.0 | 19 | 80 | 6.0 | 30 | 50/200 |
| YT-2954 | M7x1.0 | 19 | 80 | 7.1 | 35 | 30/120 |
| YT-2955 | M8x1.25 | 22 | 90 | 8.0 | 45 | 50/200 |
| YT-2956 | M10x1.5 | 24 | 100 | 10.0 | 65 | 50/200 |

| YATO | size x pitch rozmiar x skok gwintu | thread length (mm) długość gwintu (mm) | L (mm) | shank diameter (mm) średnica trzonu (mm) | weight (g) waga (g) | |
|---------|---------------------------------------|---|--------|---|------------------------|--------|
| YT-2944 | M12x1.75 | 29 | 110 | 9.0 | 70 | 25/100 |
| YT-2945 | M14x2.0 | 30 | 110 | 11.0 | 110 | 25/100 |
| YT-2946 | M16x2.0 | 32 | 110 | 12.0 | 120 | 25/100 |
| YT-2947 | M18x2.5 | 34 | 125 | 14.0 | 200 | 25/100 |
| YT-2948 | M20x2.5 | 34 | 140 | 16.0 | 260 | 25/100 |
| YT-2949 | M22x2.5 | 34 | 140 | 18.0 | 340 | 20/80 |
| YT-2957 | M24x3.0 | 38 | 160 | 18.0 | 400 | 15/60 |
| YT-2958 | M27x3.0 | 38 | 160 | 20.0 | 500 | 15/60 |
| YT-2959 | M30x3.5 | 45 | 180 | 22.0 | 700 | 15/60 |

GB Taps and dies set
D Gewindefschneidwerkzeug-Satz
PL Zestaw narzynek i gwintowników
RUS Набор плашек и метчиков
CZ Souprava závítníků
a kruhových závítočných čelistí
H Menetfúró és menetvágó készlet
RO Set de tarozí şi filiere
E Juego de machosde
roscar y cojinetes
CN 丝锥板牙组套

METAL CASE
& COLOR BOX



HSS



44
PCS

DIN223
DIN225
DIN338
DIN352
DIN1814



YATO

size / rozmiar

YT-2978

M3; M4; M5; M6; M8; M10; M12

4

32
PCS

DIN223
DIN352



56
PCS

DIN223
DIN225
DIN352
DIN1814



YATO

size / rozmiar

YT-2979

M3; M4; M5; M6; M8; M10; M12; M14; M16; M18; M20

2

YATO

size / rozmiar

YT-2975

M3; M4; M5; M6; M8; M10; M12

10

GB Taps set
 D Gewindeschneidwerkzeug-Satz
 PL Zestaw gwintowników
 RUS Набор метчиков
 CZ Souprava závitníků
 H Menetfúró készlet
 RO Set de tarozi
 E Juego de machos de roscar
 CN 丝锥组套

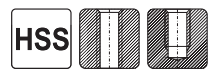

21
PCS

DIN
352

29
PCS

DIN338
DIN352
DIN1814



| YATO | size / rozmiar | |
|---------|------------------------------|----|
| YT-2976 | M3; M4; M5; M6; M8; M10; M12 | 20 |

| YATO | size / rozmiar | |
|---------|------------------------------|----|
| YT-2977 | M3; M4; M5; M6; M8; M10; M12 | 12 |

GB Circular die
 D Schneideisen
 PL Narzynka
 RUS Плашка

CZ Kruhová závitová čelist
 H Menetvágó
 RO Fileră

E Cojinete de roscar
 CN 圆板牙



SLIDING
CARD



| YATO | size x pitch rozmiar x skok gwintu | outside diameter (mm) średnica zewnętrzna (mm) | thickness (mm) grubość (mm) | weight (g) waga (g) | |
|---------|---------------------------------------|---|--------------------------------|------------------------|---------|
| YT-2961 | M4x0.7 | 20 | 5 | 20 | 125/500 |
| YT-2962 | M5x0.8 | 20 | 7 | 20 | 100/400 |
| YT-2963 | M6x1.0 | 20 | 7 | 20 | 100/400 |
| YT-2964 | M7x1.0 | 25 | 9 | 35 | 100/200 |
| YT-2965 | M8x1.25 | 25 | 9 | 35 | 100/400 |
| YT-2967 | M10x1.5 | 30 | 11 | 50 | 70/280 |
| YT-2969 | M12x1.75 | 38 | 14 | 90 | 60/240 |
| YT-2970 | M14x2.0 | 38 | 14 | 95 | 63/252 |

| YATO | size x pitch rozmiar x skok gwintu | outside diameter (mm) średnica zewnętrzna (mm) | thickness (mm) grubość (mm) | weight (g) waga (g) | |
|---------|---------------------------------------|---|--------------------------------|------------------------|--------|
| YT-2971 | M16x2.0 | 45 | 18 | 160 | 50/200 |
| YT-2972 | M18x2.5 | 45 | 18 | 160 | 50/200 |
| YT-2973 | M20x2.5 | 45 | 18 | 150 | 50/200 |
| YT-2960 | M22x2.5 | 55 | 22 | 300 | 20/80 |
| YT-2966 | M24x3.0 | 55 | 22 | 300 | 20/80 |
| YT-2968 | M27x3.0 | 65 | 25 | 400 | 15/60 |
| YT-2974 | M30x3.5 | 65 | 25 | 400 | 15/60 |

GB T-handle tap wrench
 D Werkzeughalter für Gewinde
 PL Pokrętko typu „T”
 do gwintowników
 RUS Рукоятка типа „Т”
 к гаечному ключу
 CZ Vratidlo na závitníky typ „T”
 H Menetfúró befogó T-nyelű
 RO Port tarod cu maner
 E Llave giramachos „T”
 CN 丝锥铰手



SLIDING
CARD

| YATO | size / rozmiar | L (mm) | |
|---------|----------------|--------|-------|
| YT-2986 | M3-M8 | 70 | 20/80 |
| YT-2987 | M5-M10 | 80 | 20/80 |
| YT-2988 | M6-M12 | 90 | 20/80 |

GB Ratchet tap wrench
 D Werkzeughalter
 PL Grzechołka do gwintownika
 RUS Трещетка для метчика
 CZ Řečtačka na závitník
 H Racsnis hajtószár menetfúróhoz
 RO Port tarod
 E Carraca para macho de roscar
 CN 棘轮丝锥铰手



SLIDING
CARD

| YATO | size / rozmiar | L (mm) | |
|---------|----------------|--------|-------|
| YT-2989 | M3-M10 | 85 | 20/80 |
| YT-2997 | M3-M10 | 250 | 20/80 |
| YT-2990 | M5-M12 | 100 | 20/80 |
| YT-2991 | M5-M12 | 300 | 20/40 |

GB Die handle
 D Schneideisenhalter
 PL Oprawa do narzynek
 RUS Плашкодержатель

CZ Závitová objímka
 H Menetvágó tartó
 RO Portfileră

E Portacojinete
 CN 板牙铰手



SLIDING
CARD

| YATO | size / rozmiar | Ø (mm) | L (mm) | |
|---------|----------------|--------|--------|--------|
| YT-2980 | M3-M4 | 20x5 | 200 | 25/100 |
| YT-2981 | M4.5-M6 | 20x7 | 200 | 25/100 |
| YT-2982 | M7-M9 | 25x9 | 224 | 25/100 |
| YT-2983 | M10-M11 | 30x11 | 280 | 25/50 |
| YT-2984 | M12-M14 | 38x14 | 315 | 15/30 |
| YT-2985 | M16-M20 | 45x18 | 450 | 10/20 |

GB Tap wrench
 D Werkzeughalter für Gewinde
 PL Pokrętko do gwintowników

RUS Вороток для метчиков
 CZ Ovládací kolečko na závitník
 H Hajtószár menetfúróhoz

RO Cheie (măner) pt. tarod
 E Llave giramachos
 CN 一型丝锥铰手



SLIDING
CARD

| YATO | size / rozmiar | L (mm) | |
|---------|----------------|--------|--------|
| YT-2995 | M1-M8 | 125 | 50/200 |
| YT-2996 | M3-M10 | 180 | 25/100 |
| YT-2992 | M3-M12 | 200 | 25/100 |
| YT-2993 | M4-M12 | 280 | 25/100 |
| YT-2994 | M5-M20 | 375 | 20/40 |

- GB Thread repair set
D Reparatursatz für Gewinde
PL Zestaw do naprawy gwintów
RUS Набор для ремонта резьбы
CZ Souprava na opravu závitů
- H Menetjavító készlet
RO Set pt. reparare filete
E Juego para reparar roscas
CN 螺纹修复组套





METAL BOX
& COLOR BOX

HSS
4341

STAINLESS
STEEL
NEROZEWA





88
PCS

| YATO  | size / rozmiar |  |
|--|---------------------|---|
| YT-1769 | M6 x 1.0 x 10.8 mm | 5/10 |
| | M8 x 1.25 x 10.8 mm | |
| | M10 x 1.5 x 13.5 mm | |



131
PCS

| YATO  | size / rozmiar |  |
|--|----------------------|---|
| YT-1763 | M5 x 0.8 x 6.7 mm | 5/10 |
| | M6 x 1.0 x 10.8 mm | |
| | M8 x 1.25 x 10.8 mm | |
| | M10 x 1.5 x 13.5 mm | |
| | M12 x 1.75 x 16.3 mm | |

for / dla: YT-1763, YT-1769



STAINLESS
STEEL
NEROZEWA

- GB Wire threads
D Spiraleinlagen für Gewindereparatur
PL Wkłady spiralne do naprawy gwintów
RUS Метчики и сверла для ремонта резьбы
CZ Spirálové vložky na opravu závitů
H Menetjavító betétek
RO Insertii spirală pt. reparare filete
E Elementos espirales para reparar roscas
CN 螺纹修复组套



POLYBAG
WITH
HEADER



| YATO  | size / rozmiar | PCS packing |  |
|--|----------------------|----------------|---|
| YT-1764 | M5 x 0.8 x 6.7 mm | 20 | 50/250 |
| YT-1765 | M6 x 1.0 x 10.8 mm | 20 | 50/250 |
| YT-1766 | M8 x 1.25 x 10.8 mm | 20 | 50/200 |
| YT-1767 | M10 x 1.5 x 13.5 mm | 15 | 25/100 |
| YT-1768 | M12 x 1.75 x 16.3 mm | 10 | 25/100 |

- GB Router bit set
- D Oberfräsersatz
- PL Zestaw frezów do drewna
- RUS Набор фрез по дереву
- CZ Souprava frézů do dřeva
- H Medtjö frez komplektas
- RO Set de freze pt. lemn
- E Juego de frezas para madera
- CN 木工铣刀组套



ALUMINIUM CASE & COLOR SLEEVE





±0.08 mm

YG6X
TUNGSTEN CARBIDE
HIEŁAK WOLFPRÄG



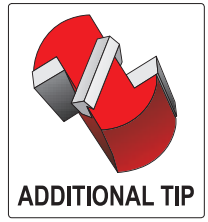



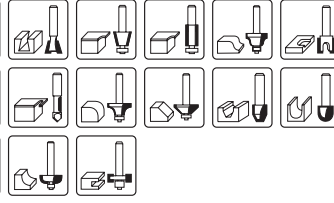







24 PCS



























YT-6801















10

| Router bit parameter |  |  |  |  |  |  |  |  |  |  | | |
|--------------------------|---|---|---|--|---|---|---|---|---|---|---|---|
| Shank diameter [mm] | 8 | 8 | 8 | 8 | 8 | 8 | 8 | 8 | 8 | 8 | 8 | 8 |
| Length [mm] | 42.0 | 47.0 | 47.0 | 43.5 | 50.0 | 51.5 | 51.0 | 52.0 | 58.0 | 51.5 | 58.0 | 56.5 |
| Router bit diameter [mm] | 12.7 | 12.7 | 9.5 | 12.7 | 12.7 | 9.5 | 12.7 | 16.0 | 6.35 | 6.35 | 9.5 | 12.7 |
| Cutting edge length [mm] | 12.7 | 14.8 | 11.6 | 13.0 | 12.5 | 20.0 | 20.0 | 9.5 | 19.5 | 20.0 | 24.5 | 25.0 |
| Curvature radius [mm] | - | - | - | - | - | 4.75 | 6.35 | - | - | - | - | - |
| Bearing diameter [mm] | - | - | - | - | - | - | - | 12.7 | - | - | - | - |
| Angle [°] | - | 15 | 10 | - | 45 | - | - | 15 | - | - | - | - |

| Router bit parameter |  |  |  |  |  |  |  |  |  |  | | |
|--------------------------|---|---|---|--|---|---|---|---|---|---|---|---|
| Shank diameter [mm] | 8 | 8 | 8 | 8 | 8 | 8 | 8 | 8 | 8 | 8 | 8 | 8 |
| Length [mm] | 52.0 | 65.0 | 51.0 | 51.5 | 53.5 | 57.5 | 50.5 | 53.5 | 52.0 | 55.0 | 50.0 | 54.0 |
| Router bit diameter [mm] | 19.0 | 12.7 | 19.0 | 22.0 | 26.0 | 32.0 | 22.0 | 28.5 | 27.0 | 30.0 | 32.0 | 32.0 |
| Cutting edge length [mm] | 20.4 | 25.0 | 9.5 | 10.0 | 11.5 | 16.5 | 9.72 | 13.5 | 12.3 | 14.0 | 6.35 | 12.7 |
| Curvature radius [mm] | - | - | 3.2 | 4.76 | 6.35 | 9.5 | 6.35 | 9.5 | 4.0 | - | - | - |
| Bearing diameter [mm] | - | 12.7 | - | 12.7 | 12.7 | 12.7 | 9.5 | 9.5 | 9.5 | 12.7 | 12.7 | 12.7 |
| Angle [°] | - | - | - | - | - | - | - | - | - | 45 | - | - |



| Router bit parameter |  |  |  |  |  |  |  |  |  |  |  |  |  | | | | | |
|--------------------------|---|---|---|---|---|---|---|---|---|---|---|---|---|---|---|---|------|------|
| Shank diameter [mm] | 8 | 8 | 8 | 8 | 8 | 8 | 8 | 8 | 8 | 8 | 8 | 8 | 8 | 8 | 8 | 8 | | |
| Length [mm] | 43.0 | 38.0 | 38.0 | 50.5 | 42.0 | 43.5 | 51.5 | 49.5 | 51.5 | 58.0 | 58.5 | 56.5 | 52.0 | 58.0 | 53.5 | 66.0 | 53.0 | 65.0 |
| Router bit diameter [mm] | 6.35 | 12.7 | 12.7 | 12.7 | 12.7 | 12.7 | 14.3 | 3.175 | 6.35 | 9.5 | 12.7 | 12.7 | 19.0 | 6.35 | 9.5 | 9.5 | 12.7 | 12.7 |
| Cutting edge length [mm] | 6.0 | 9.5 | 9.5 | 18.0 | 12.7 | 13.0 | 12.3 | 13.0 | 20.0 | 24.5 | 20.3 | 25.0 | 20.4 | 19.5 | 15.0 | 26.0 | 15.0 | 25.0 |
| Curvature radius [mm] | 3.175 | 6.35 | - | 6.35 | - | - | - | - | - | - | - | - | - | - | - | - | - | - |
| Bearing diameter [mm] | - | - | - | - | - | - | - | - | - | - | - | - | - | - | 9.5 | 9.5 | 12.7 | 12.7 |
| Angle [°] | - | - | 45 | - | - | 10 | 14 | - | - | - | - | - | - | - | - | - | - | - |

| Router bit parameter |  |  |  |  |  |  |  |  |  |  |  |  |  | | | | | |
|--------------------------|---|---|---|---|---|---|---|---|---|---|---|---|---|------|------|------|------|---|
| Shank diameter [mm] | 8 | 8 | 8 | 8 | 8 | 8 | 8 | 8 | 8 | 8 | 8 | 8 | 8 | | | | | |
| Length [mm] | 65.5 | 55.0 | 51.0 | 55.0 | 50.0 | 52.5 | 54.0 | 55.5 | 60.0 | 60.0 | 56.0 | 60.0 | 52.5 | 58.0 | 53.5 | 57.5 | 61.0 | - |
| Router bit diameter [mm] | 19.0 | 30.0 | 26.0 | 32.0 | 32.0 | 32.0 | 32.0 | 32.0 | 38.0 | 32.0 | 38.0 | 26.0 | 38.0 | 26.0 | 32.0 | 38.0 | - | - |
| Cutting edge length [mm] | 26.0 | 14.0 | 9.7 | 13.3 | 6.35 | 8.0 | 9.5 | 15.0 | 18.5 | 20.0 | 16.0 | 19.0 | 12.5 | 17.8 | 11.5 | 16.5 | 20.8 | - |
| Curvature radius [mm] | - | - | 6.35 | 9.5 | - | - | - | 8.0 | 4.76 | 12.7 | 4.76 | 6.35 | 3.175 | 6.35 | 6.35 | 9.5 | 12.7 | - |
| Bearing diameter [mm] | 19.0 | 12.7 | 12.7 | 12.7 | 12.7 | 12.7 | 12.7 | 9.5 | 12.7 | 9.5 | 9.5 | 9.5 | 9.5 | 9.5 | 12.7 | 12.7 | 12.7 | - |
| Angle [°] | - | 45 | - | - | - | - | - | - | - | - | - | - | - | - | - | - | - | - |

35 PCS

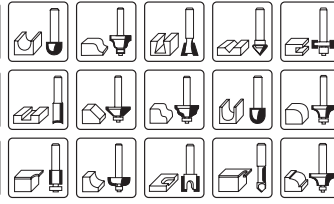



YT-6803

10

GB Diamond blade
D Diamant-Trennscheibe
PL Tarcza diamentowa
RUS Отрезной алмазный диск
CZ Diamantový kotouč

H Gyémántkorong
RO Disc cu diamant
E Disco de diamante
CN 金刚石切片

DOUBLE
BLISTER

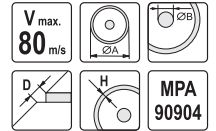

- application: concrete, brick, tile, masonry, stone
- przeznaczenie: beton utwardzony, cegła, granit, mur, kamień

- application: ceramic, glaze, glass, porcelain
- przeznaczenie: płytki ceramiczne, glazura, płytki kamienne, szkło, porcelana

- application: concrete, brick, tile, masonry, stone, sandstone
- przeznaczenie: beton utwardzony, cegła, granit, mur, kamień, piaskowiec

| YATO | ØA (mm) | ØB (mm) | R.P.M.max. | D (mm) | H (mm) | |
|---------|---------|---------|------------|--------|--------|--------|
| YT-6002 | 115 | 22.2 | 12000 | 2.1 | 8.0 | 20/200 |
| YT-6003 | 125 | 22.2 | 11000 | 2.2 | 8.0 | 20/160 |
| YT-6004 | 180 | 22.2 | 8000 | 2.5 | 8.0 | 15/60 |
| YT-6005 | 230 | 22.2 | 6500 | 2.7 | 8.0 | 10/40 |

| YATO | ØA (mm) | ØB (mm) | R.P.M.max. | D (mm) | H (mm) | |
|---------|---------|---------|------------|--------|--------|--------|
| YT-6012 | 115 | 22.2 | 12000 | 2.1 | 5.3 | 20/200 |
| YT-6013 | 125 | 22.2 | 11000 | 2.2 | 5.3 | 20/160 |
| YT-6014 | 180 | 22.2 | 8000 | 2.5 | 5.3 | 15/60 |
| YT-6015 | 230 | 22.2 | 6500 | 2.7 | 5.3 | 10/40 |
| YT-6016 | 180 | 25.4 | 8000 | 2.2 | 5.3 | 15/60 |
| YT-6017 | 200 | 25.4 | 8000 | 2.2 | 5.3 | 10/40 |

| YATO | ØA (mm) | ØB (mm) | R.P.M.max. | D (mm) | H (mm) | |
|---------|---------|---------|------------|--------|--------|--------|
| YT-6022 | 115 | 22.2 | 12000 | 2.4 | 8.0 | 20/200 |
| YT-6023 | 125 | 22.2 | 11000 | 2.6 | 8.0 | 20/160 |
| YT-6024 | 180 | 22.2 | 8000 | 2.8 | 8.0 | 15/60 |
| YT-6025 | 230 | 22.2 | 6500 | 3.1 | 8.0 | 10/40 |

GB Diamond blade
D Diamant-Trennscheibe
PL Tarcza diamentowa
RUS Отрезной алмазный диск
CZ Diamantový kotouč

H Gyémántkorong
RO Disc cu diamant
E Disco de diamante
CN 金刚石切片



10



DOUBLE BLISTER



PAPER ENVELOPE



- application: concrete, reinforced concrete, clinkier, brick
- przeznaczenie: beton, beton zbrojony, klinkier, cegła

- application: concrete, reinforced concrete, clinkier, brick
- przeznaczenie: beton, beton zbrojony, klinkier, cegła

| YATO | ØA (mm) | ØB (mm) | R.P.M.max. | D (mm) | H (mm) | |
|---------|---------|---------|------------|--------|--------|----|
| YT-5953 | 300 | 25.4 | 5100 | 3.0 | 10.0 | 10 |
| YT-5954 | 350 | 25.4 | 4300 | 3.2 | 10.0 | 5 |
| YT-5955 | 400 | 25.4 | 3800 | 3.6 | 10.0 | 5 |

| YATO | ØA (mm) | ØB (mm) | R.P.M.max. | D (mm) | H (mm) | |
|---------|---------|---------|------------|--------|--------|---|
| YT-5956 | 450 | 25.4 | 3400 | 3.8 | 10.0 | 5 |



DOUBLE BLISTER



PAPER ENVELOPE



- application: natural stone, artificial stone
- przeznaczenie: kamień naturalny, kamień sztuczny

- application: natural stone, artificial stone
- przeznaczenie: kamień naturalny, kamień sztuczny

| YATO | ØA (mm) | ØB (mm) | R.P.M.max. | D (mm) | H (mm) | |
|---------|---------|---------|------------|--------|--------|----|
| YT-5963 | 300 | 25.4 | 5100 | 3.0 | 10.0 | 10 |
| YT-5964 | 350 | 25.4 | 4300 | 3.2 | 10.0 | 5 |
| YT-5965 | 400 | 25.4 | 3800 | 3.6 | 10.0 | 5 |

| YATO | ØA (mm) | ØB (mm) | R.P.M.max. | D (mm) | H (mm) | |
|---------|---------|---------|------------|--------|--------|---|
| YT-5966 | 450 | 25.4 | 3400 | 3.8 | 10.0 | 5 |

GB Diamond blade
 D Diamant-Trennscheibe
 PL Tarcza diamentowa
 RUS Отрезной алмазный диск
 CZ Diamantový kotouč

H Gyémántkorong
 RO Disc cu diamant
 E Disco de diamante
 CN 金刚石切片



DOUBLE BLISTER



• application: ceramic tiles, thin natural stone tiles, glaze, glass, porcelain

• przeznaczenie: płytki ceramiczne, cienkie płytki z naturalnego kamienia, glazura, szkło, porcelana



DOUBLE BLISTER



• application: ceramic materials

• przeznaczenie: materiały ceramiczne

| YATO | ØA (mm) | ØB (mm) | Ø R.P.M.max. | D (mm) | H (mm) | Box |
|---------|---------|---------|--------------|--------|--------|-----|
| YT-5973 | 250 | 25.4 | 6100 | 1.8 | 10.0 | 20 |
| YT-5974 | 300 | 25.4 | 5100 | 2.1 | 10.0 | 10 |
| YT-5975 | 350 | 25.4 | 4300 | 2.4 | 10.0 | 5 |

| YATO | ØA (mm) | ØB (mm) | Ø R.P.M.max. | D (mm) | H (mm) | Box |
|---------|---------|---------|--------------|--------|--------|-----|
| YT-5982 | 250 | 25.4 | 6100 | 2.6 | 10.0 | 20 |
| YT-5983 | 300 | 25.4 | 5100 | 3.2 | 10.0 | 10 |
| YT-5984 | 350 | 25.4 | 4300 | 3.2 | 10.0 | 5 |



• application: asphalt, checker brick, silicate, chamotte, fresh concrete materials, other ceramic building materials

• przeznaczenie: asfalt, cegła „kratówka”, silikaty, szamot, świeży beton, inne ścierealne materiały budowlane

DOUBLE BLISTER



• application: asphalt, checker brick, silicate, chamotte, fresh concrete materials, other ceramic building materials

• przeznaczenie: asfalt, cegła „kratówka”, silikaty, szamot, świeży beton, inne ścierealne materiały budowlane

PAPER ENVELOPE

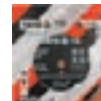

| YATO | ØA (mm) | ØB (mm) | Ø R.P.M.max. | D (mm) | H (mm) | Box |
|---------|---------|---------|--------------|--------|--------|-----|
| YT-5991 | 300 | 25.4 | 5100 | 3.2 | 10.0 | 10 |
| YT-5992 | 350 | 25.4 | 4300 | 3.2 | 10.0 | 5 |

| YATO | ØA (mm) | ØB (mm) | Ø R.P.M.max. | D (mm) | H (mm) | Box |
|---------|---------|---------|--------------|--------|--------|-----|
| YT-5994 | 450 | 25.4 | 3400 | 3.6 | 10.0 | 5 |

GB Diamond grinding cup wheel
 D Diamant Schleiftopf Schleifteller
 PL Tarcza szliflerska diamentowa
 RUS Алмазный диск шлифовальный
 CZ Diamantový brusný kotouč
 H Gyémánt csiszoló kúpos
 RO Disc cupa diamantat pt. slefuit
 E Disco diamante de lijir
 CN 金刚石杯型磨轮

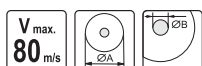

HANGING COLOR BOX



• application: concrete, clinker, natural stone
 • przeznaczenie: beton, klinkier, kamień naturalny

| YATO | ØA (mm) | ØB (mm) | Ø R.P.M.max. | segment size (mm) | Box |
|---------|---------|---------|--------------|-------------------|-----|
| YT-6030 | 125 | 22.2 | 12200 | 5.0x7.5 | 20 |
| YT-6032 | 125 | 22.2 | 12200 | 4.5x20.0 | 20 |

GB Diamond core bit drilling holes for sockets
 D Diamant-Bohrkrone
 PL Diamentowe wiertło koronowe
 RUS Алмазное сверло корончатое
 CZ Diamantový korunkový vrták
 H Gyémánt fúrókorona
 RO Carota diamantata pt. beton
 E Corona con broca diamante
 CN 金刚石薄壁钻



COLOR BOX



| YATO | Ø (mm) | Ø R.P.M.max. | segment size (mm) | Box |
|---------|--------|--------------|-------------------|-----|
| YT-6045 | 68 | 1030 | 3.5x10x24 | 24 |
| YT-6046 | 82 | 850 | 3.5x10x24 | 20 |

GB TCT circular saw blade for wood
D Kreissägeblatt HM-Bestückt
PL Piła tarczowa do drewna z węglikiem wolframu
RUS Диск пильный с карбидом вольфрама

CZ Kotoučová pila na dřevo z karbidem wolframu
H Wolframkarbidos körfűrész fához
RO Ferăstrău circular cu dinți din wolfram pt. lemn

E Disco de sierra con carbono de tungsteno
CN 木工锯片

DOUBLE BLISTER



- application: for cutting wood and plastics
- przeznaczenie: do cięcia drewna, płyt drewnopochodnych, tworzyw sztucznych

| YATO | ∅ (mm) | d (mm) | R.P.M.max. | D (mm) | thickness of blade / grubość ostrza | T | ∅ |
|---------|--------|--------|------------|--------|-------------------------------------|----|-------|
| YT-6050 | 130 | 16.0 | 10000 | 2.8 | 2.0 | 24 | 25/50 |
| YT-6052 | 140 | 20.0 | 10000 | 2.8 | 2.0 | 16 | 25/50 |
| YT-6053 | 140 | 16.0 | 10000 | 2.8 | 2.0 | 30 | 25/50 |
| YT-6055 | 160 | 20.0 | 9500 | 2.8 | 2.0 | 18 | 25/50 |
| YT-6056 | 160 | 30.0 | 9500 | 2.8 | 2.0 | 24 | 25/50 |
| YT-6057 | 160 | 30.0 | 9500 | 2.8 | 2.0 | 36 | 25/50 |
| YT-6058 | 160 | 20.0 | 9500 | 2.8 | 2.0 | 48 | 25/50 |
| YT-6060 | 184 | 30.0 | 9000 | 3.2 | 2.2 | 24 | 25/50 |
| YT-6061 | 184 | 30.0 | 9000 | 3.2 | 2.2 | 40 | 25/50 |
| YT-6062 | 184 | 30.0 | 9000 | 3.2 | 2.2 | 50 | 25/50 |
| YT-6063 | 185 | 20.0 | 9000 | 2.4 | 1.4 | 18 | 25/50 |
| YT-6065 | 200 | 30.0 | 8000 | 3.2 | 2.2 | 24 | 10/20 |
| YT-6066 | 205 | 18.0 | 6000 | 3.2 | 2.0 | 24 | 10/20 |
| YT-6067 | 210 | 30.0 | 8000 | 3.2 | 2.2 | 40 | 10/20 |

| YATO | ∅ (mm) | d (mm) | R.P.M.max. | D (mm) | thickness of blade / grubość ostrza | T | ∅ |
|---------|--------|--------|------------|--------|-------------------------------------|----|-------|
| YT-6068 | 210 | 30.0 | 8000 | 3.2 | 2.2 | 60 | 10/20 |
| YT-6070 | 250 | 30.0 | 6000 | 3.2 | 2.2 | 24 | 10/20 |
| YT-6071 | 250 | 30.0 | 6000 | 3.2 | 2.2 | 40 | 10/20 |
| YT-6072 | 250 | 30.0 | 6000 | 3.2 | 2.2 | 60 | 10/20 |
| YT-6075 | 300 | 30.0 | 6000 | 3.2 | 2.2 | 24 | 10 |
| YT-6076 | 300 | 30.0 | 5000 | 3.2 | 2.2 | 40 | 10 |
| YT-6077 | 300 | 30.0 | 5000 | 3.2 | 2.2 | 60 | 10 |
| YT-6078 | 300 | 30.0 | 5000 | 3.2 | 2.2 | 96 | 10 |
| YT-6080 | 350 | 30.0 | 4500 | 3.5 | 2.5 | 28 | 10 |
| YT-6081 | 350 | 30.0 | 4500 | 3.5 | 2.5 | 40 | 10 |
| YT-6082 | 350 | 30.0 | 4500 | 3.5 | 2.5 | 54 | 10 |
| YT-6083 | 350 | 30.0 | 4500 | 3.5 | 2.5 | 84 | 10 |
| YT-6085 | 400 | 30.0 | 4000 | 3.8 | 2.8 | 32 | 10 |
| YT-6086 | 400 | 30.0 | 4000 | 3.8 | 2.8 | 60 | 10 |

GB TCT circular saw blade for aluminium
D Hartmetallbestückt Kreissägeblatt für Aluminium
PL Piła tarczowa do aluminium z węglikiem wolframu

RUS Диск пильный по алюминию
CZ Kotoučová pila na hliník s karbidem wolframu
H Wolframkarbidos körfűrészlap, alumíniumhoz

RO Disc circular pt. aluminiu
E Disco de sierra con carbono
CN 锯片

DOUBLE BLISTER



- application: for cutting aluminium profiles, laminates, plexi, corian and other plastics
- negative angle of teeth
- przeznaczenie: do cięcia profili aluminiowych, laminatów, plexi, korianu, tworzyw sztucznych
- negatywny kąt natarcia zębów

| YATO | ∅ (mm) | d (mm) | R.P.M.max. | D (mm) | thickness of blade / grubość ostrza | T | ∅ |
|---------|--------|--------|------------|--------|-------------------------------------|-----|-------|
| YT-6091 | 200 | 30 | 8000 | 3.0 | 2.2 | 60 | 10/20 |
| YT-6093 | 210 | 30 | 8000 | 3.0 | 2.2 | 72 | 10/20 |
| YT-6095 | 250 | 30 | 6000 | 3.0 | 2.2 | 100 | 10/20 |

| YATO | ∅ (mm) | d (mm) | R.P.M.max. | D (mm) | thickness of blade / grubość ostrza | T | ∅ |
|---------|--------|--------|------------|--------|-------------------------------------|-----|----|
| YT-6097 | 300 | 30 | 5000 | 3.0 | 2.2 | 100 | 10 |
| YT-6099 | 350 | 30 | 4500 | 3.2 | 2.5 | 100 | 10 |

GB Metal cutting disc
D Trennscheibe für Metall
PL Tarcza do cięcia metalu

RUS Диск отрезной по металлу
CZ Kotouč pro řezání kovu
H Vágókorong fémhez

RO Disc debitat metale
E Disco cortador para metalo
CN 锯片

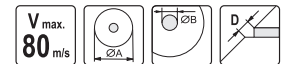

INOX

INOX

• depressed center • wypukła

| YATO | ∅A (mm) | ∅B (mm) | D (mm) | R.P.M.max. | PCS packing | ∅ |
|---------|---------|---------|--------|------------|-------------|--------|
| YT-6101 | 115 | 22 | 1.2 | 13200 | 5 | 25/200 |
| YT-6102 | 115 | 22 | 2.5 | 13200 | 5 | 25/200 |
| YT-6103 | 125 | 22 | 1.2 | 12200 | 5 | 25/200 |
| YT-6104 | 125 | 22 | 2.5 | 12200 | 5 | 25/200 |
| YT-6105 | 180 | 22 | 1.5 | 8600 | 5 | 25/50 |
| YT-6106 | 180 | 22 | 2.5 | 8600 | 5 | 25/100 |
| YT-6107 | 230 | 22 | 2.0 | 6500 | 5 | 25/50 |
| YT-6108 | 230 | 22 | 3.2 | 6500 | 5 | 25/50 |

| YATO | ∅A (mm) | ∅B (mm) | D (mm) | R.P.M.max. | PCS packing | ∅ |
|---------|---------|---------|--------|------------|-------------|--------|
| YT-5940 | 115 | 22 | 2.5 | 13200 | 5 | 25/200 |
| YT-5941 | 115 | 22 | 3.2 | 13200 | 5 | 25/200 |
| YT-5942 | 125 | 22 | 2.5 | 12200 | 5 | 25/200 |
| YT-5943 | 125 | 22 | 3.2 | 12200 | 5 | 25/200 |
| YT-5944 | 180 | 22 | 3.2 | 8600 | 5 | 25/50 |
| YT-5945 | 230 | 22 | 3.2 | 6500 | 5 | 25/50 |

| YATO | ∅A (mm) | ∅B (mm) | D (mm) | R.P.M.max. | PCS packing | ∅ |
|---------|---------|---------|--------|------------|-------------|--------|
| YT-5920 | 115 | 22 | 1.2 | 13200 | 5 | 25/200 |
| YT-5921 | 115 | 22 | 2.5 | 13200 | 5 | 25/200 |
| YT-5922 | 115 | 22 | 3.2 | 13200 | 5 | 25/200 |
| YT-5923 | 125 | 22 | 1.2 | 12200 | 5 | 25/200 |
| YT-5924 | 125 | 22 | 2.5 | 12200 | 5 | 25/200 |
| YT-6110 | 125 | 22 | 3.2 | 12200 | 5 | 25/200 |
| YT-5925 | 180 | 22 | 1.5 | 8600 | 5 | 25/50 |
| YT-5926 | 180 | 22 | 2.5 | 8600 | 5 | 25/50 |
| YT-6111 | 180 | 22 | 3.2 | 8600 | 5 | 25/100 |
| YT-5927 | 230 | 22 | 2.0 | 6500 | 5 | 25/50 |
| YT-6112 | 230 | 22 | 3.2 | 6500 | 5 | 25/50 |
| YT-6113 | 300 | 32 | 3.2 | 5100 | 5 | 25 |
| YT-6122 | 305 | 22 | 3.5 | 5100 | 5 | 10/20 |
| YT-6136 | 350 | 32 | 3.5 | 4400 | 5 | 25 |
| YT-6137 | 400 | 32 | 4.0 | 3800 | 5 | 25 |

GB Metal cutting disc
 D Trennscheibe für Metall
 PL Tarcza do cięcia metalu
 RUS Диск отрезной по металлу
 CZ Kotouč pro řezání kovu
 H Vágókorong fémhez
 RO Disc debitat metale
 E Disco cortador para metalo
 CN 树脂切片

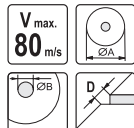

• depressed center • wypukła

| YATO | ∅A (mm) | ∅B (mm) | D (mm) | ∅ R.P.M.max. | PCS packing | Box |
|---------|---------|---------|--------|--------------|-------------|--------|
| YT-6114 | 115 | 22 | 2.5 | 13200 | 5 | 25/200 |
| YT-6115 | 115 | 22 | 3.2 | 13200 | 5 | 25/200 |
| YT-6116 | 125 | 22 | 2.5 | 12200 | 5 | 25/200 |
| YT-6117 | 125 | 22 | 3.2 | 12200 | 5 | 25/200 |
| YT-6119 | 180 | 22 | 3.2 | 8600 | 5 | 25/100 |
| YT-6120 | 230 | 22 | 3.2 | 6500 | 5 | 25/50 |

GB Metal grinding disc
 D Metall-Schleifscheibe
 PL Tarcza do szlifowania metalu
 RUS Круги для шлифования по металлу
 CZ Kotouč pro broušení kovu

H Vágókorong fémhez
 RO Disc pt. șlefuit metal
 E Disco cortador para metalo
 CN 锯片

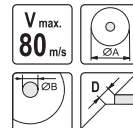

• depressed center • wypukła

| YATO | ∅A (mm) | ∅B (mm) | D (mm) | ∅ R.P.M.max. | PCS packing | Box |
|---------|---------|---------|--------|--------------|-------------|--------|
| YT-6121 | 115 | 22 | 6.0 | 13200 | 5 | 25/100 |
| YT-6123 | 115 | 22 | 8.0 | 13200 | 5 | 25/100 |
| YT-6124 | 125 | 22 | 6.0 | 12200 | 5 | 30/120 |
| YT-6126 | 125 | 22 | 8.0 | 12200 | 5 | 25/100 |
| YT-6138 | 180 | 22 | 6.8 | 8600 | 5 | 15/30 |
| YT-6139 | 180 | 22 | 8.0 | 8600 | 5 | 15/30 |
| YT-6125 | 230 | 22 | 6.0 | 6500 | 5 | 5/30 |
| YT-6127 | 230 | 22 | 8.0 | 6500 | 5 | 15/30 |



INOX

• depressed center • wypukła

| YATO | ∅A (mm) | ∅B (mm) | D (mm) | ∅ R.P.M.max. | PCS packing | Box |
|---------|---------|---------|--------|--------------|-------------|--------|
| YT-5946 | 115 | 22 | 6.0 | 13200 | 5 | 25/100 |
| YT-5947 | 125 | 22 | 6.8 | 12200 | 5 | 25/100 |
| YT-5948 | 180 | 22 | 6.8 | 8600 | 5 | 15/30 |
| YT-5949 | 230 | 22 | 6.8 | 6500 | 5 | 15/30 |

GB Stone cutting disc
 D Trennscheibe für Stein
 PL Tarcza do cięcia kamienia
 RUS Диск отрезной по камню
 CZ Kotouč pro řezání kamene

H Vágókorong kőhöz
 RO Disc pt. tăiat piatră
 E Disco cortador de piedra
 CN 石材锯片

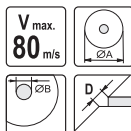

• depressed center • wypukła

| YATO | ∅A (mm) | ∅B (mm) | D (mm) | ∅ R.P.M.max. | PCS packing | Box |
|---------|---------|---------|--------|--------------|-------------|--------|
| YT-5930 | 115 | 22 | 1.5 | 13200 | 5 | 25/200 |
| YT-5931 | 115 | 22 | 3.2 | 13200 | 5 | 25/200 |
| YT-5932 | 125 | 22 | 1.5 | 12200 | 5 | 25/200 |
| YT-5933 | 125 | 22 | 3.2 | 12200 | 5 | 25/200 |
| YT-5934 | 180 | 22 | 3.2 | 8600 | 5 | 25/50 |
| YT-5935 | 230 | 22 | 3.2 | 6500 | 5 | 25/50 |
| YT-5936 | 300 | 22 | 3.5 | 5100 | 5 | 25 |
| YT-5937 | 350 | 22 | 4.0 | 4400 | 5 | 25 |

GB Stone grinding disc
 D Stein-schleifscheibe
 PL Tarcza do szlifowania kamienia
 RUS Диск для шлифования по камню
 CZ Kotouč pro broušení kamene
 H Csiszolókorong kőhöz
 RO Disc pt. șlefuit piatră
 E Disco cortador de piedra
 CN 锯片

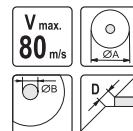

• depressed center • wypukła

| YATO | ∅A (mm) | ∅B (mm) | D (mm) | ∅ R.P.M.max. | PCS packing | Box |
|---------|---------|---------|--------|--------------|-------------|--------|
| YT-6128 | 115 | 22 | 3.2 | 13200 | 5 | 25/200 |
| YT-6129 | 125 | 22 | 3.2 | 12200 | 5 | 25/200 |
| YT-6130 | 180 | 22 | 3.2 | 8600 | 5 | 25/100 |
| YT-6131 | 230 | 22 | 3.2 | 6500 | 5 | 25/50 |
| YT-6132 | 115 | 22 | 6.0 | 13200 | 5 | 25/100 |
| YT-6133 | 125 | 22 | 6.8 | 12200 | 5 | 25/100 |
| YT-6134 | 180 | 22 | 6.8 | 8600 | 5 | 15/30 |
| YT-6135 | 230 | 22 | 6.8 | 6500 | 5 | 15/30 |

GB Cable cutter
D Kabelschere
PL Szczypce do cięcia przewodów
RUS Кабелерезы
CZ Elektrické upichováky
H Kábelvágó
RO Patent tăietor pt. electric
E Tijeras para cables
CN 电缆剪

SLIDING CARD

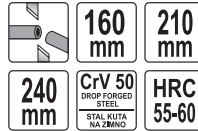

160 mm
210 mm

240 mm
CrV 50
DROP FORGED STEEL
STAL KUTA NA ZMNO
HRC 55-60



- application: for copper and aluminium electric cables
- przeznaczenie: do cięcia miedzianych i aluminiowych kabli

| YATO | L (mm) | max. Ø (mm) | |
|---------|--------|-------------|------|
| YT-1966 | 160 | 6 | 6/60 |
| YT-1967 | 210 | 7 | 6/60 |
| YT-1968 | 240 | 8 | 6/48 |

GB Tin snips
D Blechscher
PL Nożyce do cięcia blachy
RUS Ножницы по металлу
CZ Nůžky na plech
H Lemezvágó olló
RO Foarfece pt. tablă
E Tijeras para chapas
CN 铁皮剪

SLIDING CARD



S55C
DROP FORGED STEEL
STAL KUTA NA ZMNO
HRC 55-60
HIGH FREQUENCY HARDENING
HARTOWANIE IMPULSOWE



| YATO | L (mm) | cutting length (mm) | cutting capacities (mm) | | | | |
|---------|--------|---------------------|-------------------------|-------------------|------------------|---------------------|------|
| | | | copper | cold-rolled steel | hard steel HRC35 | stainless steel 304 | |
| YT-1963 | 200 | 40 | 1.5 | 1.0 | 0.6 | 0.6 | 6/36 |
| YT-1964 | 250 | 60 | 1.8 | 1.2 | 0.8 | 0.8 | 6/24 |
| YT-1965 | 300 | 75 | 2.0 | 1.4 | 0.8 | 0.8 | 6/12 |

GB Heavy duty cable cutter
D Schwere Drahtschere
PL Wzmocnione nożyce do cięcia przewodów
RUS Кабелерезы
CZ Elektrické upichováky
H Kábelvágó
RO Patent tăietor pt. electric
E Tijeras para cables
CN 电缆剪

SLIDING CARD



240 mm
CrV 50
DROP FORGED STEEL
STAL KUTA NA ZMNO
HRC 55-60



- application: for copper and aluminium electric cables
- przeznaczenie: do cięcia miedzianych i aluminiowych kabli

| YATO | L (mm) | max. Ø (mm) | |
|---------|--------|-------------|------|
| YT-1969 | 240 | 9 | 6/48 |

GB Tin snips
D Blechscher
PL Nożyce do cięcia blachy
RUS Ножницы по металлу
CZ Nůžky na plech
H Lemezvágó olló
RO Foarfece pt. tablă
E Tijeras para chapas
CN 铁皮剪

SLIDING CARD



S55C
DROP FORGED STEEL
STAL KUTA NA ZMNO
HRC 55-60
HIGH FREQUENCY HARDENING
HARTOWANIE IMPULSOWE



| YATO | L (mm) | cutting length (mm) | cutting capacities (mm) | | | | |
|---------|--------|---------------------|-------------------------|-------------------|------------------|---------------------|------|
| | | | copper | cold-rolled steel | hard steel HRC35 | stainless steel 304 | |
| YT-1970 | 260 | 42 | 2.0 | 1.4 | 1.0 | 1.0 | 6/36 |

GB Heavy duty cable cutter
D Schwere Drahtschere
PL Wzmocnione nożyce do cięcia przewodów
RUS Кабелерезы
CZ Elektrické upichováky
H Kábelvágó
RO Patent tăietor pt. electric
E Tijeras para cables
CN 电缆剪

SLIDING CARD



230 mm
HRC 58-61
CrMo

Lever for increase cutting power
Ideal for copper and aluminium electric cables



GB Tin snips
D Blechscher
PL Nożyce do cięcia blachy
RUS Ножницы по металлу
CZ Nůžky na plech
H Lemezvágó olló
RO Foarfece pt. tablă
E Tijeras para chapas
CN 铁皮剪

SLIDING CARD

SLIDING CARD



S55C
DROP FORGED STEEL
STAL KUTA NA ZMNO
HRC 55-60
HIGH FREQUENCY HARDENING
HARTOWANIE IMPULSOWE



COLOR BOX

6 PCS



| YATO | L (mm) | cutting length (mm) | cutting capacities (mm) | | | | PCS packing | |
|---------|--------|---------------------|-------------------------|-------------------|------------------|---------------------|-------------|----|
| | | | copper | cold-rolled steel | hard steel HRC35 | stainless steel 304 | | |
| YT-1971 | 200 | 40 | 1.5 | 1.0 | 0.6 | 0.6 | 6 | 36 |
| YT-1972 | 260 | 53 | 1.8 | 1.2 | 0.8 | 0.8 | 6 | 36 |
| YT-1973 | 310 | 62 | 2.0 | 1.4 | 0.8 | 0.8 | 6 | 12 |

| YATO | L (mm) | max. Ø (mm) | |
|---------|--------|-------------|------|
| YT-1933 | 230 | 9 | 6/36 |

- GB Tin snips
- D Blechscherer
- PL Nożyce do cięcia blachy
- RUS Ножницы по металлу
- CZ Nůžky na plech
- H Lemezvágó olló
- RO Foarfece pt. tablă
- E Tijeras para chapas
- CN 铁皮剪

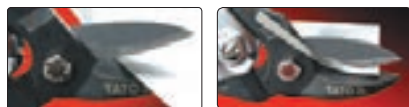

SLIDING CARD



HRC 60-62 **DIN 6438** **CrMo**

INCREASED CUTTING POWER
ZWIĘKSZONA SIŁA CIĘCIA



LEFT CUT
CIĘCIE LEWE

| YATO | L (mm) | cutting length (mm) | cutting capacities (mm) | | | | 6/36 |
|---------|--------|---------------------|-------------------------|-------------------|------------------|---------------------|------|
| | | | copper | cold-rolled steel | hard steel HRC35 | stainless steel 304 | |
| YT-1910 | 260 | 35 | 1.80 | 1.50 | 1.00 | 0.90 | 6/36 |



RIGHT CUT
CIĘCIE PRAWO



STRAIGHT CUT
CIĘCIE PROSTE

| YATO | L (mm) | cutting length (mm) | cutting capacities (mm) | | | | 6/36 |
|---------|--------|---------------------|-------------------------|-------------------|------------------|---------------------|------|
| | | | copper | cold-rolled steel | hard steel HRC35 | stainless steel 304 | |
| YT-1911 | 260 | 35 | 1.80 | 1.50 | 1.00 | 0.90 | 6/36 |

| YATO | L (mm) | cutting length (mm) | cutting capacities (mm) | | | | 6/36 |
|---------|--------|---------------------|-------------------------|-------------------|------------------|---------------------|------|
| | | | copper | cold-rolled steel | hard steel HRC35 | stainless steel 304 | |
| YT-1912 | 260 | 35 | 1.80 | 1.50 | 1.00 | 0.90 | 6/36 |



LEFT CUT
CIĘCIE LEWE



RIGHT CUT
CIĘCIE PRAWO

| YATO | L (mm) | cutting length (mm) | cutting capacities (mm) | | | | 6/36 |
|---------|--------|---------------------|-------------------------|-------------------|------------------|---------------------|------|
| | | | copper | cold-rolled steel | hard steel HRC35 | stainless steel 304 | |
| YT-1915 | 235 | 30 | 1.50 | 1.20 | 1.00 | 0.70 | 6/36 |

| YATO | L (mm) | cutting length (mm) | cutting capacities (mm) | | | | 6/36 |
|---------|--------|---------------------|-------------------------|-------------------|------------------|---------------------|------|
| | | | copper | cold-rolled steel | hard steel HRC35 | stainless steel 304 | |
| YT-1916 | 235 | 30 | 1.50 | 1.20 | 1.00 | 0.70 | 6/36 |



LEFT CUT
CIĘCIE LEWE



RIGHT CUT
CIĘCIE PRAWO

| YATO | L (mm) | cutting length (mm) | cutting capacities (mm) | | | | 6/36 |
|---------|--------|---------------------|-------------------------|-------------------|------------------|---------------------|------|
| | | | copper | cold-rolled steel | hard steel HRC35 | stainless steel 304 | |
| YT-1918 | 260 | 32 | 1.80 | 1.50 | 1.00 | 0.90 | 6/36 |

| YATO | L (mm) | cutting length (mm) | cutting capacities (mm) | | | | 6/36 |
|---------|--------|---------------------|-------------------------|-------------------|------------------|---------------------|------|
| | | | copper | cold-rolled steel | hard steel HRC35 | stainless steel 304 | |
| YT-1919 | 260 | 32 | 1.80 | 1.50 | 1.00 | 0.90 | 6/36 |



STRAIGHT CUT
CIĘCIE PROSTE



STRAIGHT CUT
CIĘCIE PROSTE

| YATO | L (mm) | cutting length (mm) | cutting capacities (mm) | | | | 6/36 |
|---------|--------|---------------------|-------------------------|-------------------|------------------|---------------------|------|
| | | | copper | cold-rolled steel | hard steel HRC35 | stainless steel 304 | |
| YT-1922 | 290 | 75 | 1.10 | 0.94 | 0.70 | 0.53 | 6/36 |

| YATO | L (mm) | cutting length (mm) | cutting capacities (mm) | | | | 6/36 |
|---------|--------|---------------------|-------------------------|-------------------|------------------|---------------------|------|
| | | | copper | cold-rolled steel | hard steel HRC35 | stainless steel 304 | |
| YT-1923 | 230 | 25 | 2.00 | 1.60 | 1.20 | 1.20 | 6/36 |

- GB Tin snips
- H Lemezvágó olló
- D Blechscherer
- RO Foarfece pt. tablă
- PL Nożyce do cięcia blachy
- E Tijeras para chapas
- RUS Ножницы по металлу
- CN 铁皮剪
- CZ Nůžky na plech



SLIDING CARD



HRC 56-62

CrMo

INCREASED CUTTING POWER
ZWIĘKSZONA SIŁA CIĘCIA

SERRATED SIDES
ZABKOWANA KRAWĘDZ OSTRZY
HIGH FREQUENCY HARDENING
HARTOWANIE IMPULSOWE



LEFT CUT
CIĘCIE LEWE

| YATO | L (mm) | cutting length (mm) | cutting capacities (mm) | | | | 6/36 |
|---------|--------|---------------------|-------------------------|-------------------|------------------|---------------------|------|
| | | | copper | cold-rolled steel | hard steel HRC35 | stainless steel 304 | |
| YT-1960 | 250 | 40 | 2.00 | 1.50 | 1.00 | 0.80 | 6/36 |



RIGHT CUT
CIĘCIE PRAWO

| YATO | L (mm) | cutting length (mm) | cutting capacities (mm) | | | | 6/36 |
|---------|--------|---------------------|-------------------------|-------------------|------------------|---------------------|------|
| | | | copper | cold-rolled steel | hard steel HRC35 | stainless steel 304 | |
| YT-1961 | 250 | 40 | 2.00 | 1.50 | 1.00 | 0.80 | 6/36 |



STRAIGHT CUT
CIĘCIE PROSTE

| YATO | L (mm) | cutting length (mm) | cutting capacities (mm) | | | | 6/36 |
|---------|--------|---------------------|-------------------------|-------------------|------------------|---------------------|------|
| | | | copper | cold-rolled steel | hard steel HRC35 | stainless steel 304 | |
| YT-1962 | 250 | 45 | 2.00 | 1.50 | 1.00 | 0.80 | 6/36 |

GB Tin snips
D Blechscherer
PL Nożyce do cięcia blachy
RUS Ножницы по металлу
CZ Nůžky na plech

H Lemezvágó olló
RO Foarfece pt. tablă
E Tijeras para chapas
CN 铁皮剪

SLIDING
CARD



For cutting
straight and
tight curves
left or right



HRC
58-60



HRC
58-61

| YATO | L (mm) | cutting length (mm) | cutting capacities (mm) | | | | 6/36 |
|---------|--------|---------------------|-------------------------|-------------------|------------------|---------------------|------|
| | | | copper | cold-rolled steel | hard steel HRC35 | stainless steel 304 | |
| YT-1920 | 260 | 42 | 1.20 | 1.00 | 0.60 | 0.50 | 6/36 |

| YATO | L (mm) | cutting length (mm) | cutting capacities (mm) | | | | 6/36 |
|---------|--------|---------------------|-------------------------|-------------------|------------------|---------------------|------|
| | | | copper | cold-rolled steel | hard steel HRC35 | stainless steel 304 | |
| YT-1924 | 254 | 52 | 0.94 | 0.78 | 0.60 | 0.45 | 6/36 |

GB Tin snips
D Blechscherer
PL Nożyce do cięcia blachy
RUS Ножницы по металлу
CZ Nůžky na plech

H Lemezvágó olló
RO Foarfece pt. tablă
E Tijeras para chapas
CN 铁皮剪

SLIDING
CARD



DROP FORGED KUTE

HRC
58-61



LEFT
CUT
CIECIE
LEWE



RIGHT
CUT
CIECIE
PRAWO

| YATO | L (mm) | cutting length (mm) | cutting capacities (mm) | | | | 6/24 |
|---------|--------|---------------------|-------------------------|-------------------|------------------|---------------------|------|
| | | | copper | cold-rolled steel | hard steel HRC35 | stainless steel 304 | |
| YT-1900 | 260 | 30 | 0.94 | 0.78 | 0.60 | 0.45 | 6/24 |

| YATO | L (mm) | cutting length (mm) | cutting capacities (mm) | | | | 6/24 |
|---------|--------|---------------------|-------------------------|-------------------|------------------|---------------------|------|
| | | | copper | cold-rolled steel | hard steel HRC35 | stainless steel 304 | |
| YT-1901 | 260 | 30 | 0.94 | 0.78 | 0.60 | 0.45 | 6/24 |



LEFT
CUT
CIECIE
LEWE



STRAIGHT
CUT
CIECIE
PROSTE

| YATO | L (mm) | cutting length (mm) | cutting capacities (mm) | | | | 6/24 |
|---------|--------|---------------------|-------------------------|-------------------|------------------|---------------------|------|
| | | | copper | cold-rolled steel | hard steel HRC35 | stainless steel 304 | |
| YT-1902 | 300 | 50 | 0.94 | 0.78 | 0.60 | 0.45 | 6/24 |

| YATO | L (mm) | cutting length (mm) | cutting capacities (mm) | | | | 6/36 |
|---------|--------|---------------------|-------------------------|-------------------|------------------|---------------------|------|
| | | | copper | cold-rolled steel | hard steel HRC35 | stainless steel 304 | |
| YT-1925 | 225 | 52 | 0.94 | 0.78 | 0.60 | 0.45 | 6/36 |

GB Tin snips
D Blechscherer
PL Nożyce do cięcia blachy
RUS Ножницы по металлу
CZ Nůžky na plech

H Lemezvágó olló
RO Foarfece pt. tablă
E Tijeras para chapas
CN 铁皮剪

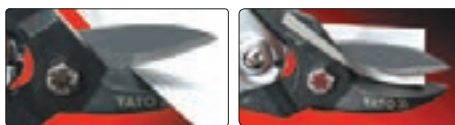

SLIDING
CARD



HRC
60-62

CrMo

90°

SEPARATED
EDGES
ZABKOWANA
KRAWĘDZ
CIĘTY



LEFT
CUT
CIECIE
LEWE



RIGHT
CUT
CIECIE
PRAWO

| YATO | L (mm) | cutting length (mm) | cutting capacities (mm) | | | | 6/36 |
|---------|--------|---------------------|-------------------------|-------------------|------------------|---------------------|------|
| | | | copper | cold-rolled steel | hard steel HRC35 | stainless steel 304 | |
| YT-1913 | 225 | 30 | 0.78 | 0.53 | 0.46 | 0.36 | 6/36 |

| YATO | L (mm) | cutting length (mm) | cutting capacities (mm) | | | | 6/36 |
|---------|--------|---------------------|-------------------------|-------------------|------------------|---------------------|------|
| | | | copper | cold-rolled steel | hard steel HRC35 | stainless steel 304 | |
| YT-1914 | 225 | 30 | 0.78 | 0.53 | 0.46 | 0.36 | 6/36 |

- GB Portable notchers
 D Schere zum Ausschneiden von Ecken
 PL Nożyce do wycinania naroży
 RUS Ножницы для наружных углов
 CZ Nůžky na vystřihování rohů
- H Sarokkivágó olló
 RO Foarfece pt. taierea colturilor
 E Tijera para esquinas
 CN 截角器

300 mm 90°

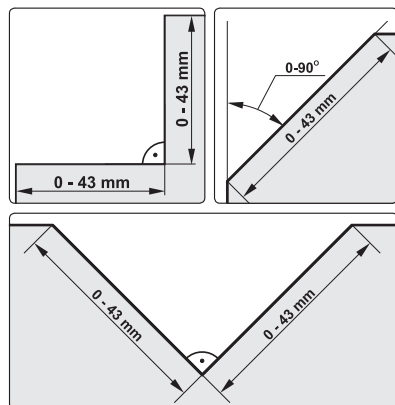

| | | |
|-------------|--------|----|
| YATO | L (mm) | |
| YT-1939 | 300 | 15 |

- GB Steel strap cutter
 D Stahlgurtblechschere
 PL Nożyce do cięcia taśmy stalowej
 RUS Ножницы для резки стальной ленты
 CZ Nůžky na plech
 H Lemezvágó olló
 RO Foarfece pt. tablă
 E Tijeras para bandejas de acero
 CN 钢带剪

HRC 58-61

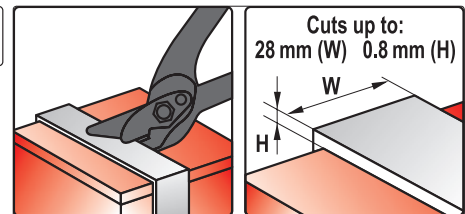

| | | | | | | | |
|-------------|--------|---------------------|-------------------------|-------------------|------------------|---------------------|------|
| YATO | L (mm) | cutting length (mm) | cutting capacities (mm) | | | | |
| | | | copper | cold-rolled steel | hard steel HRC35 | stainless steel 304 | |
| YT-1930 | 305 | 28 | - | 1.00 | 0.80 | 0.60 | 6/24 |

- GB Bolt cutter
 D Drahtschere
 PL Nożyce do prętów
 RUS Болторез
 CZ Nůžky na tyče
- H Kábelvágó olló
 RO Foarfece pt. bare
 E Cortavarillas
 CN 断线钳

HRC 56-61 CrMo



| | | | | |
|-------------|----------------|---------------|-------------------------|----|
| YATO | size / rozmiar | max. Ø (mm) | | |
| | | soft / miękki | medium / średnio twardy | |
| YT-1843 | 12" (300 mm) | 5 | 4 | 20 |
| YT-1844 | 14" (350 mm) | 7 | 5 | 10 |
| YT-1845 | 18" (450 mm) | 8 | 6 | 10 |
| YT-1846 | 24" (600 mm) | 10 | 8 | 6 |
| YT-1847 | 30" (750 mm) | 13 | 10 | 4 |
| YT-1848 | 36" (900 mm) | 16 | 12 | 3 |

- GB Bolt cutter
 D Drahtschere
 PL Nożyce do prętów
 RUS Болторез
 CZ Nůžky na tyče
 H Kábelvágó olló
 RO Foarfece pt. bare
 E Cortavarillas
 CN 断线钳

CrMo



| | | | | | | | |
|-------------|----------------|-------------|------|-------------|----------------|-------------|---|
| YATO | size / rozmiar | max. Ø (mm) | | YATO | size / rozmiar | max. Ø (mm) | |
| YT-1851 | 14" (350 mm) | 6 | 6/24 | YT-1854 | 30" (750 mm) | 12 | 6 |
| YT-1852 | 18" (450 mm) | 7 | 6/12 | YT-1855 | 36" (900 mm) | 14 | 4 |
| YT-1853 | 24" (600 mm) | 10 | 2/12 | YT-1856 | 42" (1050 mm) | 16 | 2 |

GB Hydraulic cutter
D Manueller Hydraulikschnaider
PL Ręczny obcinak hydrauliczny
RUS Ручной гидравлический резак
CZ Rucní hydraulický odřezávač
H Kézi hidraulikus betonacélvágó
RO Cuțit pt. rețezat tevi
E Cortadora hidráulica manual
CN 液壓剪



STEEL
STAL

BMC
& COLOR
SLEEVE



| YATO | cutting diameter / średnica cięcia (mm²) | L (mm) | pressure / nacisk (T) |  |
|----------|---|--------|-----------------------|---|
| YT-22870 | 4-12 | 430 | 6 | 5 |
| YT-22871 | 4-16 | 430 | 8 | 5 |
| YT-22872 | 4-20 | 515 | 13 | 4 |

GB Heads for hydraulic cutter
D Austauschmesser für Hydraulikschnaider
PL Noże wymienne do obcinaka hydraulicznego
RUS Сменные ножи для гидравлического резака

CZ Vyměnitelné nože do hydraulického odřezávače
H Cserekes a hidraulikus betonacélvágóhoz
RO Lame schimbabile pt. cuțit pt. rețezat tevi

E Cuchillas intercambiables para cortadora hidráulica
CN 液壓鉗鉗口配件

2
PCS



SLIDING
CARD



| YATO | for / dla | size / rozmiar (mm) |  |
|----------|-----------|---------------------|---|
| YT-22873 | YT-22870 | 12 | 10/100 |
| YT-22874 | YT-22871 | 16 | 10/100 |
| YT-22875 | YT-22872 | 20 | 10/100 |

GB Ratchet cable cutter
D Ratschenkabelschneider
PL Nożyce zapadkowe do kabli

RUS Кабелерез секторный
CZ Kleště na kabely, rohačka se západkou
H Racsnis kábelvágó

RO Cleste pt. taiat cablu cu clichet
E Cortacables de carraca
CN 棘輪電纜剪

COLOR BOX



Cu/Al
CABLE
KABEL

60Si2Mn

HRC 50
CUTTING BLADE
OSTRZE TNĄCE



| YATO | cutting range / max. przekrój cięcia (mm²) | L (mm) |  |
|----------|---|--------|---|
| YT-18600 | 240 | 300 | 10 |

| YATO | cutting range / max. przekrój cięcia (mm²) | L (mm) |  |
|----------|---|--------|---|
| YT-18602 | 380 | 380 | 10 |

GB Cable cutter
D Kabelschere
PL Nożyce do kabli
RUS Кабелерезы
CZ Elektrické upichováky
H Kábelvágó

RO Patent tăietor pt. electrice
E Tijeras para cables
CN 電纜剪



COLOR BOX



| YATO | cutting range / max. przekrój cięcia (mm²) | L (mm) |  |
|----------|---|--------|---|
| YT-18610 | 125 | 370 | 20 |
| YT-18611 | 250 | 580 | 10 |
| YT-18612 | 500 | 770 | 5 |

GB Multi function scissors
D Multifunktionsmesser
PL Nożyce wielofunkcyjne
RUS Ножницы многофункциональные
CZ Víceúčelové nůžky
H Többfunkciós olló
RO Foarfece multifuncțional
E Tijeras multifuncionales
CN 多用剪



65
mm

3Cr13
STAINLESS
STEEL
STAL
NERŻEWNIA

HRC
50-54

SLIDING
CARD



| YATO | L (mm) |  |
|---------|--------|---|
| YT-1976 | 65 | 12/72 |

GB Hand saw for wood
D Handsäge
PL Pila platnica do drewna
RUS Пила по дереву
CZ Pila na dřevo platnice
H Fafűrész, egyenes
RO Ferăstrău pt. lemn
E Serrucho para madera
CN 手板锯



COLOR SLEEVE

Mn 65
7T inch
1.6 mm
0.9 mm
HRC 50-54



GB Back saw
D Rucksäge
PL Pila grzbietnica
RUS Пила для стула
CZ Pila hřebenovka
H Kézifűrész
RO Ferăstrău coadă de vulpe
E Serrucho de costilla
CN 夹背锯

300 mm
Mn 65
12T inch
1.2 mm
0.8 mm
HRC 50-54



COLOR SLEEVE



| YATO | L (mm) | |
|---------|--------|-------|
| YT-3101 | 400 | 12/48 |
| YT-3102 | 450 | 10/40 |
| YT-3103 | 500 | 10/40 |

| YATO | L (mm) | |
|---------|--------|-------|
| YT-3130 | 300 | 12/60 |

PTFE COATED

| YATO | L (mm) | |
|---------|--------|-------|
| YT-3106 | 400 | 12/48 |
| YT-3107 | 450 | 10/40 |
| YT-3108 | 500 | 10/40 |

GB Compass saw
D Stichsäge
PL Pila otwornica
RUS Выкружная пила
CZ Pila otwornice

H Lyukfűrész
RO Ferăstrău coadă de șoarece
E Serrucho de punta
CN 鸡尾锯

300 mm
Mn 65
7T inch
1.6 mm
0.9 mm
HRC 50-54



COLOR SLEEVE

| YATO | L (mm) | |
|---------|--------|-------|
| YT-3133 | 300 | 12/60 |

GB Wallboard saw
D Gipsäge
PL Pila do gipsów
RUS Ножовка по гипсокартону
CZ Pila na sádro

H Gipszfűrész
RO Ferăstrău pt. ghips
E Serrucho para cartón yeso
CN 墙板锯

150 mm
Mn 65
7T inch
2.0 mm
1.5 mm
HRC 50-54



COLOR SLEEVE

| YATO | L (mm) | |
|---------|--------|-------|
| YT-3134 | 150 | 12/60 |

GB Plastic mitre box with dovetail saw
D Kunststoffschnidladen mit Sage
PL Plastikowa skrzynka uciosowa z piłą
RUS Стуло пластмассовое с пилой
CZ Přípravek na řezání úhlů s pilkou
H Gërbavóg múanyagláda hódfarkú fűrészszel
RO Pasuitor + cutie
E Guía de ingletar y sierra
CN 燕尾锯



COLOR BOX

350 mm
Mn 65
1.2 mm
0.8 mm
12T inch
HRC 50-54
ABS
300x140 x70mm



| YATO | L (mm) | |
|---------|--------|----|
| YT-3150 | 350 | 10 |

GB Bow saw
D Bùgelsäge
PL Pila kablakowa
RUS Лучковая пила
CZ Oblouková pila

H Keretes fűrész
RO Ferăstrău de curbă
E Sierra de arco
CN 两用弓锯

COLOR SLEEVE



HCS 65



FOR WOOD
DO DREWNA



2 FUNCTION

FOR WOOD AND METAL
DO DREWNA I METALU

| YATO | L (mm) | |
|---------|--------|-------|
| YT-3200 | 300 | 12/24 |

| YATO | L (mm) | |
|---------|--------|-------|
| YT-3201 | 450 | 12/24 |
| YT-3202 | 530 | |
| YT-3203 | 610 | |
| YT-3204 | 760 | |

GB Blade for dry wood
D Trockenholzsägeblatt für Handsäge
PL Brzeczot do drewna suchego
RUS Лезвие для работы по сухому дереву

CZ Pilový list na suché dřevo
H Fűrészlap száraz fához
RO Lama pt. lemn uscat
E Hoja de sierra para madera seca
CN 干木锯条

HCS
65

DRY
WOOD
DREWNO
SUCHE



COLOR SLEEVE

| YATO | L (mm) | |
|---------|--------|--------|
| YT-3220 | 300 | 50/200 |
| YT-3221 | 450 | |
| YT-3222 | 530 | |
| YT-3223 | 610 | |
| YT-3224 | 760 | |
| YT-3225 | 910 | |

GB Blade for wet wood
D Nassholzsägeblatt für Handsäge
PL Brzeczot do drewna mokrego
RUS Лезвие для работы по влажному дереву

CZ Pilový list na mokré dřevo
H Fűrészlap nedves fához
RO Lama pt. lemn verde
E Hoja de sierra para madera mojada
CN 湿木锯条

HCS
65

WET
WOOD
DREWNO
MOKRE



COLOR SLEEVE

| YATO | L (mm) | |
|---------|--------|--------|
| YT-3230 | 300 | 50/200 |
| YT-3231 | 450 | |
| YT-3232 | 530 | |
| YT-3233 | 610 | |
| YT-3234 | 760 | |

GB Hacksaw frame
D Metallbogensäge
PL Piła do metalu
RUS Пила по металлу

CZ Pilka na železo
H Fémfűrész
RO Ferăstrău
cu cadru metalic

E Sierra de metalo
CN 锯架

COLOR
SLEEVE



BI-METAL

24
TPI

FOR
METAL
DO
METALU



| YATO | L (mm) | |
|---------|--------|----|
| YT-3160 | 300 | 10 |



| YATO | L (mm) | |
|---------|--------|------|
| YT-3161 | 300 | 6/36 |



| YATO | L (mm) | |
|---------|--------|------|
| YT-3163 | 300 | 5/20 |

GB Hacksaw frame blade
D Metallsägeblatt
PL Brzeczot do metalu

RUS Полотно по металлу
CZ Pilový list na kovy
H Fémfűrész lap

RO Panza fierastrau pt. metal
E Hoja de sierra para metalo
CN 锯条

300
mm

12
mm

24
TPI



PLASTIC
HANGER

BI-METAL
M2+6150

BI-METAL
M2+Co8%

| YATO | L (mm) | W (mm) | TPI | PCS packing: | |
|---------|--------|--------|-----|-----------------|--------|
| YT-3460 | 300 | 12 | 24 | 5 | 10/200 |

| YATO | L (mm) | W (mm) | TPI | PCS packing: | |
|---------|--------|--------|-----|-----------------|--------|
| YT-3461 | 300 | 12 | 24 | 2 | 20/500 |

| YATO | L (mm) | W (mm) | TPI | PCS packing: | |
|---------|--------|--------|-----|-----------------|--------|
| YT-3462 | 300 | 12 | 24 | 2 | 20/500 |

GB Jig saw blades
D Stichsägeblätter
PL Brzeczscoty do wyrzynarki

RUS Полотно для электр. станка
CZ Pilový list do přímočaré pily
H Dekopírlap

RO Lama fierastrau pendular
E Recambio sierra de calar
CN 曲线锯条

BLISTER CARD

5 PCS

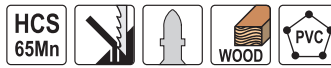

| YATO | L (mm) | working length (mm) | thickness (mm) | TPI | Box |
|---------|--------|---------------------|----------------|-----|--------|
| YT-3400 | 100 | 75 | 1.27 | 6 | 50/250 |

| YATO | L (mm) | working length (mm) | thickness (mm) | TPI | Box |
|---------|--------|---------------------|----------------|-----|--------|
| YT-3401 | 100 | 75 | 1.3 | 10 | 50/250 |

| YATO | L (mm) | working length (mm) | thickness (mm) | TPI | Box |
|---------|--------|---------------------|----------------|-----|--------|
| YT-3402 | 100 | 75 | 1.2 | 8 | 50/250 |



| YATO | L (mm) | working length (mm) | thickness (mm) | TPI | Box |
|---------|--------|---------------------|----------------|-----|--------|
| YT-3403 | 100 | 75 | 1.3 | 6 | 50/250 |

| YATO | L (mm) | working length (mm) | thickness (mm) | TPI | Box |
|---------|--------|---------------------|----------------|-----|--------|
| YT-3404 | 100 | 75 | 1.3 | 10 | 50/250 |

| YATO | L (mm) | working length (mm) | thickness (mm) | TPI | Box |
|---------|--------|---------------------|----------------|-----|--------|
| YT-3405 | 100 | 75 | 1.3 | 6 | 50/250 |



| YATO | L (mm) | working length (mm) | thickness (mm) | TPI | Box |
|---------|--------|---------------------|----------------|-----|--------|
| YT-3407 | 75 | 50 | 1.0 | 13 | 50/250 |

| YATO | L (mm) | working length (mm) | thickness (mm) | TPI | Box |
|---------|--------|---------------------|----------------|------|--------|
| YT-3408 | 115 | 90 | 1.3 | 13-8 | 50/250 |

| YATO | L (mm) | working length (mm) | thickness (mm) | TPI | Box |
|---------|--------|---------------------|----------------|-----|--------|
| YT-3409 | 115 | 90 | 1.3 | 8 | 50/250 |



| YATO | L (mm) | working length (mm) | thickness (mm) | TPI | Box |
|---------|--------|---------------------|----------------|-----|--------|
| YT-3410 | 100 | 75 | 1.4 | 6 | 50/250 |

| YATO | L (mm) | working length (mm) | thickness (mm) | TPI | Box |
|---------|--------|---------------------|----------------|-----|--------|
| YT-3411 | 100 | 75 | 1.0 | 8 | 25/250 |

| YATO | L (mm) | working length (mm) | thickness (mm) | TPI | Box |
|---------|--------|---------------------|----------------|-----|--------|
| YT-3412 | 75 | 50 | 1.0 | 21 | 25/250 |



| YATO | L (mm) | working length (mm) | thickness (mm) | TPI | Box |
|---------|--------|---------------------|----------------|-----|--------|
| YT-3413 | 75 | 50 | 1.0 | 12 | 25/250 |

| YATO | L (mm) | working length (mm) | thickness (mm) | TPI | Box |
|---------|--------|---------------------|----------------|-----|--------|
| YT-3414 | 75 | 50 | 1.0 | 32 | 25/250 |

| YATO | L (mm) | working length (mm) | thickness (mm) | TPI | Box |
|---------|--------|---------------------|----------------|-------|--------|
| YT-3415 | 100 | 75 | 1.0 | 24-10 | 25/250 |

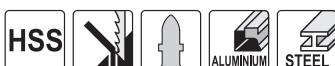

| YATO | L (mm) | working length (mm) | thickness (mm) | TPI | Box |
|---------|--------|---------------------|----------------|-----|--------|
| YT-3416 | 130 | 106 | 1.0 | 21 | 25/250 |

| YATO | L (mm) | working length (mm) | thickness (mm) | TPI | Box |
|---------|--------|---------------------|----------------|------|--------|
| YT-3417 | 130 | 106 | 1.27 | 10-5 | 25/250 |

| YATO | L (mm) | working length (mm) | thickness (mm) | TPI | Box |
|---------|--------|---------------------|----------------|-----|--------|
| YT-3421 | 75 | 50 | 1.2 | - | 25/250 |



| YATO | L (mm) | working length (mm) | thickness (mm) | TPI | Box |
|---------|--------|---------------------|----------------|-----|--------|
| YT-3430 | 91.5 | 74.5 | 1.3 | 10 | 25/250 |

| YATO | L (mm) | working length (mm) | thickness (mm) | TPI | Box |
|---------|--------|---------------------|----------------|-----|--------|
| YT-3431 | 91.5 | 74.5 | 1.2 | 8 | 25/250 |

| YATO | L (mm) | working length (mm) | thickness (mm) | TPI | Box |
|---------|--------|---------------------|----------------|-----|--------|
| YT-3432 | 91.5 | 74.5 | 1.3 | 6 | 25/250 |



| YATO | L (mm) | working length (mm) | thickness (mm) | TPI | Box |
|---------|--------|---------------------|----------------|-----|--------|
| YT-3433 | 91.5 | 74.5 | 1.3 | 10 | 25/250 |

| YATO | L (mm) | working length (mm) | thickness (mm) | TPI | Box |
|---------|--------|---------------------|----------------|------|--------|
| YT-3434 | 108 | 91 | 1.3 | 12-8 | 25/250 |

| YATO | L (mm) | working length (mm) | thickness (mm) | TPI | Box |
|---------|--------|---------------------|----------------|-----|--------|
| YT-3435 | 100 | 83 | 1.27 | 6 | 25/250 |

GB Jig saw blades
D Stichsägeblätter
PL Brzeszczyoty do wyrzynarki

RUS Полотно для электр. станка
CZ Pílový list do přímočaré pily
H Dekopírlap

RO Lama fierastrau pendular
E Recambio sierra de calar
CN 曲线锯条

BLISTER
CARD



5
PCS



| YATO | L (mm) | working length (mm) | thickness (mm) | TPI | Box |
|---------|--------|---------------------|----------------|-----|--------|
| YT-3440 | 70 | 53 | 1.0 | 21 | 25/250 |

| YATO | L (mm) | working length (mm) | thickness (mm) | TPI | Box |
|---------|--------|---------------------|----------------|-----|--------|
| YT-3441 | 70 | 53 | 1.0 | 12 | 25/250 |

| YATO | L (mm) | working length (mm) | thickness (mm) | TPI | Box |
|---------|--------|---------------------|----------------|-----|--------|
| YT-3442 | 70 | 53 | 1.0 | 36 | 25/250 |

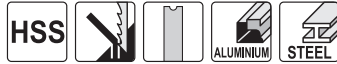

| YATO | L (mm) | working length (mm) | thickness (mm) | TPI | Box |
|---------|--------|---------------------|----------------|-------|--------|
| YT-3443 | 91.5 | 74.5 | 1.0 | 21-16 | 25/250 |

| YATO | L (mm) | working length (mm) | thickness (mm) | TPI | Box |
|---------|--------|---------------------|----------------|------|--------|
| YT-3444 | 127 | 110 | 1.2 | 10-5 | 25/250 |



| YATO | L (mm) | working length (mm) | thickness (mm) | TPI | Box |
|---------|--------|---------------------|----------------|-----|--------|
| YT-3445 | 100 | 75 | 1.3 | 10 | 25/250 |
| | 100 | 75 | 1.3 | 6 | |
| | 100 | 75 | 1.27 | 10 | |
| | 75 | 50 | 1.0 | 32 | |
| | 75 | 57 | 1.0 | 12 | |

GB Steel wire brush
D Stahldrahtbürste
PL Szczotka druciana

RUS Щетка стальная
CZ Drátěný kartáč
H Drótkefe

RO Perie de sârmă
E Cepillo de acero
CN 钢丝刷

ZINC
PLATED
WIRES



| YATO | rows / rzędy | Box |
|---------|--------------|--------|
| YT-6353 | 3 | 12/120 |
| YT-6354 | 4 | 12/120 |
| YT-6355 | 5 | 12/120 |
| YT-6356 | 6 | 12/120 |

| YATO | rows / rzędy | Box |
|---------|--------------|-------|
| YT-6357 | 3 | 12/72 |
| YT-6358 | 4 | 12/72 |
| YT-6359 | 5 | 12/72 |
| YT-6360 | 6 | 12/72 |

GB Steel wire brush
D Stahldrahtbürste
PL Szczotka druciana

RUS Щетка стальная
CZ Drátěný kartáč
H Drótkefe

RO Perie de sârmă
E Cepillo de acero
CN 钢丝刷

STEEL
STAL



| YATO | rows / rzędy | L (mm) | Box |
|---------|--------------|--------|-------|
| YT-6328 | 3 | 35x100 | 12/72 |

| YATO | rows / rzędy | L (mm) | Box |
|---------|--------------|--------|-------|
| YT-6329 | 3 | 35x100 | 12/72 |

GB Steel wire brush
 D Stahldrahtbürste
 PL Szczotka druciana

RUS Щетка стальная
 CZ Drátěný kartáč
 H Drótkefe

RO Perie de sârmă
 E Cepillo de acero
 CN 钢丝刷

TIED
 ON CARD



STEEL
 STAL

| YATO | rows / rzędy | L (mm) | |
|---------|--------------|--------|-------|
| YT-6330 | 3 | 340 | 12/72 |



STEEL
 STAL

| YATO | rows / rzędy | L (mm) | |
|---------|--------------|--------|-------|
| YT-6331 | 3 | 340 | 12/72 |



STEEL
 STAL

| YATO | rows / rzędy | L (mm) | |
|---------|--------------|--------|-------|
| YT-6332 | 4 | 260 | 12/72 |



STEEL
 STAL

| YATO | rows / rzędy | L (mm) | |
|---------|--------------|--------|-------|
| YT-6333 | 4 | 290 | 12/72 |



STEEL
 STAL

| YATO | rows / rzędy | L (mm) | |
|---------|--------------|--------|-------|
| YT-6334 | 6 | 180x65 | 12/60 |



STAINLESS
 STEEL
 STAL
 NERDZEWNIA

| YATO | rows / rzędy | L (mm) | |
|---------|--------------|--------|-------|
| YT-6335 | 3 | 340 | 12/72 |



STAINLESS
 STEEL
 STAL
 NERDZEWNIA

| YATO | rows / rzędy | L (mm) | |
|---------|--------------|--------|-------|
| YT-6336 | 3 | 340 | 12/72 |



STAINLESS
 STEEL
 STAL
 NERDZEWNIA

| YATO | rows / rzędy | L (mm) | |
|---------|--------------|--------|--------|
| YT-6337 | 3 | 180 | 24/144 |



STAINLESS
 STEEL
 STAL
 NERDZEWNIA

| YATO | rows / rzędy | L (mm) | |
|---------|--------------|--------|-------|
| YT-6338 | 4 | 260 | 12/72 |



STAINLESS
 STEEL
 STAL
 NERDZEWNIA

| YATO | rows / rzędy | L (mm) | |
|---------|--------------|--------|-------|
| YT-6339 | 4 | 290 | 12/72 |



STAINLESS
 STEEL
 STAL
 NERDZEWNIA

| YATO | rows / rzędy | L (mm) | |
|---------|--------------|--------|--------|
| YT-6340 | 5 | 180 | 24/120 |



BRASS
 MOSIĄDZ

| YATO | rows / rzędy | L (mm) | |
|---------|--------------|--------|-------|
| YT-6341 | 3 | 340 | 12/72 |

GB Steel wire brush
D Stahldrahtbürste
PL Szczotka druciana
RUS Щетка стальная
CZ Drátěný kartáč
H Drótkefe
RO Perie de sârmă
E Cepillo de acero
CN 钢丝刷



BRASS
MOSIADZ

| YATO  | rows / rzędy | L (mm) |  |
|--|--------------|--------|---|
| YT-6342 | 3 | 340 | 12/72 |



BRASS
MOSIADZ

| YATO  | rows / rzędy | L (mm) |  |
|--|--------------|--------|---|
| YT-6343 | 3 | 180 | 24/144 |



BRASS
MOSIADZ

| YATO  | rows / rzędy | L (mm) |  |
|--|--------------|--------|---|
| YT-6344 | 4 | 260 | 12/72 |



BRASS
MOSIADZ

| YATO  | rows / rzędy | L (mm) |  |
|--|--------------|--------|---|
| YT-6345 | 4 | 290 | 12/72 |



BRASS
MOSIADZ

| YATO  | rows / rzędy | L (mm) |  |
|--|--------------|--------|---|
| YT-6346 | 5 | 180 | 24/120 |



BRASS
MOSIADZ

| YATO  | rows / rzędy | L (mm) |  |
|--|--------------|--------|---|
| YT-6347 | 6 | 180x65 | 12/60 |



NYLON

| YATO  | rows / rzędy | L (mm) |  |
|--|--------------|--------|---|
| YT-6348 | 4 | 290 | 12/72 |



NYLON

| YATO  | rows / rzędy | L (mm) |  |
|--|--------------|--------|---|
| YT-6349 | 5 | 180 | 24/120 |



NYLON

| YATO  | rows / rzędy | L (mm) |  |
|--|--------------|--------|---|
| YT-6350 | 6 | 180x65 | 12/60 |

GB Plastic handle wire brush set
D Bürstensatz
PL Komplet szczotek drucianych
RUS Щетки - набор
CZ Drátěný kartáče
H Kefekészlet
RO Perii
E Juego de 3 cepillos
CN 钢丝刷组套

3
PCS
STAINLESS
STEEL
STAL
NERDZEWA
BRASS
MOSIADZ
NYLON



SLIDING
CARD



| YATO  | rows / rzędy | L (mm) |  |
|--|--------------|--------|---|
| YT-6351 | 3 | 180 | 24/144 |

GB Cup brush with shaft
 D Stahldraht-Topfbürste
 PL Szczotka czolowa z trzpieniem
 RUS Щетка "чашка" со стержнем
 CZ Čelní kartáč drátěný se stopkou
 H Homlok drótkefe, nyéllal
 RO Perie frontală pt. bormasina
 E Cepillo de copa con mandril
 CN 钢丝轮

SLIDING CARD



INOX



| YATO | Ø (mm) | R.P.M.max. | Box |
|---------|--------|------------|-------|
| YT-4750 | 75 | 4500 | 12/96 |

| YATO | Ø (mm) | R.P.M.max. | Box |
|---------|--------|------------|-------|
| YT-4751 | 75 | 4500 | 12/96 |

| YATO | Ø (mm) | R.P.M.max. | Box |
|---------|--------|------------|-------|
| YT-4752 | 75 | 6000 | 12/72 |

GB Cup brush with shaft set
 D Drahtbürste mit Einspannschaft
 PL Szczotki druciane z trzpieniem
 RUS Щетки проволочные со стержнем
 CZ Drátěný kartáč se stopkou
 H Drótkefe, csapos
 RO Perii de sârmă cu tijă
 E Cepillos de alambre con espiga
 CN 三件钢丝组套



SLIDING CARD



| YATO | Ø (mm) | R.P.M.max. | Box |
|---------|--------|------------|-------|
| YT-4755 | 20 | 6000 | 12/60 |
| | 50 | 7500 | |
| | 50 | 4500 | |

GB Circular brush with shaft
 D Stahldraht-Scheibenbürste
 PL Szczotka tarczowa z trzpieniem
 RUS Щетка круговая со стержнем
 CZ Okružní kartáč drátěný se stopkou
 H Tarcás drótkefe, nyéllal
 RO Perie rotundă pt. bormasina
 E Cepillo redondo
 CN 钢丝轮

SLIDING CARD



INOX



| YATO | Ø (mm) | R.P.M.max. | Box |
|---------|--------|------------|-------|
| YT-4757 | 100 | 4500 | 12/96 |

| YATO | Ø (mm) | R.P.M.max. | Box |
|---------|--------|------------|-------|
| YT-4758 | 100 | 4500 | 12/96 |

| YATO | Ø (mm) | R.P.M.max. | Box |
|---------|--------|------------|--------|
| YT-4759 | 75 | 20000 | 10/100 |

GB Circular brush
 D Stahldraht-Scheibenbürste
 PL Szczotka tarczowa z gwintem
 RUS Щетка круговая
 CZ Okružní kartáč drátěný
 H Tarcás drótkefe
 RO Perie rotundă pt. bormasina
 E Cepillo redondo
 CN 钢丝轮

COLOR BOX



M14



INOX



| YATO | Ø (mm) | R.P.M.max. | Box |
|---------|--------|------------|------|
| YT-4761 | 100 | 12500 | 8/64 |

| YATO | Ø (mm) | R.P.M.max. | Box |
|---------|--------|------------|------|
| YT-4763 | 100 | 12500 | 8/64 |

| YATO | Ø (mm) | R.P.M.max. | Box |
|---------|--------|------------|------|
| YT-4764 | 125 | 10000 | 8/48 |

GB Cup brush
 D Stahldraht-Topfbürste
 PL Szczotka czolowa z gwintem
 RUS Щетка "чашка"
 CZ Čelní kartáč drátěný
 H Homlok drótkefe
 RO Perie frontală
 E Cepillo de copa
 CN 钢丝轮

COLOR BOX



M14



INOX



| YATO | Ø (mm) | R.P.M.max. | Box |
|---------|--------|------------|------|
| YT-4766 | 100 | 8500 | 4/32 |

| YATO | Ø (mm) | R.P.M.max. | Box |
|---------|--------|------------|-------|
| YT-4767 | 60 | 12500 | 10/80 |

| YATO | Ø (mm) | R.P.M.max. | Box |
|---------|--------|------------|------|
| YT-4768 | 75 | 11000 | 6/36 |

| YATO | Ø (mm) | R.P.M.max. | Box |
|---------|--------|------------|------|
| YT-4769 | 100 | 8500 | 4/16 |

GB Electrician's knife
D Montagemesser
PL Nóż składany monterski
RUS Нож складной
CZ Montážní nůž

H Szerelőkés
RO Cuțit pt. decablat
E Cuchillo de montaje
CN 电工刀

SLIDING CARD





3CR13



HRC 42-48



85 mm 200 mm

75 mm 190 mm

YATO  
YT-7600 6/96

YATO  
YT-7601 6/96

GB Folding knife with bits
D Klappmesser
PL Nóż składany z bitami
RUS Нож складной
CZ Kapesní nůž

H Zsebkés
RO Briceag
E Navaja
CN 旋具头折叠刀

BLISTER CARD



STAINLESS STEEL STAL NERDZEWNIA

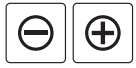

AI



|| 3, 4 mm; ○ 3, 4 mm;
⊕ PH1, PH2; ⊗ T10, T20

YATO  
YT-76031 4/40

GB Folding knife
D Klappmesser
PL Nóż składany

RUS Нож складной
CZ Kapesní nůž

H Zsebkés
RO Briceag
E Navaja
CN 折叠刀

SLIDING CARD



STAINLESS STEEL BLADE OSTRZE ZE STALI NERDZEWNIEJ



YATO  
YT-76050 12/72

AI



YATO  
YT-76051 12/120



YATO  
YT-76052 12/120

GB Multi knife
 D Klappmesser
 PL Nóż wielofunkcyjny
 RUS Нож складной
 CZ Kapesní nůž
 H Zsebkés
 RO Briceag
 E Navaja
 CN 多功能折叠刀



7
PCS
 STAINLESS
STEEL
STAL
NIEBZEWNA
 AI



SLIDING
CARD

YATO
YT-76030

12/96

GB Multi knife
 D Klappmesser
 PL Narzędzie
 wielofunkcyjne

RUS Нож складной
 CZ Kapesní nůž

RO Briceag
 E Navaja
 CN 多功能折叠刀

BLISTER
CARD



9
PCS

STAINLESS
STEEL
STAL
NIEBZEWNA



AI

AI

YATO
YT-76040

10/100

YATO
YT-76041

12/48



AI

YATO
YT-76042

12/48

YATO
YT-76043

6/36

GB Cutter knife
D Universalmesser
PL Nożyk z ostrzem trapezowym

RUS Ножи универсальные
CZ Univerzální nůž
H Univerzális kés

RO Cuțit universal
E Cutter con filo trapezoidal
CN 实用刀



 **SK5**

TRY ME
DOUBLE
BLISTER



SK2



 **x5**

LOCK

**ZINC
ALLOY
TPR**

SLIDING
CARD

| | | |
|-------------|--|---|
| YATO |  (mm) |  |
| YT-7520 | 61x33x0.5 | 6/48 |

| | | |
|-------------|--|---|
| YATO |  (mm) |  |
| YT-7523 | 61x33x0.5 | 6/48 |

GB Cutter knife
D Universalmesser
PL Nożyk z ostrzem trapezowym

RUS Ножи универсальные
CZ Univerzální nůž
H Univerzális kés

RO Cuțit universal
E Cutter con filo trapezoidal
CN 实用刀



 **SK5**



DOUBLE
BLISTER

DOUBLE
BLISTER

| | | |
|-------------|--|---|
| YATO |  (mm) |  |
| YT-7532 | 61x33x0.5 | 12/72 |

| | | |
|-------------|--|---|
| YATO |  (mm) |  |
| YT-7534 | 61x33x0.5 | 12/72 |

GB Utility knife
D Universalmesser
PL Nożyk z łamanym ostrzem
RUS Нож универсальный
CZ Nůž na tapety

H Tapétaolló
RO Cuțitaș pt. tapet
E Cuchillo para papel de empapelar
CN 美工刀



SLIDING
CARD



SK5



 **x4**

 **x5** **LOCK**



| | | |
|-------------|--|---|
| YATO |  (mm) |  |
| YT-7500 | 9x0.4 | 24/240 |



| | | |
|-------------|--|---|
| YATO |  (mm) |  |
| YT-7501 | 18x0.4 | 12/120 |



 **x3** **AL
HANDLE**

 **x3** **LOCK**

| | | |
|-------------|--|---|
| YATO |  (mm) |  |
| YT-7571 | 9x0.4 | 20/80 |
| YT-7581 | 18x0.4 | 20/80 |

| | | |
|-------------|--|---|
| YATO |  (mm) |  |
| YT-7510 | 25x0.7 | 6/48 |

GB Utility knife
 D Universalmesser
 PL Nożyk z łamanym ostrzem
 RUS Нож универсальный

CZ Nůž na tapety
 H Tapétaolló
 RO Cuțitaș pt. tapet

E Cuchillo para papel de empapelar
 CN 美工刀

SLIDING CARD



SK2



ABS

| YATO | (mm) | |
|---------|--------|--------|
| YT-7511 | 9x0.4 | 24/288 |
| YT-7512 | 18x0.5 | 12/96 |

| YATO | (mm) | |
|---------|--------|--------|
| YT-7504 | 9x0.4 | 24/240 |
| YT-7505 | 18x0.5 | 24/240 |



LOCK ABS TPR

LOCK ABS TPR

| YATO | (mm) | |
|---------|--------|--------|
| YT-7506 | 9x0.4 | 24/240 |
| YT-7507 | 18x0.5 | 12/144 |

| YATO | (mm) | |
|---------|--------|--------|
| YT-7502 | 9x0.4 | 24/240 |
| YT-7503 | 18x0.5 | 12/144 |



LOCK ABS TPR

| YATO | (mm) | |
|---------|-------|--------|
| YT-7508 | 9x0.4 | 12/144 |

10

GB Spare blades
 D Abbrechklingen
 PL Ostrza zapasowe
 RUS Лезвия для универсальных ножей

CZ Lomené ostří náhradní
 H Törhető tartalékpenge
 RO Lame de rezervă rupte
 E Filo partido de recambio
 CN 美工刀刀片

PLASTIC BOX & SLIDING CARD



10 PCS

SK5



| YATO | (mm) | |
|---------|--------|------|
| YT-7530 | 25x0.7 | 6/48 |



| YATO | (mm) | |
|---------|-----------|--------|
| YT-7531 | 61x33x0.5 | 24/144 |



| YATO | (mm) | |
|---------|--------|--------|
| YT-7528 | 9x0.4 | 24/144 |
| YT-7529 | 18x0.5 | 24/144 |

GB Spare blades
 D Abbrechklingen
 PL Ostrza zapasowe
 RUS Лезвия для универсальных ножей

CZ Lomené ostří náhradní
 H Törhető tartalékpenge
 RO Lame de rezervă rupte
 E Filo partido de recambio
 CN 美工刀刀片

PLASTIC BOX & SLIDING CARD

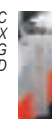

10 PCS

SK2



| YATO | (mm) | |
|---------|--------|--------|
| YT-7524 | 9x0.4 | 24/240 |
| YT-7525 | 18x0.5 | 24/144 |



| YATO | (mm) | |
|---------|-----------|--------|
| YT-7527 | 61x33x0.5 | 24/144 |

GB Electrician scissors
 D Elektrische Schere
 PL Nożyczki dla elektryków
 RUS Ножницы универсальные
 CZ Elektrické nůžky

H Univerzális olló
 RO Foarfecă - electrician
 E Tijeras eléctricos
 CN 电工剪

140 mm

STAINLESS STEEL STAL NIERDZEWNA

HRC 52-56



SLIDING CARD

| YATO | L (mm) | |
|---------|--------|--------|
| YT-1974 | 140 | 12/120 |

GB Scissors
 D Haushaltsschere
 PL Nożyczki
 RUS Ножницы
 CZ Nůžky

H Olló
 RO Foarfecă
 E Tijeras
 CN 剪刀

STAINLESS STEEL BLADE OSTRZE ZE STALI NIERDZEWNEJ



SLIDING CARD

| YATO | L (mm) | |
|----------|--------|--------|
| YT-19763 | 170 | 12/120 |
| YT-19764 | 190 | 12/120 |
| YT-19765 | 215 | 12/120 |
| YT-19766 | 245 | 12/120 |
| YT-19767 | 300 | 12/120 |

GB Glass oil cutter
D Glasschneider
PL Nóż olejowy do szkła
RUS Стеклопоз масляный

CZ Řezák na sklo
H Olajkés üveghez
RO Diamant pt. taiat stricla cu ulei

E Cuchillo de aceite para cristalinación
CN 玻璃割刀

SLIDING CARD



YD05
TUNGSTEN CARBIDE BY
OPTICIZ & WĘGLIK
WOLFRAMU
HRA 92.5-93



| | | |
|-------------|--------|-------|
| YATO | L (mm) | |
| YT-7560 | 177 | 6/120 |

| | | |
|-------------|--------|-------|
| YATO | L (mm) | |
| YT-7561 | 178 | 6/120 |

GB Scriber for glass, ceramics and metal
D Reißnadel für Glas, Keramik und Metall
PL Rysik do szkła, ceramiki i metalu

RUS Штихель для стекла, керамика и металла
CZ Rýsovací jehla na sklo, keramiku a kov
H Karctű üveghez, kerámiához és fémhez

RO Ac de trasat pt. sticlă, ceramică și metal
E Trazador para vidrio, cerámica y metal
CN 划线器

SLIDING CARD



140 mm
YG6X
TUNGSTEN CARBIDE BY
OPTICIZ & WĘGLIK
WOLFRAMU



| | | |
|-------------|--------|-------|
| YATO | L (mm) | |
| YT-3740 | 140 | 6/240 |

GB Double edge trimmer
D Kantentrimmer
PL Dwustronny nóż do odcinania oklein

CZ Orezávací nuž na hrany lamina
H Kétélú vágó
RO Rindea pt. finisaje
E Cuchillo de doble filo para cortar chapas de madera
CN 双边刨子



13-25 mm

ONE SIDE CUTTING BOTH SIDE CUTTING

SK5

SLIDING CARD



| | |
|-------------|------|
| YATO | |
| YT-5710 | 6/48 |

GB Profile gauge
D Profilmuster
PL Wzornik profili

RUS Шаблон профилей
CZ Profilová šablona
H Profilsablon

RO Șablon profile
E Plantilla de perfiles
CN 轮廓仪

SLIDING CARD



44 mm

1.5 mm



| | | |
|-------------|--------|-------|
| YATO | L (mm) | |
| YT-3735 | 125 | 24/72 |

| | | |
|-------------|--------|-------|
| YATO | L (mm) | |
| YT-3736 | 260 | 10/40 |

GB Punch set
D Lederlocherst
PL Przebijaki do skóry
RUS Набор пробойников для кожи
CZ Sada průbojníků na kůži
H Bőrlukasztó készlet
RO Set preducele
E Juego de perforar en piel
CN 冲孔器组套



POUCH & COLOR BOX



9 PCS

15 PCS

| | | |
|-------------|--|----|
| YATO | size / rozmiar | |
| YT-3590 | 2.5; 3.0; 4.0; 5.0; 6.0; 7.0; 8.0; 9.0; 10.0 | 50 |

| | | |
|-------------|---|----|
| YATO | size / rozmiar | |
| YT-3591 | 2.0; 2.5; 3.2; 4.0; 4.8; 5.5; 6.4; 8.0; 9.5; 11.1; 12.7; 14.0; 15.8; 19.0; 22.0 | 10 |

GB PVC pipe cutter
 D PVC Rohrschneider
 PL Obcinak do rur PCV
 RUS Труборез для ПВХ труб
 CZ Rezač PVC trubek

H Csővágó olló PVC csövekhez
 RO Clește pt. tăiat țevi din PVC
 E Cortatubos PVC
 CN PVC 管子割刀

SLIDING
CARD



AUTOMATIC

| | | |
|-------------|-------------|------|
| YATO | max. Ø (mm) | |
| YT-2230 | 35 | 6/48 |

| | | |
|-------------|-------------|------|
| YATO | max. Ø (mm) | |
| YT-2231 | 42 | 6/48 |



Al

Al

| | | |
|-------------|-------------|------|
| YATO | max. Ø (mm) | |
| YT-2228 | 51 | 6/24 |

| | | |
|-------------|-------------|------|
| YATO | max. Ø (mm) | |
| YT-2229 | 64 | 6/24 |

GB Pipe cutter
 D Rohrschneider
 PL Obcinak do rur
 RUS Труборез для труб
 CZ Rezač trubek
 H Csővágó olló csövekhez
 RO Clește pt. tăiat țevi
 E Cortatubos
 CN 管子割刀

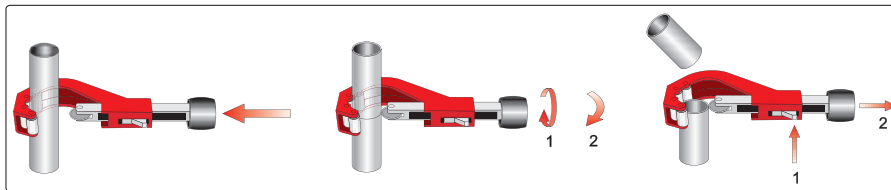

COLOR BOX



10



Ø 3/8"-1-5/8"
 Ø 10-40 mm

WITH DEBURRER
Z GRATOWNIKIEM
 Ø 1/4"-7/4"
 Ø 6-45 mm

| | | |
|-------------|------------------------|----|
| YATO | Ø | |
| YT-2232 | 3/8"-1-5/8" (10-40 mm) | 20 |

| | | |
|-------------|---------------------|----|
| YATO | Ø | |
| YT-2233 | 1/4"-7/4" (6-45 mm) | 25 |



QUICK-ADJUSTMENT
SZYBKONASTAWNY
 Ø 1/2"-5/2"
 Ø 14-63 mm

QUICK-ADJUSTMENT
SZYBKONASTAWNY
 Ø 2"-5"
 Ø 50-127 mm

| | | |
|-------------|----------------------|----|
| YATO | Ø | |
| YT-2234 | 1/2"-5/2" (14-63 mm) | 25 |

| | | |
|-------------|-------------------|----|
| YATO | Ø | |
| YT-2235 | 2"-5" (50-127 mm) | 10 |

GB Window scraper
D Fensterabstreicher
PL Skrobak do szyb

RUS Скребок для стекла
CZ Skrobák na skla
H Kaparó üveghez

RO Răzuitor pt. geamuri
E Rascador de cristales
CN 玻璃刮刀

HALF
DOUBLE
BLISTER





 18x100
mm

SK5

 ALUMINIUM



ABS



| YATO  | L (mm) |  |
|--|--------|---|
| YT-7550 | 300 | 10/60 |



TELESCOPIC
HANDLE
390-600
mm

| YATO  | L (mm) |  |
|--|---------|---|
| YT-7551 | 390-600 | 10/60 |

GB Scraper
D Ziehklinge
PL Cyklina
RUS Цикля
CZ Skrabka na parkety

H Simitógyalu
RO Honuitor
E Raspador
CN 刮刀



HALF
DOUBLE
BLISTER



TUNGSTEN
CARBIDE
WEGLIK
WOLFRAM





BLADE
 22mm

| YATO  | L (mm) |  |
|--|--------|---|
| YT-5702 | 240 | 6/48 |





BLADE
 50 mm

| YATO  | L (mm) |  |
|--|--------|---|
| YT-5703 | 250 | 6/48 |



BLADE
 65 mm

| YATO  | L (mm) |  |
|--|--------|---|
| YT-5704 | 290 | 6/48 |

GB Steel file
 D Werkstatt-Feile
 PL Piłnik do metalu
 RUS Напильник слесарный
 CZ Zámeňický pilník



H Lakatos reszelő
 RO Pila de lăcătușerie
 E Lima para metal
 CN 锉



PLASTIC HANGER





| | | | |
|-----------|-----------|-----------|--------------|
| #1 | #2 | #3 | T12 STEEL |
| 150 mm | 200 mm | 250 mm | 300 mm |





| YATO  | # | L (mm) |  | |
|--|---------|--------|---|-------|
|  | YT-6223 | 1 | 250 | 20/80 |
| | YT-6180 | 2 | 150 | 20/80 |
| | YT-6185 | 2 | 200 | 20/80 |
| | YT-6228 | 2 | 250 | 20/80 |
| | YT-6190 | 2 | 300 | 10/40 |
| | YT-6233 | 3 | 250 | 20/80 |

| YATO  | # | L (mm) |  | |
|--|---------|--------|---|-------|
|  | YT-6224 | 1 | 250 | 20/80 |
| | YT-6181 | 2 | 150 | 20/80 |
| | YT-6186 | 2 | 200 | 20/80 |
| | YT-6229 | 2 | 250 | 20/80 |
| | YT-6191 | 2 | 300 | 10/40 |





| YATO  | # | L (mm) |  | |
|--|---------|--------|---|-------|
|  | YT-6225 | 1 | 250 | 20/80 |
| | YT-6182 | 2 | 150 | 20/80 |
| | YT-6187 | 2 | 200 | 20/80 |
| | YT-6230 | 2 | 250 | 20/80 |
| | YT-6192 | 2 | 300 | 10/40 |
| | YT-6234 | 3 | 250 | 20/80 |

| YATO  | # | L (mm) |  | |
|--|---------|--------|---|-------|
|  | YT-6226 | 1 | 250 | 20/80 |
| | YT-6183 | 2 | 150 | 20/80 |
| | YT-6188 | 2 | 200 | 20/80 |
| | YT-6231 | 2 | 250 | 20/80 |
| | YT-6193 | 2 | 300 | 10/40 |
| | YT-6235 | 3 | 250 | 20/80 |

10



| YATO  | # | L (mm) |  | |
|--|---------|--------|---|-------|
|  | YT-6227 | 1 | 250 | 20/80 |
| | YT-6184 | 2 | 150 | 20/80 |
| | YT-6189 | 2 | 200 | 20/80 |
| | YT-6232 | 2 | 250 | 20/80 |
| | YT-6194 | 2 | 300 | 10/40 |
| | YT-6236 | 3 | 250 | 20/80 |

GB Steel file set
 D Werkstatt-Feilen
 PL Piłniki do metalu
 RUS Набор напильников слесарных
 CZ Zámeňické pilníky

H Lakatos reszelő
 RO Pile de lăcătușerie
 E Juego de limas para metal
 CN 钢锉组套

SLIDING CARD





| | | |
|-----------|----|--------------|
| #1 | #2 | #3 |
| 250 mm | | T12 STEEL |

3 PCS

 #2

 #2

 #2



5 PCS

 #1 #2

 #1

 #1

 #1



5 PCS

 #3

 #3

 #3

 #3

 #3



| | |
|--|---|
| YATO  |  |
| YT-6237 | 10/20 |

| | |
|--|--|
| YATO  |  |
| YT-6238 | 5/10 |

| | |
|--|---|
| YATO  |  |
| YT-6239 | 5/10 |

GB Needle file set
D Nadelfeileinsatz
PL Zestaw pilników iglaków
RUS Набор напильников надфили
CZ Sada jehlových pilníků

H Tűreszelő készlet
RO Set pile conice
E Juego de limas de aguja
CN 什锦锉组套

POUCH

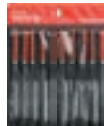

GCR15
BEARING
STEEL



6
PCS

10
PCS

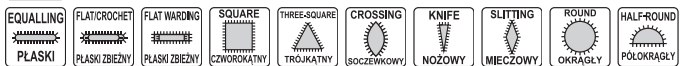

| YATO | working length / długość robocza (mm) | mm | |
|---------|--|-------|--------|
| YT-6160 | 65 | 3x140 | 50/200 |
| YT-6161 | 75 | 4x160 | 25/100 |
| YT-6162 | 85 | 5x180 | 25/100 |

| YATO | working length / długość robocza (mm) | mm | |
|---------|--|-------|--------|
| YT-6163 | 65 | 3x140 | 25/100 |
| YT-6164 | 75 | 4x160 | 25/100 |
| YT-6165 | 85 | 5x180 | 25/50 |

GB Diamond needle file
D Diamant-Nadelfeile
PL Pilnik iglak diamentowy
RUS Надфиль алмазный
CZ Diamantový jehlový pilník

H Gyémánt tűreszelő
RO Pila diamantata
E Lima de aguja adiamantada
CN 金刚石平头扁锉

SLIDING
CARD



GRIT
ZIARNISTOŚĆ
150



| YATO | grit / ziarnistość | coating length / długość nasypu (mm) | mm | |
|---------|-----------------------|---|-------|----------|
| YT-6140 | 150 | 50 | 3x140 | 120/1200 |
| YT-6147 | 150 | 50 | 4x160 | 80/800 |
| YT-6152 | 150 | 70 | 5x180 | 45/450 |

| YATO | grit / ziarnistość | coating length / długość nasypu (mm) | mm | |
|---------|-----------------------|---|-------|----------|
| YT-6141 | 150 | 50 | 3x140 | 120/1200 |
| YT-6148 | 150 | 50 | 4x160 | 80/800 |
| YT-6153 | 150 | 70 | 5x180 | 45/450 |

| YATO | grit / ziarnistość | coating length / długość nasypu (mm) | mm | |
|---------|-----------------------|---|-------|----------|
| YT-6142 | 150 | 50 | 3x140 | 120/1200 |
| YT-6149 | 150 | 50 | 4x160 | 80/800 |
| YT-6154 | 150 | 70 | 5x180 | 45/450 |

GB Diamond needle file set
D Diamant-Nadelfeileinsatz
PL Zestaw pilników diamentowych iglaków
RUS Набор надфилей алмазных
CZ Sada diamentových jehlových pilníků

H Gyémánt tűreszelő készlet
RO Set pile diamantate
E Juego de limas de aguja adiamantadas
CN 金刚石整形锉组套

POUCH



GRIT
ZIARNISTOŚĆ
150



3
PCS

5
PCS



| YATO | grit / ziarnistość | coating length / długość nasypu (mm) | mm | |
|---------|-----------------------|---|-------|--------|
| YT-6143 | 150 | 50 | 3x140 | 40/400 |
| YT-6150 | 150 | 50 | 4x160 | 30/300 |
| YT-6155 | 150 | 70 | 5x180 | 15/150 |

| YATO | grit / ziarnistość | coating length / długość nasypu (mm) | mm | |
|---------|-----------------------|---|-------|--------|
| YT-6156 | 150 | 70 | 5x180 | 10/100 |

GB Diamond needle file set
 D Diamant-Nadelfeilsatz
 PL Zestaw pilników diamentowych iglaków
 RUS Набор надфилей алмазных
 CZ Sada diamentových jehlových pilníků

H Gyémánt tűreszelő készlet
 RO Set pile diamantate
 E Juego de limas de aguja adiamantadas
 CN 金刚石整形锉组套

POUCH



10
PCS

GRIT
ZIARNISTOŚĆ
150



10

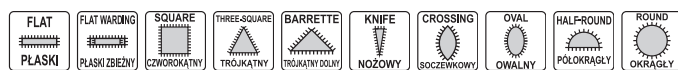

| YATO | grit / ziarnistość | coating length / długość nasypu (mm) | mm | |
|---------|-----------------------|---|-------|--------|
| YT-6144 | 150 | 50 | 3x140 | 12/120 |



| YATO | grit / ziarnistość | coating length / długość nasypu (mm) | mm | |
|---------|-----------------------|---|-------|--------|
| YT-6145 | 150 | 25 | 3x140 | 12/120 |

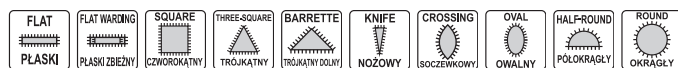

| YATO | grit / ziarnistość | coating length / długość nasypu (mm) | mm | |
|---------|-----------------------|---|-------|--------|
| YT-6146 | 150 | 30 | 3x140 | 12/120 |



| YATO | grit / ziarnistość | coating length / długość nasypu (mm) | mm | |
|---------|-----------------------|---|-------|------|
| YT-6151 | 150 | 50 | 4x160 | 9/90 |

GB Wood rasp
D Holzraspel
PL Tamik do drewna
RUS Рашпиля для дерева
CZ Rašple do dřeva

H Fareszelő
RO Raspe
E Escarpelo para madera
CN 木工锉



PLASTIC
HANGER



250
mm





45

| YATO  | # |  |
|--|----|---|
| YT-6219 | 45 | 12/72 |





45

| YATO  | # |  |
|--|----|---|
| YT-6220 | 45 | 12/72 |



45

| YATO  | # |  |
|--|----|---|
| YT-6221 | 45 | 12/72 |

GB Wood rasp set
D Holzraspelsatz
PL Tamiki do drewna
RUS Рашпили для дерева
CZ Sada rašplí do dřeva

H Fareszelő
RO Set raspe
E Juego de escarpelos para madera
CN 木工锉组套

SLIDING
CARD





3
PCS # 45

250
mm # 45

45



| YATO  | # |  |
|--|----|---|
| YT-6222 | 45 | 5/20 |

GB Sand paper PL Papier ścierny CZ Smirkový papír RO Hârtie abrazivă CN 砂纸
 D Schleifpapier RUS Наждачная бумага H Csiszolópapír E Papel de lija

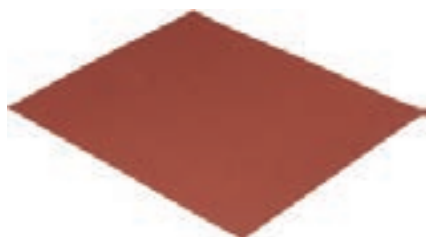

POLYBAG



- application: paint, lacquer, filler, wood
- abrasive: aluminium oxide
- bond: synthetic resin
- backing: C
- coating: semi-open
- zastosowanie: farby, lakiery, szpachle, drewno
- ścierniwo: tlenek aluminium
- spoiwo: żywica syntetyczna
- podkład: C
- nasyp półotwarty



- application: paint, lacquer, filler, wood
- abrasive: aluminium oxide
- bond: synthetic resin
- backing: D
- coating: semi-open
- zastosowanie: farby, lakiery, szpachle, drewno
- ścierniwo: tlenek aluminium
- spoiwo: żywica syntetyczna
- podkład: D
- nasyp półotwarty

| YATO | grit / ziarnistość | size / rozmiar (mm) | PCS packing | |
|---------|--------------------|---------------------|-------------|-----|
| YT-8350 | 40 | 230x280 | 50 | 500 |
| YT-8351 | 60 | 230x280 | 50 | 500 |
| YT-8352 | 80 | 230x280 | 50 | 500 |
| YT-8353 | 100 | 230x280 | 50 | 500 |
| YT-8354 | 120 | 230x280 | 50 | 500 |
| YT-8355 | 150 | 230x280 | 50 | 500 |
| YT-8356 | 180 | 230x280 | 50 | 500 |
| YT-8357 | 220 | 230x280 | 50 | 500 |
| YT-8358 | 240 | 230x280 | 50 | 500 |

| YATO | grit / ziarnistość | size / rozmiar | |
|---------|--------------------|----------------|-------|
| YT-8449 | 40 | 93 mm x 5 m | 12/48 |
| YT-8450 | 60 | 93 mm x 5 m | 12/48 |
| YT-8451 | 80 | 93 mm x 5 m | 12/48 |
| YT-8452 | 100 | 93 mm x 5 m | 12/48 |
| YT-8453 | 120 | 93 mm x 5 m | 12/48 |
| YT-8454 | 150 | 93 mm x 5 m | 12/48 |
| YT-8455 | 180 | 93 mm x 5 m | 12/48 |
| YT-8456 | 240 | 93 mm x 5 m | 12/48 |
| YT-8457 | 320 | 93 mm x 5 m | 12/48 |



POLYBAG WITH HEADER



- application: paint, lacquer, filler, wood
- abrasive: aluminium oxide
- bond: synthetic resin
- backing: D
- coating: semi-open
- zastosowanie: farby, lakiery, szpachle, drewno
- ścierniwo: tlenek aluminium
- spoiwo: żywica syntetyczna
- podkład: D
- nasyp półotwarty



- application: paint, lacquer, filler, wood
- abrasive: aluminium oxide
- bond: synthetic resin
- backing: D
- coating: semi-open
- zastosowanie: farby, lakiery, szpachle, drewno
- ścierniwo: tlenek aluminium
- spoiwo: żywica syntetyczna
- podkład: D
- nasyp półotwarty

| YATO | grit / ziarnistość | size / rozmiar (mm) | PCS packing | |
|---------|--------------------|---------------------|-------------|--------|
| YT-8370 | 40 | 115x280 | 5 | 24/240 |
| YT-8371 | 60 | 115x280 | 5 | 24/240 |
| YT-8372 | 80 | 115x280 | 5 | 24/240 |
| YT-8373 | 100 | 115x280 | 5 | 24/240 |
| YT-8374 | 120 | 115x280 | 5 | 24/240 |
| YT-8375 | 150 | 115x280 | 5 | 24/240 |
| YT-8376 | 180 | 115x280 | 5 | 24/240 |
| YT-8377 | 240 | 115x280 | 5 | 24/240 |
| YT-8378 | 320 | 115x280 | 5 | 24/240 |

| YATO | grit / ziarnistość | size / rozmiar | |
|---------|--------------------|----------------|-------|
| YT-8440 | 40 | 115 mm x 5 m | 12/48 |
| YT-8441 | 60 | 115 mm x 5 m | 12/48 |
| YT-8442 | 80 | 115 mm x 5 m | 12/48 |
| YT-8443 | 100 | 115 mm x 5 m | 12/48 |
| YT-8444 | 120 | 115 mm x 5 m | 12/48 |
| YT-8445 | 150 | 115 mm x 5 m | 12/48 |
| YT-8446 | 180 | 115 mm x 5 m | 12/48 |
| YT-8447 | 240 | 115 mm x 5 m | 12/48 |
| YT-8448 | 320 | 115 mm x 5 m | 12/48 |



POLYBAG



- application: paint, lacquer, filler, wood
- abrasive: aluminium oxide
- bond: synthetic resin
- backing: D
- coating: semi-open
- zastosowanie: farby, lakiery, szpachle, drewno
- ścierniwo: tlenek aluminium
- spoiwo: żywica syntetyczna
- podkład: D
- nasyp półotwarty



- application: paint, lacquer, filler, wood
- abrasive: aluminium oxide
- bond: synthetic resin
- backing: D
- coating: semi-open
- zastosowanie: farby, lakiery, szpachle, drewno
- ścierniwo: tlenek aluminium
- spoiwo: żywica syntetyczna
- podkład: D
- nasyp półotwarty

| YATO | grit / ziarnistość | size / rozmiar (mm) | PCS packing | |
|---------|--------------------|---------------------|-------------|-----|
| YT-8360 | 40 | 230x280 | 50 | 500 |
| YT-8361 | 60 | 230x280 | 50 | 500 |
| YT-8362 | 80 | 230x280 | 50 | 500 |
| YT-8363 | 100 | 230x280 | 50 | 500 |
| YT-8364 | 120 | 230x280 | 50 | 500 |
| YT-8365 | 150 | 230x280 | 50 | 500 |
| YT-8366 | 180 | 230x280 | 50 | 500 |
| YT-8367 | 240 | 230x280 | 50 | 500 |
| YT-8368 | 320 | 230x280 | 50 | 500 |

| YATO | grit / ziarnistość | size / rozmiar | |
|---------|--------------------|----------------|---|
| YT-8458 | 40 | 115 mm x 50 m | 2 |
| YT-8459 | 60 | 115 mm x 50 m | 2 |
| YT-8460 | 80 | 115 mm x 50 m | 2 |
| YT-8461 | 100 | 115 mm x 50 m | 2 |
| YT-8462 | 120 | 115 mm x 50 m | 2 |
| YT-8463 | 150 | 115 mm x 50 m | 2 |
| YT-8464 | 180 | 115 mm x 50 m | 2 |
| YT-8465 | 240 | 115 mm x 50 m | 2 |
| YT-8466 | 320 | 115 mm x 50 m | 2 |

GB Sand paper PL Papier ścierny CZ Smirkový papír RO Hârtie abrazivă CN 砂纸
D Schleifpapier RUS Наждачная бумага H Csiszolópapír E Papel de lija







- application: paint, lacquer, filler, wood
- abrasive: aluminium oxide
- bond: synthetic resin
- backing: F
- coating: closed

- zastosowanie: farby, lakiery, szpachle, drewno
- ścierniwo: tlenek aluminium
- spoiwo: żywica syntetyczna
- podkład: F
- nasyp pełny

- application: paint, lacquer, filler, wood
- abrasive: aluminium oxide
- bond: synthetic resin
- backing: F
- coating: closed

- zastosowanie: farby, lakiery, szpachle, drewno
- ścierniwo: tlenek aluminium
- spoiwo: żywica syntetyczna
- podkład: F
- nasyp pełny

| YATO  | grit / ziarnistość | size / rozmiar |  |
|--|--------------------|----------------|---|
| YT-8480 | 80 | 150 mm x 50 m | 2 |
| YT-8481 | 100 | 150 mm x 50 m | 2 |
| YT-8482 | 120 | 150 mm x 50 m | 2 |

| YATO  | grit / ziarnistość | size / rozmiar |  |
|--|--------------------|----------------|---|
| YT-8483 | 40 | 200 mm x 50 m | 2 |
| YT-8484 | 60 | 200 mm x 50 m | 2 |
| YT-8485 | 80 | 200 mm x 50 m | 2 |
| YT-8486 | 120 | 200 mm x 50 m | 2 |





WATERPROOF
WOODPROOFNY

POLYBAG



- application: paint, lacquer, filler
- abrasive: silicon carbide
- bond: synthetic resin
- backing: C
- coating: closed

- zastosowanie: farby, lakiery, szpachle
- ścierniwo: węgiel krzemu
- spoiwo: żywica syntetyczna
- podkład: C
- nasyp pełny

| YATO  | grit / ziarnistość | size / rozmiar (mm) | PCS packing |  |
|--|--------------------|---------------------|----------------|---|
| YT-8400 | 60 | 230x280 | 50 | 500 |
| YT-8401 | 80 | 230x280 | 50 | 500 |
| YT-8402 | 100 | 230x280 | 50 | 500 |
| YT-8403 | 120 | 230x280 | 50 | 500 |
| YT-8404 | 150 | 230x280 | 50 | 500 |



WATERPROOF
WOODPROOFNY

POLYBAG



- application: paint, lacquer, filler
- abrasive: silicon carbide
- bond: synthetic resin
- backing: A
- coating: closed

- zastosowanie: farby, lakiery, szpachle
- ścierniwo: węgiel krzemu
- spoiwo: żywica syntetyczna
- podkład: A
- nasyp pełny



| YATO  | grit / ziarnistość | size / rozmiar (mm) | PCS packing |  |
|--|--------------------|---------------------|----------------|---|
| YT-8405 | 180 | 230x280 | 50 | 500 |
| YT-8406 | 220 | 230x280 | 50 | 500 |
| YT-8407 | 240 | 230x280 | 50 | 500 |
| YT-8408 | 280 | 230x280 | 50 | 500 |
| YT-8409 | 320 | 230x280 | 50 | 500 |
| YT-8410 | 360 | 230x280 | 50 | 500 |
| YT-8411 | 400 | 230x280 | 50 | 500 |
| YT-8412 | 500 | 230x280 | 50 | 500 |
| YT-8413 | 600 | 230x280 | 50 | 500 |
| YT-8414 | 800 | 230x280 | 50 | 500 |
| YT-8415 | 1000 | 230x280 | 50 | 500 |
| YT-8416 | 1200 | 230x280 | 50 | 500 |
| YT-8417 | 1500 | 230x280 | 50 | 500 |
| YT-8418 | 2000 | 230x280 | 50 | 500 |

GB Abrasive cloth sheet H Csiszolóvászon lap
 D Schleifgewebe blatt RO Coli panza abraziva
 PL Piłtno ściernie arkusz E Hojas de pano abrasivo
 RUS Шлифовальное полотно CN 砂布
 CZ Brusné plátno

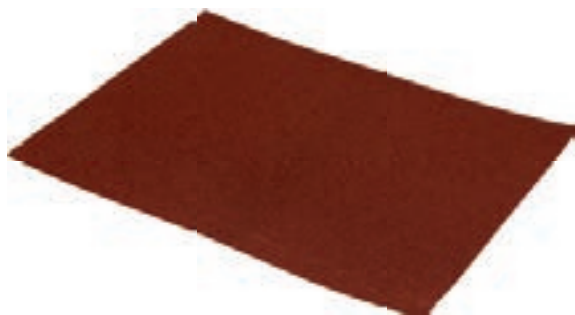
POLYBAG





- application: metal, wood
- abrasive: aluminium oxide
- bond: semi-resin
- backing: J
- coating: close
- zastosowanie: metal, drewno
- ścierniwo: tlenek aluminium
- spoiwo: żywica
- podkład: J
- nasyp pełny



| YATO  | grit / ziarnistość | size / rozmiar (mm) | PCS packing |  |
|--|--------------------|---------------------|----------------|---|
| YT-83160 | 36 | 230x280 | 50 | 250 |
| YT-83161 | 40 | 230x280 | 50 | 250 |
| YT-83162 | 60 | 230x280 | 50 | 250 |
| YT-83163 | 80 | 230x280 | 50 | 250 |
| YT-83164 | 100 | 230x280 | 50 | 250 |
| YT-83165 | 120 | 230x280 | 50 | 500 |
| YT-83166 | 150 | 230x280 | 50 | 500 |
| YT-83167 | 180 | 230x280 | 50 | 500 |
| YT-83168 | 220 | 230x280 | 50 | 500 |
| YT-83169 | 240 | 230x280 | 50 | 500 |

GB Abrasive cloth roll H Csiszolóvászon tekercs
 D Schleifgewebe rolle RO Rola panza abraziva
 PL Piłtno ściernie rolka E Rollo de pano abrasivo
 RUS Рулон-шлифовальное полотно CN 砂布
 CZ Brusné plátno role



- application: metal, wood
- abrasive: aluminium oxide
- bond: semi-resin
- backing: J
- coating: close
- zastosowanie: metal, drewno
- ścierniwo: tlenek aluminium
- spoiwo: żywica
- podkład: J
- nasyp pełny
- application: metal, wood
- abrasive: aluminium oxide
- bond: semi-resin
- backing: J
- coating: close
- zastosowanie: metal, drewno
- ścierniwo: tlenek aluminium
- spoiwo: żywica
- podkład: J
- nasyp pełny
- application: metal, wood
- abrasive: aluminium oxide
- bond: semi-resin
- backing: J
- coating: close
- zastosowanie: metal, drewno
- ścierniwo: tlenek aluminium
- spoiwo: żywica
- podkład: J
- nasyp pełny

| YATO  | grit / ziarnistość | size / rozmiar | PCS packing |  |
|--|--------------------|----------------|----------------|---|
| YT-83180 | 36 | 150 mm x 30 m | 2 | |
| YT-83181 | 40 | 150 mm x 30 m | 2 | |



| YATO  | grit / ziarnistość | size / rozmiar | PCS packing |  |
|--|--------------------|----------------|----------------|--|
| YT-83182 | 50 | 150 mm x 50 m | 2 | |
| YT-83183 | 60 | 150 mm x 50 m | 2 | |
| YT-83184 | 80 | 150 mm x 50 m | 2 | |
| YT-83185 | 100 | 150 mm x 50 m | 2 | |
| YT-83186 | 120 | 150 mm x 50 m | 2 | |
| YT-83187 | 150 | 150 mm x 50 m | 2 | |
| YT-83188 | 180 | 150 mm x 50 m | 2 | |
| YT-83189 | 220 | 150 mm x 50 m | 2 | |
| YT-83190 | 240 | 150 mm x 50 m | 2 | |



| YATO  | grit / ziarnistość | size / rozmiar | PCS packing |  |
|--|--------------------|----------------|----------------|---|
| YT-83200 | 24 | 200mm x 30 m | 2 | |
| YT-83201 | 36 | 200mm x 30 m | 2 | |
| YT-83202 | 40 | 200mm x 30 m | 2 | |
| YT-83203 | 50 | 200mm x 30 m | 2 | |
| YT-83204 | 60 | 200mm x 30 m | 2 | |
| YT-83205 | 80 | 200mm x 30 m | 2 | |
| YT-83206 | 100 | 200mm x 30 m | 2 | |
| YT-83207 | 120 | 200mm x 30 m | 2 | |
| YT-83208 | 150 | 200mm x 30 m | 2 | |
| YT-83209 | 180 | 200mm x 30 m | 2 | |
| YT-83210 | 220 | 200mm x 30 m | 2 | |
| YT-83211 | 240 | 200mm x 30 m | 2 | |



GB No end abrasive band H Csiszolóvászon szalag
 D Schleifband RO Curea abraziva
 PL Pas ścierny bezkońcowy E Banda abrasiva sin fin
 RUS Шлифлента бесконечная CN 砂带
 CZ Brusny pas



- application: metal, wood
- abrasive: aluminium oxide
- bond: synthetic resin
- coating: close
- zastosowanie: metal, drewno
- ścierniwo: tlenek aluminium
- spoiwo: żywica syntetyczna
- nasyp pełny
- application: metal, wood
- abrasive: aluminium oxide
- bond: synthetic resin
- coating: close
- zastosowanie: metal, drewno
- ścierniwo: tlenek aluminium
- spoiwo: żywica syntetyczna
- nasyp pełny
- application: metal, wood
- abrasive: aluminium oxide
- bond: synthetic resin
- coating: close
- zastosowanie: metal, drewno
- ścierniwo: tlenek aluminium
- spoiwo: żywica syntetyczna
- nasyp pełny

| YATO  | grit / ziarnistość | size / rozmiar (mm) | PCS packing |  |
|--|--------------------|---------------------|----------------|---|
| YT-83220 | 36 | 75x457 | 5 | 20/60 |
| YT-83221 | 40 | 75x457 | 5 | 20/60 |
| YT-83222 | 60 | 75x457 | 5 | 20/60 |
| YT-83223 | 80 | 75x457 | 5 | 20/60 |
| YT-83224 | 100 | 75x457 | 5 | 20/60 |
| YT-83225 | 120 | 75x457 | 5 | 20/60 |
| YT-83226 | 150 | 75x457 | 5 | 20/60 |



| YATO  | grit / ziarnistość | size / rozmiar (mm) | PCS packing |  |
|--|--------------------|---------------------|----------------|--|
| YT-83227 | 36 | 75x533 | 5 | 20/60 |
| YT-83228 | 40 | 75x533 | 5 | 20/60 |
| YT-83229 | 60 | 75x533 | 5 | 20/60 |
| YT-83230 | 80 | 75x533 | 5 | 20/60 |
| YT-83231 | 100 | 75x533 | 5 | 20/60 |
| YT-83232 | 120 | 75x533 | 5 | 20/60 |
| YT-83233 | 150 | 75x533 | 5 | 20/60 |

| YATO  | grit / ziarnistość | size / rozmiar (mm) | PCS packing |  |
|--|--------------------|---------------------|----------------|---|
| YT-83234 | 36 | 100x610 | 5 | 10/30 |
| YT-83235 | 40 | 100x610 | 5 | 10/30 |
| YT-83236 | 60 | 100x610 | 5 | 10/30 |
| YT-83237 | 80 | 100x610 | 5 | 20/60 |
| YT-83238 | 100 | 100x610 | 5 | 20/60 |
| YT-83239 | 120 | 100x610 | 5 | 20/60 |
| YT-83240 | 150 | 100x610 | 5 | 20/60 |

GB Flap disc – regular shape
D Fächerschleifscheibe - Gerade
PL Ściernica listkowa talerzowa płaska
RUS Круг лепестковый тарельчатый
CZ Lamelový brusný kotouč

H Lamellás csiszoló normál
RO Disc lamelar frontal
E Discos de paño abrasivo
CN 百叶轮

- application: metal
- abrasive: aluminium oxide
- bond: synthetic resin
- backing: fibreglass
- zastosowanie: metal
- ścierniwo: tlenek aluminium
- spoiwo: żywica syntetyczna
- podkład: włókno szklane



| YATO  | grit / ziarnistość | size / rozmiar (mm) |  |
|--|-----------------------|------------------------|---|
| YT-83251 | 36 | 115x22.4 | 50/200 |
| YT-83252 | 40 | 115x22.4 | 50/200 |
| YT-83253 | 60 | 115x22.4 | 50/200 |
| YT-83254 | 80 | 115x22.4 | 50/200 |
| YT-83255 | 100 | 115x22.4 | 50/200 |
| YT-83256 | 120 | 115x22.4 | 50/200 |



GB Flap disc – regular shape
D Fächerschleifscheibe - Gerade
PL Ściernica listkowa talerzowa płaska
RUS Круг лепестковый тарельчатый
CZ Lamelový brusný kotouč

H Lamellás csiszoló normál
RO Disc lamelar frontal
E Discos de paño abrasivo
CN 百叶轮

- application: metal
- abrasive: aluminium oxide
- bond: synthetic resin
- backing: fibreglass
- zastosowanie: metal
- ścierniwo: tlenek aluminium
- spoiwo: żywica syntetyczna
- podkład: włókno szklane



| YATO  | grit / ziarnistość | size / rozmiar (mm) |  |
|--|-----------------------|------------------------|---|
| YT-83271 | 36 | 125x22.4 | 25/100 |
| YT-83272 | 40 | 125x22.4 | 25/100 |
| YT-83273 | 60 | 125x22.4 | 50/200 |
| YT-83274 | 80 | 125x22.4 | 50/200 |
| YT-83275 | 100 | 125x22.4 | 50/200 |
| YT-83276 | 120 | 125x22.4 | 50/200 |



GB Flap disc – depressed shape
D Fächerschleifscheibe - Gewölbt
PL Ściernica listkowa talerzowa wypukła
RUS Круг лепестковый тарельчатый
CZ Lamelový brusný kotouč - vypouklý
H Lamellás csiszoló döntött

RO Disc lamelar frontal depresat
E Discos de paño abrasivo centro embutido
CN 百叶轮

- application: metal
- abrasive: aluminium oxide
- bond: synthetic resin
- backing: fibreglass
- zastosowanie: metal
- ścierniwo: tlenek aluminium
- spoiwo: żywica syntetyczna
- podkład: włókno szklane



| YATO  | grit / ziarnistość | size / rozmiar (mm) |  |
|--|-----------------------|------------------------|---|
| YT-83281 | 36 | 115x22.4 | 50/200 |
| YT-83282 | 40 | 115x22.4 | 50/200 |
| YT-83283 | 60 | 115x22.4 | 50/200 |
| YT-83284 | 80 | 115x22.4 | 50/200 |
| YT-83285 | 100 | 115x22.4 | 50/200 |
| YT-83286 | 120 | 115x22.4 | 50/200 |



GB Flap disc – depressed shape
D Fächerschleifscheibe - Gewölbt
PL Ściernica listkowa talerzowa wypukła
RUS Круг лепестковый тарельчатый
CZ Lamelový brusný kotouč - vypouklý
H Lamellás csiszoló döntött

RO Disc lamelar frontal depresat
E Discos de paño abrasivo centro embutido
CN 百叶轮

- application: metal
- abrasive: aluminium oxide
- bond: synthetic resin
- backing: fibreglass
- zastosowanie: metal
- ścierniwo: tlenek aluminium
- spoiwo: żywica syntetyczna
- podkład: włókno szklane



| YATO  | grit / ziarnistość | size / rozmiar (mm) |  |
|--|-----------------------|------------------------|---|
| YT-83291 | 36 | 125x22.4 | 25/100 |
| YT-83292 | 40 | 125x22.4 | 25/100 |
| YT-83293 | 60 | 125x22.4 | 50/200 |
| YT-83294 | 80 | 125x22.4 | 50/200 |
| YT-83295 | 100 | 125x22.4 | 50/200 |
| YT-83296 | 120 | 125x22.4 | 50/200 |



GB Flap disc – regular shape
D Fächerschleifscheibe - Gerade
PL Ściernica listkowa talerzowa płaska
RUS Круг лепестковый тарельчатый
CZ Lamelový brusný kotouč
H Lamellás csiszoló normál

RO Disc lamelar frontal
E Discos de paño abrasivo
CN 百叶轮

- application: metal, inox
- abrasive: zirconia aluminium oxide
- bond: synthetic resin
- backing: fibreglass
- zastosowanie: metal, stal nierdzewna
- ścierniwo: tlenek aluminium / dwutlenek cyrkonu
- spoiwo: żywica syntetyczna
- podkład: włókno szklane



| YATO  | grit / ziarnistość | size / rozmiar (mm) |  |
|--|-----------------------|------------------------|---|
| YT-83301 | 36 | 115x22.4 | 50/200 |
| YT-83302 | 40 | 115x22.4 | 50/200 |
| YT-83303 | 60 | 115x22.4 | 50/200 |
| YT-83304 | 80 | 115x22.4 | 50/200 |
| YT-83305 | 100 | 115x22.4 | 50/200 |
| YT-83306 | 120 | 115x22.4 | 50/200 |



GB Flap disc – regular shape
D Fächerschleifscheibe - Gerade
PL Ściernica listkowa talerzowa płaska
RUS Круг лепестковый тарельчатый
CZ Lamelový brusný kotouč
H Lamellás csiszoló normál

RO Disc lamelar frontal
E Discos de paño abrasivo
CN 百叶轮

- application: metal, inox
- abrasive: zirconia aluminium oxide
- bond: synthetic resin
- backing: fibreglass
- zastosowanie: metal, stal nierdzewna
- ścierniwo: tlenek aluminium / dwutlenek cyrkonu
- spoiwo: żywica syntetyczna
- podkład: włókno szklane



| YATO  | grit / ziarnistość | size / rozmiar (mm) |  |
|--|-----------------------|------------------------|---|
| YT-83311 | 36 | 125x22.4 | 25/100 |
| YT-83312 | 40 | 125x22.4 | 25/100 |
| YT-83313 | 60 | 125x22.4 | 25/100 |
| YT-83314 | 80 | 125x22.4 | 50/200 |
| YT-83315 | 100 | 125x22.4 | 50/200 |
| YT-83316 | 120 | 125x22.4 | 50/200 |



GB Flap disc – depressed shape
D Fächerschleifscheibe - Gewölbt
PL Ściernica listkowa talerzowa wypukła
RUS Круг лепестковый тарельчатый
CZ Lamelový brusný kotouč - vypouklý
H Lamellás csiszoló döntött

RO Disc lamelar frontal depresat
E Discos de paño abrasivo centro embutido
CN 百叶轮

- application: metal, inox
- abrasive: zirconia aluminium oxide
- bond: synthetic resin
- backing: fibreglass
- zastosowanie: metal, stal nierdzewna
- ścierniwo: tlenek aluminium / dwutlenek cyrkonu
- spoiwo: żywica syntetyczna
- podkład: włókno szklane



| YATO  | grit / ziarnistość | size / rozmiar (mm) |  |
|--|-----------------------|------------------------|---|
| YT-83321 | 36 | 115x22.4 | 50/200 |
| YT-83322 | 40 | 115x22.4 | 50/200 |
| YT-83323 | 60 | 115x22.4 | 50/200 |
| YT-83324 | 80 | 115x22.4 | 50/200 |
| YT-83325 | 100 | 115x22.4 | 50/200 |
| YT-83326 | 120 | 115x22.4 | 50/200 |



GB Flap disc – depressed shape
D Fächerschleifscheibe - Gewölbt
PL Ściernica listkowa talerzowa wypukła
RUS Круг лепестковый тарельчатый
CZ Lamelový brusný kotouč - vypouklý
H Lamellás csiszoló döntött

RO Disc lamelar frontal depresat
E Discos de paño abrasivo centro embutido
CN 百叶轮

- application: metal, inox
- abrasive: zirconia aluminium oxide
- bond: synthetic resin
- backing: fibreglass
- zastosowanie: metal, stal nierdzewna
- ścierniwo: tlenek aluminium / dwutlenek cyrkonu
- spoiwo: żywica syntetyczna
- podkład: włókno szklane

| YATO  | grit / ziarnistość | size / rozmiar (mm) |  |
|--|-----------------------|------------------------|---|
| YT-83331 | 36 | 125x22.4 | 25/100 |
| YT-83332 | 40 | 125x22.4 | 25/100 |
| YT-83333 | 60 | 125x22.4 | 25/100 |
| YT-83334 | 80 | 125x22.4 | 50/200 |
| YT-83335 | 100 | 125x22.4 | 50/200 |
| YT-83336 | 120 | 125x22.4 | 50/200 |



GB Flap wheel with shaft
D Fächerschleifmop mit Schaft
PL Ściernica listkowa trzpieniowa

RUS Круг лепестковый со шпинделем
CZ Lamelový kotouč s hřídelem
H Legyező csiszoló csapos

RO Perie abraziva circulara cu tija
E Rueda laminar en tela abrasiva
CN 百叶轮



- application: metal
- abrasive: aluminium oxide
- bond: synthetic resin
- zastosowanie: metal
- ścierniwo: tlenek aluminium
- spoiwo: żywica syntetyczna



- application: metal
- abrasive: aluminium oxide
- bond: synthetic resin
- zastosowanie: metal
- ścierniwo: tlenek aluminium
- spoiwo: żywica syntetyczna

| YATO | grit / ziarnistość | size / rozmiar (mm) | |
|----------|--------------------|---------------------|-------|
| YT-83351 | 40 | 40x20x6 | 10/60 |
| YT-83352 | 60 | 40x20x6 | 10/60 |
| YT-83353 | 80 | 40x20x6 | 10/60 |
| YT-83354 | 100 | 40x20x6 | 10/60 |
| YT-83355 | 120 | 40x20x6 | 10/60 |
| YT-83356 | 150 | 40x20x6 | 10/60 |

| YATO | grit / ziarnistość | size / rozmiar (mm) | |
|----------|--------------------|---------------------|-------|
| YT-83361 | 40 | 60x30x6 | 10/60 |
| YT-83362 | 60 | 60x30x6 | 10/60 |
| YT-83363 | 80 | 60x30x6 | 10/60 |
| YT-83364 | 100 | 60x30x6 | 10/60 |
| YT-83365 | 120 | 60x30x6 | 10/60 |
| YT-83366 | 150 | 60x30x6 | 10/60 |



- application: metal
- abrasive: aluminium oxide
- bond: synthetic resin
- zastosowanie: metal
- ścierniwo: tlenek aluminium
- spoiwo: żywica syntetyczna



- application: metal
- abrasive: aluminium oxide
- bond: synthetic resin
- zastosowanie: metal
- ścierniwo: tlenek aluminium
- spoiwo: żywica syntetyczna

| YATO | grit / ziarnistość | size / rozmiar (mm) | |
|----------|--------------------|---------------------|-------|
| YT-83371 | 40 | 80x30x6 | 10/60 |
| YT-83372 | 60 | 80x30x6 | 10/60 |
| YT-83373 | 80 | 80x30x6 | 10/60 |
| YT-83374 | 100 | 80x30x6 | 10/60 |
| YT-83375 | 120 | 80x30x6 | 10/60 |
| YT-83376 | 150 | 80x30x6 | 10/60 |

| YATO | grit / ziarnistość | size / rozmiar (mm) | |
|----------|--------------------|---------------------|-------|
| YT-83381 | 40 | 80x40x6 | 10/60 |
| YT-83382 | 60 | 80x40x6 | 10/60 |
| YT-83383 | 80 | 80x40x6 | 10/60 |
| YT-83384 | 100 | 80x40x6 | 10/60 |
| YT-83385 | 120 | 80x40x6 | 10/60 |
| YT-83386 | 150 | 80x40x6 | 10/60 |

GB Flap wheel with shaft
D Fächerschleifmop mit Schaft
PL Ściernica listkowa trzpieniowa
RUS Круг лепестковый со шпинделем
CZ Lamelový kotouč s hřídelem

H Legyező csiszoló csapos
RO Perie abraziva circulara cu tija
E Rueda laminar en tela abrasiva
CN 百叶轮



- application: metal
- abrasive: aluminium oxide
- bond: synthetic resin

- zastosowanie: metal
- ścierniwo: tlenek aluminium
- spoiwo: żywica syntetyczna



- application: metal
- abrasive: aluminium oxide
- bond: synthetic resin

- zastosowanie: metal
- ścierniwo: tlenek aluminium
- spoiwo: żywica syntetyczna



- application: metal
- abrasive: aluminium oxide
- bond: synthetic resin

- zastosowanie: metal
- ścierniwo: tlenek aluminium
- spoiwo: żywica syntetyczna

| YATO | grit / ziarnistość | size / rozmiar (mm) | |
|----------|--------------------|---------------------|-------|
| YT-83390 | 60 | 50x30x6 | 10/60 |
| YT-83391 | 100 | 50x30x6 | 10/60 |
| YT-83392 | 150 | 50x30x6 | 10/60 |
| YT-83393 | 200 | 50x30x6 | 10/60 |

| YATO | grit / ziarnistość | size / rozmiar (mm) | |
|----------|--------------------|---------------------|-------|
| YT-83394 | 60 | 60x50x6 | 10/60 |
| YT-83395 | 100 | 60x50x6 | 10/60 |
| YT-83396 | 150 | 60x50x6 | 10/60 |
| YT-83397 | 200 | 60x50x6 | 10/60 |

| YATO | grit / ziarnistość | size / rozmiar (mm) | |
|----------|--------------------|---------------------|-------|
| YT-83398 | 60 | 80x50x6 | 10/60 |
| YT-83399 | 100 | 80x50x6 | 10/60 |
| YT-83400 | 150 | 80x50x6 | 10/60 |
| YT-83401 | 200 | 80x50x6 | 10/60 |

GB Abrasive disc
D Schleifpapier
zum Gummiteiler
PL Kązek ściemy
RUS Круг шлифовальный
CZ Brusný kotouč
H Csiszolótárcsa
RO Disc abraziv
E Juego de discos abrasivos
CN 圆形砂纸



- application: metal, wood
- abrasive: aluminium oxide
- bond: synthetic resin
- backing: C
- coating: semi-open
- zastosowanie: metal, drewno
- ściemiwo: tlenek aluminium
- spoiwo: żywica syntetyczna
- podkład: C
- nasyp półotwarty

5
PCS

HOOK
FASTENER
RZEP

| YATO | grit / ziarnistość | Ø (mm) | 📦 |
|----------|-----------------------|--------|--------|
| YT-83420 | 36 | 115 | 50/200 |
| YT-83421 | 40 | 115 | 50/200 |
| YT-83422 | 60 | 115 | 50/200 |
| YT-83423 | 80 | 115 | 50/200 |
| YT-83424 | 100 | 115 | 50/200 |
| YT-83425 | 120 | 115 | 50/200 |
| YT-83426 | 150 | 115 | 50/200 |
| YT-83427 | 180 | 115 | 50/200 |
| YT-83428 | 220 | 115 | 50/200 |

GB Abrasive disc
D Schleifpapier
zum Gummiteiler
PL Kązek ściemy
RUS Круг шлифовальный
CZ Brusný kotouč
H Csiszolótárcsa
RO Disc abraziv
E Juego de discos abrasivos
CN 圆形砂纸



- application: metal, wood
- abrasive: aluminium oxide
- bond: synthetic resin
- backing: C
- coating: semi-open
- zastosowanie: metal, drewno
- ściemiwo: tlenek aluminium
- spoiwo: żywica syntetyczna
- podkład: C
- nasyp półotwarty

5
PCS

HOOK
FASTENER
RZEP

| YATO | grit / ziarnistość | Ø (mm) | 📦 |
|----------|-----------------------|--------|--------|
| YT-83430 | 36 | 125 | 50/200 |
| YT-83431 | 40 | 125 | 50/200 |
| YT-83432 | 60 | 125 | 50/200 |
| YT-83433 | 80 | 125 | 50/200 |
| YT-83434 | 100 | 125 | 50/200 |
| YT-83435 | 120 | 125 | 50/200 |
| YT-83436 | 150 | 125 | 50/200 |
| YT-83437 | 180 | 125 | 50/200 |
| YT-83438 | 220 | 125 | 50/200 |

GB Abrasive disc with holes
D Schleifpapier
zum Gummiteiler mit lochen
PL Kązek ściemy z otworami
RUS Круг шлифовальный
перфорированный с липучкой
CZ Brusný kotouč z otvorami
H Fibertárcsa lyukakkal tépözárás
RO Disc abraziv cu orificii
E Juego de discos abrasivos con agujeros
CN 圆形带孔砂纸



- application: metal, wood
- abrasive: aluminium oxide
- bond: synthetic resin
- backing: C
- coating: semi-open
- zastosowanie: metal, drewno
- ściemiwo: tlenek aluminium
- spoiwo: żywica syntetyczna
- podkład: C
- nasyp półotwarty

5
PCS

HOOK
FASTENER
RZEP



| YATO | grit / ziarnistość | Ø (mm) | 📦 |
|----------|-----------------------|--------|--------|
| YT-83440 | 36 | 115 | 50/200 |
| YT-83441 | 40 | 115 | 50/200 |
| YT-83442 | 60 | 115 | 50/200 |
| YT-83443 | 80 | 115 | 50/200 |
| YT-83444 | 100 | 115 | 50/200 |
| YT-83445 | 120 | 115 | 50/200 |
| YT-83446 | 150 | 115 | 50/200 |
| YT-83447 | 180 | 115 | 50/200 |
| YT-83448 | 220 | 115 | 50/200 |

GB Abrasive disc with holes
D Schleifpapier
zum Gummiteiler mit lochen
PL Kązek ściemy z otworami
RUS Круг шлифовальный
перфорированный с липучкой
CZ Brusný kotouč z otvorami
H Fibertárcsa lyukakkal tépözárás
RO Disc abraziv cu orificii
E Juego de discos abrasivos con agujeros
CN 圆形带孔砂纸

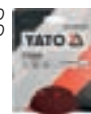

- application: metal, wood
- abrasive: aluminium oxide
- bond: synthetic resin
- backing: C
- coating: semi-open
- zastosowanie: metal, drewno
- ściemiwo: tlenek aluminium
- spoiwo: żywica syntetyczna
- podkład: C
- nasyp półotwarty

5
PCS

HOOK
FASTENER
RZEP



| YATO | grit / ziarnistość | Ø (mm) | 📦 |
|----------|-----------------------|--------|--------|
| YT-83450 | 36 | 125 | 50/200 |
| YT-83451 | 40 | 125 | 50/200 |
| YT-83452 | 60 | 125 | 50/200 |
| YT-83453 | 80 | 125 | 50/200 |
| YT-83454 | 100 | 125 | 50/200 |
| YT-83455 | 120 | 125 | 50/200 |
| YT-83456 | 150 | 125 | 50/200 |
| YT-83457 | 180 | 125 | 50/200 |
| YT-83458 | 220 | 125 | 50/200 |

GB Abrasive sheet with holes
D Schleifgewebe-scheiben mit lochen
PL Arkusz ściemy z otworami
RUS Шлифовальная перфорированная
бумага для виброшлифмашинки
CZ Brusné archy z otvorami
H Csiszoló lap lyukakkal
RO Coale (foi) abrazive cu orificii
E Ojas abrasivas con agujeros
CN 方形带孔砂纸



5
PCS

HOOK
FASTENER
RZEP



| YATO | grit / ziarnistość | size / rozmiar (mm) | 📦 |
|----------|-----------------------|------------------------|--------|
| YT-83480 | 40 | 93x180 | 25/100 |
| YT-83481 | 60 | 93x180 | 25/100 |
| YT-83482 | 80 | 93x180 | 25/100 |
| YT-83483 | 100 | 93x180 | 25/100 |
| YT-83484 | 120 | 93x180 | 25/100 |
| YT-83485 | 150 | 93x180 | 50/200 |
| YT-83486 | 180 | 93x180 | 50/200 |
| YT-83487 | 220 | 93x180 | 50/200 |
| YT-83488 | 240 | 93x180 | 50/200 |

TIED
ON CARD



- application: paint, lacquer, filler
- abrasive: aluminium oxide
- bond: synthetic resin
- backing: C
- coating: semi-open
- zastosowanie: farby, lakiery, szpachle
- ściemiwo: tlenek aluminium
- spoiwo: żywica syntetyczna
- podkład: C
- nasyp półotwarty

GB Abrasive sheet with holes
D Schleifgewebe-scheiben mit lochen
PL Arkusz ściemy z otworami
RUS Шлифовальная перфорированная
бумага для виброшлифмашинки
CZ Brusné archy z otvorami
H Csiszoló lap lyukakkal
RO Coale (foi) abrazive cu orificii
E Ojas abrasivas con agujeros
CN 方形带孔砂纸



5
PCS

HOOK
FASTENER
RZEP



TIED
ON CARD



- application: metal, wood
- abrasive: aluminium oxide
- bond: synthetic resin
- backing: C
- coating: semi-open
- zastosowanie: metal, drewno
- ściemiwo: tlenek aluminium
- spoiwo: żywica syntetyczna
- podkład: C
- nasyp półotwarty

| YATO | grit / ziarnistość | size / rozmiar (mm) | 📦 |
|----------|-----------------------|------------------------|--------|
| YT-83490 | 40 | 93x230 | 25/100 |
| YT-83491 | 60 | 93x230 | 25/100 |
| YT-83492 | 80 | 93x230 | 25/100 |
| YT-83493 | 100 | 93x230 | 25/100 |
| YT-83494 | 120 | 93x230 | 25/100 |
| YT-83495 | 150 | 93x230 | 25/100 |
| YT-83496 | 180 | 93x230 | 25/100 |
| YT-83497 | 220 | 93x230 | 25/100 |
| YT-83498 | 240 | 93x230 | 25/100 |

GB Sanding block
D Handschleifer
PL Blok ściemy
RUS Брусок
для шлифования
CZ Brusný blok
H Suport smirghel
RO Csiszolóblokk
E Bloque abrasivo
CN 砂板器



TIED
ON CARD



| YATO | mm | 📦 |
|---------|---------|------|
| YT-5320 | 223x85 | 6/36 |
| YT-5321 | 223x105 | 6/36 |

11

Hydraulic tools Narzędzia hydrauliczne



Ratchet die stock sets
Komplety gwintownic ręcznych

208



Water pump pliers
Szczypce nastawne

209



Accessories for ratchet die stock
Akcesoria do gwintownic ręcznych

208



Pipe cutters
Obcinaki do rur

210



Pipe wrenches
Klucze do rur

208-209



Hand flaring tools sets
Praski do rozszerzania rur

211



Chain pipe wrenches
Klucze do rur łańcuchowe

209



Hinged pipe vices
Imadła zaciskowe do rur

211



GB Ratchet die stock
 D Handgewindebohrer
 PL Gwintownica ręczna
 RUS Ручный метчик
 CZ Závitníky
 H Menetfúró
 RO Tarazi
 E Machos de roscar
 CN 管子铰板组套



| | | | |
|----------|-------|------|--------|
| 7 PCS | 1/4" | 3/8" | 1/2" |
| | 6.3mm | 10mm | 12.5mm |
| 9Cr2 | 3/4" | 1" | 5/4" |
| | 19mm | 25mm | 32mm |



BMC & COLOR SLEEVE

| YATO | size / rozmiar | |
|---------|---|---|
| YT-2900 | 1/4" (6.3 mm); 3/8" (10.0 mm); 1/2" (12.5 mm); 3/4" (19.0 mm); 1" (25.0 mm); 5/4" (32.0 mm) | 4 |

GB Spare knives for ratchet die stock
 D Rohrgewinde-Schneidbacken
 PL Noże zapasowe do gwintownicy ręcznej
 RUS Запасные ножи для оправки
 CZ Náhradní nože do ručního závitomězu

H Tartalék kések, racsnis csőmenetvágóhoz
 RO Cutit de rezerva pt. filiera
 E Filos de recambio para terraja de mano
 CN 板牙

4
PCS
9Cr2



POLYBAG WITH HEADER

| YATO | size / rozmiar | PCS packing | |
|---------|----------------|-------------|--------|
| YT-2910 | 1/4" (6.3 mm) | 4 | 50/200 |
| YT-2911 | 3/8" (10.0 mm) | 4 | 50/200 |
| YT-2912 | 1/2" (12.5 mm) | 4 | 50/200 |
| YT-2913 | 3/4" (19.0 mm) | 4 | 50/200 |
| YT-2914 | 1" (25.0 mm) | 4 | 50/200 |

GB Spare head for ratchet die stock
 D Rohrgewinde-Schneidköpfe
 PL Glowica zapasowa do gwintownicy ręcznej
 RUS Запасная оправка для нарезания трубной резьбы
 CZ Náhradní hlava pro ruční závitoměr
 H Tartalék fej, racsnis csőmenetvágóhoz
 RO Cap de rezerva pt. placa filetat cu clichet
 E Cabeza de recambio para terraja de mano
 CN 板牙头



9Cr2

COLOR BOX

| YATO | size / rozmiar | |
|---------|----------------|-------|
| YT-2916 | 1/4" (6.3 mm) | 10/40 |
| YT-2917 | 3/8" (10.0 mm) | 10/40 |
| YT-2918 | 1/2" (12.5 mm) | 10/40 |
| YT-2919 | 3/4" (19.0 mm) | 10/40 |
| YT-2920 | 1" (25.0 mm) | 10/40 |
| YT-2921 | 5/4" (32.0 mm) | 10/40 |

GB Pipe wrench
 D Rohrschlüssel
 PL Klucz do rur

RUS Ключ трубный
 CZ Klíč součásti na trubky

H Csőkulcs
 RO Cheie reglabila pt. tevi

E Llave para tubos
 CN 铝合金管钳



Al

| YATO | size / rozmiar | max. pipe diameter / max. średnica rury | |
|---------|----------------|---|------|
| YT-2482 | 14" (350 mm) | 2" (50 mm) | 6/12 |
| YT-2483 | 18" (450 mm) | 2.5" (63 mm) | 2/10 |
| YT-2484 | 24" (600 mm) | 3" (75 mm) | 2/6 |
| YT-2485 | 36" (900 mm) | 5" (125 mm) | 3 |

CrMo

| YATO | size / rozmiar | max. pipe diameter / max. średnica rury | |
|---------|----------------|---|------|
| YT-2488 | 10" (250 mm) | 1" (25 mm) | 6/18 |
| YT-2489 | 12" (300 mm) | 1.5" (38 mm) | 6/12 |
| YT-2490 | 14" (350 mm) | 2" (50 mm) | 2/10 |
| YT-2491 | 18" (450 mm) | 2.5" (63 mm) | 3/6 |
| YT-2492 | 24" (600 mm) | 3" (75 mm) | 2/4 |
| YT-2493 | 36" (900 mm) | 5" (125 mm) | 1 |
| YT-2494 | 48" (1200 mm) | 6" (150 mm) | 1 |
| YT-2495 | 60" (1500 mm) | 8" (200 mm) | 1 |

GB Pipe wrench
 D Rohrschlüssel
 PL Klucz do rur
 RUS Ключ трубный

CZ Klíč součásti na trubky
 H Csőkulcs
 RO Cheie reglabila pt. tevi

E Llave para tubos
 CN 铝合金管钳

OFFSET TYPE

GB Pipe wrench
 D Rohrschlüssel
 PL Klucz do rur
 RUS Ключ трубный

CZ Klíč součásti na trubky
 H Csőkulcs
 RO Cheie reglabila pt. tevi

E Llave para tubos
 CN 铝合金管钳

Al HANDLE



| YATO | size / rozmiar | max. pipe diameter / max. średnica rury | |
|---------|----------------|---|------|
| YT-2201 | 10" (250 mm) | 1" (25 mm) | 6/36 |
| YT-2203 | 14" (350 mm) | 1.5" (38 mm) | 4/16 |
| YT-2204 | 18" (450 mm) | 2" (50 mm) | 3/12 |
| YT-2205 | 24" (600 mm) | 2.5" (63 mm) | 3/6 |
| YT-2206 | 36" (900 mm) | 4" (100 mm) | 2/4 |

| YATO | size / rozmiar | max. pipe diameter / max. średnica rury | |
|---------|----------------|---|------|
| YT-2222 | 12" (300 mm) | 1" (25 mm) | 6/24 |
| YT-2223 | 14" (350 mm) | 1.5" (38 mm) | 4/16 |
| YT-2224 | 18" (450 mm) | 2" (50 mm) | 3/12 |
| YT-2225 | 24" (600 mm) | 2.5" (63 mm) | 3/6 |

GB Adjustable pipe wrench
D Rohrschlüssel
PL Klucz nastawny do rur



RUS Ключ трубный переставной
CZ Nastavitelný klíč na trubky
H Állítható csőkulcs

RO Cheie reglabilă pt. tevi
E Llave para tubos tipo Inglesa
CN 鹰嘴钳

COLOR BOX

| | | | |
|----------|------|----------|------|
| 90° | 1" | 1.5" | 2" |
| | 25mm | 38mm | 50mm |
| DIN 5234 | | CrV 6140 | |



| YATO  | max. pipe diameter / max. średnica rury | L (mm) |  |
|--|---|--------|---|
| YT-2210 | 1" (25 mm) | 320 | 24 |
| YT-2211 | 1.5" (38 mm) | 420 | 18 |
| YT-2212 | 2" (50 mm) | 560 | 12 |

GB Adjustable pipe wrench
D Rohrschlüssel
PL Klucz nastawny do rur



RUS Ключ трубный переставной
CZ Nastavitelný klíč na trubky
H Állítható csőkulcs

RO Cheie reglabilă pt. tevi
E Llave para tubos tipo Inglesa
CN 鹰嘴钳

COLOR BOX

| | | | |
|----------|------|----------|------|
| 45° | 1" | 1.5" | 2" |
| | 25mm | 38mm | 50mm |
| DIN 5234 | | CrV 6140 | |



| YATO  | max. pipe diameter / max. średnica rury | L (mm) |  |
|--|---|--------|---|
| YT-2213 | 1" (25 mm) | 330 | 24 |
| YT-2214 | 1.5" (38 mm) | 415 | 18 |
| YT-2215 | 2" (50 mm) | 530 | 12 |

GB Adjustable pipe wrench
D Rohrschlüssel
PL Klucz nastawny do rur



RUS Ключ трубный переставной
CZ Nastavitelný klíč na trubky
H Állítható csőkulcs

RO Cheie reglabilă pt. tevi
E Llave para tubos tipo Inglesa
CN 鹰嘴钳

COLOR BOX

| | | | |
|----------|------|----------|------|
| S | 1" | 1.5" | 2" |
| | 25mm | 38mm | 50mm |
| DIN 5234 | | CrV 6140 | |



| YATO  | max. pipe diameter / max. średnica rury | L (mm) |  |
|--|---|--------|---|
| YT-2216 | 1" (25 mm) | 330 | 24 |
| YT-2217 | 1.5" (38 mm) | 420 | 18 |
| YT-2218 | 2" (50 mm) | 535 | 12 |

GB Chain pipe wrench
D Kettenrohrzange
PL Klucz łańcuchowy do rur
RUS Ключ цепной для труб
CZ Klíč řetězový na trubky
H Láncos csőfogó
RO Cheie reglabilă pt. tevi cu lanț
E Llave de cadena
CN 链条管子钳



SLIDING CARD



| | |
|--|---|
| 300 mm | 4" |
| $\varnothing 100$ mm | $\varnothing 100$ mm |
| INDUCTION HARDENED TEETH ZĘBY HARTOWANE INDUKCYJNIE | ADJUSTABLE WORKING RANGE REGULOWANY ZAKRES PRACY |

| YATO  | L (mm) | max. pipe diameter / max. średnica rury |  |
|--|--------|---|---|
| YT-22260 | 300 | 4" (100 mm) | 6/24 |

GB Adjustable pliers
D Verstellbare Kombizange
PL Szczypce przestawne
RUS Переставные клещи
CZ Kleště přestavitelné

H Állítható fogó
RO Cleste pivot
E Pinzas ajustables
CN 鲤鱼钳

HALF DOUBLE BLISTER



150 mm
HRC 45-55





| YATO  | L (mm) | max. working range / max. rozstaw (mm) |  |
|--|--------|--|---|
| YT-1957 | 150 | 65-70 | 6/60 |

GB Water pump pliers
D Wasserpumpenzange
PL Szczypce nastawne
RUS Клещи переставные
CZ Keleště siko

H Vízpumpafagó
RO Cleste papagal
E Alicates de fontanero ajustables
CN 水泵钳

250 mm 300 mm CrV



| YATO  | L (mm) |  |
|--|--------|---|
| YT-2090 | 250 | 6/36 |
| YT-2091 | 300 | 6/36 |

GB Water pump pliers
D Wasserpumpenzange
PL Szczypce nastawne
RUS Клещи переставные
CZ Keleště siko



H Vízpumpafagó
RO Cleste papagal
E Alicates de fontanero ajustables
CN 水泵钳

HALF DOUBLE BLISTER





250 mm
NICKEL IRON FINISH



| YATO  | L (mm) |  |
|--|--------|---|
| YT-2069 | 250 | 6/36 |



| YATO  | L (mm) |  |
|--|--------|---|
| YT-2070 | 250 | 6/24 |

GB PVC pipe cutter
 D PVC Rohrschneider
 PL Obcinak do rur PCV
 RUS Труборез для ПВХ труб
 CZ Rezač PVC trubek

H Csővágó olló PVC csövekhez
 RO Clește pt. tăiat țevi din PVC
 E Cortatubos PVC
 CN PVC 管子割刀

SLIDING CARD



AUTOMATIC

| | | |
|-------------|-------------|------|
| YATO | max. Ø (mm) | |
| YT-2230 | 35 | 6/48 |

| | | |
|-------------|-------------|------|
| YATO | max. Ø (mm) | |
| YT-2231 | 42 | 6/48 |



Al

Al

| | | |
|-------------|-------------|------|
| YATO | max. Ø (mm) | |
| YT-2228 | 51 | 6/24 |

| | | |
|-------------|-------------|------|
| YATO | max. Ø (mm) | |
| YT-2229 | 64 | 6/24 |

GB Pipe cutter
 D Rohrschneider
 PL Obcinak do rur
 RUS Труборез для труб
 CZ Rezač trubek
 H Csővágó olló csövekhez
 RO Clește pt. tăiat țevi
 E Cortatubos
 CN 管子割刀

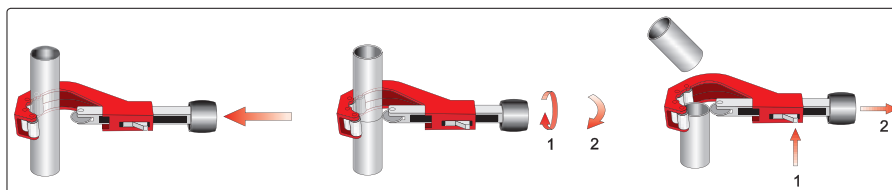

COLOR BOX



11



Ø 3/8"-1-5/8"
 Ø 10-40 mm

WITH DEBURRER
 Z GRATOWNIKIEM

Ø 1/4"-7/4"
 Ø 6-45 mm

| | | |
|-------------|------------------------|----|
| YATO | Ø | |
| YT-2232 | 3/8"-1-5/8" (10-40 mm) | 20 |

| | | |
|-------------|---------------------|----|
| YATO | Ø | |
| YT-2233 | 1/4"-7/4" (6-45 mm) | 25 |



QUICK-ADJUSTMENT
 SZYBKONASTAWNY

Ø 1/2"-5/2"
 Ø 14-63 mm

QUICK-ADJUSTMENT
 SZYBKONASTAWNY

Ø 2"-5"
 Ø 50-127 mm

| | | |
|-------------|----------------------|----|
| YATO | Ø | |
| YT-2234 | 1/2"-5/2" (14-63 mm) | 25 |

| | | |
|-------------|-------------------|----|
| YATO | Ø | |
| YT-2235 | 2"-5" (50-127 mm) | 10 |

- GB Hand flaring tools set
D Handpresse zum Aufweiten von Rohren
PL Praska do ręcznego rozszerzania rur
RUS Пресс для ручного расширения труб
CZ Přípravek na ruční rozšířování konců trubek
H Kézi csőtágító
RO Presă manuală pt. lățirea țevilor
E Prensa para la elongación manual de tubos
CN 扩孔器组套

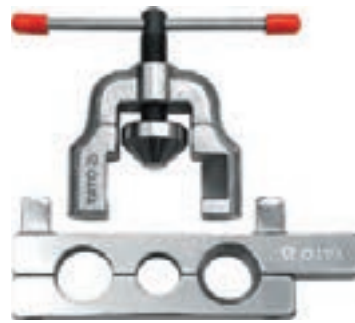

2
PCS

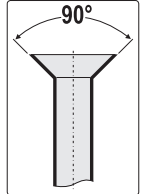

COLOR BOX



| YATO | Ø (mm) | |
|---------|------------|----|
| YT-2182 | 22; 25; 28 | 20 |

- GB Hand flaring tools set
D Handpresse zum Aufweiten von Rohren
PL Praska do ręcznego rozszerzania rur
RUS Пресс для ручного расширения труб
CZ Přípravek na ruční rozšířování konců trubek
H Kézi csőtágító
RO Presă manuală pt. lățirea țevilor
E Prensa para la elongación manual de tubos
CN 扩孔器组套



7
PCS

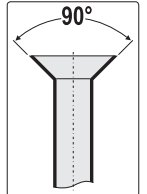

BMC & COLOR
SLEEVE



| YATO | Ø (mm) | |
|---------|------------------------------------|----|
| YT-2180 | 3; 5; 6; 8; 10; 12; 14; 15; 16; 19 | 10 |

- GB Hand flaring tools set
D Zange zum Aufweiten von Rohrenden von Hand
PL Szczypce do kielichowania ręcznego
RUS Щипцы для формирования раструбов вручную
CZ Kleště na ruční hrdlování konců trubek
H Csőtágító fogó
RO Clește pt. manșonare manuală
E Pinzas para abocinamiento manual de tubos
CN 扩孔器组套



7
PCS

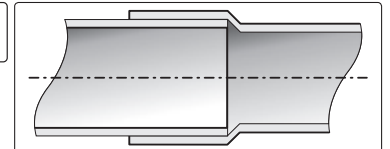

BMC
& COLOR
SLEEVE



| YATO | size / rozmiar | |
|---------|---|---|
| YT-2183 | 1/2" (12.7 mm); 5/8" (15.9 mm); 3/4" (19.0 mm); 7/8" (22.2 mm); 1" (25.4 mm); 9/8" (28.6 mm) | 5 |

- GB Hinged pipe vice
D Rohrschraubstock
PL Imadło zaciskowe do rur
RUS Тиски для труб
CZ Upinací svěrák na trubky
H Satu, csőszorító
RO Menghină pt. țevi
E Tornillo de apriete para tubos
CN 管子台虎钳



S55C

COLOR BOX



| YATO | Ø (mm) | |
|---------|--------|---|
| YT-6510 | 60 | 4 |
| YT-6511 | 76 | 2 |
| YT-6512 | 90 | 2 |
| YT-6513 | 110 | 1 |

12

Fastening tools Narzędzia do łączenia



Hand riveters & rivets
Nitownice ręczne i nity

214-216



| | |
|---|-----|
| Hand riveters Nitownice ręczne..... | 214 |
| Lazy tong riveters Nitownice ręczne, dźwigniowe..... | 214 |
| Hand nut tools Nitownice do nitonakrętek..... | 215 |
| Aluminium blind rivets Nity aluminiowe..... | 216 |

Pneumatic riveters
Nitownice pneumatyczne

216



Staple guns & staples
Zszywacze i zszywki

217



| | |
|-------------------------------------|-----|
| Staple guns Zszywacze..... | 217 |
| Staple removers Rozszywacze..... | 217 |
| Staples Zszywki..... | 217 |
| Nails Gwoździe..... | 217 |

Pneumatic stitching & nailing machines
Zszywacze i gwoździarki pneumatyczne

218-219



| | |
|--|-----|
| Pneumatic staplers Zszywacze pneumatyczne..... | 218 |
| Pneumatic nailers Gwoździarki pneumatyczne..... | 218 |
| Staples Zszywki..... | 219 |
| Nails Gwoździe..... | 219 |

Mini palm nailers
Młotki pneumatyczne do gwoździ

219



Gas framing nailers & accessories
Gwoździarki gazowe i akcesoria

219



Foam guns
Pistolety do pianki

220



Caulking guns
Wyciskacze do mas

220-221



Burners & soldering tools
Palniki i lutownice

221-222



Glue guns
Pistolety do klejenia

222



- GB Hand riveter
 D Blindnietzange
 PL Nitownica ręczna
 RUS Заклепочник
 CZ Ruční nýtovačka
 H Kézi popszegecshúzó
- RO Presă de nituit manuală
 E Remachadora de mano
 CN 拉铆枪

DOUBLE BLISTER



| YATO | Ø (mm) | L (mm) | |
|---------|--------------------|--------|------|
| YT-3600 | 2.4; 3.2; 4.0; 4.8 | 280 | 6/24 |

| YATO | Ø (mm) | L (mm) | |
|---------|--------------------|--------|------|
| YT-3601 | 2.4; 3.2; 4.0; 4.8 | 250 | 6/24 |

- GB Hand riveter
 D Blindnietzange
 PL Nitownica ręczna
 RUS Заклепочник
 CZ Ruční nýtovačka
- H Kézi popszegecshúzó
 RO Presă de nituit manuală
 E Remachadora de mano
 CN 拉铆枪

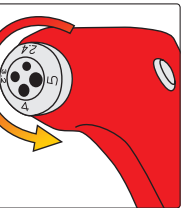

COLOR BOX



- GB Hand riveter
 D Blindnietzange
 PL Nitownica ręczna z głowicą obrotową
 RUS Заклепочник
 CZ Ruční nýtovačka
 H Kézi popszegecshúzó
 RO Presă de nituit manuală
 E Remachadora de mano
 CN 拉铆枪



SLIDING CARD



| YATO | Ø (mm) | L (mm) | |
|----------|--------------------|--------|----|
| YT-36012 | 2.4; 3.2; 4.0; 4.8 | 200 | 30 |

| YATO | Ø (mm) | L (mm) | |
|----------|--------------------|--------|-------|
| YT-36011 | 2.4; 3.2; 4.0; 4.8 | 253 | 12/36 |

- GB Lazy tongue riveter
 D Blindnietzange
 PL Nitownica dźwigniowa
 RUS Заклепочник
 CZ Nýtovačka páková
 H Emelyűs popszegecshúzó
- RO Pcleşte pt. popnituri
 E Remachadora de palanca
 CN 双把手拉铆枪



| YATO | Ø (mm) | L (mm) | |
|---------|-------------------------|--------|----|
| YT-3609 | 3.2; 4.0; 4.8; 6.0; 6.4 | 330 | 16 |

- GB Lazy tongue riveter
 D Blindnietzange
 PL Nitownica dźwigniowa z głowicą obrotową
 RUS Заклепочник
- CZ Nýtovačka páková
 H Emelyűs popszegecshúzó
 RO Pcleşte pt. popnituri
 E Remachadora de palanca
 CN 拉铆枪

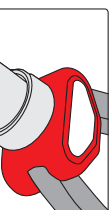

COLOR BOX



| YATO | Ø (mm) | L (mm) | |
|----------|--------------------|--------|----|
| YT-36092 | 3.2; 4.0; 4.8; 6.4 | 328 | 12 |

GB Lazy tongue riveter
D Blindnietzange
PL Nitownica dźwigniowa
RUS Заклепочник
CZ Nýtovačka páková

H Emeltyűs popszegecshúzó
RO Pcleşte pt. popnituri
E Remachadora de palanca
CN 拉铆枪

380
mm

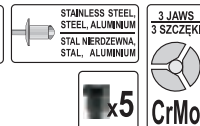

COLOR BOX

| YATO | Ø (mm) | L (mm) | Box |
|----------|-------------------------|--------|-----|
| YT-36095 | 2.4; 3.2; 4.0; 4.8; 6.4 | 380 | 12 |

GB Lazy tongue riveter
D Blindnietzange
PL Nitownica dźwigniowa
RUS Заклепочник
CZ Nýtovačka páková

H Emeltyűs popszegecshúzó
RO Pcleşte pt. popnituri
E Remachadora de palanca
CN 双把手拉铆枪

525
mm



COLOR BOX

| YATO | Ø (mm) | L (mm) | Box |
|---------|-------------------------|--------|-----|
| YT-3610 | 3.2; 4.0; 4.8; 6.0; 6.4 | 525 | 12 |

GB Hand nut tool
D Blindnietzange
PL Nitownica ręczna do nitonakrętek
RUS Заклепочник
CZ Nýtovačka páková

H Emeltyűs popszegecshúzó
RO Pcleşte pt. popnituri
E Remachadora de palanca
CN 手动铆螺母枪

0~8
mm



COLOR BOX

| YATO | size / rozmiar | L (mm) | Box |
|---------|---------------------|--------|-----|
| YT-3613 | M4; M5; M6; M8; M10 | 440 | 10 |

GB Hand nut tool
D Blindnietzange
PL Nitownica ręczna do nitonakrętek

RUS Заклепочник
CZ Nýtovačka páková
H Emeltyűs popszegecshúzó
RO Pcleşte pt. popnituri
E Remachadora de palanca
CN 双把手螺母枪

330
mm



BMC & COLOR SLEEVE

| YATO | size / rozmiar | L (mm) | Box |
|---------|----------------------|--------|-----|
| YT-3612 | M5; M6; M8; M10; M12 | 330 | 5 |

GB Hand nut tool
D Blindnietzange
PL Nitownica ręczna do nitonakrętek
RUS Заклепочник
CZ Nýtovačka páková

H Emeltyűs popszegecshúzó
RO Pcleşte pt. popnituri
E Remachadora de palanca
CN 铆螺母枪



x5

338 mm

STAINLESS STEEL, STEEL, ALUMINIUM, STAL, NIERDZEWNIA, STAL, ALUMINIUM



| YATO | size / rozmiar | L (mm) | |
|----------|----------------------|--------|---|
| YT-36119 | M5; M6; M8; M10; M12 | 338 | 6 |

GB Hand nut tool
D Blindnietzange
PL Nitownica ręczna do nitonakrętek
RUS Заклепочник
CZ Nýtovačka páková

H Emeltyűs popszegecshúzó
RO Pcleşte pt. popnituri
E Remachadora de palanca
CN 铆螺母枪



410 mm

x7

STAINLESS STEEL, STEEL, ALUMINIUM, STAL, NIERDZEWNIA, STAL, ALUMINIUM



| YATO | size / rozmiar | L (mm) | |
|----------|------------------------------|--------|---|
| YT-36129 | M3; M4; M5; M6; M8; M10; M12 | 410 | 5 |

GB Aluminium blind rivets
D Aluminiumblindnieten
PL Nity aluminiowe

RUS Алюминиевые заклёпки
CZ Hliníkové nýty
H Alu popszegecs

RO Nituri din aluminiu
E Remaches de aluminio
CN K型抽芯铝铆钉



DOUBLE BLISTER



50 PCS
Al

| YATO | Ø (mm) | L (mm) | PCS packing | |
|---------|--------|--------|-------------|-------|
| YT-3630 | 3.2 | 6.4 | 50 | 12/48 |
| YT-3631 | 3.2 | 9.6 | 50 | 12/48 |
| YT-3634 | 4.0 | 6.4 | 50 | 12/48 |
| YT-3635 | 4.0 | 9.6 | 50 | 12/48 |
| YT-3636 | 4.0 | 12.7 | 50 | 12/48 |

| YATO | Ø (mm) | L (mm) | PCS packing | |
|---------|--------|--------|-------------|-------|
| YT-3637 | 4.0 | 19.0 | 50 | 12/48 |
| YT-3639 | 4.8 | 6.4 | 50 | 12/48 |
| YT-3640 | 4.8 | 9.6 | 50 | 12/48 |
| YT-3641 | 4.8 | 12.7 | 50 | 12/48 |
| YT-3642 | 4.8 | 19.0 | 50 | 12/48 |

12

GB Pneumatic riveting machine
D Pneumatische Nietvorrichtung
PL Nitownica pneumatyczna
RUS Пневматический заклепочник
CZ Pneumatická nýtovačka

H Pneumatikus popszegecshúzó
RO Presa pneumatica de nituti
E Máquina remachadora
CN 气动拉铆枪

COLOR BOX



STAINLESS STEEL, STEEL, ALUMINIUM, STAL, NIERDZEWNIA, STAL, ALUMINIUM

1/4" 6.3 mm

0.62 MPa



x4 • application: industry
• przeznaczenie: przemysł

x5 • application: industry
• przeznaczenie: przemysł

| YATO | Ø (mm) | L (mm) | F (kg) | F (N) | |
|---------|--------------------|--------|--------|-------|----|
| YT-3617 | 2.4; 3.2; 4.0; 4.8 | 14 | 850 | 8335 | 10 |

| YATO | Ø (mm) | L (mm) | F (kg) | F (N) | |
|---------|-------------------------|--------|--------|-------|---|
| YT-3618 | 2.4; 3.2; 4.0; 4.8; 6.4 | 16 | 1389 | 13620 | 6 |

- GB Staple gun
D Tacker
PL Zszywacz tapicerski
RUS Стенпеп
CZ Čalounická sešivačka
H Kárpitos tűzőgép
RO Capsator tapiterie
E Grapadora de tapicero
CN 打钉枪

DOUBLE
BLISTER

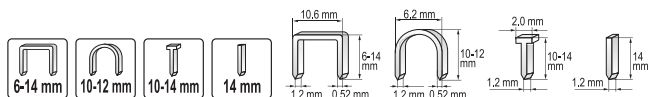
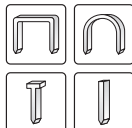

YATO

YT-7000

12/24

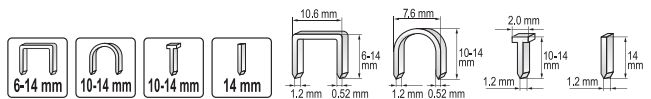

YATO

YT-7001

12/24

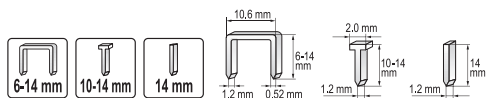

YATO

YT-7003

6/24

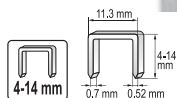

YATO

YT-7007

12/24

- GB Staple gun
D Tacker
PL Zszywacz tapicerski
RUS Стенпеп
CZ Čalounická sešivačka
H Kárpitos tűzőgép

- RO Capsator tapiterie
E Grapadora de tapicero
CN 打钉枪

NORMAL-MAX IMPACT FUNCTION



DOUBLE
BLISTER

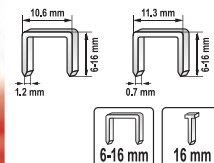

YATO

staples size / rozmiar zszywek (mm)

YT-7005

10.6x6.0-16.0x1.2

6/24

- GB Hammer tacker
D Hammer-Tacker
PL Zszywacz młotkowy

- RUS Стенпеп
CZ Čalounická sešivačka
H Kárpitos tűzőgép

- RO Capsator tapiterie
E Grapadora de martillo
CN 钉锤

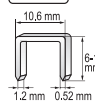

DOUBLE
BLISTER

YATO

YT-7004

10/20

- GB Staple remover
D Klammern abwender
PL Rozszywacz
RUS Скобоудалитель
CZ Rozešivač
H Kapocsiszedő
RO Extractor capse
E Quitagrapas



SLIDING
CARD

YATO

YT-7011

25/100

- GB Staples
D Heftklammern
PL Zszywki

- RUS Скобы
CZ Sešivky
H Tűzőkapocs

- RO Capse tapiterie
E Grapas
CN 码钉

HANGING
COLOR
BOX

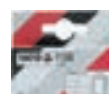

for / dla: YT-7000, YT-7001,
YT-7003, YT-7004, YT-7005

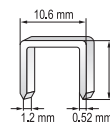

for / dla: YT-7006, YT-7007

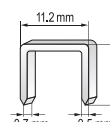

- GB Nails for staple gun
D Nageln für Yato Tacker
PL Gwoździe do zszywacza
RUS Гвозди для стенпепера
CZ Hřebíky na sešivačku
H Szegeka tűzőgéphez
RO Cuie pt. capsator
E Clavos para grapadoras
CN 直钉



HANGING
COLOR
BOX

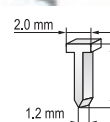
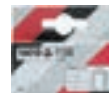

YATO

YT-7032

10

1000

50/200

YT-7033

12

1000

50/200

YT-7034

14

1000

50/200

for / dla: YT-7000, YT-7001

GB Pneumatic stitching machine
 D Drucklufthefter
 PL Zszywacz pneumatyczny
 RUS Пневматический шиватель
 CZ Pneumatická sešivačka
 H Pneumatikus tűzőgép
 RO Capsator pneumatic
 E Engrapadora pneumática
 CN 气动码钉枪

7 bar 8-25 mm 1/4" 6.3mm

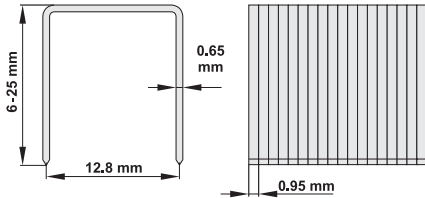

- application: industry, construction
- przeznaczenie: przemysł, budownictwo

BMC & COLOR SLEEVE



| | |
|-------------|---|
| YATO | |
| YT-0920 | 5 |

GB Pneumatic nailing machine
 D Druckluftnagelgerät
 PL Gwoździarka pneumatyczna
 RUS Пневматическая гвоздильная машина
 CZ Pneumatický nastřelovač hřebíků
 H Pneumatikus szögbelővő
 RO Capsator pneumatic
 E Máquina pneumática para clavar clavos
 CN 气动码钉枪

8 bar 25-64 mm 90° 1/4" 6.3mm

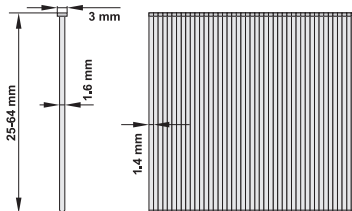

- application: industry, construction
- przeznaczenie: przemysł, budownictwo

BMC & COLOR SLEEVE



| | |
|-------------|---|
| YATO | |
| YT-0921 | 5 |

GB Pneumatic nailing machine
 D Druckluftnagelgerät
 PL Gwoździarka pneumatyczna
 RUS Пневматическая гвоздильная машина
 CZ Pneumatický nastřelovač hřebíků
 H Pneumatikus szögbelővő
 RO Capsator pneumatic
 E Máquina pneumática para clavar clavos
 CN 气动码钉枪

8 bar 50-90 mm 34° 1/4" 6.3mm

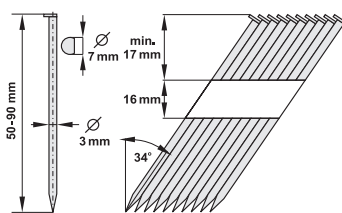

- application: industry, construction
- przeznaczenie: przemysł, budownictwo

BMC & COLOR SLEEVE



| | |
|-------------|---|
| YATO | |
| YT-0923 | 2 |

GB Staples
D Heftklammern
PL Zszywki
RUS Сшивки
CZ Spony
H Tűzőkarocs
RO Capse
E Grapas
CN 码钉

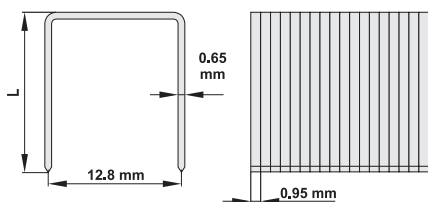

for / dla: YT-0920 COLOR BOX

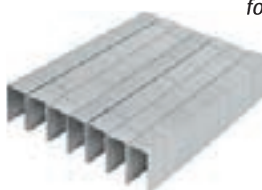

1000
PCS

| YATO | L (mm) | |
|---------|--------|-----|
| YT-0930 | 8 | 100 |
| YT-0931 | 16 | 50 |
| YT-0932 | 25 | 50 |

GB Nails
D Nägel
PL Gwoździe
RUS Гвозди
CZ Hřebíky

H Szeg
RO Cuie
E Clavos
CN 直钉

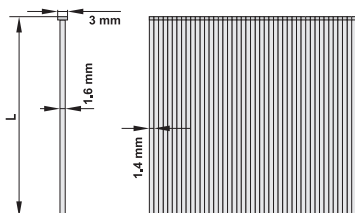

for / dla: YT-0921

1000
PCS 90°

COLOR BOX



| YATO | L (mm) | |
|---------|--------|----|
| YT-0941 | 50 | 20 |
| YT-0942 | 64 | 20 |

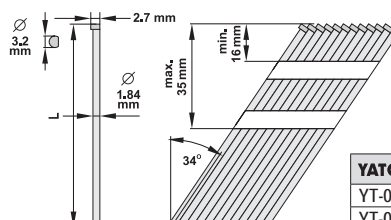

1000
PCS 34°

for / dla: YT-0922
COLOR BOX



| YATO | L (mm) | |
|---------|--------|----|
| YT-0938 | 38 | 20 |
| YT-0939 | 50 | 20 |
| YT-0940 | 64 | 20 |

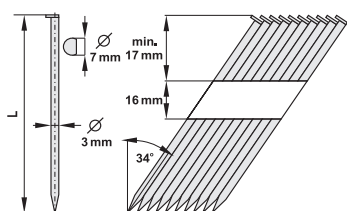

for / dla: YT-0923, YT-0927

500
PCS 34°

COLOR BOX



| YATO | L (mm) | |
|---------|--------|----|
| YT-0935 | 50 | 10 |
| YT-0936 | 75 | 10 |
| YT-0937 | 90 | 10 |

GB Mini palm nailer
D Drucklufthammer für nagel
PL Młotek pneumatyczny do gwoździ
RUS Пневматический молоток для забивания гвоздей
CZ Pneumatická hřebíkovačka
H Pneumatikus szögbeütő kalapács
RO Ciocan pneumatic pt. cuie
E Maquina pneumática para clavar clavos
CN 迷你气动钉枪

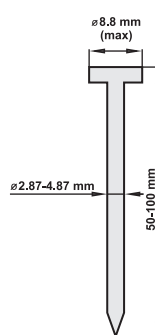

0.70
MPa 1/4"

6.3 mm

COLOR BOX



| YATO | |
|---------|----|
| YT-0925 | 20 |

GB Gas framing nailer
D Gas-nagler
PL Gwoździarka gazowa
RUS Газовая гвоздильная машина
CZ Plynová nastřelovačka hřebíků

H Gáztechnológiás szögbeütő
RO Capsator cu gaz
E Clavadora de gas
CN 瓦斯钉枪

42 bar 4000l 50-90 mm 40 g 80 ml 1200l TRIGGER LOCK BLOKADA SPUSTU

GB Gas pipe
D Gaspatrone
PL Tuba gazowa
RUS Баллончик с газом
CZ Plynová bombička
H Gáz patron
RO Recipient cu gaz
E Tubo de gas
CN 瓦斯管配件

40 g 80 ml FUEL CELL FOR NAILERS GAZ DO GWOŹDZIAREK

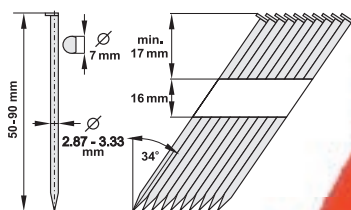

fits to / pasuje do:
YATO, PASLODE,
HITACHI, SENCO,
POWERS, MAX, BEA

| YATO | |
|---------|---|
| YT-0927 | 2 |

| YATO | |
|---------|-----|
| YT-0929 | 120 |

BMC & COLOR SLEEVE



GB Foam gun
D Farbspritzpistole
PL Pistolet do pianki montażowej
RUS Пистолет для нанесения полиуретановой пены
CZ Pistole na montážní pěnu

H Felrakó pisztoly, poliurethán habhoz
RO Pistol pt. spumă

E Pistola para espuma de montaje de metalo
CN 发泡枪

COLOR BOX

PTFE COATED



YATO   YT-6740 10/20

YATO   YT-6741 10/20



YATO   YT-6742 10/20

YATO   YT-6743 20



YATO   YT-6744 20

YATO   YT-6745 20

12

GB Caulking gun
D Kartuschenpistole
PL Wyciskacz do mas



RUS Пистолет для герметика
CZ Protlačovač na hmoty
H Masszakinyomó



RO Pistol silicon
E Pistola para masilla
CN 堵缝枪

225 mm



300 ml





YATO  L (mm)  YT-6751 225 10/20

YATO  L (mm)  YT-6752 225 10/20



YATO  L (mm)  YT-6753 225 6/12

YATO  L (mm)  YT-6754 225 10/20

GB Caulking gun
D Kartuschenpistole
PL Wyciskacz do mas

RUS Пистолет для герметика
CZ Protláčovač na hmoty
H Masszakingyomó

RO Pistol silicon
E Pistola para masilla
CN 堵缝枪

300 ml



225 mm

225 mm

| | | |
|-------------|--------|-------|
| YATO | L (mm) | |
| YT-6750 | 225 | 20/40 |

| | | |
|-------------|--------|-------|
| YATO | L (mm) | |
| YT-6755 | 225 | 10/20 |



216 mm
±60 mm

200 mm
±65 mm

| | | |
|-------------|--------|------|
| YATO | L (mm) | |
| YT-6756 | 215 | 6/12 |

| | | |
|-------------|--------|-------|
| YATO | L (mm) | |
| YT-6757 | 200 | 10/20 |

GB Butane torch
D Gasbrenner
PL Palnik gazowy
RUS Газовая горелка
CZ Plynový hořák
H Gázégő
RO Arzător de gaz
E Soplete de gas
CN 火焰枪

PIEZO ELECTRIC
1350°C
60 ml
200 min



HANGING
COLOR BOX



| | |
|-------------|------|
| YATO | |
| YT-6700 | 6/24 |

GB Butane soldering tool
D Gaslötkolben
PL Lutownica gazowa
RUS Паяльник газовый
CZ Plynová pájka

H Forrasztópisztoly ceruza
bután gáz üzemű
RO Surubelnita sudura cu gaz
E Microsoldador de butano portátil
CN 瓦斯焊接工具

SLIDING
CARD



1300°C
210-400°C
20 ml
25-80 W
120 min

| | | |
|-------------|-------|-------|
| YATO | W | |
| YT-6705 | 25-80 | 12/72 |



PIEZO ELECTRIC
1300°C
250-550°C
38 ml
30-125 W
200 min

| | | |
|-------------|--------|-------|
| YATO | W | |
| YT-6706 | 30-125 | 12/48 |

GB Soldering iron
D LötKolben
PL Lutownica oporowa
RUS Электропаяльник
CZ Pájka odporová
H Forrasztópáka
RO Ciocan de lipit
E Soldador de resistencia
CN 电烙铁

HANGING
DISPLAY
COLOR BOX

230V~
50Hz



| YATO | W | working temp. of soldering tip (°C) | dimensions of soldering tip (mm) | |
|---------|----|-------------------------------------|----------------------------------|----|
| YT-8271 | 30 | 400 | ø3.8 x 70 | 16 |
| YT-8272 | 60 | 500 | ø6.0 x 78 | 16 |
| YT-8273 | 80 | 520 | ø6.8 x 64 | 16 |

GB Desoldering pump
D Entlötsaugpumpe
PL Odsysacz do cyny
RUS Шприц для удаления припоя
CZ Odprájecí sací pumpa
H Ónszippantó
RO Pompa fludor
E Bomba desoldadora
CN 全铝手动吸锡器

SLIDING
CARD

PTFE
TIP



| YATO | |
|----------|---------|
| YT-82742 | 100/400 |



| YATO | |
|----------|---------|
| YT-82743 | 100/200 |



| YATO | |
|----------|--------|
| YT-82744 | 50/100 |

GB Transformer soldering gun
D Lötpestole
PL Lutownica transformatorowa
RUS Паяльник электрический
CZ Transformátorová páječka
H Forrasztópáka
RO Aparat de lipit letcon cu transformator
E Soldador transformador
CN 电烙铁

230V~
50Hz

180
W

LED



BMC
& COLOR
SLEEVE

| YATO | W | |
|---------|-----|----|
| YT-8245 | 180 | 10 |

GB Electric glue gun
D Heissklebepistole
PL Pistolet do klejenia
RUS Пистолет для клея
CZ Pistole na lepení
H Ragasztópisztoly
RO Pistol pt. lipit
E Pistola de cola
CN 热胶枪

230V~
50Hz

35
(400)
W

11 mm



COLOR
BOX



| YATO | W | |
|----------|----------|-------|
| YT-82401 | 35 (400) | 12/24 |

GB Cordless glue gun
D Heissklebepistole
PL Akumulatorowy pistolet do klejenia
RUS Пистолет для клея
CZ Pistole na lepení
H Ragasztópisztoly
RO Pistol pt. lipit
E Pistola de cola
CN 热胶枪

7.4 V
2.6 Ah
Li-Ion

Li-Ion

8W

11 mm



DOUBLE
BLISTER



| YATO | W | |
|----------|---|------|
| YT-82421 | 8 | 6/24 |

Memo

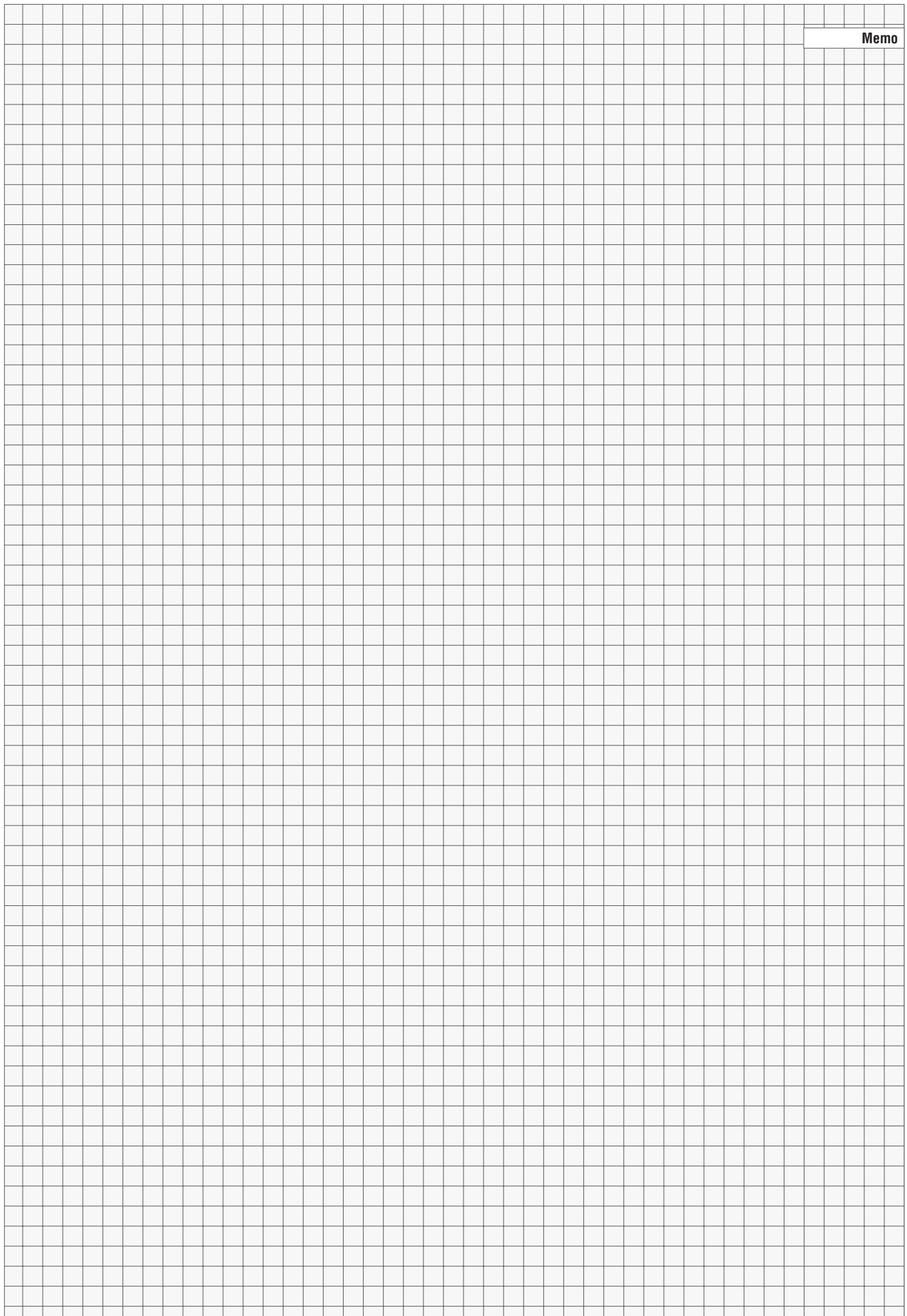

13

Construction tools Narzędzia budowlane



Floor laminate cutters
Gilotyny do cięcia paneli podłogowych

226



Floating rules
Łaty

235



Tile cutting machines & accessories
Przyrządy do cięcia glazury i akcesoria

226-228



Knives
Noże

236



Profile gauges
Wzorniki profili

229



Electric hoists
Elektryczne wciągarki linowe

236



Scrapers
Szpachelki

229



Extension cords
Przedłużacze elektryczne

237



Masonry tools
Narzędzia tynkarskie i murarskie

230-232



Mixers
Mieszadła

238



Floats
Pace..... 230
Trowels
Kielnie..... 232
Plaster scrubbers
Żdzieraki do tynków..... 232

Pencils
Ołówki..... 238-239



Roofwork tools
Narzędzia dekarские

233-235



Carpenter's pencils
Ołówki stolarskie..... 238
Masonry pencils
Ołówki murarskie..... 238

- GB Floor laminate cutter
- D Laminat-Schneider
- PL Gilotyina do cięcia paneli podłogowych
- RUS Гильотина для ламината
- CZ Nůžky na laminátové plovoucí podlahy
- H Laminált padló vágógép
- RO Aparat de taiat parchet laminat
- E Guillotina cortapaneles
- CN 木地板切割器

| | |
|---------------------------|---|
| CARBON STEEL STAL WĘGLOWA | 12 max. CUTTING THICKNESS mm GRUBOŚĆ CIĘCIA |
| ZINC PLATED CYNKOWANE | 205 max. CUTTING LENGTH mm DŁUGOŚĆ CIĘCIA |

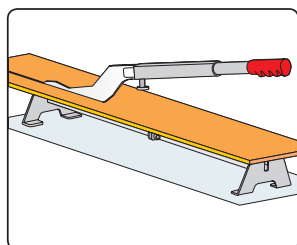
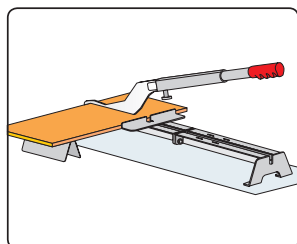
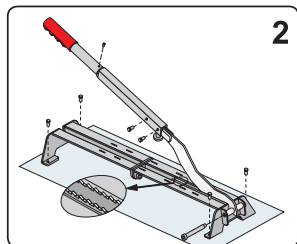
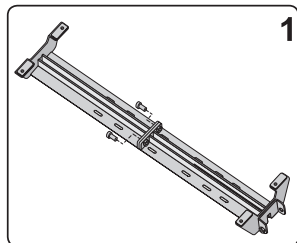

| | | |
|-------------|--|---|
| YATO | | |
| YT-3730 | | 4 |

13

- GB Tile cutting machine
- D Fliesenschnidmaschine
- PL Przyrząd do cięcia glazury
- RUS Плиткорез
- CZ Přístroj na řezání glazury
- H Csempevágó
- RO Instrument de tăiere a glazurei
- E Cortadora de gres
- CN 瓷砖切割器

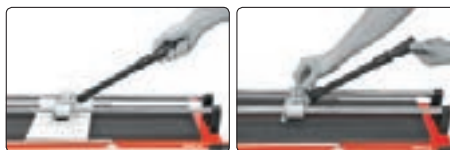

| | | |
|---|--------------------------------|-----------|
| CUTTING CIĘCIE ±45° | 14 mm (max) COATED TiN POWŁOKA | 22x6x2 mm |
| YG6X TUNGSTEN CARBIDE TIP OSTRZE Z WĘGLIKĄ WOLFRAMU | | |



| | | |
|-------------|--------|---|
| YATO | L (mm) | |
| YT-3700 | 400 | 2 |
| YT-3701 | 600 | 2 |
| YT-3702 | 700 | 2 |

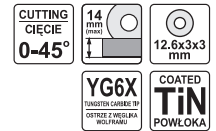

GB Tile cutting machine
D Fliesenschnidmaschine
PL Przystroj do cięcia glazury
RUS Плиткорез
CZ Přístroj na řezání glazury

H Csempevágó
RO Instrument de tăiere a glazurei
E Cortadora de gres
CN 瓷砖切割器



COLOR BOX



| YATO  | L (mm) |  |
|--|--------|---|
| YT-3703 | 630 | 2 |

GB Tile cutting wheel
D Schneiderrad
PL Kółko tnące wymienne

RUS Ролик для плиткореза
CZ Výměnné kolečko
H Cseregőrgő csavarral

RO Cuițit rolă
E Recambio de cuchillo redondo
CN 硬质合金刀片

SLIDING CARD



for / dla: YT-3700, YT-3701, YT-3702



for / dla: YT-3703



| YATO  |  |
|--|---|
| YT-3712 | 50/250 |

| YATO  |  |
|--|---|
| YT-3713 | 50/200 |

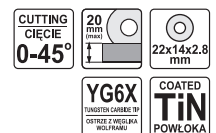

GB Tile cutting machine
D Fliesenschnidmaschine
PL Przystroj do cięcia glazury
RUS Плиткорез
CZ Přístroj na řezání glazury

H Csempevágó
RO Instrument de tăiere a glazurei
E Cortadora de gres
CN 瓷砖切割轮



COLOR BOX



| YATO  | L (mm) |  |
|--|--------|---|
| YT-3704 | 600 | 1 |
| YT-3705 | 900 | 1 |

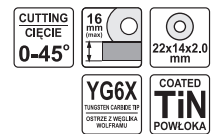

GB Tile cutting machine
D Fliesenschnidmaschine
PL Przystroj do cięcia glazury
RUS Плиткорез
CZ Přístroj na řezání glazury

H Csempevágó
RO Instrument de tăiere a glazurei
E Cortadora de gres
CN 瓷砖切割轮



COLOR BOX



| YATO  | L (mm) |  |
|--|--------|---|
| YT-3706 | 500 | 2 |
| YT-3707 | 600 | 2 |
| YT-3708 | 800 | 2 |

GB Tile cutting wheel
D Schneiderrad
PL Kółko tnące wymienne
RUS Ролик для плиткореза
CZ Výměnné kolečko
H Cseregőrgő csavarral
RO Cuițit rolă
E Recambio de cuchillo redondo
CN 瓷砖切割轮



SLIDING CARD



for / dla: YT-3704, YT-3705, YT-3706, YT-3707, YT-3708

| YATO  |  |
|--|---|
| YT-3714 | 50/200 |

GB Tile cutting pliers
D Glasurzange
PL Szczypce do cięcia i łamania glazury
RUS Кусачки для плитки

CZ Kleště do glazury
H Csempefogó
RO Cleste rupt faianta
E Tenazas para azulejos
CN 瓷砖钳

200 mm YG-6X



SLIDING CARD

| | | |
|-------------|--------|------|
| YATO | L (mm) | |
| YT-37160 | 200 | 6/36 |

GB Tile cutting pliers
D Glasurzange
PL Szczypce do glazury
RUS Кусачки для плитки
CZ Kleště do glazury

H Csempefogó
RO Cleste rupt faianta
E Tenazas para azulejos
CN 瓷砖钳

215 mm 17 mm

CUT CIECIE YG6X



SLIDING CARD

| | | |
|-------------|--------|------|
| YATO | L (mm) | |
| YT-37163 | 215 | 6/36 |

GB Tile cutting pliers
D Glasurzange
PL Szczypce do łamania glazury
RUS Кусачки для плитки
CZ Kleště do glazury

H Csempefogó
RO Cleste rupt faianta
E Tenazas para azulejos
CN 瓷砖钳

200 mm 2x YG-6X

COATED TiN POWLOKA



SLIDING CARD

| | | |
|-------------|--------|------|
| YATO | L (mm) | |
| YT-37161 | 200 | 6/36 |

GB Tile cutting pliers
D Glasurzange
PL Szczypce do glazury
RUS Кусачки для плитки
CZ Kleště do glazury

H Csempefogó
RO Cleste rupt faianta
E Tenazas para azulejos
CN 瓷砖钳

200 mm YG6X

CUT CIECIE



SLIDING CARD

| | | |
|-------------|--------|------|
| YATO | L (mm) | |
| YT-37164 | 200 | 6/60 |

GB Tile cutting pliers
D Glasurzange
PL Szczypce do glazury
RUS Кусачки для плитки
CZ Kleště do glazury

H Csempefogó
RO Cleste rupt faianta
E Tenazas para azulejos
CN 瓷砖钳

215 mm 17 mm

CUT CIECIE YG6X



SLIDING CARD

| | | |
|-------------|--------|------|
| YATO | L (mm) | |
| YT-37162 | 215 | 6/36 |

GB Grout remover
D Fugenreiniger
PL Skrobak do fug
RUS Скребок для швов кладки
CZ Škrabák na spáry

H Fugakihúzó
RO Răzuitoare pt. rosturi
E Rascador para juntas
CN 砂浆去除器



SLIDING CARD

| | | |
|-------------|--------|-------|
| YATO | L (mm) | |
| YT-37170 | | 10/60 |

GB Profile gauge
D Profilmuster
PL Wzornik profili

RUS Шаблон профилей
CZ Profilová šablona
H Profilsablon

RO Șablon profile
E Plantilla de perfiles
CN 轮廓仪



SLIDING
CARD





44
mm

1.5
mm



| YATO  | L (mm) |  |
|--|--------|---|
| YAT-3735 | 125 | 24/72 |

| YATO  | L (mm) |  |
|--|--------|---|
| YAT-3736 | 260 | 10/40 |



GB Scraper
D Spachtel
PL Szpachelka

RUS Шпатель
CZ Špachtle
H Spatula

RO Șpaclu
E Espátula
CN 油灰刀

Mn
65



| YATO  | W (mm) |  |
|--|--------|---|
| YT-5250 | 30 | 12/240 |
| YT-5251 | 40 | 12/240 |
| YT-5252 | 50 | 12/240 |
| YT-5253 | 60 | 12/240 |
| YT-5254 | 80 | 12/240 |
| YT-5255 | 100 | 12/240 |

GB Trowel for silicone
D Spachtel für Silikon
PL Szpachelka do silikonu

RUS Шпатель для силикона
CZ Špachtle na silikon
H Spachli szilikonhoz

RO Spatulă pt. silicon
E Espátula para silicona
CN 橡塑刮板

TPR



HANGING
CARD



| YATO  |  |
|--|---|
| YAT-5260 | 20/300 |



4
PCS

SLIDING
CARD



| YATO  |  |
|--|---|
| YAT-5261 | 20/200 |



4
PCS

SLIDING
CARD



| YATO  |  |
|--|---|
| YAT-5262 | 20/200 |

GB Smooth float
D Schweizer Glättkelle
PL Paca gładka
RUS Тёрка гладкая
CZ Hladitko rovné
H Glettväs rozsdamentes

RO Gletiera
E Llana para enlucido
CN 不锈钢砌墙刀



• made of special cold rolled stainless steel sheet with elasticity factor up to 2000 N/mm
• części robocze ze specjalnej zimnowalcowanej blachy nierdzewnej o sprężystości do 2000 N/mm

| YATO | mm | |
|---------|---------|----|
| YT-5202 | 270x130 | 30 |

GB Float with teeth
D Zahnkelle
PL Paca zębata
RUS Тёрка с зубами
CZ Hladitko zuby
H Glettväs fogazott

RO Gletiera zimtata
E Llana dentada
CN 不锈钢砌墙刀



• made of special cold rolled stainless steel sheet with elasticity factor up to 2000 N/mm
• części robocze ze specjalnej zimnowalcowanej blachy nierdzewnej o sprężystości do 2000 N/mm

| YATO | teeth / zęby | mm | |
|---------|--------------|---------|----|
| YT-5202 | 6x6 | 275x130 | 30 |
| YT-5203 | 8x8 | 270x130 | 30 |
| YT-5204 | 10x10 | 260x130 | 30 |

GB Smooth float
D Schweizer Glättkelle
PL Paca tynkarska
RUS Тёрка гладкая
CZ Hladitko rovné
H Glettväs rozsdamentes

RO Gletiera
E Llana para enlucido
CN 不锈钢砌墙刀



• made of special cold rolled stainless steel sheet with elasticity factor up to 2000 N/mm
• części robocze ze specjalnej zimnowalcowanej blachy nierdzewnej o sprężystości do 2000 N/mm

| YATO | mm | |
|---------|---------|----|
| YT-5207 | 380x130 | 40 |
| YT-5209 | 480x130 | 10 |
| YT-5210 | 580x130 | 10 |

GB Sharp ground float
D Steinholzglätter
PL Paca ostra
RUS Стальная острая тёрка
CZ Hladitko ocelové, špičaté
H Aljzatsimitó
RO Gletiera cu varf ascutit
E Llana pontiaguda
CN 不锈钢砌墙刀



| YATO | mm | |
|---------|-----|----|
| YT-5212 | 500 | 20 |

GB Smooth float
D Glättkelle
PL Paca wenecka
RUS Тёрка венецианская
CZ Hladitko rovné
H Glettväs rozsdamentes lágy fogantyúval

RO Gletiera
E Llana puntas redondas
CN 不锈钢砌墙刀



• made of special cold rolled stainless steel sheet with elasticity factor up to 2000 N/mm
• części robocze ze specjalnej zimnowalcowanej blachy nierdzewnej o sprężystości do 2000 N/mm

| YATO | mm | |
|---------|--------|----|
| YT-5214 | 200x80 | 20 |

GB Smooth float
D Glättkelle
PL Paca wenecka
RUS Тёрка венецианская
CZ Hladitko rovné
H Glettväs rozsdamentes lágy fogantyúval

RO Gletiera
E Llana puntas redondas
CN 不锈钢砌墙刀



• made of special cold rolled stainless steel sheet with elasticity factor up to 2000 N/mm
• części robocze ze specjalnej zimnowalcowanej blachy nierdzewnej o sprężystości do 2000 N/mm

| YATO | mm | |
|---------|-----------|----|
| YT-5216 | 75x95x240 | 20 |

GB Abrasive float "Rasp" type
D Styropor-Schleifbrett
PL Paca ścierna do styropianu
RUS Шлифовальная тёрка "рашпиль"
CZ Škrabák na porobeton
H Csiszoló polystirol habhoz
RO Gletiera abraziva

E Llana abrasiva para polietileno
CN 磨砂型砌墙刀



| YATO | mm | |
|---------|---------|----|
| YT-5218 | 165x370 | 20 |

GB Stripping knife
D Flächenspachtel
PL Szpachla fasadowa
RUS Стальной шпатель
CZ Stěrka fasádní
H Spatulya fali (rákli)
RO Spaclu inox
E Espátula de fachada
CN 剥皮刀



• made of special cold rolled stainless steel sheet with elasticity factor up to 2000 N/mm
• części robocze ze specjalnej zimnowalcowanej blachy nierdzewnej o sprężystości do 2000 N/mm



| YATO | mm | |
|---------|-----|----|
| YT-5226 | 250 | 20 |
| YT-5228 | 350 | 20 |
| YT-5230 | 500 | 20 |

- GB Articulated float with hydrorubber
D Deckenreibebrett Alu mit Schwammgummi
PL Paca przegubowa z hydrogumą
RUS Треугольный мастерок для каменщиков
CZ Hladítko ALU kloubové s hydrogumou
H Simító szivacsos durva nyelezhető
RO Gletiera cu burete cauciucat si maner multifunctional
E Llana para el acabado, articulada, de aluminio, con goma-espuma
CN 橡胶砌墙刀



AI

- large surface area and porous specialist hydro-rubber and practical articulated joint for setting on handle enables rapid floating without the necessity to use a ladder
- dzięki dużej powierzchni, porowatej specjalistycznej hydrogumie oraz praktycznemu przegubowi do osadzenia na trzonku pozwala na szybkie zacieranie bez potrzeby używania drabiny

| | | |
|---|---------|---|
| YATO  | mm |  |
| YT-5221 | 195x395 | 10 |

- GB Aluminium float with hydrorubber
D Alu-schwamm Brett mit hydrogummi
PL Paca aluminiowa z hydrogumą
RUS Терка алюминиевая с накладкой из губчатой резины
CZ Hladítko aluminiové s hydrogumou
H Fugázó alumíniumtestű hidroszivacsos
RO Gletiera de aluminiu cu hidrocauciuc
E Talocha aluminio con hidrogoma
CN 橡胶砌墙刀

AI

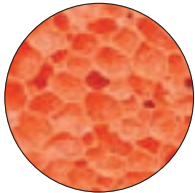



| | | |
|---|---------|---|
| YATO  | mm |  |
| YT-5302 | 130x270 | 12 |

- GB Aluminium float with sponge
D Alu-schwamm Brett mit schwamm
PL Paca aluminiowa z gąbką
RUS Терка алюминиевая с накладкой из поролона
CZ Hladítko aluminiové s hydrohoubou
H Fugázó alumíniumtestű szivacsos
RO Gletiera de aluminiu cu burete
E Talocha aluminio con esponja
CN 橡胶砌墙刀

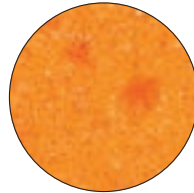
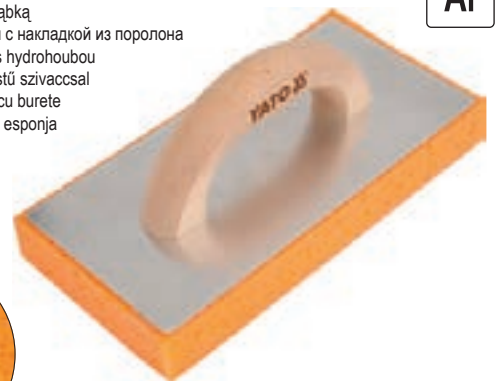
AI





| | | |
|---|---------|---|
| YATO  | mm |  |
| YT-5304 | 130x270 | 12 |

- GB Aluminium float with incised sponge
D Alu-schwamm Brett mit schwamm geschnitten
PL Paca aluminiowa z gąbką nacinaną
RUS Терка алюминиевая с накладкой из поролона надрезная
CZ Hladítko aluminiové s hydrohoubou dělenou
H Fugázó alumíniumtestű irdalt szivacsos
RO Gletiera de aluminiu burete cu striatii
E Talocha aluminio con esponja de incisiones
CN 橡胶砌墙刀

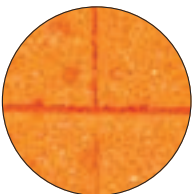
AI





| | | |
|---|---------|---|
| YATO  | mm |  |
| YT-5305 | 130x270 | 12 |

- GB Aluminium float with porous sponge
D Alu-schwamm Brett mit rauem schwamm
PL Paca aluminiowa z gąbką porowatą
RUS Терка алюминиевая с накладкой из микропористой резины
CZ Hladítko aluminiové s hrubou houbou
H Fugázó alumíniumtestű durva szivacsos
RO Gletiera de aluminiu cu burete poros
E Talocha aluminio con esponja de poros
CN 橡胶砌墙刀

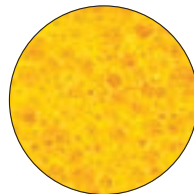
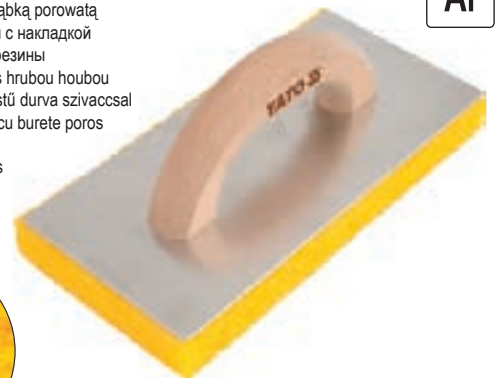
AI





| | | |
|---|---------|---|
| YATO  | mm |  |
| YT-5306 | 130x270 | 12 |

- GB Aluminium float with felt
D Alu-filzbrett
PL Paca aluminiowa z filcem
RUS Терка алюминиевая с накладкой из войлока
CZ Hladítko aluminiové s bílým filcem
H Fugázó alumíniumtestű filces
RO Gletiera de aluminiu cu pasla
E Talocha aluminio con fieltro
CN 橡胶砌墙刀

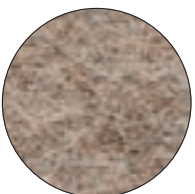
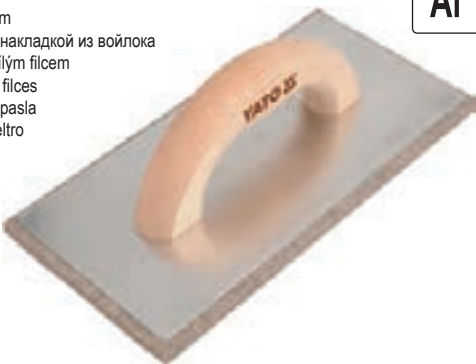
AI





| | | |
|---|---------|---|
| YATO  | mm |  |
| YT-5307 | 130x270 | 12 |

- GB Aluminium float with soft rubber
D Alu-gummibrett mit weichem gummi
PL Paca aluminiowa z miękką gumą
RUS Терка алюминиевая с накладкой из мягкой губчатой резины
CZ Hladítko aluminiové s měkkou gumou
H Fugázó alumíniumtestű lágy gumiszivacsos
RO Gletiera de aluminiu cu cauciuc moale
E Talocha aluminio con goma blanda
CN 橡胶砌墙刀

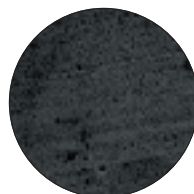
AI





| | | |
|---|--------|---|
| YATO  | mm |  |
| YT-5310 | 90x210 | 12 |

- GB Triangular trowel
D Maurerkelle
PL Kielnia trójkątna
RUS Треугольный мастерок
CZ Lžíce trojúhelníková
H Kőműves kanál háromszögletű
RO Mistrie triunghi
E Paleta triangular
CN 不锈钢砌墙刀



STAINLESS
STEEL
STAL
NERDZEWNA

- made of special cold rolled stainless steel sheet with elasticity factor up to 2000 N/mm
- części robocze ze specjalnej zimnowalcowanej blachy nierdzewnej o sprężystości do 2000 N/mm

| YATO  | mm |  |
|--|---------|---|
| YT-5234 | 200x190 | 10 |

- GB Trapezoid trowel
D Stukkateurkelle
PL Kielnia trapezowa
RUS Трапецидальный мастерок
CZ Lžíce zednická
H Kőműves kanál rozsdamentes
RO Mistrie
E Paleta trapezoidal
CN 不锈钢砌墙刀



STAINLESS
STEEL
STAL
NERDZEWNA

- made of special cold rolled stainless steel sheet with elasticity factor up to 2000 N/mm
- części robocze ze specjalnej zimnowalcowanej blachy nierdzewnej o sprężystości do 2000 N/mm

| YATO  | mm |  |
|--|------------|---|
| YT-5237 | 120x180x80 | 10 |

- GB Trapezoid trowel
D Stukkateurkelle
PL Kielnia trapezowa
RUS Трапецидальный мастерок
CZ Lžíce zednická
H Kőműves kanál rozsdamentes
RO Mistrie
E Paleta trapezoidal
CN 不锈钢砌墙刀



STAINLESS
STEEL
STAL
NERDZEWNA

- made of special cold rolled stainless steel sheet with elasticity factor up to 2000 N/mm
- części robocze ze specjalnej zimnowalcowanej blachy nierdzewnej o sprężystości do 2000 N/mm



| YATO  | mm |  |
|--|-----------|---|
| YT-5240 | 165x80x55 | 20 |

- GB Stucco trowel
D Gipserspachtel
PL Kielnia „Podkowa”
RUS Штукатурный мастерок
CZ Lžíce vymazávací
H Gittelő kanál rozsdamentes
RO Mistrie
E Paleta para estucado
CN 不锈钢砌墙刀



STAINLESS
STEEL
STAL
NERDZEWNA

- made of special cold rolled stainless steel sheet with elasticity factor up to 2000 N/mm
- części robocze ze specjalnej zimnowalcowanej blachy nierdzewnej o sprężystości do 2000 N/mm

| YATO  | mm |  |
|--|---------|---|
| YT-5242 | 100x130 | 20 |
| YT-5243 | 80x110 | 20 |

- GB Stucco sharp trowel
D Putzkelle
PL Kielnia ostra
RUS Кельма заостренная треугольная
CZ Lžíce pokrývačská
H Gittelő kanál rozsdamentes
RO Mistrie cu cioc ascutit
E Paleta pontiaguda
CN 不锈钢砌墙刀



STAINLESS
STEEL
STAL
NERDZEWNA



- made of special cold rolled stainless steel sheet with elasticity factor up to 2000 N/mm
- części robocze ze specjalnej zimnowalcowanej blachy nierdzewnej o sprężystości do 2000 N/mm

| YATO  | mm |  |
|--|--------|---|
| YT-5245 | 135x80 | 20 |

- GB Plaster scrubber
D Alu-Rabott
PL Zdzierak do tynków
RUS Треугольный мастерок для каменщиков
CZ Škrábák
H Vakolat gyalu alu késes
RO Gletiera abraziva
E Rascador para enlucido
CN 石膏去除器



AI

| YATO  | mm |  |
|--|--------|---|
| YT-5247 | 450x90 | 25 |

GB Tin snips
D Blechscherer
PL Nożyce do cięcia blachy

RUS Ножницы по металлу
CZ Nůžky na plech
H Lemezvágó olló

RO Foarfece pt. tablă
E Tijeras para chapas
CN 航空剪

SLIDING
CARD



**DROP
FORGED
KUTE**

**HRC
58-61**



**LEFT
CUT
CIĘCIE
LEWE**

| YATO | L (mm) | cutting length (mm) | cutting capacities (mm) | | | | 6/24 |
|---------|--------|---------------------|-------------------------|-------------------|------------------|---------------------|------|
| | | | copper | cold-rolled steel | hard steel HRC35 | stainless steel 304 | |
| YT-1900 | 260 | 30 | 0.94 | 0.78 | 0.60 | 0.45 | |



**RIGHT
CUT
CIĘCIE
PRAWĘ**

| YATO | L (mm) | cutting length (mm) | cutting capacities (mm) | | | | 6/24 |
|---------|--------|---------------------|-------------------------|-------------------|------------------|---------------------|------|
| | | | copper | cold-rolled steel | hard steel HRC35 | stainless steel 304 | |
| YT-1901 | 260 | 30 | 0.94 | 0.78 | 0.60 | 0.45 | |



**LEFT
CUT
CIĘCIE
LEWE**

| YATO | L (mm) | cutting length (mm) | cutting capacities (mm) | | | | 6/24 |
|---------|--------|---------------------|-------------------------|-------------------|------------------|---------------------|------|
| | | | copper | cold-rolled steel | hard steel HRC35 | stainless steel 304 | |
| YT-1902 | 300 | 50 | 0.94 | 0.78 | 0.60 | 0.45 | |



**STRAIGHT
CUT
CIĘCIE
PROSTE**

| YATO | L (mm) | cutting length (mm) | cutting capacities (mm) | | | | 6/36 |
|---------|--------|---------------------|-------------------------|-------------------|------------------|---------------------|------|
| | | | copper | cold-rolled steel | hard steel HRC35 | stainless steel 304 | |
| YT-1925 | 225 | 52 | 0.94 | 0.78 | 0.60 | 0.45 | |

GB Tin snips
D Blechscherer
PL Nożyce do cięcia blachy
RUS Ножницы по металлу
CZ Nůžky na plech
H Lemezvágó olló
RO Foarfece pt. tablă
E Tijeras para chapas
CN 铁皮剪



SLIDING
CARD



**HRC
60-62**

CrMo

90°

**SERRATED
EDGES
ZĄBOWANA
KRAWĘDZ
OSTRY**



**LEFT
CUT
CIĘCIE
LEWE**



**RIGHT
CUT
CIĘCIE
PRAWĘ**

| YATO | L (mm) | cutting length (mm) | cutting capacities (mm) | | | | 6/36 |
|---------|--------|---------------------|-------------------------|-------------------|------------------|---------------------|------|
| | | | copper | cold-rolled steel | hard steel HRC35 | stainless steel 304 | |
| YT-1913 | 225 | 30 | 0.78 | 0.53 | 0.46 | 0.36 | |

| YATO | L (mm) | cutting length (mm) | cutting capacities (mm) | | | | 6/36 |
|---------|--------|---------------------|-------------------------|-------------------|------------------|---------------------|------|
| | | | copper | cold-rolled steel | hard steel HRC35 | stainless steel 304 | |
| YT-1914 | 225 | 30 | 0.78 | 0.53 | 0.46 | 0.36 | |

- GB Portable nothers
- D Schere zum Ausschneiden von Ecken
- PL Nożyce do wycinania naroży
- RUS Ножницы для наружных углов
- CZ Nůžky na vystřihování rohů
- H Sarokkivágó olló
- RO Foarfeca pt. taierea colturilor
- E Tijera para esquinas
- CN 截角器

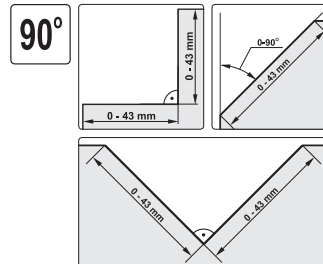

COLOR BOX



| YATO | L (mm) | |
|---------|--------|----|
| YT-1939 | 300 | 15 |

- GB Straight pliers
- D Zange zum Blechbiegen
- PL Kleszcze do gięcia blach
- RUS Клещи с тупым ножом для жести
- CZ Kleště na ohýbání plechu
- H Falcfogó
- RO Cleste pt. indoirea tablei
- E Tenazas para doblar hojalata
- CN 钣金钳

COLOR BOX



| YATO | L (mm) | |
|---------|--------|-------|
| YT-5416 | 280 | 10/20 |

| YATO | L (mm) | |
|---------|--------|-------|
| YT-5417 | 260 | 10/20 |

| YATO | L (mm) | |
|---------|--------|-------|
| YT-5415 | 280 | 10/20 |

- GB Single seam clench
- D Klemme für Einfachfalz
- PL Zaciskacz rąbka pojedynczego
- RUS Зажим отдельного фальца
- CZ Uzavírač jednoduché drážky
- H Falclezáró fogó
- RO Clema pt. falt simplu
- E Pinza para costura individual
- CN 屋顶施工工具

- GB Double seam clench
- D Klemme für Doppelfalz
- PL Zaciskacz rąbka podwójnego
- RUS Зажим двойного фальца
- CZ Uzavírač dvojité drážky
- H Duplafalclezáró fogó
- RO Clema pt. falt dublu
- E Pinza para costura doble
- CN 屋顶施工工具

- GB Eaves turner
- D Kantvorrichtung für Dachtraufe
- PL Kantownik okapu
- RUS Угольник навеса
- CZ Ohýbačka okapnice
- H Ereszperemező fogó
- RO Cornier streasina
- E Volteador de alero
- CN 屋顶施工工具

- GB Eaves clench
- D Klemme für Dachtraufe
- PL Zaciskacz okapu
- RUS Зажим навеса
- CZ Uzavírač okapnice
- H Ereszszáró fogó
- RO Clema pt. streasina
- E Pinza para alero
- CN 屋顶施工工具



| YATO | Ø (mm) pipe / rurki | mm | |
|---------|------------------------|---------|---|
| YT-5400 | 18 | 480x220 | 5 |



| YATO | Ø (mm) pipe / rurki | mm | |
|---------|------------------------|---------|---|
| YT-5402 | 18 | 480x220 | 5 |





| YATO | Ø (mm) pipe / rurki | mm | |
|---------|------------------------|---------|---|
| YT-5404 | 18 | 450x200 | 5 |



| YATO | Ø (mm) pipe / rurki | mm | |
|---------|------------------------|---------|---|
| YT-5405 | 18 | 450x200 | 5 |



- GB Drainpipe hooks bender
D Biegewerkzeuge für Dachrinnenhaken
PL Zaginacz haków rynnowych
RUS Прибор для загибання крюков для водосточных желобов
CZ Ohýbačka okapových háků
H Ereszcstatorna-tartóvas hajlító
RO Dispozitiv pt. îndoiți cârlige burlan
E Herramienta para doblar los ganchos para canalones
CN 弯管器



| YATO  | L (mm) |  |
|--|--------|---|
| YT-5410 | 680 | 5 |

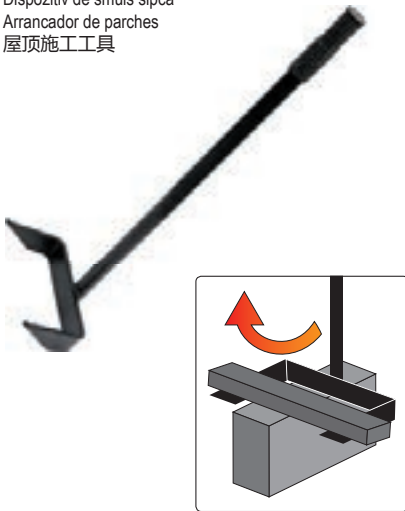

- GB Patch puller
D Vorrichtung zum Ausreißen von Latten
PL Wyrzycacz lat
RUS Выдёргиватель планок
CZ Třhač latění
H Foltbontó vas
RO Dispozitiv de smuls sipca
E Arrancador de parches
CN 屋顶施工工具



| YATO  | ∅ pipe / rurki (mm) | mm |  |
|--|---------------------|---------|---|
| YT-5406 | 25 | 700x140 | 6 |



- GB Roofing paper unreeling rod
D Stange zum Abwickeln der Dachpappe
PL Laska do rozwijania papy
RUS Штeхер для развёртывания толевого картона
CZ Tyč k odvíjení asfaltových pásů
H Pálca kátránypapír kiterítéséhez
RO Bara de întins membrana bituminoasa
E Vara para desenrollar cartón asfaltado/cartón alquitrinado
CN 油毡解卷器



| YATO  | ∅ pipe / rurki (mm) | mm |  |
|--|---------------------|----------|---|
| YT-5407 | 18 | 1100x230 | 10 |

- GB Roofing paper unreeler
D Dachpappenabwickler
PL Rozwijacz papy
RUS Расправитель толевого картона
CZ Vodicí tyč k pokládce asfaltových pásů
H Kátránypapír kiterítő
RO Derulator pt. membrana bituminoasa
E Desenrollador para cartón asfaltado/cartón alquitrinado
CN 油毡解卷器





| YATO  | ∅ pipe / rurki (mm) | mm |  |
|--|---------------------|------|---|
| YT-5408 | 22 | 1350 | 5 |

- GB Rectangular floating rule
D Setzlatte 2 Libellen
PL Łata murarska
RUS Правило-уровень
CZ Lat' zednická s libelami
H Ölesléc, téglalap keresztmetszetű
RO Dreptar cu 2 bule
E Nivel de albañil
CN 刮板





ACCURACY
0.057°
= 1 mm/m
2
PRECISION
VIALS





| YATO  | L (mm) |  |
|--|--------|---|
| YT-3071 | 1500 | 10 |
| YT-3072 | 2000 | 10 |
| YT-3073 | 2500 | 10 |
| YT-3074 | 3000 | 10 |



| YATO  | L (mm) |  |
|--|--------|---|
| YT-3076 | 1500 | 10 |
| YT-3077 | 2000 | 10 |
| YT-3078 | 2500 | 10 |
| YT-3079 | 3000 | 10 |

- GB Trapezoid floating rule
D Abziehlatte mit Trapezprofil
PL Łata tynkarska
RUS Правило трапециевидное
CZ Lat' maliřská
H Ölesléc, trapézoid keresztmetszetű
RO Dreptar trapezoidal
E Nivel de albañil
CN 梯形刮板



| YATO  | L (mm) |  |
|--|--------|---|
| YT-3081 | 1500 | 10 |
| YT-3082 | 2000 | 10 |
| YT-3083 | 2500 | 10 |
| YT-3084 | 3000 | 10 |

- GB Knife for roofing paper
- D Messer zum Schneiden von Pappe
- PL Nóż do cięcia papy
- RUS Нож для резки рубероида
- CZ Nůž k řezání lepenky
- H Kátrányapapírvágó olló
- RO Cutter pt. tăierea cartonului asfaltat
- E Cuchilla para cortar cartón alquitranado
- CN 多功能刀



SLIDING CARD

| YATO | L (mm) | Box |
|---------|--------|-------|
| YT-7620 | 230 | 12/60 |

- GB Knife for mineral wool
- H Kés épületszigetelés vágásához
- D Messer zum Schneiden von Bausisolierungen
- RO Cutter pt. tăierea izolațiilor
- PL Nóż do cięcia izolacji budowlanych
- E Cuchilla para cortar aislamiento de construcción
- RUS Нож для резки строительной изоляции
- CN 多功能刀
- CZ Nůž k řezání stavebních izolačních hmot

SLIDING CARD



| YATO | L (mm) | Box |
|---------|--------|-------|
| YT-7623 | 500 | 10/50 |



| YATO | L (mm) | Box |
|---------|--------|-------|
| YT-7624 | 480 | 10/50 |

- GB Electric hoist
- D Elektro-Seilwinde
- PL Elektryczna wciągarka linowa
- RUS Электрическая канатная лебедка
- CZ Elektrický naviják kladkostroj
- H Elektromos csőrlő
- RO Troliu electric cu cablu
- E Cabria eléctrica de cuerdas
- CN 电动葫芦

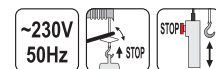

COLOR BOX



| | | | | | | |
|------|---|---------|--------|--------|-------------------|-------------------|
| YATO | 2 | 500 W | 125 kg | 250 kg | 10 m/min max. 11m | 5 m/min max. 5.5m |
| | | YT-5901 | 125 kg | 250 kg | 150 kg | 300 kg |
| YATO | 2 | 550 W | 150 kg | 300 kg | 10 m/min max. 11m | 5 m/min max. 5.5m |
| | | YT-5902 | 150 kg | 300 kg | 250 kg | 500 kg |
| YATO | 2 | 900 W | 250 kg | 500 kg | 10 m/min max. 11m | 5 m/min max. 5.5m |
| | | YT-5904 | 250 kg | 500 kg | 300 kg | 600 kg |
| YATO | 2 | 1050 W | 300 kg | 600 kg | 10 m/min max. 11m | 5 m/min max. 5.5m |
| | | YT-5905 | 300 kg | 600 kg | | |

GB Extension cord
D Verlängerungskabel
PL Przedłużacz elektryczny
RUS Удлинитель электрический
CZ Elektrický prodloužovač
H Elektromos hosszabbító
RO Prelungitor electric
E Extensión electr.
CN 电缆延长线

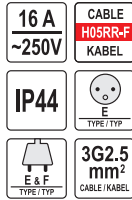

| YATO | L (m) | |
|---------|-------|---|
| YT-8100 | 20 | 4 |
| YT-8101 | 30 | 2 |
| YT-8102 | 40 | 2 |

GB Rubber protection extension cord
D Gummiisolierte Verlängerungsschnur
PL Przedłużacz w osłonie gumowej
RUS Удлинитель с резиновой изоляцией
CZ Prodloužovací kabel s gumovou izolací
H Gumi szigetelésű hosszabbító
RO Cablu prelungitor cauciuc
E Cable de extensi3n con protecci3n de caucho
CN 电缆延长线

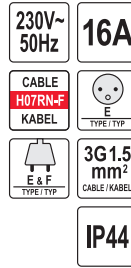

| YATO | L (m) | |
|---------|-------|----|
| YT-8110 | 2 | 40 |
| YT-8111 | 5 | 16 |
| YT-8112 | 10 | 8 |

GB Rubber protection extension cord
D Gummiisolierte Verlängerungsschnur
PL Przedłużacz w osłonie gumowej
RUS Удлинитель с резиновой изоляцией
CZ Prodloužovací kabel s gumovou izolací
H Gumi szigetelésű hosszabbító
RO Cablu prelungitor cauciuc
E Cable de extensi3n con protecci3n de caucho
CN 电缆延长线

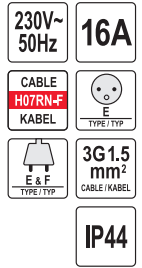

| YATO | L (m) | |
|---------|-------|----|
| YT-8115 | 2 | 10 |
| YT-8116 | 10 | 4 |

GB Cable reel
D Kabeltrommel
PL Przedłużacz zwijany
RUS Удлинитель электрический
CZ Bubnový prodloužovač
H Kábeldob
RO Prelungitor pe tambur
E Cable de prolongaci3n de tambor
CN 电缆延长线

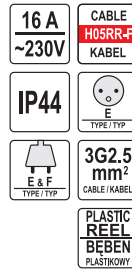

• $P_{max} = 1200$ W coiled
 $P_{max} = 1200$ W zwinięty
• $P_{max} = 3600$ W uncoiled
 $P_{max} = 3600$ W rozwinęty

| YATO | L (m) | |
|---------|-------|---|
| YT-8106 | 30 | 1 |
| YT-8107 | 40 | 1 |
| YT-8108 | 50 | 1 |

GB Drum power extension cord
D Verlängerungstrommel für Kraftstrom
PL Przedłużacz bębnowy siłowy
RUS Силовый удлинитель барабанного типа
CZ Prodloužovací kabel silový na bubnu
H Háromfázisú hosszabbító dob
RO Derulator cu tambur
E Cilindro de extensi3n de fuerza
CN 电缆延长线

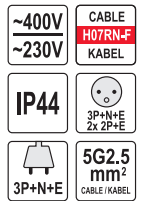

• ~230V; 2P+E
 $P_{max} = 1200$ W coiled
 $P_{max} = 1200$ W zwinięty
 $P_{max} = 3000$ W uncoiled
 $P_{max} = 3000$ W rozwinęty

• ~400V; 3P+N+E
 $P_{max} = 3000$ W coiled
 $P_{max} = 3000$ W zwinięty
 $P_{max} = 9000$ W uncoiled
 $P_{max} = 9000$ W rozwinęty

| YATO | L (m) | |
|---------|-------|---|
| YT-8120 | 25 | 1 |

GB Cup mixer
D Korbbrüher für klumpige, zähe Materialien
PL Mieszadło koszykowe

RUS Краскомешалка
CZ Košíkové míchadlo
H Kosaras keverő

RO Mixer pt. vopsea - tip pahar
E Agitador de cesta
CN 搅拌器



- application: powder materials, sealing compounds, gypsum surface finishing mixes, self-leveling mortars
- zastosowanie: materiały sypkie, masy uszczelniające, gładzie szpachlowe, zaprawy samopoziomujące

| YATO | Ø (mm) | L (mm) | shank / uchwyt | max. mixing capacity / max. wydajność mieszania (kg) | ☐ |
|---------|--------|--------|-------------------|---|----|
| YT-5481 | 80 | 470 | HEX | 5-10 | 25 |
| YT-5482 | 100 | 470 | HEX | 10-20 | 20 |
| YT-5483 | 100 | 600 | SDS+ | 10-20 | 18 |

GB Spiral bar mixer
D Rundstabbrüher für klebrige, geschmeidige Materialien
PL Mieszadło spiralne prętowe

RUS Краскомешалка
CZ Spirálové míchadlo drátové
H Spirális, pálcás keverő

RO Malaxor pt. vopsea
E Agitadore pala/cinta
CN 搅拌器



- application: powder materials, general-purpose adhesives, gypsum surface finishing mixes, epoxy grouts
- zastosowanie: materiały sypkie, gotowe zaprawy klejowe, masy szpachlowe, zaprawy do spoinowania

| YATO | Ø (mm) | L (mm) | shank / uchwyt | max. mixing capacity / max. wydajność mieszania (kg) | ☐ |
|---------|--------|--------|-------------------|---|----|
| YT-5490 | 85 | 410 | HEX | 4-9 | 30 |
| YT-5491 | 100 | 600 | HEX | 6-16 | 16 |
| YT-5492 | 85 | 450 | SDS+ | 4-9 | 30 |
| YT-5493 | 100 | 600 | SDS+ | 6-16 | 16 |

GB Spiral mixer
D Rondenbrüher für dünnflüssige Materialien
PL Mieszadło spiralne

RUS Краскомешалка
CZ Spirálové míchadlo
H Spirális keverő

RO Malaxor pt. vopsea
E Agitador de cinta helicoidal
CN 搅拌器



- application: emulsion paints, acrylic paints, lacquers, stains, other liquid materials
- zastosowanie: farby emulsyjne, farby akrylowe, lakiery, bejce, inne materiały płynne

| YATO | Ø (mm) | L (mm) | shank / uchwyt | max. mixing capacity / max. wydajność mieszania (kg) | ☐ |
|---------|--------|--------|-------------------|---|----|
| YT-5494 | 80 | 400 | HEX | 5-10 | 30 |
| YT-5495 | 100 | 600 | HEX | 10-25 | 20 |
| YT-5496 | 100 | 600 | SDS+ | 15-30 | 20 |

GB Double spiral mixer
D Wendelbrüher für klebrige, zähe Materialien
PL Mieszadło spiralne podwójne

RUS Краскомешалка
CZ Spirálové míchadlo dvojité
H Dupla spirális keverő

RO Malaxor spirala dubla pt. vopsea
E Agitador de cinta helicoidal doble
CN 搅拌器



- application: general-purpose adhesives, masonry mortars, jointless floors, thin-layer mineral plasters, gypsum surface finishing mixes, isolation masses
- zastosowanie: zaprawy klejowe, zaprawy murarskie, jastrych, tynki strukturalne, masy szpachlowe, masy izolacyjne

| YATO | Ø (mm) | L (mm) | shank / uchwyt | max. mixing capacity / max. wydajność mieszania (kg) | ☐ |
|---------|--------|--------|-------------------|---|----|
| YT-5497 | 70 | 400 | HEX | 5-10 | 20 |
| YT-5499 | 100 | 600 | HEX | 10-20 | 16 |
| YT-5500 | 120 | 600 | HEX | 15-25 | 14 |
| YT-5501 | 100 | 600 | SDS+ | 10-20 | 16 |
| YT-5502 | 120 | 600 | SDS+ | 15-25 | 14 |
| YT-5503 | 120 | 600 | M14 | 15-25 | 14 |
| YT-5504 | 160 | 600 | M14 | 20-30 | 8 |

GB Triple spiral mixer
D Wendelbrüher für schwere, zähe Materialien
PL Mieszadło spiralne potrójne

RUS Краскомешалка
CZ Spirálové míchadlo trojité
H Tripla spirális keverő

RO Malaxor spirala tripla pt. vopsea
E Agitador de cinta helicoidal triple
CN 搅拌器



- application: mortars, concrete, plasters, other semi-fluid materials with sand or gravel filling
- zastosowanie: zaprawy, beton, tynki, inne półpłynne, lepkie materiały z wypełnieniem piaskowym lub żwirowym

| YATO | Ø (mm) | L (mm) | shank / uchwyt | max. mixing capacity / max. wydajność mieszania (kg) | ☐ |
|---------|--------|--------|-------------------|---|----|
| YT-5505 | 100 | 600 | HEX | 10-20 | 16 |
| YT-5506 | 120 | 600 | SDS+ | 15-25 | 12 |
| YT-5507 | 120 | 600 | M14 | 15-25 | 12 |
| YT-5508 | 160 | 600 | M14 | 20-30 | 8 |

GB Carpenter's pencil
D Zimmermannsbleistift
PL Ołówek stolarski

RUS Карандаш столярный
CZ Tesařská tužka
H Asztalos ceruza

RO Creion de tâmplărie
E Lapiz de carpintero
CN 木工铅笔

COLOR BOX



144 PCS HB

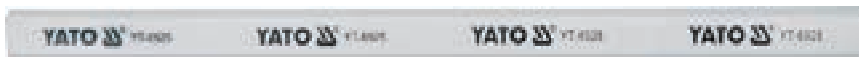

| YATO | L (mm) | W (mm) | PCS packing: | ☐ |
|---------|--------|--------|-----------------|---|
| YT-6925 | 245 | 15 | 144 | 8 |



| YATO | L (mm) | W (mm) | PCS packing: | ☐ |
|---------|--------|--------|-----------------|---|
| YT-6926 | 245 | 12 | 144 | 8 |

GB Masonry pencil
D Maurerbleistift
PL Ołówek murarski

RUS Карандаш каменщика
CZ Tužka zednická
H Kőműves keverő

RO Creion
E Lapiz de albañil
CN 木工铅笔

COLOR BOX



144 PCS HB



| YATO | L (mm) | W (mm) | PCS packing: | ☐ |
|---------|--------|--------|-----------------|---|
| YT-6927 | 245 | 12 | 144 | 8 |

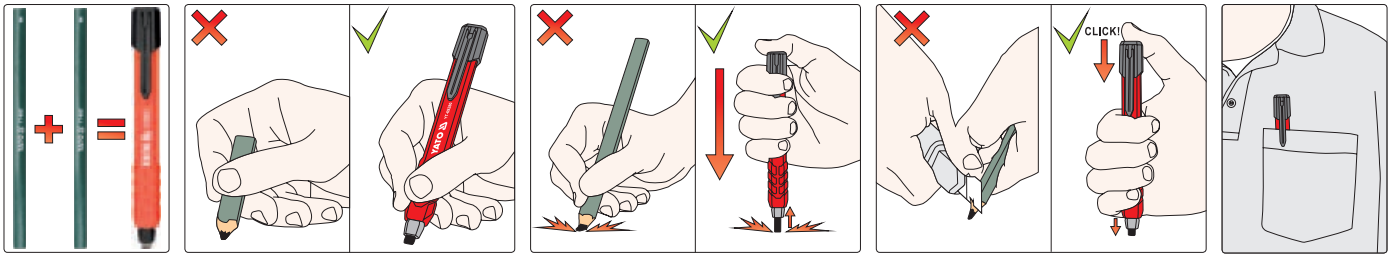

- GB Automatic carpenters/masonry pencil
D Tischler- und Maurer-Druckstift
PL Ołówek stolarski/murarski automatyczny
RUS Автоматический столярный карандаш/карандаш каменщика
- CZ Stolařská/zednická tužka automatická
H Asztalos/kőműves töltőceruza
RO Creion de tâmplărie/zidărie mecanic
E Lápiz automático de carpintero/albanil
CN 自动木工铅笔

HB



| | |
|-------------|---------|
| YATO | |
| YT-69280 | 50/1000 |

- GB Automatic carpenters/masonry pencil with spare leads
D Tischler- und Maurer-Druckstift + zusätzliche Bleistiftmine
PL Ołówek stolarski/murarski automatyczny + dodatkowe grafity
RUS Автоматический столярный карандаш/карандаш каменщика + дополнительный графит
- CZ Stolařská/zednická tužka automatická + náhradní tuha
H Asztalos/kőműves töltőceruza + tartalék grafit
RO Creion de tâmplărie/zidărie mecanic + grafit adițional
E Lápiz automático de carpintero/albanil + mina adicional
CN 自动木工铅笔套装

1+5
LEADS
WKŁADY

HB

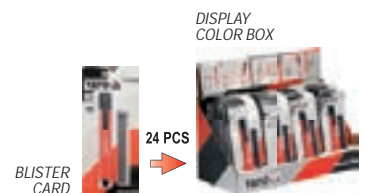

| | |
|-------------|-----|
| YATO | |
| YT-69281 | 144 |

13

- GB Lead HB
D Bleistiftmine HB
PL Grafit HB
RUS Графит HB
CZ Tuha HB
H Grafit HB
RO Grafit HB
E Mina HB
CN 自动木工铅笔笔芯



5
LEADS
WKŁADÓW

HB

PLASTIC TUBE

for / dla: YT-69280, YT-69281

| | |
|-------------|---------|
| YATO | |
| YT-69285 | 20/1000 |

- GB Lead H2
D Bleistiftmine H2
PL Grafit H2
RUS Графит H2
CZ Tuha H2
H Grafit H2
RO Grafit H2
E Mina H2
CN 自动木工铅笔笔芯



5
LEADS
WKŁADÓW

H2

PLASTIC TUBE

for / dla: YT-69280, YT-69281

| | |
|-------------|---------|
| YATO | |
| YT-69286 | 20/1000 |

- GB Lead HB
D Bleistiftmine HB
PL Grafit HB
RUS Графит HB
CZ Tuha HB
H Grafit HB
RO Grafit HB
E Mina HB
CN 自动木工铅笔笔芯



5
LEADS
WKŁADÓW

HB

WHITE
BIAŁY

PLASTIC TUBE

for / dla: YT-69280, YT-69281

| | |
|-------------|---------|
| YATO | |
| YT-69287 | 20/1000 |

14

Measuring tools Narzędzia miernicze



Electric meters
Mierniki elektryczne

242



Try squares
Kątowniki stolarskie

246



Multimeters
Mierniki

243



Vernier calipers
Suwmiarki

246



Measuring tapes
Miary zwijane

244-245



Electronic measuring tools
Elektroniczne urządzenia pomiarowe

247



Folding rules
Miary składane

246



Levels
Poziomnice

248



Rulers
Przymiary

246



Feelers
Szczelinomierze

248



GB Digital voltage tester
 D Digitaler-Spannungsprüfer
 PL Wskaźnik elektryczny
 RUS Тестер напряжения цифровой
 CZ Zkoušečka napětí digitální

H Digitális voltmérő
 RO Tester digital pt. tensiune electrica
 E Indicador eléctrico
 CN 数显测电笔

SLIDING CARD



12-250 V
 50-500 Hz
 LCD DISPLAY
 NO BATTERY NEEDED
 NE POTREBUJE BATERII



YATO
 YT-2861 20/500



YATO
 YT-2862 20/500



YATO
 YT-2863 6/120

GB Analogue battery tester
 D Analoges Batterieprüfgerät
 PL Tester akumulatorów analogowy
 RUS Аналоговый тестер аккумуляторов
 CZ Analogový tester akumulátorů
 H Analóg akkuteszter
 RO Tester acumulatori analog
 E Tester analógico para acumuladores
 CN 电池测试器

6 V
 12 V
 CCA 200-1000 A

GB Digital battery tester
 D Digitales Batterieprüfgerät
 PL Tester akumulatorów cyfrowy
 RUS Цифровой тестер аккумуляторов
 CZ Digitální tester akumulátorů
 H Digitális akkuteszter
 RO Tester acumulatori digital
 E Tester digital para acumuladores
 CN 电池测试器

12 V
 LED DISPLAY
 CCA 150-1400 A

GB Battery tester
 D Batterieprüfgerät
 PL Tester akumulatorów
 RUS Тестер аккумуляторов
 CZ Tester akumulátorů
 H Akkuteszter
 RO Tester acumulatori
 E Tester para acumuladores
 CN 电池测试器

12 V
 BATTERY TEST
 TEST AKUMULATORA
 ALTERNATOR TEST
 TEST ALTERNATORA



COLOR BOX



YATO
 YT-8310 10



COLOR BOX



YATO
 YT-8311 10



DOUBLE BLISTER



YATO
 YT-83101 12/72

GB Digital universal multimeter
D Universell digital Messgerät
PL Cyfrowy miernik uniwersalny
RUS Универсальный цифровой измеритель
CZ Digitální multimetr univerzální
H Digitális multiméter
RO Multimetru digital universal
E Manómetro digital universal
CN 数字万用表

| | | |
|------------------|------------------|-------------------------------|
| U 0-500 ~V | U 0-500 ~V | I 0-5 ~A |
| R 0-2 MΩ | | h _{FE} PNP NPN |
| | | |



COLOR BOX

| | | | | | |
|-------------------|-------------------------------|----------------------|-----------------|-----------------|-----------------|
| U 0-1000 ~V | U 0-750 ~V | I 0-10 ~A | I 0-10 ~A | R 0-20 MΩ | C 0-20 μF |
| | h _{FE} PNP NPN | AUTO POWER OFF | | | |



COLOR BOX

| | | | | | |
|----------------------|------------------|-------------------------------|---------------------------------|----------------------|-------------------|
| U 0-600 ~V | U 0-600 ~V | I 0-10 ~A | I 0-10 ~A | R 0-20 MΩ | C 0-1000 μF |
| T -20° +1000°C | | h _{FE} PNP NPN | AUTO RANGE AUTO ZAKRES | AUTO POWER OFF | |



COLOR BOX

YATO 50

YATO 30

YATO 44

| | | | | | |
|------------------|------------------|------------------|----------------------|----------------------|---------------------------------|
| | U 0-600 ~V | U 0-600 ~V | I 0-10 ~A | I 0-10 ~A | R 0-40 MΩ |
| C 0-100 μF | f 100 kHz | | T -20° +1000°C | | AUTO RANGE AUTO ZAKRES |
| | | | | AUTO POWER OFF | |



NYLON CASE & COLOR BOX

| | | | | | |
|------------------|------------------|---------------------------------|----------------------|-----------------|--------------------|
| 5 in 1 5 w 1 | U 0-600 ~V | U 0-600 ~V | I 0-10 ~A | I 0-10 ~A | R 0-40 MΩ |
| C 0-100 μF | f 200 kHz | | T -20° +1000°C | | %RH 30%± 90% |
| | | AUTO RANGE AUTO ZAKRES | AUTO POWER OFF | | |



NYLON CASE & COLOR BOX

| | | | | | |
|-------------------|-------------------|------------------|----------------------|----------------------|---------------------------------|
| TRUE RMS | U 0-600 ~V | U 0-600 ~V | I 0-10 ~A | I 0-10 ~A | R 0-60 MΩ |
| C 0-4000 μF | f 9.999 MHz | | T -20° +1000°C | | AUTO RANGE AUTO ZAKRES |
| | | | | AUTO POWER OFF | |



COLOR BOX

YATO 24

YATO 24

YATO 20



| | | | |
|----------------------|------------------|---------------------------------|----------------------|
| U 0-600 ~V | U 0-600 ~V | I 0-600 ~A | R 0-200 MΩ |
| T -20° +1000°C | | AUTO RANGE AUTO ZAKRES | AUTO POWER OFF |
| | | | |

NYLON CASE & COLOR BOX



YATO 20

GB Measuring tape RUS Рулетка H Mérőszalag E Flexómetro
 D Rollbandmass CZ Měřicí pásno RO Rulete din pinza CN 卷尺
 PL Miara zwijana

3m 16mm
 5m 19mm
 AUTOMATIC STOP
 GRADE II
 MAGNETIC HOOK
 NYLON COATED



SLIDING CARD
 3m 16mm
 5m 25mm
 8m 25mm
 AUTOMATIC STOP
 GRADE II
 MAGNETIC HOOK
 NYLON COATED



DOUBLE BLISTER

| YATO | L (m) | size / rozmiar (mm) | |
|---------|-------|---------------------|--------|
| YT-7103 | 3 | 16 | 12/120 |
| YT-7105 | 5 | 19 | 12/120 |

| YATO | L (m) | size / rozmiar (mm) | |
|---------|-------|---------------------|--------|
| YT-7110 | 3 | 16 | 12/120 |
| YT-7111 | 5 | 25 | 12/120 |
| YT-7112 | 8 | 25 | 6/60 |

3m 16mm
 5m 19mm
 8m 25mm
 GRADE II
 MAGNETIC HOOK
 NYLON COATED



DOUBLE BLISTER
 3m 16mm
 5m 19mm
 8m 25mm
 GRADE II
 MAGNETIC HOOK
 NYLON COATED



DOUBLE BLISTER

| YATO | L (m) | size / rozmiar (mm) | |
|---------|-------|---------------------|--------|
| YT-7116 | 3 | 16 | 12/120 |
| YT-7117 | 5 | 19 | 12/120 |
| YT-7118 | 8 | 25 | 6/60 |

| YATO | L (m) | size / rozmiar (mm) | |
|---------|-------|---------------------|--------|
| YT-7126 | 3 | 16 | 12/120 |
| YT-7127 | 5 | 19 | 12/120 |
| YT-7128 | 8 | 25 | 6/60 |

3m 16mm
 5m 19mm
 8m 25mm
 GRADE II
 MAGNETIC HOOK
 NYLON COATED



DOUBLE BLISTER
 3m 16mm
 5m 19mm
 8m 25mm
 GRADE II



DISPLAY BOX

| YATO | L (m) | size / rozmiar (mm) | |
|---------|-------|---------------------|--------|
| YT-7129 | 3 | 16 | 12/120 |
| YT-7130 | 5 | 19 | 12/120 |
| YT-7131 | 8 | 25 | 6/60 |

| YATO | L (m) | size / rozmiar (mm) | PCS packing | |
|----------|-------|---------------------|-------------|--------|
| YT-71130 | 3 | 16 | 12 | 60/120 |
| YT-71131 | 5 | 19 | 12 | 48/96 |
| YT-71133 | 8 | 25 | 12 | 18/36 |

3m 16mm
 5m 19mm
 8m 25mm
 GRADE II



DOUBLE BLISTER
 3m 16mm
 5m 19mm
 7.5m 25mm
 10m 25mm
 10ft 5/8"
 16ft 3/4"
 25ft 1"
 33ft 1"
 GRADE II



DOUBLE BLISTER

| YATO | L (m) | size / rozmiar (mm) | |
|----------|-------|---------------------|--------|
| YT-71135 | 3 | 16 | 12/144 |
| YT-71136 | 5 | 19 | 12/72 |
| YT-71138 | 8 | 25 | 8/48 |

| YATO | L | size / rozmiar | |
|----------|---------------|----------------|--------|
| YT-71141 | 3 m / 10 ft | 16 mm / 5/8" | 12/144 |
| YT-71143 | 5 m / 16 ft | 19 mm / 3/4" | 12/96 |
| YT-71145 | 7.5 m / 25 ft | 25 mm / 1" | 12/48 |
| YT-71146 | 10 m / 33 ft | 25 mm / 1" | 12/36 |

GB Measuring tape H Mérőszalag
D Rollbandmass RO Ruleta din pinza
PL Miara zwijana E Flexómetro
RUS Рулетка CN 卷尺
CZ Měřicí pásmo

3m
16mm

5m
19mm

8m
25mm

GRADE
II

NYLON
COATED



DISPLAY
BOX



2m
16mm

3m
16mm

5m
19mm

8m
25mm

10m
25mm

GRADE
II

NYLON
COATED



DOUBLE
BLISTER



| YATO | L (m) | size / rozmiar (mm) | PCS packing | |
|----------|-------|---------------------|----------------|--------|
| YT-71181 | 3 | 16 | 12 | 60/120 |
| YT-71182 | 5 | 19 | 12 | 36/72 |
| YT-71184 | 8 | 25 | 12 | 24/48 |

| YATO | L (m) | size / rozmiar (mm) | |
|----------|-------|---------------------|--------|
| YT-71185 | 2 | 16 | 12/144 |
| YT-71186 | 3 | 16 | 12/120 |
| YT-71187 | 5 | 19 | 12/72 |
| YT-71188 | 8 | 25 | 6/36 |
| YT-71189 | 10 | 25 | 6/36 |

GB Steel measuring tape H Acél mérőszalag
D Rollbandmass RO Ruleta sticla
PL Taśma miernicza stalowa E Cinta de medir de acero
RUS Мерная лента стальная CN 长钢卷尺
CZ Měřicí pásmo ocelové

20m
13mm

30m
13mm

50m
13mm

STEEL TAPE
TAŚMA STALOWA

SPEEDY
RETRACTING
SZYBSZE
ZWIJANIE

ABS



PAPER
HANGER



| YATO | L (m) | size / rozmiar (mm) | |
|----------|-------|---------------------|------|
| YT-71560 | 20 | 13 | 5/20 |
| YT-71561 | 30 | 13 | 5/20 |
| YT-71562 | 50 | 13 | 5/20 |

GB Fibreglass measuring tape H Mérőszalag - üvegszál
D Rollbandmass RO Ruleta fibra sticla
PL Taśma miernicza z włókna szklanego E Cinta de medir - fibra cristal
RUS Мерная лента фиберглас CN 长纤维卷尺
CZ Měřicí pásmo - skleněné vlákno

20m
15mm

30m
15mm

50m
13mm

FIBREGLASS TAPE
TAŚMA Z WŁÓKNA
SZKLANEGO

SPEEDY
RETRACTING
SZYBSZE
ZWIJANIE

ABS



PAPER
HANGER



| YATO | L (m) | size / rozmiar (mm) | |
|----------|-------|---------------------|------|
| YT-71565 | 20 | 15 | 5/20 |
| YT-71566 | 30 | 15 | 5/20 |
| YT-71567 | 50 | 15 | 5/20 |

GB Steel survey tape H Acél mérőszalag, geodéziiai
D Rollbandmass RO Bandă de măsură pt. geodezie
PL Miara geodezyjna stalowa E Cinta de medir de acero
RUS Мерная лента стальная CN 手提架式钢卷尺
CZ Měřicí pásmo ocelové geodetické

30m
13mm

50m
13mm

STEEL TAPE
TAŚMA STALOWA

ABS



COLOR BOX

| YATO | L (m) | size / rozmiar (mm) | |
|----------|-------|---------------------|----|
| YT-71551 | 30 | 13 | 10 |
| YT-71552 | 50 | 13 | 10 |

GB Fibreglass survey tape H Mérőszalag - üvegszál
D Rollbandmass RO Ruleta fibra sticla
PL Miara geodezyjna z włókna szklanego E Cinta de medir - fibra cristal
RUS Мерная лента фиберглас CN 手提架式纤维卷尺
CZ Měřicí pásmo - skleněné vlákno

30m
13mm

50m
13mm

FIBREGLASS TAPE
TAŚMA Z WŁÓKNA
SZKLANEGO

ABS



COLOR BOX

| YATO | L (m) | size / rozmiar (mm) | |
|----------|-------|---------------------|----|
| YT-71555 | 30 | 13 | 10 |
| YT-71556 | 50 | 13 | 10 |

GB Folding rule
 D Klappbares Massband
 PL Miara składana

RUS Метр складной
 CZ Měřicí pásmo skladané
 H Famérce

RO Metru armat
 E Metro plegable
 CN 木制折叠尺

1m
16mm

2m
16mm

GRADE III

WATER PROOF
ODPORNIA NA WODĘ

3.2 mm

SEGMENTS THICKNESS
GRUBOŚĆ LISTEWK





HANGING CARD

- non drilled segments - increased stiffness
- listewki nie przewiercane - zwiększona sztywność

UV PROOF
ODPORNIA NA PROMIENIOWANIE UV

LOCKING HINGES
ZAMIASY ZATRASZKOWE

| YATO  | L (m) | size / rozmiar (mm) |  |
|--|-------|---------------------|---|
| YT-7090 | 1 | 16 | 20/400 |
| YT-7091 | 2 | 16 | 10/200 |



GB Aluminium ruler
 D Alu zeichen-massstab
 PL Przymiar aluminiowy

RUS Линейка алюминиевая
 CZ Měřicí lat' hliníková
 H Asztalos vonalzó, aluminium

RO Riglă tâmplar din aluminiu
 E Regla de aluminio
 CN 铝合金直尺

Al



| YATO  | L (mm) |  |
|--|--------|---|
| YT-7070 | 300 | 25/100 |
| YT-7071 | 600 | 10/50 |

GB Aluminium try square
 D Anschlagwinkel
 PL Kątownik aluminiowy
 RUS Угольник столярный
 CZ Truhlářský úhelník
 H Asztalos derékszög
 RO Echer de tâmplărie
 E Escuadra de aluminio
 CN 铝合金角尺





Al

45°

90°





| YATO  | L (mm) |  |
|--|--------|---|
| YT-7080 | 250 | 6/36 |
| YT-7081 | 300 | 6/36 |
| YT-7082 | 350 | 6/36 |

GB Try square
 D Anschlagwinkel
 PL Kątownik stalowy
 RUS Угольник столярный
 CZ Truhlářský úhelník
 H Asztalos derékszög
 RO Echer de tâmplărie
 E Escuadra
 CN 不锈钢角尺



STAINLESS STEEL
STAL
NERDZEWNIA



| YATO  | size / rozmiar (mm) |  |
|--|---------------------|---|
| YT-7083 | 150 x 300 | 25/100 |
| YT-7084 | 250 x 500 | 10/50 |

GB Vernier caliper
 D Messschieber
 PL Suwmiarka
 RUS Штангенциркуль
 CZ Posuvné měřítko
 H Tolómérő
 RO Şubler
 E Calibre
 CN 游标卡尺



RANGE
0-150 mm

+/-
0.02 mm

SCALE
mm
inch

STAINLESS STEEL
STAL
NERDZEWNIA

PLASTIC CASE & COLOR BOX



| YATO  |  |
|--|---|
| YT-7200 | 10/50 |

GB Digital caliper
 D Digital Messschieber
 PL Suwmiarka elektroniczna
 RUS Штангенциркуль электронный
 CZ Posuvné měřítko elektronické
 H Elektronikus tolómérő
 RO Şubler electronic
 E Calibre electrónico
 CN 数显卡尺



RANGE
0-150 mm

+/-
0.03 mm

SCALE
mm
inch

BATTERY
SR44
1.55V

STAINLESS STEEL
STAL
NERDZEWNIA

PLASTIC CASE & COLOR BOX



| YATO  |  |
|--|---|
| YT-7201 | 10/50 |

- GB Laser distance meter
- D Laserentfernungsmesser
- PL Dalmierz laserowy
- RUS Лазерный дальномер
- CZ Laserový měřič vzdálenosti
- H Lézeres távolságmérő
- RO Telemetru cu laser
- E Medidores láser de distancias
- CN 激光测距仪

COLOR
BOX



| | | | |
|----------------------|--|------------------------|----------------------|
| 0.05-40m +/- 2 mm | | 20 MEMORY PAMIĘC | 8 MODES TRYBOW |
|----------------------|--|------------------------|----------------------|

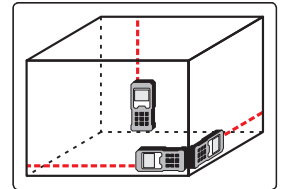
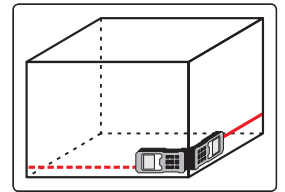
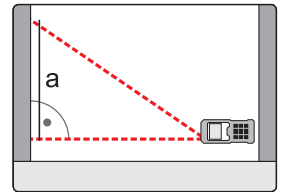
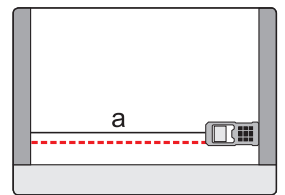

| | |
|-------------|----|
| YATO | |
| YT-73125 | 20 |



- GB Stud finder
- D Entfernungsmesser
- PL Wykrywacz profili i przewodów
- RUS Цифровой детектор
- CZ Digitální detektor
- H Digitális kereső műszer
- RO Detector digital
- E Escáner de pared
- CN 墙体探测仪

HANGING
COLOR
BOX



| | | |
|-------------|-----------------------------------|--|
| max. 100 mm | CALIBRATION AUTO KALIBRACJA | |
|-------------|-----------------------------------|--|

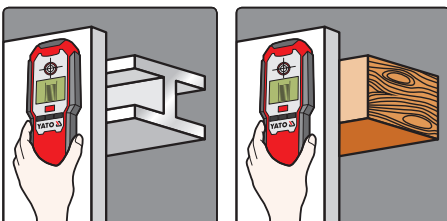
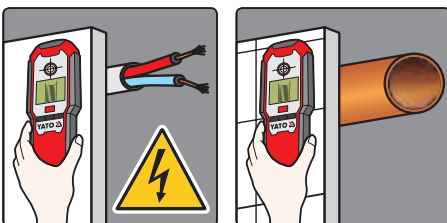

| | |
|-------------|----|
| YATO | |
| YT-73130 | 20 |

GB Aluminium level
 D Wasserwaage
 PL Poziomnica aluminiowa

RUS Уровень
 CZ Vodováha
 H Vízmérték

RO Cumpănă
 E Nivel
 CN 铝合金水平尺



SHOCK PROOF
 ODPORNA NA WSTRZASY

1.5 mm ALUMINIUM HIGH QUALITY PROFILE
 ALUMINIOWY PROFIL WYSOKIEJ JAKOŚCI

ACCURACY DOKŁADNOŚĆ
 0.057° = 1.0 mm/m

3 PRECISION VIALS LIBELKI



| YATO | L (mm) | |
|---------|--------|-------|
| YT-3001 | 400 | 20/60 |
| YT-3002 | 600 | 20/60 |
| YT-3003 | 800 | 20/60 |
| YT-3004 | 1000 | 20/60 |
| YT-3005 | 1200 | 20/60 |



| YATO | L (mm) | |
|---------|--------|-------|
| YT-3022 | 600 | 20/60 |
| YT-3023 | 800 | 20/60 |
| YT-3024 | 1000 | 30 |
| YT-3025 | 1200 | 30 |
| YT-3026 | 1500 | 30 |

GB Feeler
 D Fühlerlehre
 PL Szczelinomierz
 RUS Щупы
 CZ Spároměr

H Hézagmérő
 RO Lere
 E Calibre de fisuras
 CN 塞尺

DOUBLE BLISTER



100 mm 10 mm 17 GAUGES LISTKÓW TAPER ZBIEŻNY

200 mm 12.8 mm 17 GAUGES LISTKÓW PARALLEL RÓWNOLEGŁY

| YATO | L (mm) | width / szerokość | size / rozmiar | |
|---------|--------|-------------------|--|--------|
| YT-7220 | 100 | 10 | 0.02, 0.03, 0.04, 0.05, 0.06, 0.07, 0.08, 0.09, 0.10, 0.15, 0.20, 0.25, 0.30, 0.40, 0.50, 0.75, 1.00 | 10/200 |

| YATO | L (mm) | width / szerokość | size / rozmiar | |
|---------|--------|-------------------|--|--------|
| YT-7221 | 200 | 12.8 | 0.02, 0.03, 0.04, 0.05, 0.06, 0.07, 0.08, 0.09, 0.10, 0.15, 0.20, 0.25, 0.30, 0.40, 0.50, 0.75, 1.00 | 10/100 |



100 mm 10 mm 10 GAUGES LISTKÓW TAPER ZBIEŻNY

200 mm 12.8 mm 14 GAUGES LISTKÓW PARALLEL RÓWNOLEGŁY

| YATO | L (mm) | width / szerokość | size / rozmiar | |
|---------|--------|-------------------|--|--------|
| YT-7222 | 100 | 10 | 0.05, 0.06, 0.07, 0.08, 0.09, 0.10, 0.20, 0.30, 0.40, 0.50 | 10/100 |

| YATO | L (mm) | width / szerokość | size / rozmiar | |
|---------|--------|-------------------|--|--------|
| YT-7223 | 200 | 12.8 | 0.05, 0.06, 0.07, 0.08, 0.09, 0.10, 0.15, 0.20, 0.25, 0.30, 0.35, 0.40, 0.45, 0.50 | 10/100 |

Memo

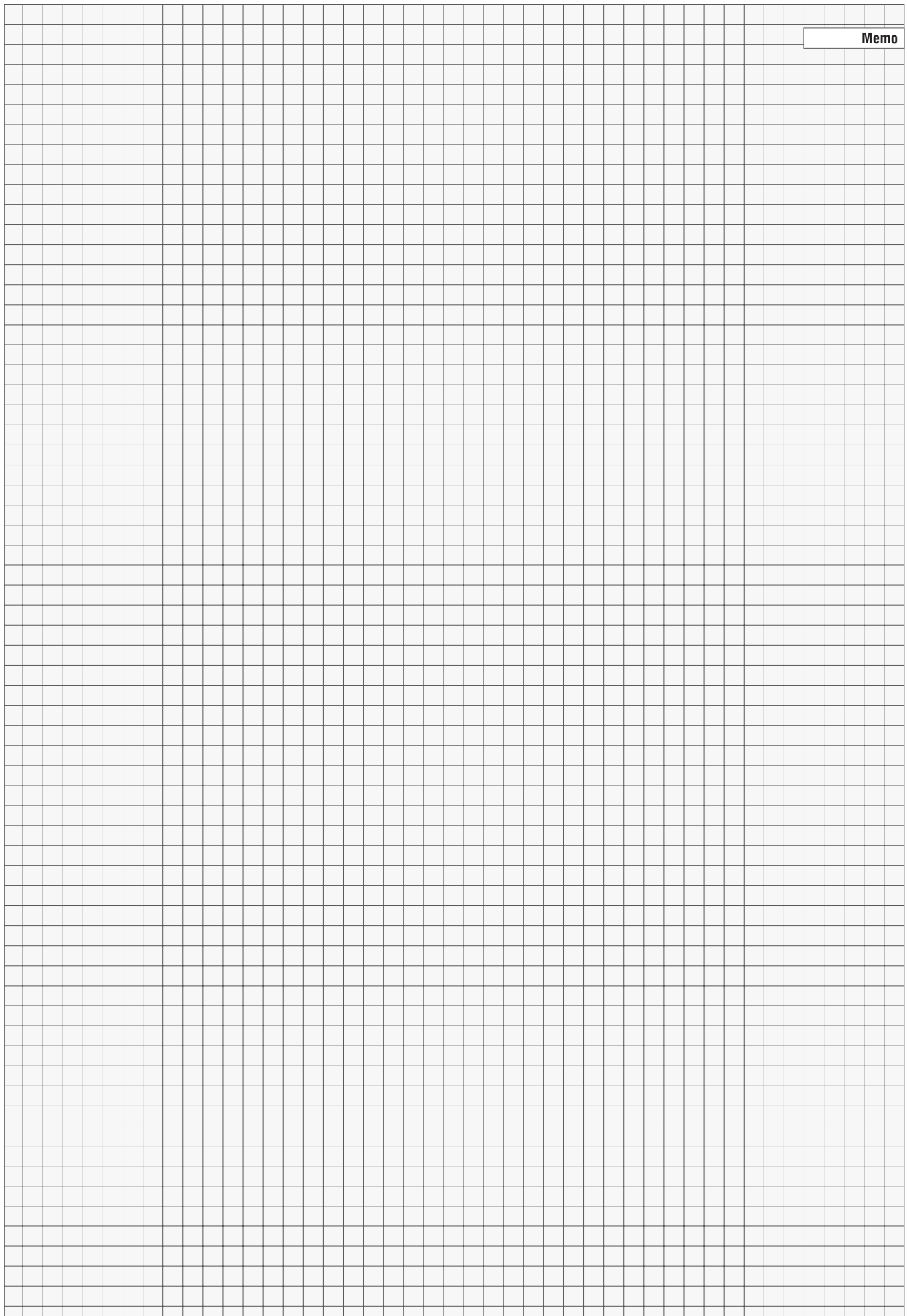

15

Pneumatic tools Narzędzia pneumatyczne



| | | |
|--|---|---------|
| Impact wrenches Klucze udarowe |  | 252-254 |
|--|---|---------|

| | |
|--|-----|
| Impact wrenches 3/8" Klucze udarowe 3/8" | 252 |
| Impact wrenches 1/2" Klucze udarowe 1/2" | 252 |
| Impact wrenches 3/4" Klucze udarowe 3/4" | 253 |
| Impact wrenches 1" Klucze udarowe 1" | 254 |

| | | |
|---|---|---------|
| Other air tools Inne narzędzia pneumatyczne |  | 255-257 |
|---|---|---------|

| | |
|---|-----|
| Pneumatic ratchets & sets Grzechotki pneumatyczne i zestawy | 255 |
| Pneumatic grinders Szlifierki pneumatyczne | 255 |
| Pneumatic cut-off tools & discs Przecinarki pneumatyczne i tarcze | 256 |
| Pneumatic drills Wiertarki pneumatyczne | 256 |
| Pneumatic hammers Młotki pneumatyczne | 256 |
| Tire inflating guns & heads Pistolety do pompowania kół i głowice | 257 |

| | | |
|---|--|---------|
| Painting equipment Narzędzia do malowania |  | 257-258 |
|---|--|---------|

| | |
|--|-----|
| Spray guns Pistolety lakiernicze | 257 |
| Accessories for spray guns Akcesoria do pistoletów lakierniczych | 257 |
| Inflating guns Pistolety do przedmuchiwania | 258 |
| Washing guns Pistolety do ropowania | 258 |
| Air sand blasters Pistolety do piaskowania | 258 |

| | | |
|--|---|-----|
| Pneumatic accessories Akcesoria instalacji pneumatycznej |  | 259 |
|--|---|-----|

| | |
|--|-----|
| Air filters, regulators & lubricators Filtry, reduktory i smarownice | 259 |
| Couplers Złącza | 259 |

| | | |
|---|---|-----|
| Pneumatic riveters Nitownice pneumatyczne |  | 260 |
|---|---|-----|

| | | |
|---|---|---------|
| Pneumatic stitching & nailing machines Zszywacze i gwoździarki pneumatyczne |  | 260-261 |
|---|---|---------|

| | |
|--|-----|
| Pneumatic staplers Zszywacze pneumatyczne | 260 |
| Pneumatic nailers Gwoździarki pneumatyczne | 260 |

| | | |
|--|---|-----|
| Mini palm nailers Młotki pneumatyczne do gwoździ |  | 261 |
|--|---|-----|

GB Impact wrench
D Druckluft-Schlagschrauber
PL Klucz pneumatyczny
RUS Ударный пневматический гайковерт

CZ Klúč pneumatický
H Pneumatikus ütvecsavarozó
RO Pistol pneumatic
E Llave neumática de percusión
CN 气动扳手

3/8"
10mm

TWIN HAMMER TYPE

COMPOSITE BODY
KOMPOZITOWA OBLUDOWA

0.63 MPa **142 l/min**

400 Nm **10000 min⁻¹**

1/4"
6.3mm



TWIN HAMMER™
mechanism
ensuring resilience
to damage and
overload

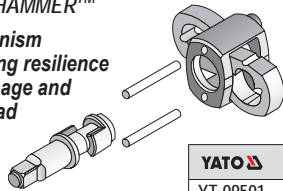

COLOR BOX



| YATO | Nm | Box |
|----------|-----|-----|
| YT-09501 | 400 | 10 |

GB Impact wrench
D Druckluft-Schlagschrauber
PL Klucz pneumatyczny
RUS Ударный пневматический гайковерт

CZ Klúč pneumatický
H Pneumatikus ütvecsavarozó
RO Pistol pneumatic
E Llave neumática de percusión
CN 气动扳手

1/2"
12.5mm

TWIN HAMMER TYPE

0.62 MPa **105 l/min**

540 Nm **7000 min⁻¹**

1/4"
6.3mm



TWIN HAMMER™
mechanism
ensuring resilience
to damage and
overload

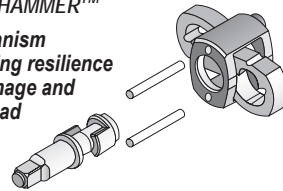

COLOR BOX



| YATO | Nm | Box |
|---------|-----|-----|
| YT-0952 | 540 | 8 |

GB Impact wrench
D Druckluft-Schlagschrauber
PL Klucz pneumatyczny
RUS Ударный пневматический гайковерт

CZ Klúč pneumatický
H Pneumatikus ütvecsavarozó
RO Pistol pneumatic
E Llave neumática de percusión
CN 气动扳手

1/2"
12.5mm

TWIN HAMMER TYPE

COMPOSITE BODY
KOMPOZITOWA OBLUDOWA

0.63 MPa **142 l/min**

570 Nm **10000 min⁻¹**

1/4"
6.3mm



TWIN HAMMER™
mechanism
ensuring resilience
to damage and
overload

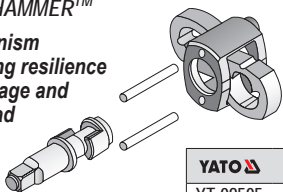

COLOR BOX



| YATO | Nm | Box |
|----------|-----|-----|
| YT-09505 | 570 | 10 |

GB Impact wrench
D Druckluft-Schlagschrauber
PL Klucz pneumatyczny
RUS Ударный пневматический гайковерт

CZ Klúč pneumatický
H Pneumatikus ütvecsavarozó
RO Pistol pneumatic
E Llave neumática de percusión
CN 气动扳手

1/2"
12.5mm

TWIN HAMMER TYPE

COMPOSITE BODY
KOMPOZITOWA OBLUDOWA

0.63 MPa **480 l/min**

1356 Nm **10000 min⁻¹**

1/4"
6.3mm



TWIN HAMMER™
mechanism
ensuring resilience
to damage and
overload

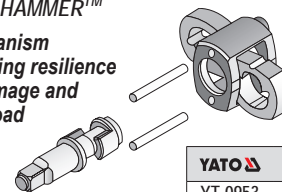

COLOR BOX



| YATO | Nm | Box |
|---------|------|-----|
| YT-0953 | 1356 | 10 |

- GB Impact wrench
- D Druckluft-Schlagschrauber
- PL Klucz pneumatyczny
- RUS Ударный пневматический гайковерт
- CZ Klíč pneumatický
- H Pneumatikus ütvecsavarozó
- RO Pistol pneumatic
- E Llave neumática de percusión
- CN 气动扳手



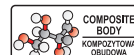

| | |
|---|----------------------------|
| 1/2" 12.5mm | TWIN HAMMER TYPE |
| 0.63 MPa | 153 l/min |
| 1150 Nm | 10000 min ⁻¹ |
|  | |



COMPOSITE BODY
KOMPOZYTOWA OBUDOWA



COLOR BOX

| YATO  | Nm |  |
|--|------|---|
| YT-09540 | 1150 | 10 |



TWIN HAMMER™
mechanism
ensuring resilience
to damage and
overload

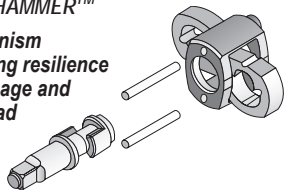



- GB Impact wrench
- D Druckluft-Schlagschrauber
- PL Klucz pneumatyczny
- RUS Ударный пневматический гайковерт
- CZ Klíč pneumatický
- H Pneumatikus ütvecsavarozó
- RO Pistol pneumatic
- E Llave neumática de percusión
- CN 气动扳手



| | |
|---|---------------------------|
| 3/4" 19mm | DYNA PACT TYPE |
| 0.62 MPa | 450 l/min |
| 945 Nm | 4500 min ⁻¹ |
|  | |



COLOR BOX

| YATO  | Nm |  |
|--|-----|---|
| YT-0956 | 945 | 4 |

DYNA-PACT™

mechanism
ensuring resilience
to damage and
overload



- GB Impact wrench
- D Druckluft-Schlagschrauber
- PL Klucz pneumatyczny
- RUS Ударный пневматический гайковерт
- CZ Klíč pneumatický
- H Pneumatikus ütvecsavarozó
- RO Pistol pneumatic
- E Llave neumática de percusión
- CN 气动扳手



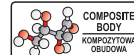

| | |
|---|---------------------------|
| 3/4" 19mm | TWIN HAMMER TYPE |
| 0.63 MPa | 198 l/min |
| 1630 Nm | 5500 min ⁻¹ |
|  | |



COMPOSITE BODY
KOMPOZYTOWA OBUDOWA



COLOR BOX

| YATO  | Nm |  |
|--|------|---|
| YT-09571 | 1630 | 6 |



TWIN HAMMER™
mechanism
ensuring resilience
to damage and
overload

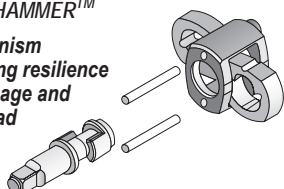

GB Pneumatic wrench
D Druckluft-Schlüssel
PL Klucz pneumatyczny
RUS Пневматический ключ
CZ Pneumatický uťahovák

H Pneumatikus kulcs
RO Cheie pneumatica
E Llave neumática
CN 气动扳手

| | | | |
|------------|------------------------|----------------|-----------|
| 1" 25mm | PINLESS HAMMER TYPE | 0.63 MPa | 560 l/min |
| 2600 Nm | 4000 min ⁻¹ | 1/2" 12.5mm | |

PINLESS HAMMER™

closed hammer cage mechanism prevents breakage from hammer pin damage

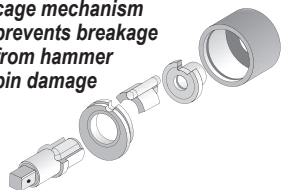

- application: automotive service stations, trucks
- *przeznaczenie: serwis, samochody ciężarowe*
- strong, uniform impact
- *silny, jednolity udar*



BMC & COLOR SLEEVE



| | | |
|-------------|------|---|
| YATO | Nm | |
| YT-0959 | 2600 | 2 |

GB Pneumatic wrench
D Druckluft-Schlüssel
PL Klucz pneumatyczny
RUS Пневматический ключ
CZ Pneumatický uťahovák

H Pneumatikus kulcs
RO Cheie pneumatica
E Llave neumática
CN 气动扳手

| | | | |
|------------|------------------------|----------------|-----------|
| 1" 25mm | PINLESS HAMMER TYPE | 0.63 MPa | 560 l/min |
| 2600 Nm | 4000 min ⁻¹ | 1/2" 12.5mm | |

PINLESS HAMMER™

closed hammer cage mechanism prevents breakage from hammer pin damage

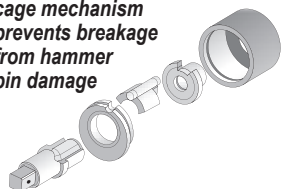

- application: automotive service stations, trucks
- *przeznaczenie: serwis, samochody ciężarowe*
- strong, uniform impact
- *silny, jednolity udar*



BMC & COLOR SLEEVE



| | | |
|-------------|------|---|
| YATO | Nm | |
| YT-0960 | 2600 | 2 |

GB Pneumatic wrench
D Druckluft-Schlüssel
PL Klucz pneumatyczny
RUS Пневматический ключ
CZ Pneumatický uťahovák

H Pneumatikus kulcs
RO Cheie pneumatica
E Llave neumática
CN 气动扳手

| | | | |
|-----------------------|----------------------------------|---------------|------------------------|
| 1" 25mm | TWIN HAMMER TYPE | 0.63 MPa | 380 l/min |
| 7.6 kg ULTRA LIGHT | COMPOSITE BODY MAGNESIUM HOUSING | 2800 Nm | 4800 min ⁻¹ |
| | | 1/4" 6.3mm | 1/2" 12.5mm |

- application: industry, service stations, tire service stations, truck service
- the lightest 1" impact wrench with torque of 2800 Nm
- magnesium alloy and composite housing
- low vibration
- low air consumption
- *przeznaczenie: przemysł, serwisy mobilne i stacjonarne, serwisy opon oraz pojazdów ciężarowych*
- najlżejszy klucz pneumatyczny w klasie 1" o mocy 2800 Nm
- obudowa ze stopów magnezu i kompozytu
- niski poziom wibracji
- małe zużycie powietrza

TWIN HAMMER™

mechanism ensuring resilience to damage and overload

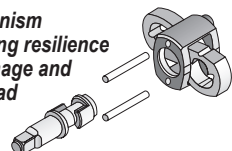

- Durable twin hammer mechanism
Mechanizm udarowy typu TWIN HAMMER
- Humanized special changeable supports handle for left-hander purpose
Rękojeść pomocnicza (prawa lub lewa strona)
- Setting with 3 forward and 3 reverse speed
Trójstopniowy regulator mocy

- Magnesium hammer housing
Obudowa z magnezu
- Unique composite motor housing
Obudowa kompozytowa
- Elastomer composite handle grip
Kompozytowa rękojeść
- Tigger with 2 speed control
Włącznik z dwustopniową regulacją prędkości
- Two way changeable air inlet direction for comfort workplace
Alternatywne gniazda przyłączeniowe

COLOR BOX



| | | |
|-------------|------|---|
| YATO | Nm | |
| YT-0961 | 2800 | 2 |

- GB Ratchet air wrench
D Druckluft-Ratschenschrauber
PL Grzechotka pneumatyczna
RUS Пневмотрещотка
CZ Utahovák vzduchový
H Préslevegős behajtó szerszám
RO Antrenor pneumatic
E Carraca neumática
CN 气动棘轮扳手



COLOR BOX

| | | |
|----------------|--------------------------|---------------|
| 1/2" 12.5mm | 0.62 MPa | 120 l/min |
| 80 Nm | 160 min ⁻¹ | 1/4" 6.3mm |

| | | |
|-------------|----|----|
| YATO | Nm | |
| YT-0981 | 80 | 20 |

- GB Ratchet air wrench
D Druckluft-Ratschenschrauber
PL Grzechotka pneumatyczna
RUS Пневмотрещотка
CZ Utahovák vzduchový
H Préslevegős behajtó szerszám
RO Antrenor pneumatic
E Carraca neumática
CN 气动棘轮扳手



COLOR BOX

| | | |
|----------------|--------------------------|---------------|
| 1/2" 12.5mm | 0.62 MPa | 110 l/min |
| 68 Nm | 160 min ⁻¹ | 1/4" 6.3mm |

| | | |
|-------------|----|----|
| YATO | Nm | |
| YT-0980 | 68 | 20 |

- GB Ratchet wrench kit
D Druckluft-Ratschenschrauber mit Zubehör
PL Zestaw z grzechotką pneumatyczną
RUS Пневмотрещотка в наборе
CZ Klíč ráčnový pneumatický s příslušenstvím
H Pneumatikus racsnikulcs készlet
RO Cheie pneumatica cu accesorii
E Juego con carraca neumática
CN 气动棘轮扳手组套



- 1/2" (12.7 mm), L=75 mm;
- 6 mm x 1/2" (12.7 mm);
- 1/2" (12.7 mm);
- H4, H5, H6, H7, H8;
- T20, T25, T27, T30, T40;
- 5.5, 6.5, 8.0 mm;
- PH2, PH3, PH4;
- 10, 11, 12, 13, 14, 17, 19 mm

| | |
|----------------|--------------------------|
| 1/2" 12.5mm | OILER POT |
| 0.62 MPa | 110 l/min |
| 68 Nm | 160 min ⁻¹ |
| 1/4" 6.3mm | CrV |

| | | |
|-------------|----|---|
| YATO | Nm | |
| YT-0982 | 68 | 4 |

BMC & COLOR SLEEVE



- GB Air grinder
D Druckluft-Excenterschleifer
PL Szlifierka pneumatyczna prosta
RUS Шлифмашинка пневматическая
CZ Bruska přímá pneumatická
H Préslevegős sarokcsiszoló
RO Polizor pneumatic
E Lijadora neumática recta
CN 气动修磨机



COLOR BOX

| | |
|---------------------------|---------------|
| 0.62 MPa | 160 l/min |
| 2000 min ⁻¹ | 3 6mm |
| | 1/4" 6.3mm |

| | |
|-------------|----|
| YATO | |
| YT-0965 | 25 |

- GB Air sander
D Druckluft-Excenterschleifer
PL Szlifierka pneumatyczna mimośrodowa
RUS Шлифмашинка эксцентриковая пневматическая
CZ Bruska pneumatická
H Pneumatikus sarokcsiszológép
RO Masina de slefuit pneumatica
E Lijadora neumática excéntrica
CN 气动砂磨机



COLOR BOX

| | |
|---------------------------|---------------|
| 0.62 MPa | 230 l/min |
| 9000 min ⁻¹ | mm |
| ECCENTRIC | 1/4" 6.3mm |

| | |
|-------------|----|
| YATO | |
| YT-0967 | 10 |

GB Air sander
 D Druckluft-Excenterschleifer
 PL Szlifierka pneumatyczna oscylacyjna
 RUS Шлифмашина эксцентриковая пневматическая
 CZ Bruska pneumatická
 H Pneumatikus sarokcsiszológép
 RO Masina de slefuit pneumatica
 E Lijadora neumática excéntrica
 CN 气动三角形砂磨机

0.62 MPa
 71 l/min
 10000 min⁻¹
 VACUUM SYSTEM SYSTEM ODPYLANIA
 143x99 mm
 1/4"
 6.3mm



YATO
 YT-0976 10

GB Air sander
 D Druckluft-Excenterschleifer
 PL Szlifierka pneumatyczna oscylacyjna
 RUS Шлифмашина эксцентриковая пневматическая
 CZ Bruska pneumatická
 H Pneumatikus sarokcsiszológép
 RO Masina de slefuit pneumatica
 E Lijadora neumática excéntrica
 CN 气动三角形砂磨机

0.62 MPa
 71 l/min
 10000 min⁻¹
 VACUUM SYSTEM SYSTEM ODPYLANIA
 130x80 mm
 1/4"
 6.3mm



YATO
 YT-0977 10

GB Air cut-off tool
 D Druckluft-Schneidmaschine
 PL Przecinarka pneumatyczna
 RUS Резак пневматический
 CZ Příčná bruska pneumatická

H Pneumatikus sarokcsiszoló
 RO Masina de taiat cu aer comprimat
 E Cortadora neumática
 CN 气动切割工具

0.62 MPa
 160 l/min
 18000 min⁻¹
 75 mm
 6.4 mm
 1/4"
 6.3mm



YATO
 YT-0993 20

GB Metal cutting disc
 D Metall-Trennscheibe
 PL Tarcza do cięcia metalu
 RUS Круги отрезные по металлу
 CZ Souprava kotoučů pro řezání kovů
 H Vágókorong fémhez
 RO Set de pânze de tăiat metal
 E Disco cortador para metal
 CN 金属切割片组套

for / dla: YT-0993

5 PCS
 75 mm
 2 mm
 9.5 mm
 18000 min⁻¹



YATO
 YT-0994 12/48

GB Reversible air drill
 D Druckluft-Bohrmaschine mit Stahl-Zahnkranzfutter
 PL Wiertarka pneumatyczna
 RUS Пневматическая дрель
 CZ Vrtáčka ruční vzduchová

H Préslevegős fűrógép
 RO Masina de gaurit pneumatica mandrina
 E Taladradora neumática
 CN 双向气钻

0.62 MPa
 180 l/min
 0-1800 min⁻¹
 max. 10 mm
 1/4"
 6.3mm



YATO
 YT-0970 20

GB Air hammer
 D Druckluft-Schlaghammer
 PL Młotek pneumatyczny
 RUS Зубило пневматическое
 CZ Sekáč vzduchový

H Pneumatikus vésőkészlet pisztollyal
 RO Ciosam cu aer comprimat
 E Martillo neumático
 CN 气锤

0.62 MPa
 110 l/min
 3200 min⁻¹
 1/4"
 6.3mm



YATO
 YT-0990 10

- GB Tire-inflating gun
D Reifenfüller
PL Pistolet do pompowania kół
RUS Пистолет для накачивания колёс
CZ Pistolet na čerpaní z manometrem
H Gumiabroncs pumpáló
RO Pistol cu manometru pt. pompat
E Pistola de bombeo con manometro
CN 轮胎气压表



| | |
|-----------------|----------------|
| 1/4" | 0.8 MPa (max.) |
| 6.3mm | |
| 440mm HOSE W/AV | AI |



SLIDING CARD

| | |
|---|---|
| YATO  |  |
| YT-2370 | 8/40 |



- GB Inflating head
D Klemmnippel (universal)
PL Głowica do pompowania
RUS Универсальная головка
CZ Hlava na čerpaní
H Pumpafej
RO Cap pt. pompat
E Cabeza de bombeo
CN 充气头



DOUBLE BLISTER



| |
|----------------|
| 1.0 MPa (max.) |
|----------------|

| | | |
|---|--------|---|
| YATO  | Ø (mm) |  |
| YT-2371 | 6 | 50/300 |
| YT-2372 | 8 | 50/300 |

- GB Spray gun with fluid cup
D Lackierpistole mit Fließbecher
PL Pistolet natryskowy

- RUS Пистолет - распылитель с верхним бачком
CZ Pistolet na lakování z nádrží

- H Festöpisztoly alsó tartállyal
RO Pistol de vopsit cu rezervor inferior

- E Pistola de barniz
CN 喷枪

COLOR BOX



| | | |
|----------|-----------|-------|
| Ø 1.4 mm | 410 l/min | 0.6 l |
| | 0.30 MPa | HVLP |

| | |
|---|---|
| YATO  |  |
| YT-2340 | 20 |



| | | |
|----------|-----------|-------|
| Ø 1.5 mm | 410 l/min | 0.6 l |
| | 0.30 MPa | HVLP |

| | |
|---|---|
| YATO  |  |
| YT-2341 | 20 |



| | | |
|----------|-----------|----------|
| Ø 1.8 mm | 380 l/min | 0.40 MPa |
| | 1.0 l | |

| | |
|---|---|
| YATO  |  |
| YT-2346 | 10 |



| | | |
|----------|-----------|-------|
| Ø 0.8 mm | 220 l/min | 0.1 l |
| | 0.30 MPa | HVLP |

| | |
|---|---|
| YATO  |  |
| YT-2357 | 20 |

- GB Plastic tank
D Fließbecher für Spritzpistole
PL Zbiornik plastikowy
RUS Пластмассовый бачок
CZ Plastová nádrž
H Műanyag tartály
RO Rezervor de plastic
E Recipiente de plástico
CN 喷枪附件



| |
|-------|
| 0.1 l |
|-------|

COLOR BOX



| | |
|---|---|
| YATO  |  |
| YT-2364 | 100 |

- GB Nozzle set
D Düsen-Reparatur-Satz
PL Zestaw naprawczy dysz
RUS Комплект дюз для покрасочных пистолетов
CZ Soustava na opravování trysek
H Fűvókajavító készlet
RO Set pt. reparații diuze
E Juego de reparación para toberas
CN 喷嘴附件

for / dla: YT-2350

| |
|----------|
| Ø 1.4 mm |
|----------|



COLOR BOX



| | |
|---|---|
| YATO  |  |
| YT-2361 | 80 |

- GB Inflating gun with extension
- D Gebläsepistole mit Verlängerung
- PL Pistolet do przedmuchiwania z przedłużką
- RUS Пистолет для продувки с удлинителем
- CZ Pistole na profukování dlouhá
- H Rövid előfűvő pisztoly
- RO Pistol lung pt. suflat
- E Pistola de soplado
- CN 长杆充气枪



1/4"
6.3mm

0.8
MPa
(max.)

AI

SLIDING
CARD

YATO

YT-2373

20/40

- GB Washing gun
- D Waschpistole
- PL Pistolet do gorowania
- RUS Пистолет для нефтewания
- CZ Pistole na gorování + nádrž
- H Olajzópisztoly + tartály
- RO Pistol (dozator) cu rezervor pt. motorină
- E Pistola de petrolear
- CN 喷水枪



0.85l

130
l/min

AI

0.80
MPa

COLOR
BOX

YATO

YT-2374

2/12

- GB Air sand blaster
- D Pistole zum Sandstrahlen
- PL Pistolet do piaskowania z węzłem
- RUS Пескоструйный пистолет
- CZ Pískovací pistole s hadicí
- H Homokszóró pisztoly tömlővel
- RO Pistol de sablat
- E Pistola para limpieza con chorro de arena con manguera
- CN 吹气枪

1/4"
6.3mm

∅
6.3 mm

160
l/min

1m
HOSE
WAZ

AI

0.80
MPa

- GB Gun suitable for sand-blasting
- D Sandstrahlpistole
- PL Pistolet do piaskowania ze zbiornikiem
- RUS Пескоструйный пистолет
- CZ Pískovací pistole se zásobníkem
- H Homokszóró pisztoly tartállyal
- RO Pistol de sablat
- E Pistola para limpieza con chorro de arena con recip
- CN 喷枪

1.0l

160
l/min

AI

0.80
MPa



SLIDING
CARD

YATO

YT-2375

10



COLOR
BOX

YATO

YT-2376

20

GB Mini filter
D Filter
PL Filtr
RUS Минифильтр
CZ Filtr
H Szűrő
RO Minifiltru
E Filtro
CN 微型过滤器



1.4 MPa (max.)

8 cm³

1/4" 6.3mm

YATO
YT-2380 25/50

GB Pressure reducing valve with manometer
D Druckminderer mit Manometer
PL Reduktor ciśnienia z manometrem
RUS Клапан уменьшения давления с манометром
CZ Redukční ventil s manometrem
H Nyomáscsökkentő szelep nyomásmérővel
RO Valva cu reductiepresiune + manometru
E Reductor + manometro
CN 带表调压减压阀



1.2 MPa (max.)

1/4" 6.3mm

YATO
YT-2381 25/50

GB Filter - reducer
D Druckfilter - Druckminderer
PL Filtr - reduktor
RUS Фильтр - редуктор
CZ Filtr derukční ventil
H Szűrő - nyomáscsökkentő
RO Filtru cu reductor
E Reductor + filtro
CN 过滤器



0.93 MPa (max.)

15 cm³

60°C max.

1/4" 6.3mm

YATO
YT-2382 25/50

GB Filter - reducer
D Druckfilter - Druckminderer
PL Filtr - reduktor
RUS Фильтр - редуктор
CZ Filtr derukční ventil
H Szűrő - nyomáscsökkentő
RO Filtru cu reductor
E Reductor + filtro
CN 过滤器



0.93 MPa (max.)

90 cm³

60°C max.

1/2" 12.5mm

YATO
YT-2383 25/50

GB Air filter regulator and lubricator
D Druckfilter - Druckminderer + Entöler
PL Zespół filtrujący reduktor + smarownica
RUS Фильтр-редуктор
CZ Redukční ventil s odlučovačem oleje
H Levegőelőkészítő
RO Filtru cu reductor
E Juego de filtro reductor + engrasador
CN 气动三联件



0.93 MPa (max.)

25 cm³ FILTER FILTER

15 cm³ LUBRICANT CUP SMAROWNICA

60°C max.

1/4" 6.3mm

YATO
YT-2384 25/50

GB Air filter regulator and lubricator
D Druckfilter - Druckminderer + Entöler
PL Zespół filtrujący reduktor + smarownica
RUS Фильтр-редуктор
CZ Redukční ventil s odlučovačem oleje
H Levegőelőkészítő
RO Filtru cu reductor
E Juego de filtro reductor + engrasador
CN 气动三联件



0.93 MPa (max.)

90 cm³ FILTER FILTER

60°C max.

1/4" 6.3mm

YATO
YT-2385 25

GB Quick coupler
D Schnellkupplung
PL Szybkozłącze
RUS Быстрое соединение
CZ Rychlospojka



1/4"

3/8"

1/2"

1/4"

| YATO | size / rozmiar | |
|---------|----------------|--------|
| YT-2390 | 1/4" (6.3 mm) | 50/250 |
| YT-2391 | 3/8" (10.0 mm) | 50/250 |
| YT-2392 | 1/2" (12.5 mm) | 50/250 |

H Gyorscsatlakozó
RO Mufa rapida pt. pistol pneumatic
E Conexión de la entrada de aire
CN 快速接头



1/4"

3/8"

1/2"

1/4"

| YATO | size / rozmiar | |
|---------|----------------|--------|
| YT-2393 | 1/4" (6.3 mm) | 50/250 |
| YT-2394 | 3/8" (10.0 mm) | 50/250 |
| YT-2395 | 1/2" (12.5 mm) | 50/250 |

SLIDING CARD



1/4"

3/8"

1/2"

1/4"

| YATO | size / rozmiar | |
|---------|----------------|--------|
| YT-2396 | 1/4" (6.3 mm) | 50/250 |
| YT-2397 | 3/8" (10.0 mm) | 50/250 |
| YT-2398 | 1/2" (12.5 mm) | 50/250 |



1/4"

3/8"

1/2"

1/4"

| YATO | size / rozmiar | |
|---------|----------------|--------|
| YT-2399 | 1/4" (6.3 mm) | 50/250 |
| YT-2401 | 3/8" (10.0 mm) | 50/250 |
| YT-2402 | 1/2" (12.5 mm) | 50/250 |



1/4"

3/8"

1/4"

| YATO | size / rozmiar | |
|---------|----------------|--------|
| YT-2403 | 1/4" (6.3 mm) | 50/250 |
| YT-2404 | 3/8" (10.0 mm) | 50/250 |



1/4"

3/8"

1/2"

1/4"

| YATO | size / rozmiar | |
|---------|----------------|--------|
| YT-2405 | 1/4" (6.3 mm) | 50/250 |
| YT-2406 | 3/8" (10.0 mm) | 50/250 |
| YT-2407 | 1/2" (12.5 mm) | 50/250 |

GB Pneumatic riveting machine
 D Pneumatische Nietvorrichtung
 PL Nitownica pneumatyczna
 RUS Пневматический заклепочник
 CZ Pneumatická nýtovačka

H Pneumatikus popszegecsűző
 RO Presa pneumatica de nituri
 E Máquina remachadora
 CN 气动拉铆枪

COLOR
BOX



x4 • application: industry
 • przeznaczenie: przemysł

x5 • application: industry
 • przeznaczenie: przemysł

| YATO | Ø (mm) | L (mm) | F (kg) | F (N) | Box |
|---------|--------------------|--------|--------|-------|-----|
| YT-3617 | 2.4; 3.2; 4.0; 4.8 | 14 | 850 | 8335 | 10 |

| YATO | Ø (mm) | L (mm) | F (kg) | F (N) | Box |
|---------|-------------------------|--------|--------|-------|-----|
| YT-3618 | 2.4; 3.2; 4.0; 4.8; 6.4 | 16 | 1389 | 13620 | 6 |

GB Pneumatic stitching machine
 D Drucklufthefter
 PL Zszywacz pneumatyczny
 RUS Пневматический шиватель
 CZ Pneumatická sešíváčka
 H Pneumatikus tűzőgép
 RO Capsator pneumatic
 E Engrapadora pneumática
 CN 气动码钉枪



GB Pneumatic nailing machine
 D Druckluftnagelgerät
 PL Gwoździarka pneumatyczna
 RUS Пневматическая гвоздильная машина
 CZ Pneumatický nástřelovač hřebíků
 H Pneumatikus szögbelevő
 RO Capsator pneumatic
 E Máquina pneumática para clavar clavos
 CN 气动码钉枪

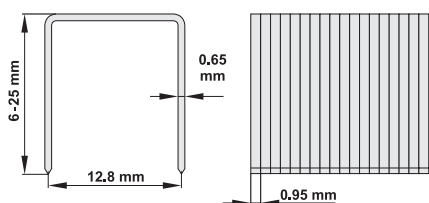
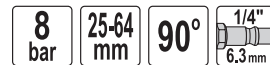

• application: industry, construction
 • przeznaczenie: przemysł, budownictwo

| YATO | Box |
|---------|-----|
| YT-0920 | 5 |

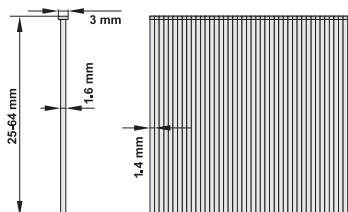

• application: industry, construction
 • przeznaczenie: przemysł, budownictwo

| YATO | Box |
|---------|-----|
| YT-0921 | 5 |

- GB Pneumatic nailing machine
- D Druckluftnagelgerät
- PL Gwoździarka pneumatyczna
- RUS Пневматическая гвоздильная машина
- CZ Pneumatický nástřelovač hřebíků
- H Pneumatikus szögbeütő
- RO Capsator pneumatic
- E Máquina pneumática para clavar clavos
- CN 气动码钉枪

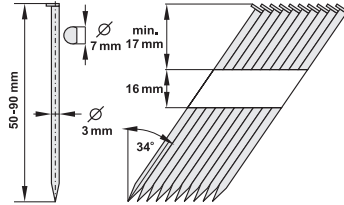

- application: industry, construction
- przeznaczenie: przemysł, budownictwo



| | | | |
|-------|----------|-----|---------------|
| 8 bar | 50-90 mm | 34° | 1/4" / 6.3 mm |
|-------|----------|-----|---------------|



BMC & COLOR SLEEVE

| | |
|-------------|---|
| YATO |  |
| YT-0923 | 2 |

- GB Mini palm nailer
- D Drucklufthammer für Nägel
- PL Młotek pneumatyczny do gwoździ
- RUS Пневматический молоток для забивания гвоздей
- CZ Pneumatická hřebíkovačka
- H Pneumatikus szögbeütő kalapács
- RO Ciocan pneumatic pt. cuie
- E Máquina pneumática para clavar clavos
- CN 迷你气动钉枪

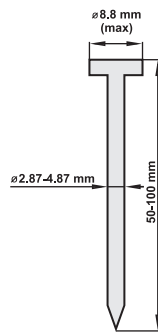

| | |
|----------|---------------|
| 0.70 MPa | 1/4" / 6.3 mm |
|----------|---------------|



COLOR BOX

| | |
|-------------|---|
| YATO |  |
| YT-0925 | 20 |















Memo

16

**Special automotive tools
& equipment**

**Narzędzia i wyposażenie
warsztatu samochodowego**



| | | | | | |
|--|---|---|--|---|---------|
| Cabinets Szafki |  | 265-269 | Brake system tools Narzędzia do obsługi układu hamulcowego |  | 307-311 |
| Roller cabinets with tools insert Szafki serwisowe z narzędziami | 265 | Suspension system tools Narzędzia do obsługi podwozia |  | 312-315 | |
| Tool cabinets Szafki serwisowe | 265 | Spring clamps & accessories Ściągacze do sprężyn i akcesoria | 312 | | |
| Tools in PVC trays Zestawy narzędzi do szuflad | 267 | Shock absorber nut sets Zestawy nasadek do amortyzatorów | 313 | | |
| Accessories for tool cabinets Akcesoria do szafek | 269 | Tire valve stem inserter Przeciągacze do zaworów gumowych | 313 | | |
| Tool boxes Skrzynki narzędziowe |  | 270-271 | Wheel balance pliers Szczypce do wyważania kół | 314 | |
| Lubrication system tools Narzędzia do obsługi układu smarowania |  | 272-277 | Deep thin wall impact sockets 1/2" Udarowe klucze nasadowe 1/2" do felg aluminiowych | 314 | |
| Oil filter wrenches & sets Klucze do filtra oleju i zestawy | 272 | Valve core torque tools Klucze dynamometryczne do zaworów gumowych i metalowych | 314 | | |
| Oil drain plug sockets Klucze do spustu oleju | 274 | Wheel wrenches Klucze do kół | 315 | | |
| Grease guns & accessories Smarownice ręczne i akcesoria | 275 | Tire levels Łyżki do opon | 315 | | |
| Oil cans Oliwiarki | 277 | Workshop tools Narzędzia warsztatowe |  | 315-323 | |
| Oil and fuel pumps Pompy do oleju oraz paliwa | 277 | Flexi shafts Wałki giętkie | 315 | | |
| Pullers Ściągacze |  | 278-290 | Inspection tools Narzędzia inspekcyjne | 316 | |
| Pullers Ściągacze | 278 | Magnetic pick up tools Chwytyki magnetyczne | 318 | | |
| Roller stud extractor sets Zestawy ściągaczy do szpilek | 283 | Magnetic trays Tacki magnetyczne | 318 | | |
| Upholstery removers Ściągacze do tapicerki | 290 | Tweezers Pęsety | 319 | | |
| Car window tools Narzędzia do szyb samochodowych |  | 290-291 | Workshop creepers Leżanki warsztatowe | 319 | |
| Air condition tools Narzędzia do klimatyzacji |  | 291 | LED workshop lightning Oświetlenie warsztatowe LED | 320 | |
| Fuel feel pipe pliers Szczypce motoryzacyjne |  | 292-296 | Voltage testers Próbniki napięcia | 322 | |
| Engine repair tools Narzędzia do obsługi silnika |  | 296-307 | Number & letter stamps Znaczniki cyfrowe i literowe | 322 | |
| Piston ring compressors Zaciskacze do pierścieni | 296 | Thread repair sets & accessories Zestawy do naprawy gwintów i akcesoria | 322 | | |
| Engine repair and diagnostic tools Narzędzia do diagnostyki i naprawy silników | 297 | Pumps Pompki | 323 | | |
| Spark plug sockets Klucze do świec | 306 | Funnels, oil drainer & drainer pans Lejki, miski i zlewarki do oleju |  | 324 | |
| Bottle & floor jacks Dźwigniki słupkowe i podnośniki |  | 325-326 | Work benches Stojaki lakiernicze |  | |
| | | | 326 | | |



Battery chargers & battery testers
Prostowniki i testery akumulatorów

327-329



Electric hoists
Elektryczne wciągarki linowe

330



Chain blocks
Wciągarki łańcuchowe

330



Hand pullers
Wciągarki linowe, ręczne

330



- GB Service tool cabinet with tools
- D Serviceschrank mit Werkzeugen
- PL Szafka serwisowa z narzędziami
- RUS Сервисный шкаф с инструментами
- CZ Servisní skříňka s nářadím
- H Szervizszekrény szerszámokkal
- RO Cutie de service cu scule
- E Armario para herramientas de servicio
- CN 工具车托盘组套



| | | | | |
|--|---|-------------------------------|---|---|
| 177 PCS 12 TRAY WKŁAD | 958x766 x465 mm | 6x | BALL BEARING ŁOŻYSKA KULKOWE | 28kg 35kg 35kg |
| DRAWERS LOCKING BLOKADA SZUFLAD | NON SLIP POLYPROPYLENE WORKTOP ANTIPOŚLIZGOWY POLIPROPYLENOWY BLAT | WHEELS TOŁKĄ | 2xT | |
| UNIVERSAL PERFORATION UNIWEERSALNA PERFORACJA | DOUBLE WALLS PODWÓJNE ŚCIANY | | | |

12 interchangeable trays with YATO tools
12 wymiennych modułów z narzędziami YATO

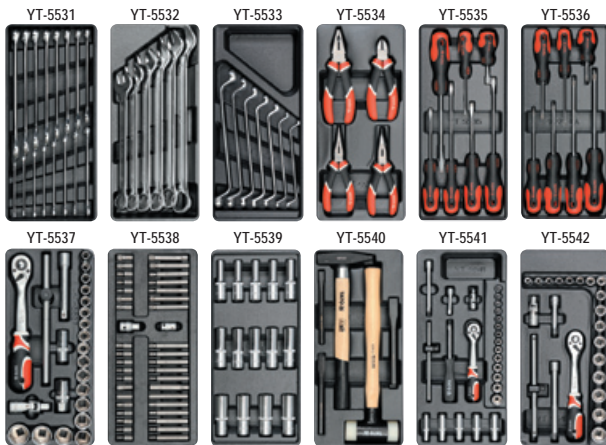

DRAWER / SZUFLADA 1

3/8" (9.5 mm): 6, 7, 8, 9, 10, 11, 12, 13, 14, 15, 16, 17, 18, 19, 20, 21, 22 mm; CrV 50BV30; 3/8" (9.5 mm); (76; 152.4 mm); CrV 50BV30; 3/8" (9.5 mm); CrV 50BV30; 3/8" (9.5 mm); (200 mm); 72T: CrV 6140; 3/8" (9.5 mm) x 198 mm; CrV 50BV30; 1/2" (12.7 mm): 10, 11, 12, 13, 14, 15, 16, 17, 18, 19, 20, 21, 22, 23, 24, 27, 30, 32 mm; CrV 50BV30; 1/2" (12.7 mm); (127 mm); CrV 50BV30; 1/2" (12.7 mm); CrV 50BV30; 1/2" (12.7 mm); (255 mm); 72T: CrV 6140; 1/2" (12.7 mm) x 255 mm; CrV 50BV30; 1/2" (12.7 mm); 16; 21 mm; CrV 50BV30; 1/4" (6.3 mm): 3.5, 4.0, 4.5, 5.0, 5.5, 6.0, 7.0, 8.0, 9.0, 10.0, 11.0, 12.0, 13.0, 14.0 mm; CrV 50BV30; 1/4" (6.3 mm); 8, 10, 11, 12, 13 mm; CrV 50BV30; 1/4" (6.3 mm); (50.8; 101.6 mm); CrV 6140; 1/4" (6.3 mm); CrV 50BV30; 1/4" (6.3 mm); (155 mm); 72T: CrV 6140; 1/4" (6.3 mm); (150 mm); CrV 50BV30; 1/4" (6.3 mm) x 152.4 mm; CrV 50BV30

DRAWER / SZUFLADA 2

3x75, 5x100, 5x150, 6x38, 6x100, 6x150, 8x150 mm; CrMo
PH0x100, PH1x75, PH1x100, PH2x38, PH2x100,
PH2x150, PH3x150 mm; CrMo 180mm; 160mm;
160 mm LONG NOSE; 160 mm BENT NOSE

DRAWER / SZUFLADA 3

22, 24, 27, 28, 30, 32 mm; CrV; 6, 7, 8, 9, 10, 11, 12, 13, 14, 15, 16, 17, 18, 19, 20, 21 mm; CrV; 1/2" (12.7 mm); 8, 9, 10, 11, 12, 13, 14, 15, 16, 17, 18, 19, 20, 21 mm (L=76 mm); CrV 50BV30

DRAWER / SZUFLADA 4

300 g (L=300 mm); 40 mm (L=350 mm); 10x8x142 mm, 12x10x152 mm, 16x13x172 mm; H4, H5, H6, H7, H8, H10, H12 (L=30 mm); H4, H5, H6, H7, H8, H10, H12 (L=75 mm); AISI S2; M5, M6, M7, M10, M12 (L=30 mm); M5, M6, M7, M10, M12 (L=75 mm); AISI S2; T20, T25, T30, T40, T45, T50, T55 (L=30 mm); T20, T25, T30, T40, T45, T50, T55 (L=75 mm); AISI S2; 1/2" (12.7 mm), 3/8" (9.5 mm); 6x7, 8x9, 10x11, 12x13, 14x15, 16x17, 18x19 mm; CrV

WHITE
CARTON BOX
& COLOR LABEL

| YATO | drawers / szuflady | |
|---------|--------------------|---|
| YT-5530 | 6 | 1 |

- GB Roller cabinet
- D Werkstattrollwagen
- PL Szafka serwisowa
- RUS Инструментальный кабинет
- CZ Dílenská skříňka
- H Görgös szerszámátároló
- RO Dulap de scule
- E Armario en ruedas
- CN 工具车

| | | | |
|---------------------------------|---|--|---|
| 995x680 x458mm | 4x | DRAWERS LOCKING BLOKADA SZUFLAD | CENTRAL LOCK CENTRALNY ZAMEK |
| 300 kg max. | BALL BEARING ŁOŻYSKA KULKOWE | WHEELS WITH BRAKE Ø 5" (127 mm) | NON SLIP POLYPROPYLENE WORKTOP ANTIPOŚLIZGOWY POLIPROPYLENOWY BLAT |
| | | 4xT | |

- GB Roller cabinet
- D Werkstattrollwagen
- PL Szafka serwisowa
- RUS Инструментальный кабинет
- CZ Dílenská skříňka
- H Görgös szerszámátároló
- RO Dulap de scule
- E Armario en ruedas
- CN 工具车

| | | | |
|---------------------------------|---|--|---|
| 995x680 x458mm | 6x | DRAWERS LOCKING BLOKADA SZUFLAD | CENTRAL LOCK CENTRALNY ZAMEK |
| 300 kg max. | BALL BEARING ŁOŻYSKA KULKOWE | WHEELS WITH BRAKE Ø 5" (127 mm) | NON SLIP POLYPROPYLENE WORKTOP ANTIPOŚLIZGOWY POLIPROPYLENOWY BLAT |
| | | 2xT | |



| YATO | drawers / szuflady | |
|---------|--------------------|---|
| YT-0912 | 4 | 1 |



| YATO | drawers / szuflady | |
|---------|--------------------|---|
| YT-0913 | 6 | 1 |

GB Roller cabinet
 D Werkstattrollwagen
 PL Szafka serwisowa
 RUS Инструментальный кабинет
 CZ Dilenská skříňka
 H Görgös szerszámtároló
 RO Dulap de scule
 E Armario en ruedas
 CN 工具车

995x680
x458mm

7x

DRAWERS LOCKING
BLOKADA SZUFLAD

CENTRAL LOCK
CENTRALNY ZAMEK

NON SLIP
POLYPROPYLENE WORKTOP
ANTYPOŚLIZGOWY POLIPROPYLENOWY BLAT

300 kg max.

BALL BEARING
ŁOŻYSKA KULKOWE

WHEELS WITH BRAKE
KOLKA Z HAMULCAMI

Ø 5" (127 mm)
← 1" (25.4 mm)

2x



WHITE
CARTON BOX
& COLOR LABEL

| YATO | drawers / szuflady | |
|---------|--------------------|---|
| YT-0914 | 7 | 1 |

GB Roller cabinet
 D Werkstattrollwagen
 PL Szafka serwisowa
 RUS Инструментальный кабинет
 CZ Dilenská skříňka
 H Görgös szerszámtároló
 RO Dulap de scule
 E Armario en ruedas
 CN 工具车

BALL BEARING
ŁOŻYSKA KULKOWE

25kg
35kg

UNIVERSAL PERFORATION
UNIWERSALNA PERFORACJA

WHEELS
KOLKA

DRAWERS LOCKING
BLOKADA SZUFLAD

NON SLIP
POLYPROPYLENE WORKTOP
ANTYPOŚLIZGOWY POLIPROPYLENOWY BLAT

DOUBLE WALLS
PODWÓJNE SCIANY

958x766
x465 mm



WHITE
CARTON BOX
& COLOR LABEL

| YATO | drawers / szuflady | |
|---------|--------------------|---|
| YT-0902 | 6 | 1 |
| YT-0903 | 7 | 1 |

GB Roller cabinet
 D Werkstattrollwagen
 PL Szafka serwisowa
 RUS Инструментальный кабинет
 CZ Dilenská skříňka
 H Görgös szerszámtároló
 RO Dulap de scule
 E Armario en ruedas
 CN 工具车

958x766
x465 mm

7x

DRAWERS LOCKING
BLOKADA SZUFLAD

OIL PROOF STEEL WORKTOP
OLEJODOPORNY STALOWY BLAT

UNIVERSAL PERFORATION
UNIWERSALNA PERFORACJA

BALL BEARING
ŁOŻYSKA KULKOWE

25kg
35kg

NON SLIP
POLYPROPYLENE WORKTOP
ANTYPOŚLIZGOWY POLIPROPYLENOWY BLAT

DOUBLE WALLS
PODWÓJNE SCIANY

WHEELS
KOLKA



WHITE
CARTON BOX
& COLOR LABEL

| YATO | drawers / szuflady | |
|---------|--------------------|---|
| YT-0904 | 7 | 1 |

GB Roller cabinet
 D Werkstattrollwagen
 PL Wózek serwisowy
 RUS Инструментальная тележка
 CZ Dilenská skříňka
 H Görgös szerszámtároló
 RO Dulap de scule
 E Carro de taller
 CN 工具车

958x766
x465 mm

1x

DRAWERS LOCKING
BLOKADA SZUFLAD

UNIVERSAL PERFORATION
UNIWERSALNA PERFORACJA

BALL BEARING
ŁOŻYSKA KULKOWE

25kg
35kg

NON SLIP
POLYPROPYLENE WORKTOP
ANTYPOŚLIZGOWY POLIPROPYLENOWY BLAT

DOUBLE WALLS
PODWÓJNE SCIANY

WHEELS
KOLKA



WHITE
CARTON BOX
& COLOR LABEL

| YATO | drawers / szuflady | |
|---------|--------------------|---|
| YT-0905 | 1 | 1 |

GB Drawer insert / Combination spanners
D Schubladeneinlage / Schrauben- und Ringschlüssel
PL Wkład do szuflady / Klucze płasko-oczkowe
RUS Вклад к выдвижному ящику / Плоско-закрытый накладной ключ
CZ Vložka do zásuvky / Klíče ploché-očkové
H Fiókbetét / Kombinált kulcsok
RO Adaos la sertar / Chei plane - inelare
E Accesorio de cajón / Llave española de muletilla
CN 两用扳手托盘组套

PLASTIC TRAY & COLOR LABEL



CrV



6
PCS

22, 24, 27, 28, 30, 32 mm; CrV



GB Drawer insert / Bi-hexagonal ring spanner
D Schubladeneinlage / Doppelringschlüssel
PL Wkład do szuflady / Klucze oczkowe odgięte
RUS Вклад к выдвижному ящику / Ключ накладной изогнутый
CZ Vložka do zásuvky / Klíče očkové ohnuté
H Fiókbetét / Hajlítottszerű csillagkulcs
RO Adaos la sertar / Chei inelaro-curbată
E Accesorio de cajón / Llave de estrella
CN 双头高颈梅花扳手托盘组套

PLASTIC TRAY & COLOR LABEL



CrV



4
PCS

21x23, 24x27, 25x28, 30x32 mm; CrV



16
PCS

6, 7, 8, 9, 10, 11, 12, 13, 14, 15, 16, 17, 18, 19, 20, 21 mm; CrV



7
PCS

6x7, 8x9, 10x11, 12x13, 14x15, 16x17, 18x19 mm; CrV



GB Drawer insert / Pliers
D Schubladeneinlage / Zangen
PL Wkład do szuflady / Szczypce
RUS Вклад к выдвижному ящику / Клещи
CZ Vložka do zásuvky / Kleště
H Fiókbetét / Fogók
RO Adaos la sertar / Clește
E Accesorio de cajón / Pinzas
CN 钳子托盘组套

PLASTIC TRAY & COLOR LABEL



4
PCS

CrV



- 180 mm;
- 160 mm;
- 160 mm LONG NOSE;
- 160 mm BENT NOSE



GB Drawer insert / Slotted screwdrivers
D Schubladeneinlage / Flachscharber
PL Wkład do szuflady / Wkrętaki płaskie
RUS Вклад к выдвижному ящику / Плоские отвертки
CZ Vložka do zásuvky / Šroubováky ploché
H Fiókbetét / Lapos csavarhűzők
RO Adaos la sertar / Șurubelnițe plane
E Accesorio de cajón / Desarmadores planos
CN 一字螺丝批托盘组套

PLASTIC TRAY & COLOR LABEL



7
PCS

CrMo

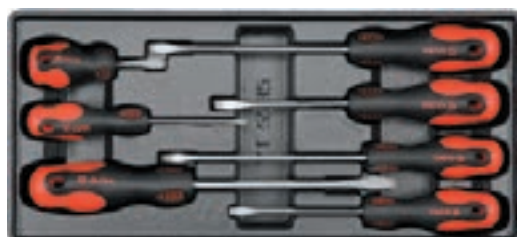

3x75, 5x100,
5x150, 6x38, 6x100, 6x150,
8x150 mm; CrMo



GB Drawer insert / Phillips screwdrivers
D Schubladeneinlage / Kreuzschlitzschrauber
PL Wkład do szuflady / Wkrętaki krzyżakowe
RUS Вклад к выдвижному ящику / Крестовидные отвертки
CZ Vložka do zásuvky / Šroubováky křížové
H Fiókbetét / Kereszt csavarhűzők
RO Adaos la sertar / Șurubelnițe în cruce
E Accesorio de cajón / Desarmadores de cruz
CN 十字螺丝批托盘组套

PLASTIC TRAY & COLOR LABEL



7
PCS

CrMo



PH0x100, PH1x75,
PH1x100, PH2x38, PH2x100,
PH2x150, PH3x150 mm; CrMo



GB Drawer insert / Socket set
D Schubladeneinlage / Steckschlüsselsatz
PL Wkład do szuflady / Zestaw kluczy nasadowych
RUS Вклад к выдвижному ящику / Торцовые ключи
CZ Vložka do zásuvky / Klíče nástrčné
H Fiókbetét / Dugókulcsok
RO Adaos la sertar / Duză cheie
E Accesorio de cajón / Llaves de cubo
CN 套筒托盘组套

PLASTIC TRAY & COLOR LABEL
22 PCS



3/8" (9.5 mm): 6, 7, 8, 9, 10, 11, 12, 13, 14, 15, 16, 17, 18, 19, 20, 21, 22 mm; CrV 50BV30;
 3/8" (9.5 mm): (76; 152.4 mm); CrV 50BV30;
 3/8" (9.5 mm); CrV 50BV30;
 3/8" (9.5 mm); (200 mm); 72T; CrV 6140;
 3/8" (9.5 mm) x 198 mm; CrV 50BV30

YATO
 YT-5542 8

GB Drawer insert / Socket set
D Schubladeneinlage / Steckschlüsselsatz
PL Wkład do szuflady / Zestaw kluczy nasadowych
RUS Вклад к выдвижному ящику / Торцовые ключи
CZ Vložka do zásuvky / Klíče nástrčné
H Fiókbetét / Dugókulcsok
RO Adaos la sertar / Duză cheie
E Accesorio de cajón / Llaves de cubo
CN 套筒托盘组套

PLASTIC TRAY & COLOR LABEL
25 PCS



1/4" (6.3 mm): 3.5, 4.0, 4.5, 5.0, 5.5, 6.0, 7.0, 8.0, 9.0, 10.0, 11.0, 12.0, 13.0, 14.0 mm; CrV 50BV30;
 1/4" (6.3 mm): 8, 10, 11, 12, 13 mm; CrV 50BV30;
 1/4" (6.3 mm): (50.8; 101.6 mm); CrV 6140;
 1/4" (6.3 mm); CrV 50BV30;
 1/4" (6.3 mm); (155 mm); 72T; CrV 6140;
 1/4" (6.3 mm); (150 mm); CrV 50BV30;
 1/4" (6.3 mm) x 152.4 mm; CrV 50BV30

YATO
 YT-5541 8

GB Drawer insert / Socket set
D Schubladeneinlage / Steckschlüsselsatz
PL Wkład do szuflady / Zestaw kluczy nasadowych
RUS Вклад к выдвижному ящику / Торцовые ключи
CZ Vložka do zásuvky / Klíče nástrčné
H Fiókbetét / Dugókulcsok
RO Adaos la sertar / Duză cheie
E Accesorio de cajón / Llaves de cubo
CN 套筒托盘组套

PLASTIC TRAY & COLOR LABEL
24 PCS



1/2" (12.7 mm): 10, 11, 12, 13, 14, 15, 16, 17, 18, 19, 20, 21, 22, 23, 24, 27, 30, 32 mm; CrV 50BV30;
 1/2" (12.7 mm); (127 mm); CrV 50BV30;
 1/2" (12.7 mm); CrV 50BV30;
 1/2" (12.7 mm); (255 mm); 72T; CrV 6140;
 1/2" (12.7 mm) x 255 mm; CrV 50BV30;
 1/2" (12.7 mm); 16; 21 mm; CrV 50BV30

YATO
 YT-5537 4

GB Drawer insert / Screwdriver bits
D Schubladeneinlage / Endstücke für Schraubenzieher
PL Wkład do szuflady / Końcówki śrubokrętowe
RUS Вклад к выдвижному ящику / Насадки для отвёрток
CZ Vložka do zásuvky / Šroubovací nástavce
H Fiókbetét / Csavarhúzó bitek
RO Adaos la sertar / Terminații pt. șurubelnițe
E Accesorio de cajón / Puntas para desarmadores
CN 旋具头托盘组套

PLASTIC TRAY & COLOR LABEL
40 PCS



H4, H5, H6, H7, H8, H10, H12 (L=30 mm); H4, H5, H6, H7, H8, H10, H12 (L=75 mm); AISI S2; M5, M6, M7, M10, M12 (L=30 mm); M5, M6, M7, M10, M12 (L=75 mm); AISI S2; T20, T25, T30, T40, T45, T50, T55 (L=30 mm); T20, T25, T30, T40, T45, T50, T55 (L=75 mm); AISI S2; 1/2" (12.7 mm), 3/8" (9.5 mm)

YATO
 YT-5538 8

GB Drawer insert / Deep sockets
D Schubladeneinlage / Tiefe Steckschlüssel
PL Wkład do szuflady / Klucze nasadowe długie
RUS Вклад к выдвижному ящику / Торцовые глубокие ключи
CZ Vložka do zásuvky / Klíče nástrčné hluboké
H Fiókbetét / Mély dugókulcsok
RO Adaos la sertar / Prize de curent adânci
E Accesorio de cajón / Llaves de cubo profundo
CN 六角长套筒托盘组套

PLASTIC TRAY & COLOR LABEL
14 PCS
CrV 50BV30



1/2" (12.7 mm): 8, 9, 10, 11, 12, 13, 14, 15, 16, 17, 18, 19, 20, 21 mm (L=76 mm); CrV 50BV30

YATO
 YT-5539 8

GB Drawer insert / Hammers and chisels
D Schubladeneinlage / Hämmer und Meißel
PL Wkład do szuflady / Młotki i przecinaki
RUS Вклад к выдвижному ящику / Молотки и зубила
CZ Vložka do zásuvky / Kladiva, dílata a sekáče
H Fiókbetét / Kalapácsok és hidegvágók
RO Adaos la sertar / Ciocane și dălți
E Accesorio de cajón / Martillos y cinceles
CN 锤头凿子托盘组套

PLASTIC TRAY & COLOR LABEL
5 PCS
CrV



300 g (L=300 mm);
 40 mm (L=350 mm);
 10x8x142 mm,
 12x10x152 mm, 16x13x172 mm

YATO
 YT-5540 8

GB Drawer insert
D Schubladeneinlage
PL Wkład do szuflady

RUS Вклад к выдвижному ящику
CZ Vložka do zásuvky
H Fiókbetét

RO Adaos la sertar
E Accesorio de cajón
CN 吸塑盒



for / dla:
YT-5531

for / dla:
YT-5532



for / dla:
YT-5533



| | |
|---|---|
| YATO  |  |
| YT-55311 | 5/30 |

| | |
|---|--|
| YATO  |  |
| YT-55321 | 5/30 |

| | |
|---|---|
| YATO  |  |
| YT-55331 | 5/30 |



for / dla:
YT-5534

for / dla:
YT-5535



for / dla:
YT-5536



| | |
|---|---|
| YATO  |  |
| YT-55341 | 5/30 |

| | |
|---|--|
| YATO  |  |
| YT-55351 | 5/30 |

| | |
|---|---|
| YATO  |  |
| YT-55361 | 5/30 |



for / dla:
YT-5537

for / dla:
YT-5538



for / dla:
YT-5539



| | |
|---|---|
| YATO  |  |
| YT-55371 | 5/30 |

| | |
|---|--|
| YATO  |  |
| YT-55381 | 5/30 |

| | |
|---|---|
| YATO  |  |
| YT-55391 | 5/30 |



for / dla:
YT-5540

for / dla:
YT-5541



for / dla:
YT-5542



| | |
|---|---|
| YATO  |  |
| YT-55401 | 5/30 |



| | |
|---|--|
| YATO  |  |
| YT-55411 | 5/30 |

| | |
|---|---|
| YATO  |  |
| YT-55421 | 5/30 |

GB Compartmented shelf
and paper roll holder
D Werkstattwagenab-
lage
mit Papierrollehalter
PL Półka z uchwytem
na papier
RUS Полка с держателем
для бумаги
CZ Police s úchytem na papír
H Kiegészítő polc és papírolni
tartó funkcióval
RO Compartiment pt. dulap
si suport hartie
E Estante con sujetapapel
CN 托架



for / dla: YT-0902, YT-0903, YT-0904, YT-0905

| | | |
|---|---------------------|---|
| YATO  | size / rozmiar (mm) |  |
| YT-0907 | 305x305x145 | 4 |

GB Dustbin
D Abfalleimer
PL Pojemnik na odpady
RUS Мусорный ящик
CZ Zásobník na odpad
H Szemetkosár
RO Lada de gunoi
E Cubo de basura
CN 废品箱





for / dla: YT-0902, YT-0903, YT-0904, YT-0905

| | | |
|---|---------------------|---|
| YATO  | size / rozmiar (mm) |  |
| YT-0908 | 300x300x190 | 4 |

GB Bottle holder
D Flaschenhalter
PL Pojemnik na butelki
RUS Контейнер для
бутылок
CZ Zásobník na nápoje
H Flakon tartó
RO Suport pt. sticle
E Soporte
para botellas
CN 瓶子挂壁





for / dla: YT-0902, YT-0903, YT-0904, YT-0905

| | | |
|---|---------------------|---|
| YATO  | size / rozmiar (mm) |  |
| YT-0909 | 250x110x80 | 6 |

GB Separate board for drawer
D Trennsteg für Werkstatt-
Wagen-Schublade
PL Przegroda do szafki
RUS Перегородки для ящика
CZ Půhrádka do police
H Több rekeszes tálcá
RO Sertar separat
de masura mica
E Separador
para armario
CN 抽屉分隔板



for / dla: YT-0902, YT-0903, YT-0904, YT-0905



| | | |
|---|---------------------|---|
| YATO  | size / rozmiar (mm) |  |
| YT-0910 | 391x58x4 | 24 |
| YT-0911 | 391x128x4 | 12 |

- GB Cantilever tool box
- D Werkzeugkoffer
- PL Skrzynka narzędziowa
- RUS Инструментальный ящик
- CZ Nástrojová skříňka
- H Szerszámoszláda
- RO Cutie pt. scule
- E Caja de herramientas
- CN 工具箱

WHITE
CARTON
BOX
& COLOR
LABEL





| YATO  | size / rozmiar (mm) |  |
|--|---------------------|--|
| YT-0882 | 360x150x115 | 4 |

| YATO  | size / rozmiar (mm) |  |
|--|---------------------|---|
| YT-0883 | 428x180x180 | 1 |



| YATO  | size / rozmiar (mm) |  |
|--|---------------------|---|
| YT-0884 | 460x200x180 | 1 |















| YATO  | size / rozmiar (mm) |  |
|--|---------------------|--|
| YT-0885 | 460x200x225 | 1 |

| YATO  | size / rozmiar (mm) |  |
|--|---------------------|---|
| YT-0886 | 510x220x240 | 1 |

- GB Tool box with tools
- D Werkzeugkoffer
- PL Skrzynka z narzędziami
- RUS Инструментальный ящик
- CZ Nástrojová skříňka
- H Szerszámoszláda
- RO Cutie pt. scule
- E Caja de herramientas
- CN 工具组套



| | | | | |
|------------------|-----------------------|--------------------|--------------------|----------------------|
| 62 PCS | 1/2" 12.5mm | CrV 6140 | CrV 6150 | CrV 50BV30 |
| 72T | AS-DRIVE | ⊖ | ⊕ | |



-  1/2" (12.7 mm): 10, 11, 12, 13, 14, 15, 16, 17, 18, 19, 20, 21, 22, 23, 24 mm (L=38 mm); 27, 30, 32 mm (L=42 mm); CrV 50BV30;
-  1/2" (12.7 mm); (76, 127, 254 mm); CrV 50BV30;
-  1/2" (12.7 mm); CrV 50BV30;
-  1/2" (12.7 mm): 21 mm; CrV 50BV30;
-  1/2" (12.7 mm); (255 mm); CrV 50BV30;
-  1/2" (12.7 mm); 72T; CrV 6140;
-  1/2" (12.7 mm); (450 mm); CrV 50BV30;
-  6, 7, 8, 9, 10, 11, 12, 13, 14, 15, 16, 17, 18, 19, 20, 21, 22, 24 mm; CrV;
-  6x100, 6x150, 8x200 mm; CrV 6150;
-  PH2x100, PH3x150, PH3x200 mm; CrV 6150;
-  180 mm; CrV;  160 mm; CrV;  160 mm; CrV;
-  1.5, 2, 2.5, 3, 4, 5, 6, 8, 10 mm; CrV 6150

WHITE
CARTON
BOX
& COLOR
LABEL



| YATO  | size / rozmiar (mm) |  |
|--|---------------------|---|
| YT-3895 | 475x230x365 | 1 |

GB Tool box with tools
D Werkzeugkoffer
PL Skrzynka z narzędziami
RUS Инструментальный ящик
CZ Nástrojová skříňka
H Szerszámoszláda
RO Cutie pt. scule
E Caja de herramientas
CN 工具组套



| | | | | |
|-----------|----------------|-------------|-------------|---------------|
| 64 PCS | 1/2" 12.5mm | CrV 6140 | CrV 6150 | CrV 50BV30 |
| CrMo | 72T | AS-DRIVE | ⊖ | ⊕ |

- 1/2" (12.7 mm): 10, 11, 12, 13, 14, 15, 16, 17, 18, 19, 20, 21, 22, 23, 24 mm (L=38 mm); 27, 30, 32 mm (L=42 mm); CrV 50BV30;
- 1/2" (12.7 mm); (76, 127, 254 mm); CrV 50BV30;
- 1/2" (12.7 mm); CrV 50BV30;
- 1/2" (12.7 mm); 21 mm; CrV 50BV30;
- 1/2" (12.7 mm); (255 mm); CrV 50BV30;
- 1/2" (12.7 mm); (255 mm); 72T; CrV 6140;
- 1/2" (12.7 mm); (457 mm); CrV 50BV30;
- 6, 7, 8, 9, 10, 11, 12, 13, 14, 15, 16, 17, 18, 19, 20, 21, 22, 24 mm; CrV;
- 5x100, 6x150, 8x200 mm; S2;
- PH1x100, PH2x150, PH3x200 mm; S2;
- 180 mm; CrV; 160 mm; CrV; 160 mm; CrV;
- 250 mm; CrV; 180 mm; CrMo;
- 1.5, 2, 2.5, 3, 4, 5, 6, 8, 10 mm; CrV 6150

WHITE
CARTON
BOX
& COLOR
LABEL

| | | |
|-------------|---------------------|---|
| YATO | size / rozmiar (mm) | 1 |
| YT-38950 | 495x200x290 | 1 |



GB Tool box with tools
D Werkzeugkoffer
PL Skrzynka z narzędziami

RUS Инструментальный ящик
CZ Nástrojová skříňka
H Szerszámoszláda

RO Cutie pt. scule
E Caja de herramientas
CN 工具组套

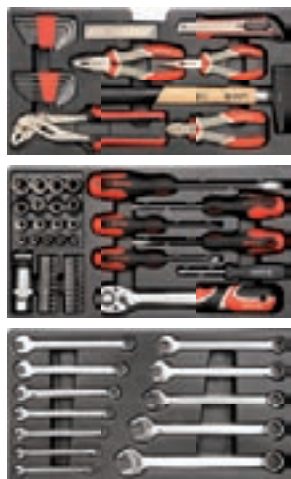

- 1/2" (12.7 mm): 10, 11, 12, 13, 14, 15, 17, 19 mm (L=38 mm); 1/4" (6.3 mm): 5, 6, 7, 8, 9, 10, 11, 12, 13 mm (L=25 mm); CrV 50BV30;
- 1/2" (12.7 mm); 21 mm; CrV 50BV30;
- 1/2" (12.7 mm); (255 mm); 72T; CrV 6140;
- 1/4" (6.3 mm); (150 mm); CrV 50BV30;
- 1/4" (6.3 mm) x 1/4" (6.3 mm); CrV 50BV30;
- 1/4" (6.3 mm): 3 (x2), 4 (x2), 5 (x2), 5.5 (x2), 6 (x2) mm (L=25 mm); AISI S2;
- 1/4" (6.3 mm): PH0, PH1 (x2), PH2 (x2), PH3 (L=25 mm); AISI S2;
- 1/4" (6.3 mm): PZ0, PZ1 (x2), PZ2 (L=25 mm); AISI S2;
- 6, 7, 8, 9, 10, 11, 12, 13, 14, 15, 17, 19 mm; CrV;
- 5x75 mm, 6x100 mm, 8x150 mm, PH1x75 mm, PH2x100 mm; S2;
- 180 mm; CrV; 160 mm; CrV; 160 mm; CrV;
- 250 mm; 300 g; 18 mm; SK2; 18x0.5 mm; SK2;
- 1.5, 2, 2.5, 3, 4, 5, 5.5, 6 mm; T10, T15, T20, T25, T27, T30, T40; CrV

| | | | | |
|-----------|----------------|---------------|-------------|---------------|
| 80 PCS | 1/2" 12.5mm | 1/4" 6.3mm | CrV 6140 | CrV 50BV30 |
| ⊖ | ⊕ | S2 | 72T | AS-DRIVE |



WHITE
CARTON
BOX
& COLOR
LABEL

| | | |
|-------------|---------------------|---|
| YATO | size / rozmiar (mm) | 1 |
| YT-38951 | 460x220x245 | 1 |

- GB Oil filter wrench
- D Ölfilterschlüssel
- PL Klucz do filtra oleju
- RUS Ключ к масляному фильтру
- CZ Klíč na olejový filtr
- H Olajsűrő kulcs
- RO Cheie pt. filtrul de ulei
- E Llave para el filtro de aceite
- CN 滤清器扳手

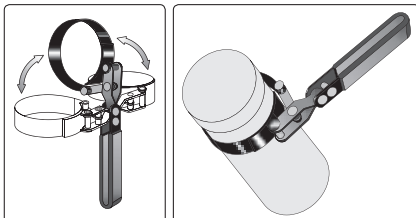

SLIDING CARD

| YATO | Ø (mm) | |
|---------|--------|-------|
| YT-0820 | 60-73 | 12/48 |
| YT-0821 | 73-85 | 12/48 |
| YT-0822 | 85-95 | 12/48 |
| YT-0823 | 95-111 | 12/48 |

- GB Belt oil wrench
- D Ölfilterschlüssel mit Riemen
- PL Klucz taśmowy do filtrów oleju
- RUS Ключ тросовый для масляных фильтров
- CZ Klíč na olejové filtry
- H Olajsűrő kulcs
- RO Cheie filtru cu banda
- E Llave de cinta para filtros de aceite
- CN 皮带钳扳手

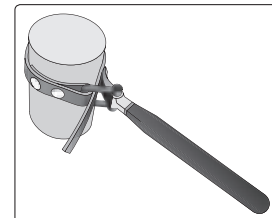

BLISTER CARD

| YATO | Ø (mm) | |
|---------|---------|------|
| YT-0824 | 80-160 | 6/60 |
| YT-0825 | 100-200 | 5/20 |

- GB Oil filter wrench
- D Ölfilterschlüssel
- PL Klucz do filtra oleju
- RUS Съёмник масляных фильтров
- CZ Klíč na filtr oleju řetězový
- H Olajsűrő kulcs, láncos
- RO Cheie filtru ulei cu lanț
- E Llave de filtro de cadenta
- CN 滤清器扳手



63-120 mm
2.5-4"

3/8" 10.0 mm
1/2" 12.5 mm

HRC 40-50

CrV



COLOR BOX

| YATO | |
|---------|-------|
| YT-0826 | 12/36 |

- GB Cap type oil filter wrench set
- D Steckschlüsselsatz für den Ölfilter
- PL Zestaw kluczy nasadowych do filtra oleju
- RUS Набор торцовых ключей к масляному фильтру
- CZ Sada miskovitých klíčů na olejové filtry
- H Dugókulcs készlet olajsűrőhöz
- RO Set de chei tubulare pt. filtru de ulei
- E Juego de llaves de tubo para el filtro de aceite
- CN 碗型滤清器扳手组套



15 PCS

FIBRE REINFORCED POLYMER

3/8" 10mm

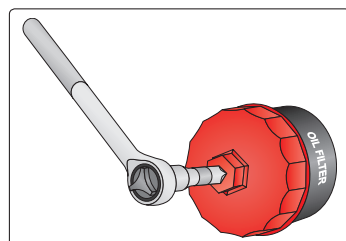

- 93/15F, 93/36F, 90/15F,
- 82/15F, 80/15F, 76/14F,
- 74/15F, 74/76/15F, 73/14F,
- 68/14F, 65/67/14F

BMC & COLOR SLEEVE



| YATO | Ø | |
|---------|---------------|---|
| YT-0595 | 3/8" (9.5 mm) | 5 |

GB Cap type oil filter wrench set
D Steckschlüsselsatz für den Ölfilter
PL Zestaw kluczy nasadowych do filtra oleju
RUS Набор торцовых ключей к масляному фильтру
CZ Sada miskovitých klíčů na olejové filtry

H Dugókulcs készlet olajsűrőhöz
RO Set de chei tubulare pt. filtru de ulei
E Juego de llaves de tubo para el filtro de aceite
CN 碗型滤清器扳手组套

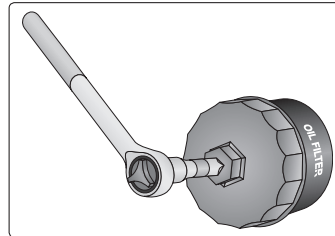

13 PCS
3/8" 10mm
1/2" 12.5mm
65-120 mm



BMC & COLOR SLEEVE



| YATO | number number | size rozmiar | layers warstwy | grooves bruzdy | faces powierzchnie | car models modele samochodu | |
|---------|---------------|--------------|----------------|----------------|--------------------|---|---|
| YT-0594 | 66/6 | SW66 | 1 | 6 | | Fiat Punto 1.2, Renault Clio 1.2, Rapid, Twingo | 5 |
| | 76/8 | SW76 | 1 | 8 | | Fiat, Lancia | |
| | 76/12 | SW76 | 1 | | 12 | Fiat, Mercedes, Renault | |
| | 86/16 | SW86 | 1 | | 16 | Volvo | |
| | 86/18 | SW86 | 1 | | 18 | VW Golf, Audi A6 TDI, Peugeot, Citroen | |
| | 92/10 | SW92 | 1 | | 10 | Fiat | |
| | 93/45 | SW93 | 1 | 45 | | VW, Audi TDI | |
| | 96/18 | SW96 | 1 | 18 | | Audi A4, A6 TDI, VQ Passat TDI, Renault Laguna | |
| | 106/15 | SW106 | 1 | | 15 | Fiat Ducato | |
| | 108/15 | SW108 | 1 | | 15 | Volvo | |
| | 108/18 | SW108 | 1 | 18 | | Renault Espace, Laguna, Safrane, Traffic | |

GB Cap type oil filter wrench set
D Steckschlüsselsatz für den Ölfilter
PL Zestaw kluczy nasadowych do filtra oleju
RUS Набор торцовых ключей к масляному фильтру
CZ Sada miskovitých klíčů na olejové filtry

H Dugókulcs készlet olajsűrőhöz
RO Set de chei tubulare pt. filtru de ulei
E Juego de llaves de tubo para el filtro de aceite
CN 碗型滤清器扳手组套

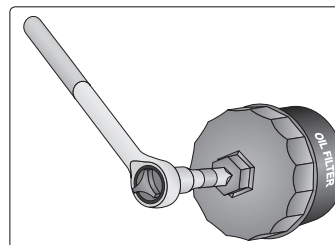

30 PCS
3/8" 10mm

BMC & COLOR SLEEVE



| YATO | number number | size rozmiar | layers warstwy | grooves bruzdy | faces powierzchnie | car models modele samochodu | |
|---------|---------------|--------------|----------------|----------------|--------------------|---|---|
| YT-0596 | 66/6 | SW66 | 1 | 6 | | Fiat Punto 1.2, Renault Clio 1.2, Rapid, Twingo | 3 |
| | 65/14 | SW65 | 1 | | 14 | Daihatsu, Toyota, Nissan, Fiat | |
| | 65/67 | SW65-67 | 1 | | 14 | Daihatsu, Toyota | |
| | 68/14 | SW68 | 1 | | 14 | Mazda, Ford, Subaru | |
| | 73/14 | SW73 | 1 | | 14 | Toyota, Lexus | |
| | 74/15 | SW74 | 1 | | 15 | Audi, Rover, Chrysler | |
| | 74/76 | SW74-76 | 2 | | 15 | Ford, Opel, VW, Audi, Mercedes | |
| | 75/77 | SW75-77 | 2 | | 15 | VW, Audi, Isuzu, Mercedes | |
| | 76/12 | SW76 | 1 | | 12 | Fiat, Mercedes, Renault | |
| | 76/14 | SW76 | 1 | | 14 | VW, Porsche, Mercedes, BMW, Audi, Opel | |
| | 76/30 | SW76 | 1 | 30 | | Ford | |
| | 76/8 | SW76 | 1 | 8 | | Fiat, Lancia | |
| | 78/15 | SW78 | 1 | | 15 | Nissan, Ford, Toyota | |
| | 80/15 | SW80 | 1 | | 15 | Nissan, Honda, Opel, Mazda | |
| | 80/82 | SW80-82 | 2 | | 15 | Subaru, Toyota, Honda, Nissan | |
| | 86/16 | SW86 | 1 | | 16 | Volvo | |
| | 86/18 | SW86 | 1 | | 18 | VW Golf, Audi A6 TDI, Peugeot, Citroen | |
| | 90/15 | SW90 | 1 | | 15 | Honda, Mitsubishi, Isuzu | |
| | 92/10 | SW92 | 1 | | 10 | Fiat | |
| | 93/15 | SW93 | 1 | | 15 | Mazda, Volvo, Mitsubishi, Nissan, Honda | |
| | 93/36 | SW93 | 1 | 36 | | Ford | |
| | 93/45 | SW93 | 1 | 45 | | VW, Audi TDI | |
| | 95/15 | SW95 | 1 | 15 | | Toyota, Alfa Romeo, Ford | |
| | 96/18 | SW96 | 1 | 18 | | Audi A4, A6 TDI, VQ Passat TDI, Renault Laguna | |
| | 100/15 | SW100 | 1 | | 15 | Isuzu, Mitsubishi | |
| | 106/15 | SW106 | 1 | | 15 | Fiat Ducato | |
| | 108/15 | SW108 | 1 | | 15 | Volvo | |
| | 108/18 | SW108 | 1 | 18 | | Renault Espace, Laguna, Safrane, Traffic | |

- GB Oil filter sockets
- D Aufsätze für die Ölfilter
- PL Zestaw nasadek do filtrów oleju
- RUS Набор насадок к масляным фильтрам
- CZ Sada nástavců na olejové filtry
- H Olajszűrő leszedő készlet
- RO Set de cartușe pt. filtre de ulei
- E Juego de tapones para los filtros de aceite
- CN 滤油器套筒组套



| | | |
|----------|------|--------------------|
| 4 PCS | 3/8" | 27 32 36 38 mm |
| | 10mm | |
| CrV | | AS-DRIVE |
| | | BMC & COLOR SLEEVE |

| | | |
|---------|---------------|----|
| YATO | ○ | ☐ |
| YT-0598 | 3/8" (9.5 mm) | 20 |

- GB Oil drain plug set
- D Öllassschrauben
- PL Komplet kluczy do korków oleju
- RUS Комплект ключей для сливной пробки
- CZ Klíče nástrčné na zátky olejových van motorů
- H Olajleeresztő kulcs készlet
- RO Set bituri pt. bujon ulei
- E Juego de llaves para tapones de aceite
- CN 排油塞旋具组套

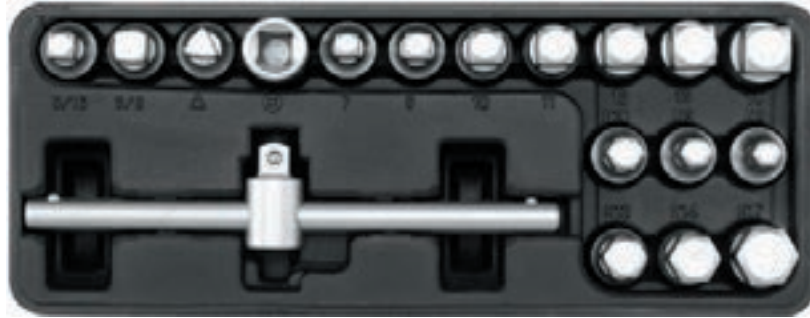

| | | |
|--------------------|------|--------------------------|
| 18 PCS | 3/8" | 7 8 10 11 12 13 14 mm |
| | 10mm | |
| CrV | | 8 9 10 12 14 17 mm |
| | | 5/16" 3/8" 10 mm |
| BMC & COLOR SLEEVE | | |

| | | |
|---------|---------------|----|
| YATO | ○ | ☐ |
| YT-0599 | 3/8" (9.5 mm) | 10 |

☐ 7, 8, 10, 11, 12, 13, 14 mm; ○ 8, 9, 10, 12, 14, 17 mm;
 ☐ 5/16" (8 mm), 3/8" (10 mm); △ 10 mm; 10 mm; 160 mm

- GB Oil drain plug set
- D Öllassschrauben Schlüsselsatz
- PL Komplet kluczy do korków oleju
- RUS Комплект ключей для сливной пробки
- CZ Klíče nástrčné na zátky olejových van motorů
- H Olajleeresztő kulcskészlet
- RO Set bituri pt. bujon ulei
- E Juego de llaves para tapones de aceite
- CN 排油塞旋具组套



| | | |
|-----------|------|----------------------------|
| 12 PCS | 3/8" | (mm) 8 11 13 |
| | 10mm | |
| CrV | | (mm) 8 9 10 12 14 17 |

| | |
|---------|-------|
| YATO | ☐ |
| YT-0600 | 10/20 |

SLIDING CARD

- GB Oil pan thread repair set
- D Reparatursatz für Verschlussstopfen von Ölwanen
- PL Zestaw naprawczy korków do miski olejowej
- RUS Набор для ремонта масляных пробок
- CZ Souprava na opravu vypouštěcích šroubů olejových van
- H Olajteknő-csavar javítókészlet
- RO Set pt. reparare dopuri baie de ulei
- E Juego de reparación para los tapones del cárter de aceite
- CN 螺纹修复组套



| | |
|-----------|------|
| 64 PCS | CrMo |
|-----------|------|

| | |
|---------|----|
| YATO | ☐ |
| YT-1757 | 10 |

M13 13 mm 10 pcs M17 17 mm 10 pcs
 M15 15 mm 10 pcs M20 20 mm 10 pcs

BMC & COLOR SLEEVE

GB Lever action grease gun with rigid spout
D Handhebel-Fettpresse
PL Smarownica ręczna z końcówką sztywną
RUS Шприц для масляной смазки с твердым наконечником и гибким шлангом

CZ Páková maznice s pevnou koncovkou
H Karos zsrízó
RO Masina de gresat cu furcun rigid
E Pistola de engrase
CN 手用黄油枪

COLOR BOX



P_{max.}
70 MPa

P
31 MPa

AI



500
cm³

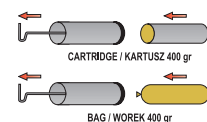

YATO

YT-0700

20



120
cm³

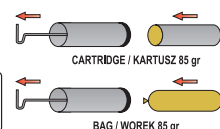

YATO

YT-0701

30



400
cm³

YATO

YT-0705

20

GB Grease gun
D Handhebel-Fettpresse
PL Smarownica ręczna
RUS Шприц для масляной смазки
CZ Páková maznice

H Karos zsrízó
RO Masina de gresat cu furcun rigid
E Pistola de engrase
CN 大容量黄油枪

COLOR BOX



P (MPa)
27-41

AI



600
cm³

YATO

YT-07042

6/12



800
cm³

YATO

YT-07043

4/8

GB Two-way operation grease gun
 D Handhebel-Fettpresse
 PL Smarownica ręczna, wzmocniona
 RUS Шприц для масляной смазки
 CZ Páková maznice

H Karos zsírzó
 RO Masina de gresat cu furtun rigid
 E Pistola de engrase
 CN 大容量黄油枪

COLOR BOX



500 cm³

P max. 70 MPa

AI

P 42 MPa

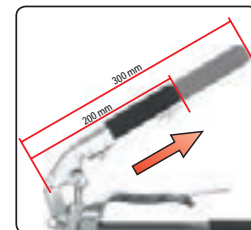
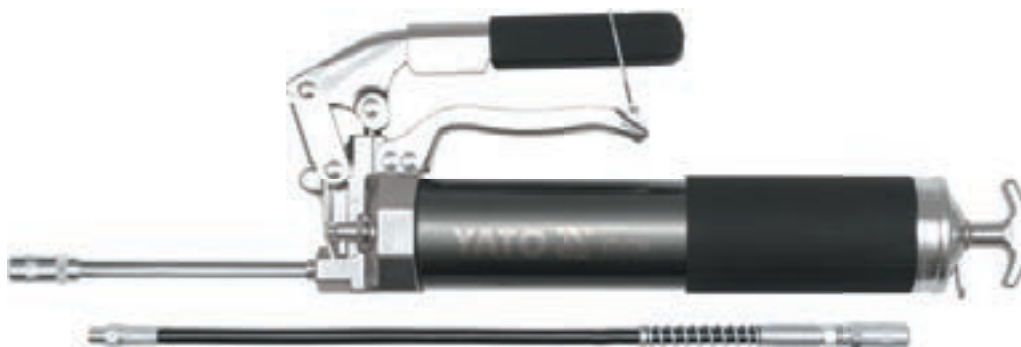

YATO 
 YT-0704 12

HIGH PRESSURE
69 MPa
 LOW VOLUME
14 g / 40 STROKE

WYSOKIE CIŚNIENIE
69 MPa
 NISKA WYDAJNOŚĆ
14 g / 40 CYKLI

LOW PRESSURE
6.9 MPa
 HIGH VOLUME
100 g / 40 STROKE

NISKIE CIŚNIENIE
6.9 MPa
 WYSOKA WYDAJNOŚĆ
100 g / 40 CYKLI

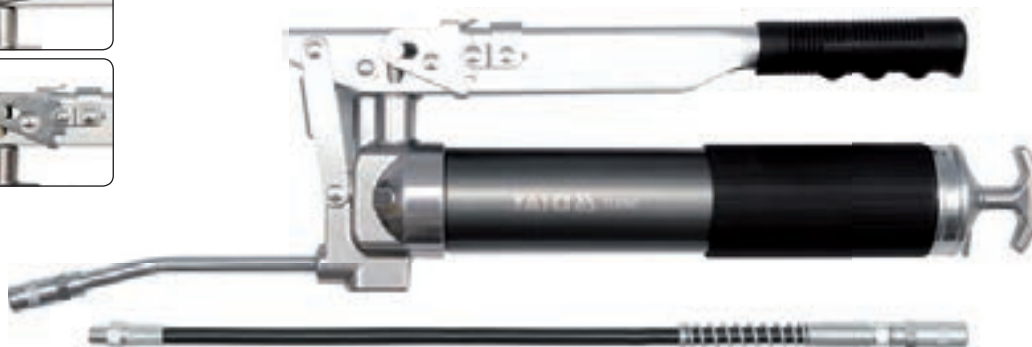

YATO 
 YT-07041 10

GB Oil transfer pump
 D Öl-Umfüllpumpe
 PL Pompa transferowa do oleju
 RUS Шприц для перекачки масел
 CZ Ruční olejová pumpa

H Olajpumpa
 RO Pompa de ulei de mana
 E Bomba manual de trasvase dual
 CN 输油泵

COLOR BOX



500 cm³

P max. 70 MPa

P 31 MPa



YATO 
 YT-0707 20

GB Oil drainer
 D Öl-Absaugpumpe
 PL Odsysarka ręczna do oleju
 RUS Ручной шприц для откачки масла
 CZ Ruční odsávačka oleje
 H Kézi olajszivattyú
 RO Pompa de ulei
 E Bomba manual de trasvase
 CN 输油泵

COLOR BOX



500 cm³

P max. 70 MPa

P 31 MPa





YATO 
 YT-0708 20

GB Flexible tube for grease gun
 D Schlauch für Fettpresse
 PL Wężyk do towotnicy
 RUS Шприц для перекачки масел
 CZ Hadička na maznice na šmir
 H Tömlő a zsírzóhoz
 RO Furtun flexibil pt. pistol de gresat
 E Manguera para engrasador
 CN 手用黄油枪软管



SLIDING CARD



| YATO  | L (mm) |  |
|--|--------|---|
| YT-0709 | 300 | 12/144 |
| YT-0710 | 500 | 12/144 |

GB Oiler with a flexible applicator
D Ölkanne mit elastischem Applikator
PL Oliwiarka z elastycznym aplikatorem
RUS Масленка с гибким аппликатором
CZ Olejnička s ohebným aplikátorem
H Hajlékony csövű olajozó
RO Gresor cu aplicator flexibil
E Aceitera con aplicador flexible
CN 油壶





| YATO  | cm ³ |  |
|--|-----------------|---|
| YT-0690 | 220 | 10/120 |
| YT-0691 | 270 | 10/120 |

GB Oiler with a flexible applicator
D Ölkanne mit elastischem Applikator
PL Oliwiarka z elastycznym aplikatorem
RUS Масленка с гибким аппликатором
CZ Olejnička s ohebným aplikátorem
H Hajlékony csövű olajozó
RO Gresor cu aplicator flexibil
E Aceitera con aplicador flexible
CN 油壶





IMPACT
RESISTANT
ODPORNE
NA UDERZENIA

| YATO  | cm ³ |  |
|--|-----------------|---|
| YT-06912 | 200 | 10/120 |

GB Oiler with a flexible applicator
D Ölkanne mit elastischem Applikator
PL Oliwiarka z elastycznym aplikatorem
RUS Масленка с гибким аппликатором
CZ Olejnička s ohebným aplikátorem
H Hajlékony csövű olajozó
RO Gresor cu aplicator flexibil
E Aceitera con aplicador flexible
CN 油壶





IMPACT
RESISTANT
ODPORNE
NA UDERZENIA

| YATO  | cm ³ |  |
|--|-----------------|---|
| YT-06913 | 300 | 10/120 |

GB Oiler with a flexible applicator
D Ölkanne mit elastischem Applikator
PL Oliwiarka z elastycznym aplikatorem
RUS Масленка с гибким аппликатором
CZ Olejnička s ohebným aplikátorem
H Hajlékony csövű olajozó
RO Gresor cu aplicator flexibil
E Aceitera con aplicador flexible
CN 油壶



IMPACT
RESISTANT
ODPORNE
NA UDERZENIA

| YATO  | cm ³ |  |
|--|-----------------|---|
| YT-06914 | 500 | 10/80 |

GB Oil pump
D Öl-Umfüllpumpe
PL Pompa tłokowa do oleju
RUS Шприц ручной заливной
CZ Ruční olejová pumpa
H Olajpumpa
RO Pompa de ulei de mana
E Bomba manual para aceite
CN 手摇泵



16-18
l/min

∇h
45-90
cm

55
min⁻¹
(max)

0.3 l
CYCLE
CYKL

FOR
OIL
DO
OLEJU

AI

COLOR BOX



| YATO  |  |
|--|---|
| YT-0712 | 10 |

GB High value rotary barrel pump
D Kurbelpumpe für Benzinfässer
PL Wysokowydajna pompa rotacyjna do paliwa
RUS Насос топливный ротационный
CZ Čerpadlo palivové rotační
H Kézi pumpa hordóhoz (forgatható)
RO Pompa rotativa pt. combustibil
E Bomba de combustible rotatoria
CN 手摇泵



FOR FUEL, DIESEL, OIL
DO PALIWI I OLEJU

1.0 l
CYCLE
CYKL

100
l/min

BRASS FILTER
180 µm
MOSIĘZNY FILTR

ARTISTATIC HOSE
2.4 m
HAZ ANTISTATYCZNY

∇h
100 cm

AI

WHITE
CARTON
BOX
& COLOR
LABEL



| YATO  |  |
|--|---|
| YT-0715 | 4 |

GB Two arms jaw puller
 D Abzieher-2-armig
 PL Ściągacz dwuramienny
 RUS Съёмник для подшипников
 CZ Stahovák
 H Csapaágyelhúzó
 RO Extractor rulmenti
 E Extractor
 CN 两爪拉马

COLOR BOX

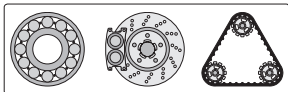

10 mm 4" 100mm



10 mm 3" 75mm



CrV

| YATO | size / rozmiar | max. Ø (mm) | max. force / max. sila nacisku (t) | |
|---------|----------------|-------------|------------------------------------|------|
| YT-2514 | 4" / 100 mm | 60 | 1.2 | 6/60 |

| YATO | size / rozmiar | max. Ø (mm) | max. force / max. sila nacisku (t) | |
|---------|----------------|-------------|------------------------------------|------|
| YT-2515 | 3" / 75 mm | 75 | 1.1 | 6/60 |

12 mm 4" 100mm



17 mm 6" 150mm



22 mm 8" 200mm



| YATO | size / rozmiar | max. Ø (mm) | max. force / max. sila nacisku (t) | |
|---------|----------------|-------------|------------------------------------|-------|
| YT-2516 | 4" / 100 mm | 100 | 1.4 | 12/48 |

| YATO | size / rozmiar | max. Ø (mm) | max. force / max. sila nacisku (t) | |
|---------|----------------|-------------|------------------------------------|-------|
| YT-2517 | 6" / 150 mm | 120 | 6 | 10/20 |

| YATO | size / rozmiar | max. Ø (mm) | max. force / max. sila nacisku (t) | |
|---------|----------------|-------------|------------------------------------|---|
| YT-2518 | 8" / 200 mm | 180 | 9 | 6 |

GB Three arms jaw puller
 D Abzieher-3-armig
 PL Ściągacz trójramienny
 RUS Съёмник для подшипников
 CZ Stahovák třiramenný
 H Csapaágyelhúzó
 RO Extractor rulmenti cu trei brate
 E Extractor detres patas
 CN 三爪拉马

COLOR BOX

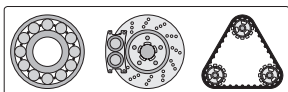

10 mm 3" 75mm



12 mm 4" 100mm



CrV

| YATO | size / rozmiar | max. Ø (mm) | max. force / max. sila nacisku (t) | |
|---------|----------------|-------------|------------------------------------|------|
| YT-2519 | 3" / 75 mm | 80 | 1.5 | 6/60 |

| YATO | size / rozmiar | max. Ø (mm) | max. force / max. sila nacisku (t) | |
|---------|----------------|-------------|------------------------------------|------|
| YT-2520 | 4" / 100 mm | 100 | 2.5 | 6/36 |

17 mm 6" 150mm



22 mm 8" 200mm



22 mm 12" 300mm



| YATO | size / rozmiar | max. Ø (mm) | max. force / max. sila nacisku (t) | |
|---------|----------------|-------------|------------------------------------|----|
| YT-2521 | 6" / 150 mm | 130 | 5 | 12 |

| YATO | size / rozmiar | max. Ø (mm) | max. force / max. sila nacisku (t) | |
|---------|----------------|-------------|------------------------------------|---|
| YT-2522 | 8" / 200 mm | 180 | 9 | 4 |

| YATO | size / rozmiar | max. Ø (mm) | max. force / max. sila nacisku (t) | |
|---------|----------------|-------------|------------------------------------|---|
| YT-2523 | 12" / 300 mm | 180 | 11 | 2 |

16

GB Three arms jaw puller
 D Abzieher-3-armig
 PL Ściągacz trójramienny
 RUS Съёмник для подшипников
 CZ Stahovák třiramenný
 H Csapaágyelhúzó
 RO Extractor rulmenti cu trei brate
 E Extractor detres patas
 CN 三爪拉马

COLOR BOX

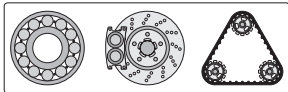

14 mm 3" 75mm

| YATO | size / rozmiar | Ø (mm) | |
|---------|----------------|--------|----|
| YT-2511 | 3" / 75 mm | 50-150 | 20 |

15 mm 4" 100mm

| YATO | size / rozmiar | Ø (mm) | |
|---------|----------------|--------|----|
| YT-2512 | 4" / 100 mm | 60-200 | 20 |

19 mm 6" 150mm

| YATO | size / rozmiar | Ø (mm) | |
|---------|----------------|--------|----|
| YT-2513 | 6" / 150 mm | 80-300 | 10 |

CrV

- GB Universal puller set
D Abziehvorrichtung für Lager
PL Ściągacz do łożysk w miejscach trudnodostępnych
RUS Съёмник подшипников в труднодоступных местах
CZ Sada na stahování ložisek na obtížně dostupných místech
H Csapágyelhúzó nehezen hozzáférhető helyekhez
RO Trăgător pt. rulmenți în locuri greu accesibile
E Extractor de rodamientos en lugares de difícil acceso
CN 多功能拉拔器

3 x 250 mm;

3 x 200 mm;

3 x 100 mm;

160 mm;

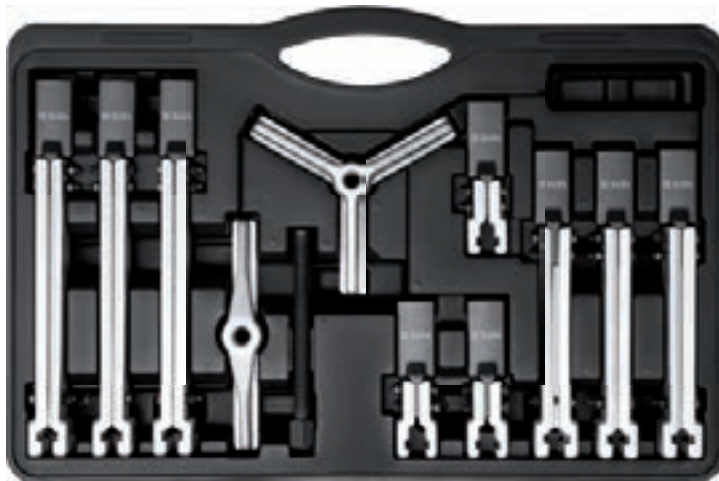
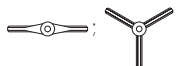

12
PCS

DROP
FORGED
KUTE

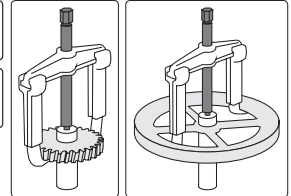

BMC
& COLOR
SLEEVE



YATO

YT-25105

2

- GB Pilot bearing puller
D Abzieher für Innenlager
PL Ściągacz do łożysk wnitřní
RUS Съёмник внутренних подшипников
CZ Stahovák na ložiska vnitřní
H Csapágyelhúzó, belső
RO Clește interior pt. extras rulmenți
E Extractor de cojinetes inter.
CN 轴承拉马

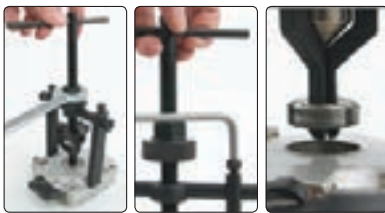

12-38
mm

CrV
6150



COLOR BOX



| YATO | ∅ (mm) | |
|---------|--------|----|
| YT-2510 | 12-38 | 20 |

- GB Universal wheel hub puller
D Scheiben- und Trommelbremsen Abzieher
PL Ściągacz uniwersalny do tarcz i bębnow
RUS Универсальный съёмник ступицы и полуоси
CZ Stahovák na brzdové bubny
H Univerzális féktárcsa és fékdob lehúzó
RO Trusa universala pt. transmisie cardanica
E Extractor universal de discos y tambores
CN 万用轮毂拉马

CrV

90-140 mm

130-180 mm

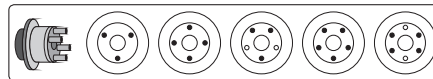

METAL CASE
& COLOR BOX



| YATO | L (mm) | |
|---------|--------|---|
| YT-0602 | 200 | 6 |

- GB Separator and hydraulic cylinder turnbuckle
D Separator und Abziehvorrichtung mit Hydraulikservomotor
PL Separator i ściągacz z silownikiem hydraulicznym
RUS Сепаратор и съёмник с сервомотором
CZ Oddělovač a stahovák s hydraulickým válcem
H Csapágyelhúzó és körmös csapágyelhúzó hidraulikus kézpumpával
RO Separator și ancoră cu servomotor hidraulic
E Separador y tensor de tornillo con cilindro hidráulico
CN 液压分离器组合

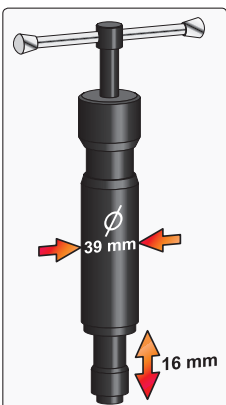

75-105 mm

50
kN

HRC
38-45

CrV

DROP
FORGED
KUTE

HYDRAULIC
CYLINDER
SIŁOWNIK
HYDRAULICZNY

METAL CASE
& COLOR BOX



| YATO | F (kN) | |
|---------|--------|---|
| YT-0609 | 50 | 2 |

- GB Twin leg puller with jaw hook
- D Doppel Abzieher mit Haken
- PL Ściągacz uniwersalny dwuramienny
- RUS Съемник универсальный
- CZ Stahovák dvouramenný univerzální
- H Csapágyelhúzó készlet
- RO Carlig cu falci pt. extras cu picor dublu
- E Extractor de cuatro patas
- CN 单边两爪拉马

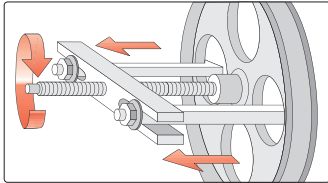
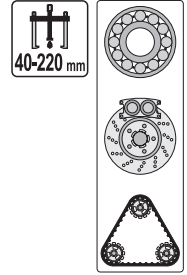

| | |
|-------------|----|
| YATO | |
| YT-0640 | 10 |

- GB Gear puller set
- D Lagerabzieher, Trennmesser
- PL Ściągacz dwuramienny i separator
- RUS Съемник универсальный с сепаратором
- CZ Stahovák dvouramenný
- H Csapágyelhúzó készlet
- RO Set angrenaj pt. extras
- E Kit de extractor
- CN 齿轮拉拔器

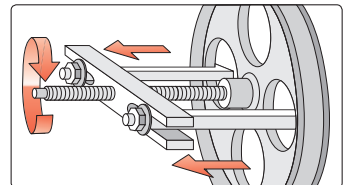
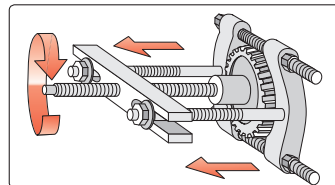
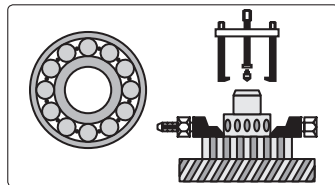
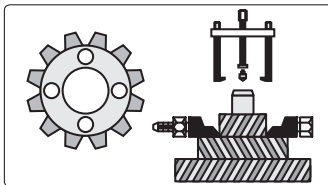
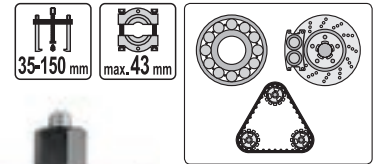

| | |
|-------------|---|
| YATO | |
| YT-0641 | 4 |

- GB Steering wheel remover / lock plate compressor set
- D Abziehvorrichtung für das Lenkrad
- PL Ściągacz koła kierownicy / sprężarki
- RUS Съемник рулевого колеса
- CZ Přípravek na stahování volantu
- H Kormánykerék-lehúzó
- RO Volar puller
- E Desmontador para el volante
- CN 方向盘拆装器



- 5/16" x 101 mm, 18 TPI;
- M8 x 89 mm;
- 3/8" x 89 mm, 16 TPI;
- 5/16" x 89 mm, 24 TPI;
- M14 x 1.5 mm;
- 9/16", 18 TPI;

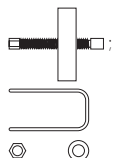

14
PCS



| | |
|-------------|----|
| YATO | |
| YT-2545 | 10 |

- GB Slide hammer gear / bearing puller set
D Träge Abziehvorrichtung für Lager
PL Ściągacz bezwładnościowy do łożysk
RUS Инерционный съемник подшипников
CZ Rázový stahovák s kluzným kladivem na ložiska

- H Csúszósúlyos csapágyelhúzó készlet
RO Set ciocan culisant extractor de rulmenti
E Extractor de inercia para cojinetes
CN 滑锤轴承拉拔器组套

5
PCS

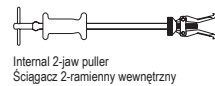
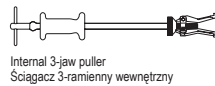
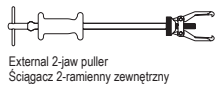
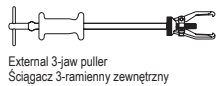
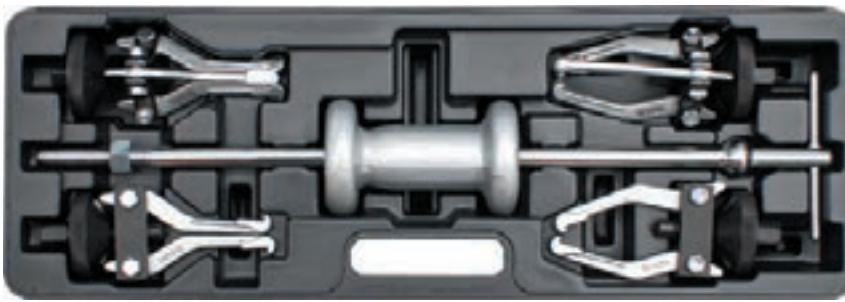
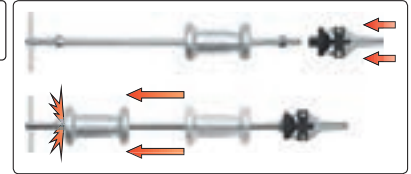

| | |
|-------------|---|
| YATO | |
| YT-2540 | 2 |

- GB Slide hammer set
D Träge Abziehvorrichtung für Naben und Lager
PL Ściągacz bezwładnościowy do piast i łożysk
RUS Инерционный съемник ступиц и подшипников
CZ Rázový stahovák s kluzným kladivem na náboje a ložiska

- H Csúszósúlyos kerékagy- és csapágyelhúzó készlet
RO Set ciocan culisant extractor de rulmenti și bușce
E Extractor de inercia para cubos y cojinetes
CN 滑锤轴承拉拔器组套

13
PCS

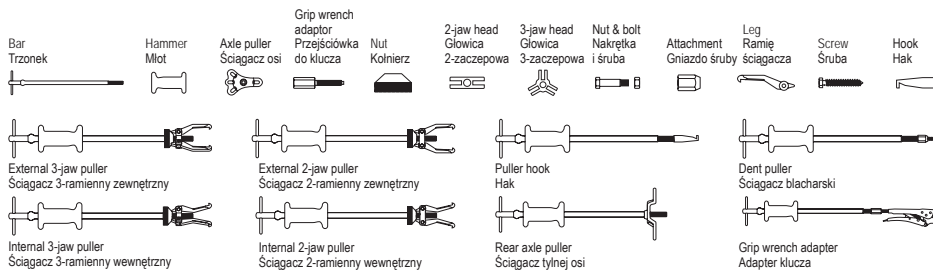
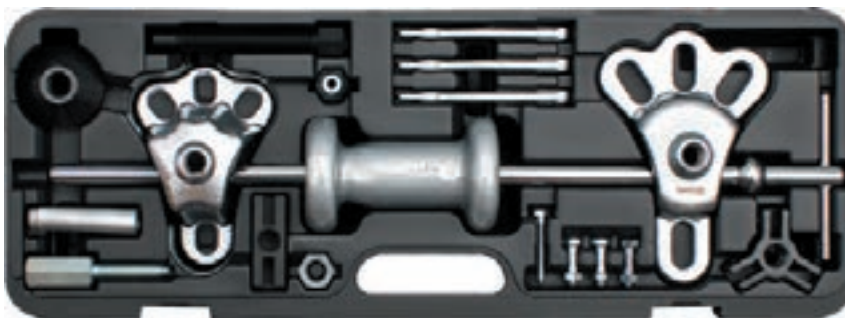
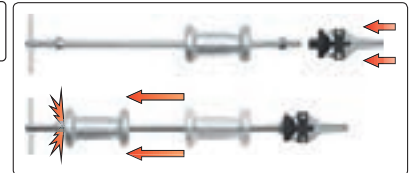

| | |
|-------------|---|
| YATO | |
| YT-2539 | 2 |

- GB Front wheel bearing adapter set
D Radlagerabzieher werkzeugsatz vorderachse
PL Ściągacz łożysk piasty przedniej
RUS Набор для снятия переднего подшипника переднеприводных автомобилей
CZ Sada na demontáž ložisek přední nápravy
H Csapágyelhúzó adapter készlet első futóműhöz
RO Set schimbat rulment roata fata
E Extractor de cojinetes para cubos de rueda delanteros
CN 轴承拆装组套

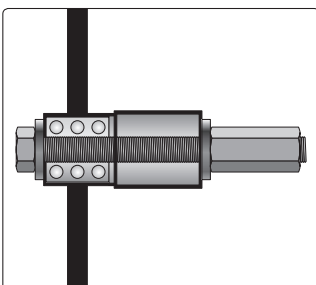
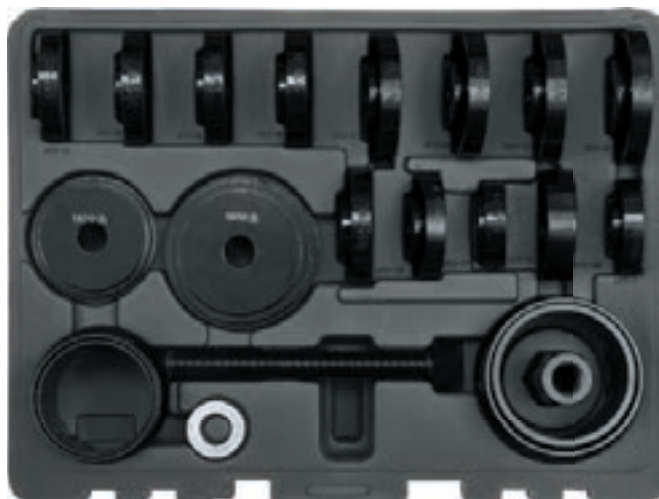

23
PCS

FOR FRONT WHEEL BEARING DO ŁOŻYSK PIASTY PRZEDNIEJ

16



| | |
|-------------|---|
| YATO | |
| YT-2541 | 2 |

GB Small mouth pull clamp
 D Selbstklemmende Blechschele
 PL Klamra blacharska samozaciskowa
 RUS Скрепса самозажимная для жестяных работ
 CZ Karosářská svěrka samosvorná k tahání

H Önszorító húzóató pofa, egyenes
 RO Clemă pt. tablă cu strângere automată
 E Grapa de hojalatería autoprensora
 CN 窄型张引夹

5t **125 mm** **42x20mm JAWS SZCZĘKI** **AUTO-TIGHTEN SAMC-ZACISKOWA**

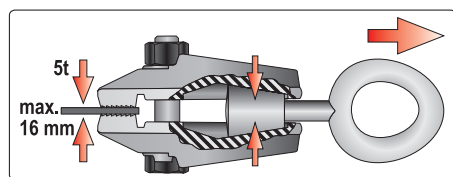

| | | |
|-------------|--------|----|
| YATO | L (mm) | |
| YT-2542 | 125 | 12 |

GB Box clamp
 D Selbstklemmende Blechschele vom Typ „C“
 PL Klamra blacharska samozaciskowa typu „C“
 RUS Скрепса самозажимная для жестяных работ типа „C“
 CZ Karosářská svěrka samosvorná k tahání typ „C“
 H Önszorító húzóató pofa, öblös
 RO Clemă pt. tablă cu strângere automată de tip „C“
 E Grapa de hojalatería autoprensora tipo „C“
 CN 宽型张引夹

3t **142 mm** **35x15mm JAWS SZCZĘKI** **TYPE C** **AUTO-TIGHTEN SAMC-ZACISKOWA**

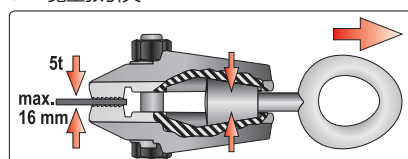

| | | |
|-------------|--------|----|
| YATO | L (mm) | |
| YT-2543 | 142 | 10 |

GB Twist socket set
 D Schraubendrehersatz
 PL Zestaw wykręteków do śrub
 RUS Набор отверток
 CZ Sada vyťahováku stržených šroubů

H Kicsavaró készlet csavarokhoz
 RO Set de chei pt. șuruburi
 E Juego de destornilladores
 CN 螺栓取出器组套

10 PCS
3/8"
10mm
CrMo
HRC 52-55

GB Screw extractor set & HSS drill bits
 D Schraubenausdrehersatz & HSS Bohrer
 PL Wykrętki do zerwanych śrub i wiertła do metalu HSS
 RUS Экстракторы и свёрла по металлу HSS
 CZ Vrtáky do přetržených šroubu & vrtáky na kov HSS
 H Törtcsavar kihajtó & főrészár fémhez HSS
 RO Capete pt. deșurubat șuruburi rupte & burghie pt. metal HSS
 E Destornillador para tornillos arrancados & HSS brocas
 CN 断丝取出器组套

12 PCS **HSS**
M3-M24

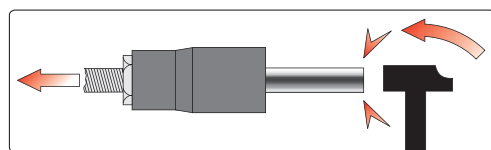

| YATO | Ø (mm) | M | Ø [mm] | |
|-------------|----------|-------|--------|----|
| YT-0591 | 1.4-3.6 | 3-6 | 1.8 | 40 |
| | 2.1-4.9 | 6-8 | 2.6 | |
| | 3.1-6.5 | 8-11 | 3.7 | |
| | 4.8-8.8 | 11-14 | 5.5 | |
| | 6.2-11.0 | 14-18 | 7.0 | |
| | 9.4-15.0 | 18-24 | 10.3 | |

16

| | |
|-------------|------|
| YATO | |
| YT-0603 | 8/32 |

GB Screw extractor set
 D Schraubenausdrehersatz
 PL Wykrętki do zerwanych śrub
 RUS Набор для извлечения обломанных болтов
 CZ Vrtáky do přetržených šroubu
 H Törtcsavar kihajtó
 RO Capete pt. deșurubat șuruburi rupte
 E Destornillador para tornillos arrancados
 CN 断丝取出器组套



6 PCS

PLASTIC BOX & SLIDING CARD

| YATO | Ø (mm) | L (mm) | |
|-------------|--------|--------|-------|
| YT-0590 | 3-6 | 52 | 12/48 |
| | 6-8 | 58 | |
| | 8-11 | 66 | |
| | 11-14 | 75 | |
| | 14-18 | 80 | |
| | 18-25 | 88 | |

- GB Bolt extractor set
D Satz von Ausziehvorrichtungen für Stifte
PL Zestaw wykręteków do szpilek
RUS Набор экстракторов для шпилек
CZ Souprava na demontáž závrtných šroubů

- H Csavarkihajtó készlet
RO Set de șurubelnțe pt. tije
E Juego de extractores de alfileres
CN 断丝取出器组套

BMC & COLOR SLEEVE



STEEL
8660
HRC
49-52

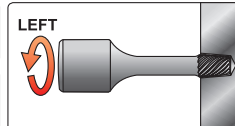

6
PCS

3/8"
10mm



5
PCS

1/2"
12.5mm

| YATO | Ø (mm) | |
|---------|-------------------|----|
| YT-0623 | 2; 3; 4; 6; 8; 10 | 50 |

| YATO | Ø (mm) | |
|---------|-------------------|----|
| YT-0624 | 8; 10; 12; 14; 16 | 20 |

- GB Heavy duty nut splitter
D Meißelsatz für Schraubenmutter
PL Zestaw przecinaków do nakrętek
RUS Набор зубил для гаек
CZ Souprava sekáčů na matice
H Csavaranya-vágó
RO Set retezatoare capace
E Juego de tajaderas para tuercas
CN 螺母破拆组套



BMC & COLOR SLEEVE



4
PCS
CrV
HRC
40-45

5/16" - 1/2" (9 - 12 mm);
1/2" - 5/8" (12 - 16 mm);
5/8" - 7/8" (16 - 22 mm);
7/8" - 1-1/16" (22 - 27 mm)

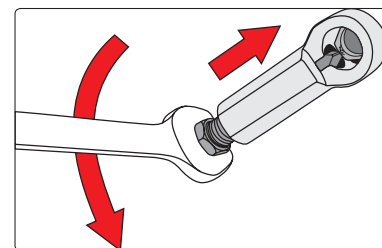

| YATO | |
|---------|----|
| YT-0585 | 10 |

- GB Roller stud extractor set
D Stéhbolzenlösersatz
PL Komplet wykręteków do szpilek
RUS Набор ключей для снятия штифтов
CZ Sada stahovadel na špendlíky
H Komplet tükhúzó
RO Set de dispozitive pt. demontaj șuruburi rupte
E Juego de extractores de agujas
CN 断丝取出器组套



4
PCS
CrV
50BV30

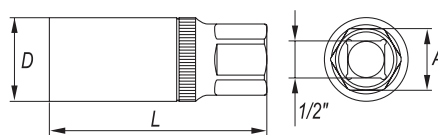
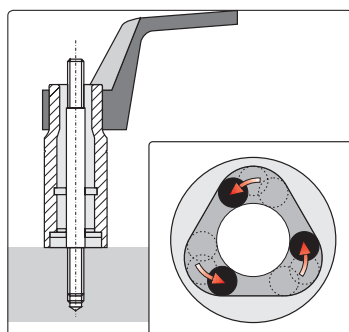

BMC & COLOR SLEEVE



| YATO | ● (mm) | D (mm) | L (mm) | A (mm) | |
|---------|--------|--------|--------|--------|------|
| YT-0620 | 6 | 24 | 60 | 21 | 6/24 |
| | 8 | | | | |
| | 10 | 28 | 70 | | |
| | 12 | | | | |

GB Tie rod end lifter
 D Universal-Kugelgelenk-Abzieher
 PL Ściągacz do sworzni kulistych
 RUS Съёмник шаровых опор
 CZ Stahovák kulových čepů řízení

H Gömbfej kinyomó
 RO Extractor pt. articulatii sferice
 E Extractor de pernos esféricos
 CN 球头拉拔器

135 mm



COLOR BOX



| YATO | (mm) | L (mm) | Ø (mm) | |
|---------|------|--------|--------|------|
| YT-0612 | 19 | 135 | 17.5 | 9/18 |

GB Tie rod end lifter
 D Universal-Kugelgelenk-Abzieher
 PL Ściągacz do sworzni kulistych
 RUS Съёмник шаровых опор
 CZ Stahovák kulových čepů řízení

H Gömbfej kinyomó
 RO Extractor pt. articulatii sferice
 E Extractor de pernos esféricos
 CN 球头拉拔器

265 mm

275 mm



COLOR BOX



| YATO | (mm) | L (mm) | Ø (mm) | |
|---------|------|--------|--------|----|
| YT-0613 | 16 | 265 | 17 | 20 |
| YT-0614 | 16 | 275 | 20 | 20 |

GB Rod end remover
 D Lenkstangeabzieher
 PL Ściągacz do drążków kierowniczych
 RUS Съёмник рулевых тяг
 CZ Přípravek na demontáž kulových čepů řízení

H Gömbfej kiütő
 RO Tija pt. indepartat
 E Extractor de barras de acoplamiento
 CN 拉拔器



200 mm

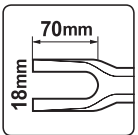

COLOR BOX



| YATO | L (mm) | |
|---------|--------|-------|
| YT-0615 | 200 | 18/36 |

GB Tie rod / ball joint tool kit
 D Werkzeugsatz für Bremssattel
 PL Ściągacze do drążków
 RUS Съёмник штанг
 CZ Stahováky táhel řízení
 H Rúdlehúzó
 RO Ancore pt. tije
 E Tensores para palancas
 CN 球头拉拔器组套

for / dla: YT-0990

5 PCS



BMC & COLOR BOX



| YATO | A (mm) | B (mm) | C (mm) | D (mm) | |
|---------|--------|--------|--------|--------|-------|
| YT-0616 | I | 18.2 | 65.0 | 24.0 | 123.9 |
| | II | 25.2 | 67.8 | | |
| | III | 30.2 | 56.3 | | |

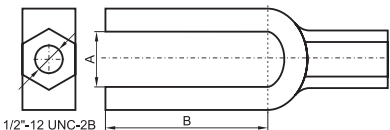
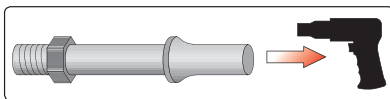
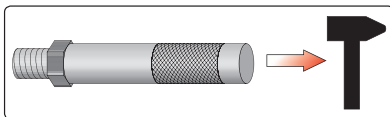

GB Seal puller
 D Dichtungs-Abziehwerkzeug
 PL Ściągacz do uszczelek
 RUS Съёмник прокладок
 CZ Škrabka na těsnění
 H Tömítéslehúzó
 RO Ancoră pt. garnituri
 E Tensor para juntas
 CN 密封圈拉拔器

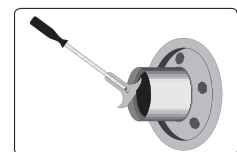

max. Ø 85 mm

SLIDING CARD



| YATO | L (mm) | |
|---------|--------|-------|
| YT-0642 | 200 | 12/48 |

GB Bearing race and seal driver set
D Presssatz für sicherungsringe, lager, etc.
PL Zestaw do osadzania łożysk i uszczelniaczy
RUS Втулка и набор сальниковых уплотнителей для автомобиля
CZ Sada na montáž gufer
H Csapágy, szimering, persely ki- és beütő készlet
RO Set pt. inlocuit rulment, simering
E Jugeo de conductores del anillo y del sello de rodadura
CN 斜型培令套安装器

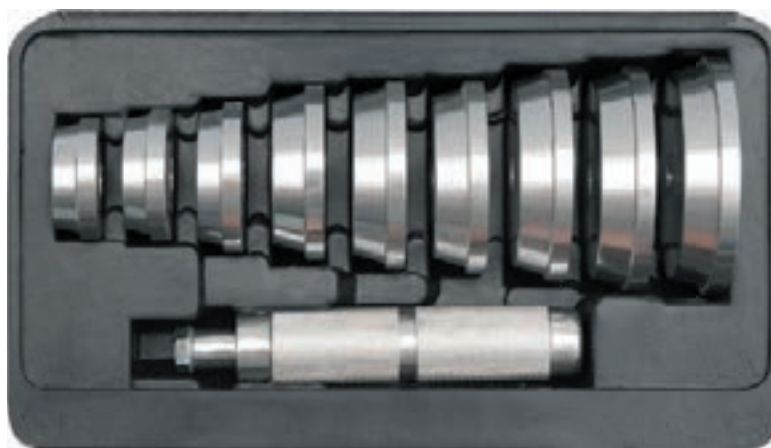

10
PCS

AI

BMC
& COLOR
SLEEVE

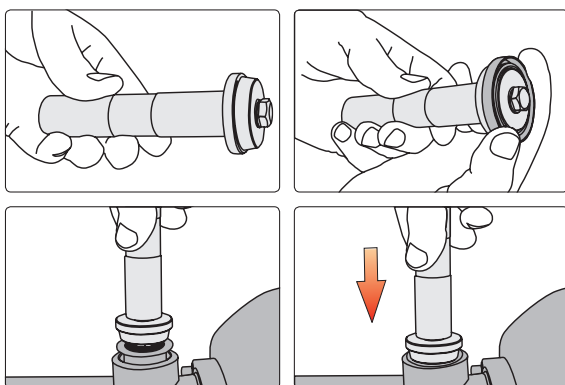

| YATO | No. | Ø (mm) | |
|---------|-----|--------|------|
| YT-0638 | 01 | 40 | 5/10 |
| | 02 | 44 | |
| | 03 | 50 | |
| | 04 | 59 | |
| | 05 | 63 | |
| | 06 | 65 | |
| | 07 | 72 | |
| | 08 | 76 | |
| | 09 | 81 | |

GB Car radio removal tool set
D Autoradio Demontage Werkzeugsatz
PL Zestaw do demontażu radioodbiorników samochodowych
RUS Набор для разборки авто-ресиверов
CZ Sada k demontáži autorádii
H Autorádió kiserelő készlet
RO Trusa de scule pt. indepartat radio
E Jugeo para el desmontaje de autorradio
CN 收音机拆卸组套

SLIDING
CARD



36
PCS

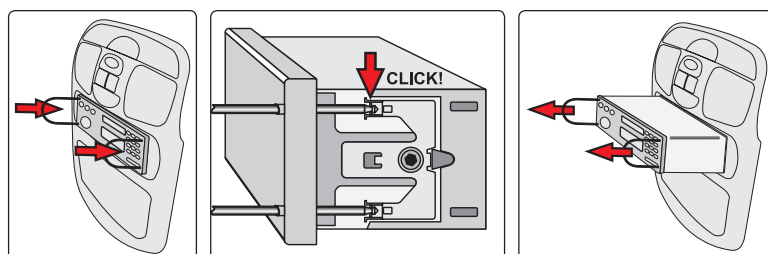
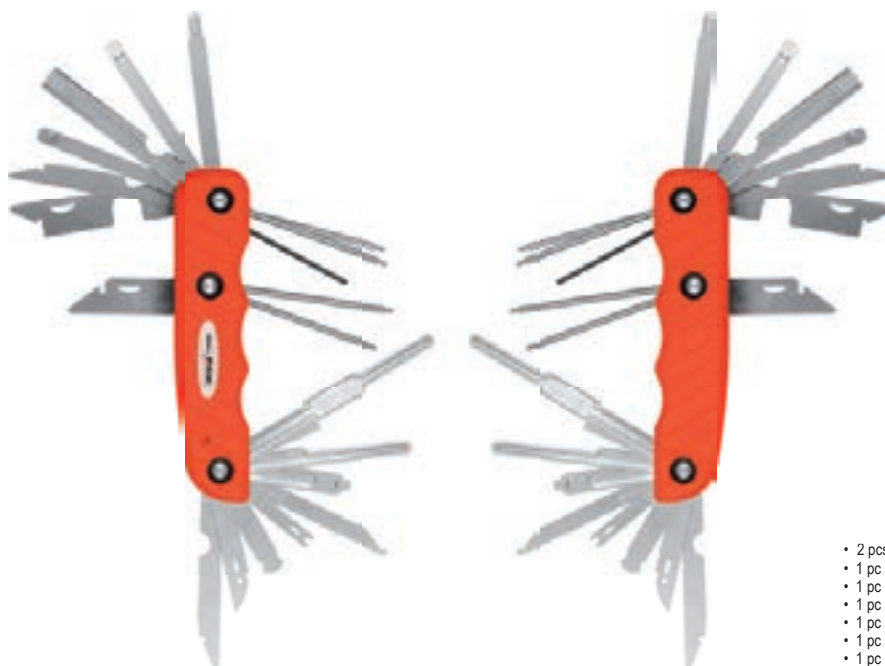

- 2 pcs P-01 Mercedes Benz, VW, Audi, Becker
- 1 pc P-02 Mercedes Benz, Porsche, Becker
- 1 pc P-03 VW
- 1 pc P-04 Skoda
- 1 pc P-05 Becker
- 1 pc P-07 Clarion
- 1 pc P-08 Kenwood
- 1 pc P-09 Sony
- 1 pc P-10 Kenwood
- 1 pc P-11-1 - Fiat Bravo, Fiat Brava
- 1 pc P-11-2 - Fiat Bravo, Fiat Brava
- 1 pc P-12 - Pioneer, JVC
- 1 pc P-13 - Panasonic
- 1 pc P-14 - Panasonic
- 1 pc P-15 - Sony
- 1 pc BMW
- 1 pc BMW, Opel
- 2 pcs Opel, Grundig, Blaupunkt
- 2 pcs VW, Audi, Ford

| YATO | |
|----------|-------|
| YT-08380 | 12/24 |

GB Car radio removal tool set
D Autoradio Demontage Werkzeugsatz
PL Zestaw do demontażu radioodbiorników samochodowych
RUS Набор для разборки авто-ресиверов
CZ Sada k demontáži autorádií
H Autorádió kiszerező készlet
RO Trusa de scule pt. indepartat radio
E Juego para el desmontaje de autorradio
CN 收音机拆卸组套

- 2 radio removal U-hook (Ford, VW, Audi, Grundig, Blaupunkt)
- 1 special pentagon wrench (BMW)
- 4 radio removal keys (VW, Audi, Becker, Mercedes)
- 2 radio removal keys (Mercedes, Porsche, Becker)
- 2 radio removal keys (VW)
- 1 allen hex wrench (BMW, Opel)
- 2 radio removal keys (new Becker)
- 2 radio removal keys (new Skoda)
- 2 radio removal keys U-hook (new Blaupunkt)
- 2 radio removal keys (Fiat Brava)
- 2 radio removal U-hook (Opel Doppel-Kugel-Inbus)
- 6 radio removal keys (Mercedes-Benz, BMW)
- 2 radio removal keys (Kenwood II 1998-2001)
- 2 radio removal keys (Sony II since 2002)
- 2 radio removal keys (Kenwood III since 2002)
- 2 radio removal keys (Pioneer, JVC)
- 2 radio removal keys (Sony I until 2001)
- 2 radio removal keys (Panasonic)
- 2 radio removal keys (Kenwood I until 1998)
- 2 radio removal keys (Kenwood mask)
- 2 radio removal keys (new Clarion)
- 2 radio removal keys (old Clarion)
- 2 radio removal keys (Panasonic 2006)
- 2 radio removal keys (Sony IDIC 2005)

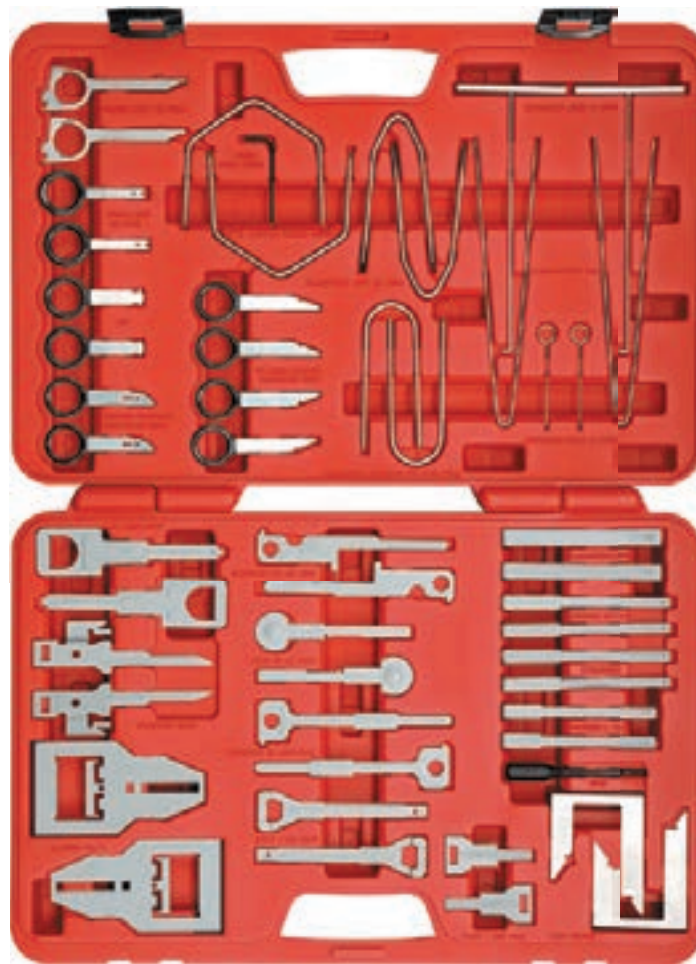

52
PCS

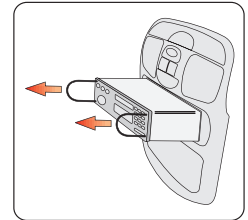
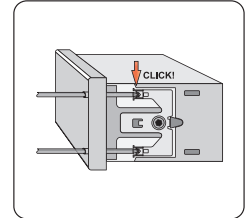
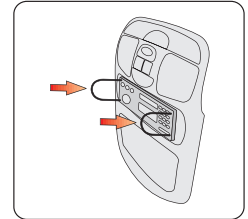

BMC & COLOR SLEEVE



| | |
|-------------|----|
| YATO | |
| YT-0838 | 10 |

GB Emergency automotive lock-out tool set
D Werkzeugsatz zum Öffnen der Autotür im Notfall
PL Zestaw do awaryjnego otwierania drzwi samochodowych
RUS Набор для аварийного відкриття автомобільних дверей
CZ Souprava k nouzovému otevření dveří automobilů
H Személygépkocsi ajtó vésznyitó készlet
RO Set pt. deschiderea de avarie a ușilor de mașină
E Juego de herramientas para abrir las puertas de coche en casos de urgencia
CN 车门锁拆卸工具



9
PCS

STAINLESS STEEL STAL NIERDZEWNA

PVC

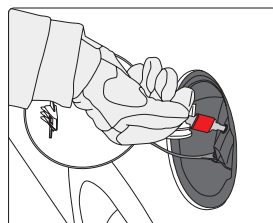
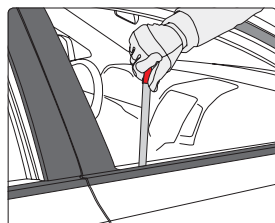
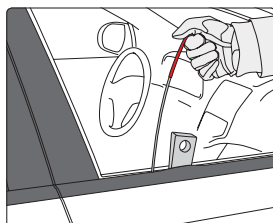
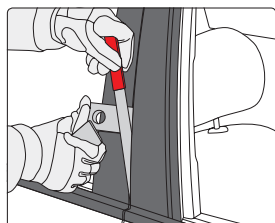

POUCH



| | |
|-------------|----|
| YATO | |
| YT-08385 | 25 |

- GB Universal terminal release tool set
D Werkzeugsatz für Konektorverbindungen
PL Zestaw do złączy konektorowych
RUS Комплект для коннекторных разъемов
CZ Souprava na konektorové spojky
H Szerszámkészlet konnektoros csatlakozásokhoz
RO Set pt. cuplări conectoare
E Juego para conexiones de aflojamiento rápido
CN 端子拆卸器组

12
PCS

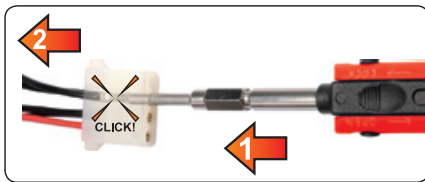

BMC
& COLOR
SLEEVE



| YATO | No. | description / opis | application / zastosowanie | |
|----------|----------|--|--|----|
| YT-08430 | CE-01+11 | ejection tools for contact sizes Ø 1.5 mm w/dismantling sleeves for contact sizes narzędzie do odłączania styków o rozmiarze Ø 1.5 mm wraz z tuleją do demontażu | BMW, Daimler Chrysler, Fiat, MAN, Opel, Porsche, Seat, Skoda, VW, Audi | 10 |
| | CE-02+12 | ejection tools for contact sizes Ø 3.5 mm w/dismantling sleeves for contact sizes narzędzie do odłączania styków o rozmiarze Ø 3.5 mm wraz z tuleją do demontażu | BMW, Daimler Chrysler, Fiat, MAN, Opel, Porsche, Seat, Skoda, VW, Audi | |
| | CE-05+15 | ejection tools for contact sizes Ø 2.3 mm w/dismantling sleeves for contact sizes narzędzie do odłączania styków o rozmiarze Ø 2.3 mm wraz z tuleją do demontażu | Ford, Opel, PSA, Renault | |
| | CE-53 | cable extractor tool for plugs with one release channel 2.8 and 5.8 mm wykrętek do przewodów z pojedynczym złączem 2.8 i 5.8 mm | BMW, Daimler Chrysler, Ford, MAN, Opel, Porsche, PSA, Renault, Seat, Skoda, VW, Audi | |
| | CE-56 | cable extractor tool for Microtimer II, III contacts Ø 1.6 mm wykrętek do przewodów Microtimer II, III styki Ø 1.6 mm | Daimler Chrysler, Opel, Porsche, PSA, Renault, Saab, Seat, Skoda, VW, Audi | |
| | CE-59 | cable extractor tool for Maxipower Timer contacts 9.5 mm wykrętek do styków Maxipower Timer 9.5 mm | Daimler Chrysler, VW, Audi | |
| | CE-62 | cable extractor tool for Pit-Pod contacts wykrętek do styków Pit-Pod | all vehicles wszystkie pojazdy | |
| | CE-74 | cable extractor tool for Microtimer I contacts and ABS plug-in housing Ø 1.6 mm wykrętek do styków Microtimer I i osłony wtyku ABS Ø 1.6 mm | Fiat, Ford, Mazda, Opel, PSA, Renault, Saab, VW, Audi | |
| | CE-91 | cable extractor tool for plugs with two release channels 2.8 and 5.8 mm wykrętek do przewodów z podwójnym złączem 2.8 i 5.8 mm | BMW, Daimler Chrysler, Fiat, Ford, MAN, Opel, PSA, Renault, Saab, VW, Audi | |

- GB Airbag removal tool set
D Schlüssel zur Demontage des Luftkissen
PL Klucze do demontażu poduszki powietrznej
RUS Набор ключей для демонтажа подушки безопасности
CZ Klíče na demontáž airbagu
H Kulcsok légszák leszereléséhez
RO Chei pt. demontare airbag
E Llaves para desmantelamiento de bolsas de aire
CN 安全气囊拆卸组套

12
PCS

HRC
45-50

CrV
6150

16



BMC
& COLOR
SLEEVE



for / dla: BMW, Audi, Opel, Renault, Mercedes, VW Passat, VW Polo, VW Lupo, VW Golf 4, VW Beetle, VW Jetta, VW Bora, Seat, Skoda Fabia, Skoda Octavia

YATO
YT-06291 10



GB Door upholstery remover
D Abziehvorrichtung für Polsterklammern
PL Ściągacz do spinek tapicerki



RUS Съёмник крепежа обивки
CZ Uvolňovač čalounění dveří
H Kárpitkiszedő
RO Dispozitiv de scos agrafe de tapiterie

E Extractor de grapas de vestidura
CN 胶扣起子

SVCM



| YATO  | size / rozmiar (mm) |  |
|--|---------------------|---|
| YT-1370 | 6x100 | 12/120 |

| YATO  | size / rozmiar (mm) |  |
|--|---------------------|---|
| YT-1371 | 6.2x115 | 12/120 |



| YATO | size / rozmiar (mm) | |
|--|---------------------|---|
| YT-1372 | 10x115 | 12/120 |

| YATO | size / rozmiar (mm) | |
|--|---------------------|---|
| YT-1373 | 9.5x134 | 6/96 |

GB Scratch awl
D Einfache Spicknadel
PL Szpikulec prosty

RUS Прямое острѐе
CZ Šidlo rovné
H Spékelőtű, egyenes

RO Dorn perforare drept
E Punzón recto
CN 锥子

SVCM



| YATO | L (mm) | |
|--|--------|---|
| YT-1374 | 120 | 12/120 |

GB Hook bodkin
D Hakenspicknadel
PL Szpikulec hakowy

RUS Крюковое острѐе
CZ Šidlo háčkové
H Spékelőtű, horgos

RO Dorn perforare îndoit
E Punzón encorvado
CN 油封拉拔器

SVCM

45°



90°



| YATO | L (mm) | |
|--|--------|---|
| YT-1376 | 90 | 12/120 |

| YATO | L (mm) | |
|--|--------|---|
| YT-1375 | 125 | 12/120 |

GB Battery cap tool
D Abbrechklngen
PL Ściągacz do клемм akumulatora
RUS Стяжка для клемм аккумулятора
CZ Stahovák svorek akumulátoru

H Akkumulátor saru lehzó
RO Extractor pt. cleme acumulator
E Extractor para los bornes de la batería
CN 扁铲

SVCM



| YATO | size / rozmiar (mm) | |
|--|---------------------|---|
| YT-1378 | 18.5x100 | 12/120 |

GB Glass scraper
D Scheibenkratzer
PL Skrobak do szyb
RUS Шабер для стекла

CZ Škrabka na okna
H Jégkaparó
RO Răzuitor geamuri

E Rascador para los vidrios
CN 刮刀

SVCM



| YATO | size / rozmiar (mm) | |
|--|---------------------|---|
| YT-1379 | 39x200 | 6/72 |

16

GB Spare blades for glass scraper
D Abbrechklngen
PL Ostrze do skrobaka do szyb
RUS Лезвия для универсальных ножей
CZ Lomené ostří náhradní
H Törhető tartalékpenge
RO Lame de rezervă rupte
E Filo partido de recambio
CN 刮刀片



10 PCS

SK5

for / dla: YT-1379



| YATO | size / rozmiar (mm) | |
|--|---------------------|---|
| YT-13790 | 19x39 | 50 |

GB Flexible spinner handle
D Elastischer Dreher
PL Pokrętko elastyczne

RUS Эластичный вороток
CZ Šroubovák ohebný
H Hajlékony csavarhúzó

RO Mâner flexibil
E Llave flexible
CN 套筒螺丝批

1/4" 6.3mm

SVCM



| YATO | size / rozmiar | |
|--|------------------------|---|
| YT-1381 | 1/4" (6.3 mm) x 150 mm | 6/96 |

GB Flexible magnetic bit driver
D Elastischer Dreher für Bits
PL Pokrętko elastyczne do bitów
RUS Эластичный вороток для разряда битов

CZ Šroubovák ohebný na bity
H Hajlékony csavarhúzó bit
RO Mâner flexibil pt. vârf șurubelniță

E Mango flexible para desarmadores
CN 批头螺丝批



| | | |
|-------------|------------------------|------|
| YATO | size / rozmiar | |
| YT-1382 | 1/4" (6.3 mm) x 380 mm | 6/72 |

GB Flexible magnetic pick up tool
D Elastische Magnethalterung
PL Elastyczny uchwyt magnetyczny

RUS Эластичный магнитный держатель
CZ Ohebný magnetický držák
H Hajlékony mágneses szár

RO Mâner magnetic flexibil
E Mango magnético flexible
CN 拾拾器



| | | |
|-------------|--------|------|
| YATO | L (mm) | |
| YT-1385 | 400 | 6/72 |

GB Flexible hose clip screwdriver
D Steckschlüssel, elastisch
PL Klucz nasadowy elastyczny

RUS Эластичный торцевой ключ
CZ Klíč nástrčný ohebný
H Hajlékony dugókulcs

RO Cheie tubulara flexibil
E Llave de tubo flexible
CN 螺帽螺丝批



| | | |
|-------------|---------------------|------|
| YATO | size / rozmiar (mm) | |
| YT-1390 | 6x150 | 6/96 |

| | | |
|-------------|---------------------|------|
| YATO | size / rozmiar (mm) | |
| YT-1391 | 7x150 | 6/96 |

| | | |
|-------------|---------------------|------|
| YATO | size / rozmiar (mm) | |
| YT-1392 | 8x150 | 6/96 |

GB Hook screwdriver
D Winkelschraubendreher
PL Wkrętkak kątowy

RUS Отвёртка
CZ Šroubovák
H Csavarhúzó

RO Șurubelniță
E Destornillador
CN 螺丝批钩子



| | | | |
|-------------|---|-------------|--------|
| YATO | | PCS packing | |
| YT-28480 | 6 | 12 | 36/144 |

GB Universal hook & pick set
D Hacken- und Durchtreiberset
PL Zestaw haków
RUS Набор крюков

CZ Sada háků a šidel
H Kampós ár szet
RO Set șurubelnițe cu varf ascuțit și colțit

E Juego de ganchos
CN 油封拉拔器组套

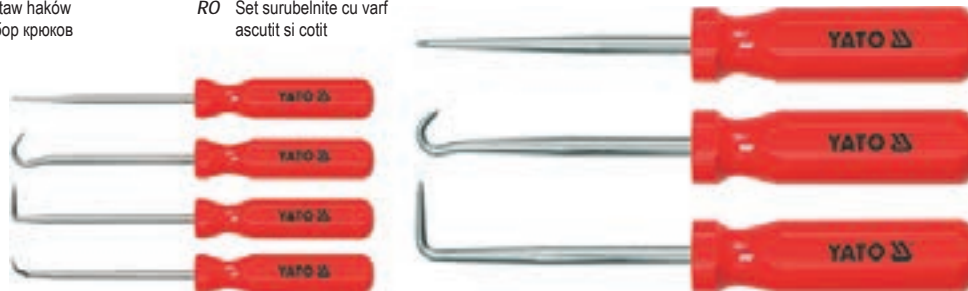

| | |
|-------------|----|
| YATO | |
| YT-0839 | 10 |

GB Door upholstery remover
D Abziehvorrichtung für Polstererklammern
PL Ściągacz do spinek tapicerki

RUS Съемник крепежа обивки
CZ Uvolňovač čalounění dveří
H Kárpitkiszedő
RO Dispozitiv de scos agrafe de tapiterie

E Extractor de grapas de vestidura
CN 胶扣起子



| | | |
|-------------|--------|-------|
| YATO | L (mm) | |
| YT-0841 | 230 | 16/64 |



| | | |
|-------------|--------|--------|
| YATO | L (mm) | |
| YT-0842 | 200 | 25/100 |

- GB Panel removal set
- D Abziehvorrichtung für Polsterung
- PL Ściągacze do tapicerki
- RUS Съемник обивки
- CZ Sada k demontáži čalounění
- H Kárpitlehúzó
- RO Ancore pt. tapiterie
- E Tensores para las vestiduras
- CN 面板拆卸组套

DOUBLE
BLISTER



IMPACT
RESISTANT
NYLON
ODPORNE
NA UDERZENIE

NO SCRATCH
BEZ
ZADRAPAN

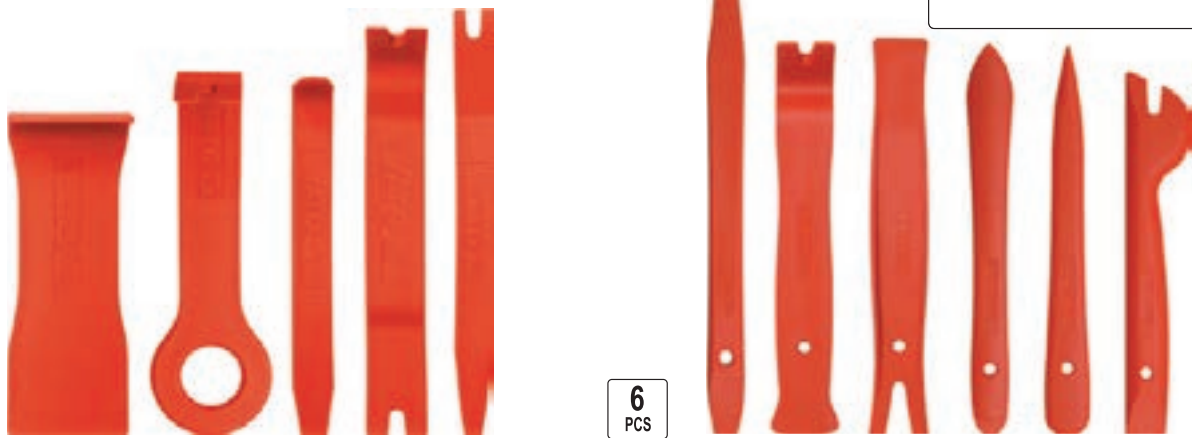
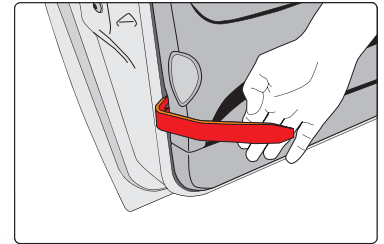

5
PCS

6
PCS

| | |
|-------------|------|
| YATO | |
| YT-0836 | 6/24 |

| | |
|-------------|------|
| YATO | |
| YT-0837 | 6/24 |

- GB Panel removal set
- D Abziehvorrichtung für Polsterung
- PL Ściągacze do tapicerki
- RUS Съемник обивки
- CZ Sada k demontáži čalounění
- H Kárpitlehúzó
- RO Ancore pt. tapiterie
- E Tensores para las vestiduras
- CN 面板拆卸组套

POUCH
& COLOR
BOX



11
PCS

- GB Set of plastic scrapers
- D Satz von Kunststoffschabern
- PL Zestaw skrobaków plastikowych
- RUS Набор пластмассовых шаберов
- CZ Souprava plastových skrabeč

- H Műanyag vakaró készlet
- RO Set de răzuitoare din plastic
- E Juego de rascadores de plástico
- CN 塑料刮刀

4
PCS

265
mm

IMPACT
RESISTANT
NYLON
ODPORNE
NA UDERZENIE

NO SCRATCH
BEZ
ZADRAPAN



SLIDING
CARD



| | |
|-------------|------|
| YATO | |
| YT-0844 | 5/10 |

| | | |
|-------------|--------|------|
| YATO | L (mm) | |
| YT-0847 | 265 | 6/36 |

- GB Multiposition pry bar set
- D Steckschlüsselsatz mit regulierbaren Kopfstück
- PL Zestaw dźwigni z regulowaną główką

- RUS Комплект рычагов с регулируемой головкой
- CZ Sada páčidel s nastaviteľnou hlavou
- H Szabályozható fejú emelőkar készlet

- RO Set de leviere cu cap reglabil
- E Juego de palancas con cabeza ajustable
- CN 多用途撬棒组套

3
PCS

10"
250mm

12"
300mm

15"
380mm

22mm

LOCK
SYSTEM
SYSTEM
BLOKADY

CrV



BMC
& COLOR
SLEEVE



| | |
|-------------|----|
| YATO | |
| YT-06161 | 10 |

| | |
|-------------|----|
| YATO | |
| YT-06161 | 10 |

- GB Quick release cut out tool
D Schneidmesser für Scheiben
PL Nóż do wycinania szyb
RUS Нож для вырезания стекол
CZ Nůž na vyřezávání skel
H Szélvédőkívágó kés
RO Cuțit tăietor de geam
E Cuchilla para cortar cristales
CN 玻璃橡胶刮除器



3x
BLADES
OSTRZA

Alu
HANDLE
UCHWYT

**QUICK
RELEASE**
SZYBKO-
ZŁĄCZE

K5

SLIDING
CARD



- GB Spare blades for cut out tool
D Abbrechklingenn
PL Ostrza zapasowe do noża do wycinania szyb
RUS Лезвя для ножей
CZ Ostří náhradní
H Törhető tartalékpenge
RO Rezerve cutter
E Filo partido de recambio
CN 玻璃橡胶刮除器刀片



3x
BLADES
OSTRZA

K5

for / dla: YT-0659

SLIDING
CARD



3/4" (19 mm);
1" (25 mm);
1-1/2" (38 mm)

YATO
YT-0659 20/40

YATO
YT-06590 10/80

- GB Windshield removal set
D Demontagesatz für Autoscheiben
PL Zestaw do demontażu szyb samochodowych
RUS Набор для демонтажа автостекла
CZ Souprava na demontáž autoskel
H Szélvédőcszerélő szett
RO Set pt. demontarea geamurilor de mașină
E Juego para desmontaje de cristales de coches
CN 风挡玻璃拆卸组套



7
PCS

HRC
38-42

COLOR BOX



YATO
YT-0845 10

- GB Windscreen wiper arm removal tool
D Abziehvorrichtung für die Scheibenwischerarme
PL Ściągacz do ramion wycieraczek
RUS Съемник поводков стеклоочистителя
CZ Stahovák na ramínka stěračů
H Ablaktörllökar le húzó
RO Siguranță pt. brațele ștergătoarelor
E Herramienta para desmontaje de las plumas de los limpiaparabrisas
CN 雨刷臂拆卸工具

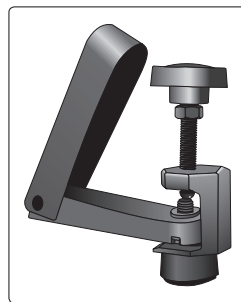

SLIDING
CARD



YATO
YT-0846 12/120

- GB Air condition repair set
D Schlüsselsatz für die Klimatisierung
PL Zestaw kluczy do klimatyzacji
RUS Набор ключей для кондиционеров
CZ Sada klíčů na klimatizace
H Kulcskészlet légkondicionáléhoz
RO Set de chei pt. aer condiționat
E Juego de llaves para los sistemas de aire acondicionado
CN 空调维修工具组套



12
PCS

1/4"
6.3mm

FOR A/C
DO KLIMA-
TYZACJI

CrV

S2

8 POINTS
8 PUNKTÓV

1/4" (6.3 mm): 2.2 mm, 3.2 mm; CrV;

1/4" (6.3 mm): 12 mm, 15 mm; CrV;

1/4" (6.3 mm); CrV;

1/4" (6.3 mm): TS10, TS15, TS20, TS25, TS27, TS30, TS40; L=25 mm; AISI S2

BMC
& COLOR
SLEEVE



YATO
YT-06271 10/40

- GB CV boot clamp pliers
- D Zange für Schellen der Gelenkabdeckung
- PL Szczypce do opasek osłony przegubu
- RUS Щипцы для хомутов крепления кожуха шарнира
- CZ Kleště na spony manžety kloubu
- H Féltengely bilincs húzó fogó
- RO Clește pt. brățară de husă la articulație
- E Alicates para abrazadera de protección de la junta
- CN 夹紧钳

SLIDING CARD



235 mm
CrV

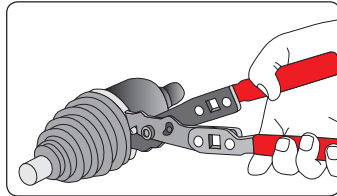
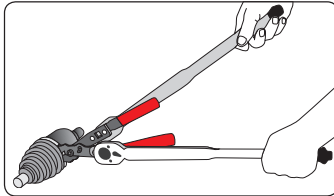

| | | |
|-------------|--------|------|
| YATO | L (mm) | |
| YT-0606 | 235 | 6/36 |

- GB Lock-ring pliers
- D Spreizzange für Schellen
- PL Szczypce rozporowe do pierścieni osadzczych
- RUS Щипцы распорные для стяжных хомутов
- CZ Kleště na hadicové spony
- H Seeger fogó
- RO Clește pt. desfacerea brățarelor de strângere
- E Alicates para abrazaderas
- CN C型扣钳

SLIDING CARD



225 mm
CrV

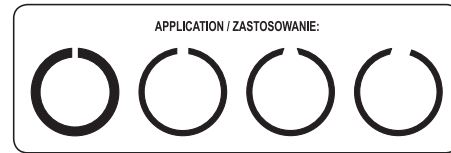
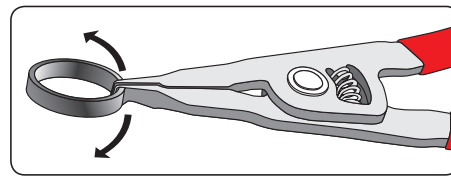

| | | |
|-------------|--------|-------|
| YATO | L (mm) | |
| YT-0607 | 225 | 12/72 |

- GB Fuel feel pipe pliers
- D Zange für Tankverschlüsse
- PL Szczypce do złączek paliwowych
- RUS Щипцы для топливных соединений
- CZ Kleště na spojky palivového systému
- H Üzemanyagvezeték fogó
- RO Clește pt. conectoare de combustibil
- E Alicates para enchufes de combustible
- CN 油管钳

SLIDING CARD



Al

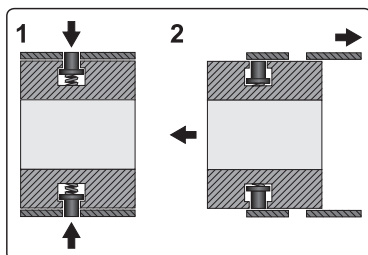
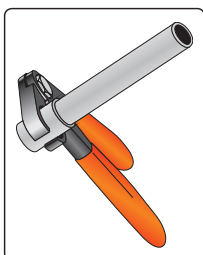

| | |
|-------------|-------|
| YATO | |
| YT-0608 | 10/40 |

- GB Hose removing pliers
- D Schlauch- und Kabellösezange
- PL Szczypce do zdejmowania przewodów
- RUS Клещи для снятия изляци
- CZ Kleště na demontáž hadic
- H Tömölbilincs fogó
- RO Clește pt. îndepărtat furtune
- E Alicates de extracción de mangueras
- CN 油管分离钳

SLIDING CARD



ø5-15mm

5-30mm



| | |
|-------------|------|
| YATO | |
| YT-0657 | 6/36 |

- GB Transmission line disconnect tool set
D Werkzeugsatz zum Trennen von Kraftstoffleitungen
PL Zestaw do rozłączania przewodów
RUS Набор для рассоединения топливопроводов
CZ Sada na rozpojování palivového potrubí
H Üzemanyagcső-lebontó készlet
RO Set pt. deconectarea liniilor de combustibil
E Juego para desconectar conductos de combustible
CN 油管拆卸组套



8 PCS
FOR A/C
DO KLIMATYZACJI
FOR FUEL LINE
DO PRZEWODÓW PALIWA



BMC & COLOR SLEEVE

| | | |
|-------------|--|----|
| YATO | | |
| YT-0630 | | 20 |

- GB Spark plug terminal pliers
D Zange für das Zündkerzenkabel
PL Szczypce do przewodów świec zapłonowych
RUS Щипцы к проводам свечей зажигания
CZ Kleště na kabely zapalovacích svíček
H Gyújtógyertya-kábel fogó
RO Clește pt. conductele bujilor de aprindere
E Pinzas para los cables de las bujías de ignición
CN 火花塞高压线钳

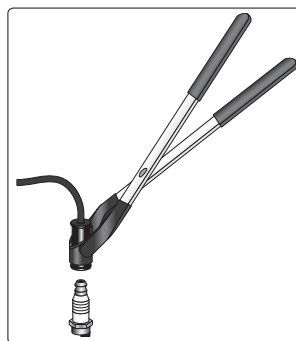

SLIDING CARD



200 mm
255 mm



| | | |
|-------------|--------|-------|
| YATO | L (mm) | |
| YT-0639 | 200 | 12/96 |

| | | |
|-------------|--------|-------|
| YATO | L (mm) | |
| YT-7320 | 255 | 10/60 |

- GB Multi-purpose hose & wire pliers
D Zangensatz für Schellen und Leitungen
PL Komplet szczypiec do opasek i przewodów
RUS Набор щипцов к хомутам и проводам
CZ Souprava kleští na spony a hadice
H Fogókészlet bilincsekhez és vezetékekhez
RO Set clește pt. benzi și conducte
E Juego de pinzas para abrazaderas y cables
CN 多功能管夹钳

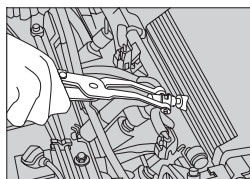

For engine air pipe
Do przewodów powietrznych listwy wtryskowej

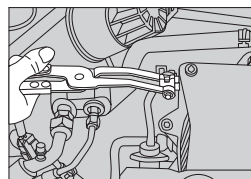

For engine intake air pipe
Do przewodów gumowych układu zasilania

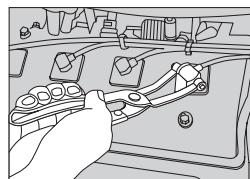

For spark plug lead
Do przewodów zapłonowych

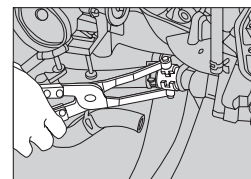

For cooling water pipe
Do przewodów gumowych układu chłodzenia

2 PCS

1/4"-3/4"

6.3-19.0 mm

217 mm

254 mm



SLIDING CARD



| | | |
|-------------|--------|------|
| YATO | L (mm) | |
| YT-0645 | 217 | 6/24 |
| | 254 | |

GB Hose clamp pliers
 D Zange zum Entspannen der Klemmschellen
 PL Szczypce do opasek zaciskowych rozprężnych
 RUS Щипцы к хомутам зажимным распорным
 CZ Kleště na samosvorné hadicové spony

H Vízcsőbilincs fogó
 RO Clește pt. benzile de strângere destindere
 E Pinzas para las abrazaderas de expansión
 CN 管夹钳

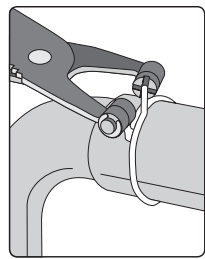

SLIDING CARD



215 mm



2 mm

LOCK SYSTEM SYSTEM BLOKADY

ALLOY STEEL AISI 4130

| YATO | L (mm) | |
|---------|--------|-------|
| YT-0646 | 215 | 12/72 |

GB Hose clamp pliers
 D Zange zum Entspannen der Klemmschellen
 PL Szczypce do opasek zaciskowych rozprężnych
 RUS Щипцы к хомутам зажимным распорным
 CZ Kleště na samosvorné hadicové spony

H Vízcsőbilincs fogó
 RO Clește pt. benzile de strângere destindere
 E Pinzas para las abrazaderas de expansión
 CN 管夹钳

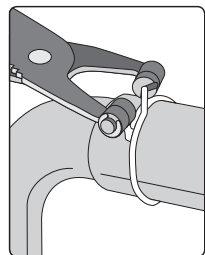

SLIDING CARD



215 mm



4.5 mm

LOCK SYSTEM SYSTEM BLOKADY

ALLOY STEEL AISI 4130

| YATO | L (mm) | |
|---------|--------|-------|
| YT-0647 | 215 | 12/72 |

GB Hose clamp pliers
 D Zange zum Entspannen der Klemmschellen
 PL Szczypce do opasek zaciskowych rozprężnych
 RUS Щипцы к хомутам зажимным распорным
 CZ Kleště na samosvorné hadicové spony

H Vízcsőbilincs fogó
 RO Clește pt. benzile de strângere destindere
 E Pinzas para las abrazaderas de expansión
 CN 管夹钳



SLIDING CARD



4 mm

∅ 12 mm

LOCK SYSTEM SYSTEM BLOKADY

HRC 40

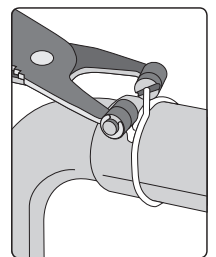

230 mm

| YATO | L (mm) | |
|---------|--------|------|
| YT-0650 | 230 | 6/36 |



215 mm

| YATO | L (mm) | |
|---------|--------|------|
| YT-0651 | 215 | 6/36 |

GB Exhaust pipe clamp pliers
 D Auspuffschellen-Sicherungszange
 PL Szczypce do opasek wydechu
 RUS Щипцы для пружинных зажимов
 CZ Kleště na spony výfuku

H Kipufogóbilincs fogó
 RO Auspuffe pt. coliere teava de esapament
 E Pinzas para bridas del tubo de escape
 CN 排气管夹钳



SLIDING CARD



300 mm

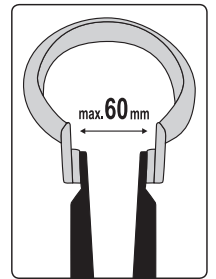

| YATO | L (mm) | |
|---------|--------|-------|
| YT-0652 | 300 | 10/40 |

for / dla: Peugeot, Citroën, Renault, Fiat, Ford

GB Valve stem seal pliers
D Lange Zange für Ventildichtringe
PL Szczypce do uszczelnaczy zaworowych, długie
RUS Щипцы для замены маслосъемных колпачков
CZ Kleště na těsnění ventilů, dlouhé

H Szelepszár szimering fogó hosszú
RO Clește cu picior lung pt. sigilat supape
E Pinzas para juntas de vástago válvula
CN 气门油封钳

SLIDING
CARD



270
mm

FOR VALVE
STEM SEALS
DO USZCZELNIAZY
ZAWOROWYCH

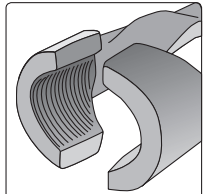

NON-SLIP



| YATO | L (mm) | |
|---------|--------|-------|
| YT-0648 | 270 | 12/60 |

GB Pliers for band clips with a cord
D Zange für Rohrschellen mit Seil
PL Szczypce z linką do opasek zaciskowych
RUS Щипцы к зажимным хомутам с тросиком
CZ Kleště s lankem na samosvorné hadicové spony

H Flexibilis bowdenes vízcsőbilincs fogó
RO Clește pt. cleme de prindere frânghie
E Pinzas para bandas de apretadura con cuerda
CN 延长型弹性管夹钳

SLIDING
CARD



CrMo
4140

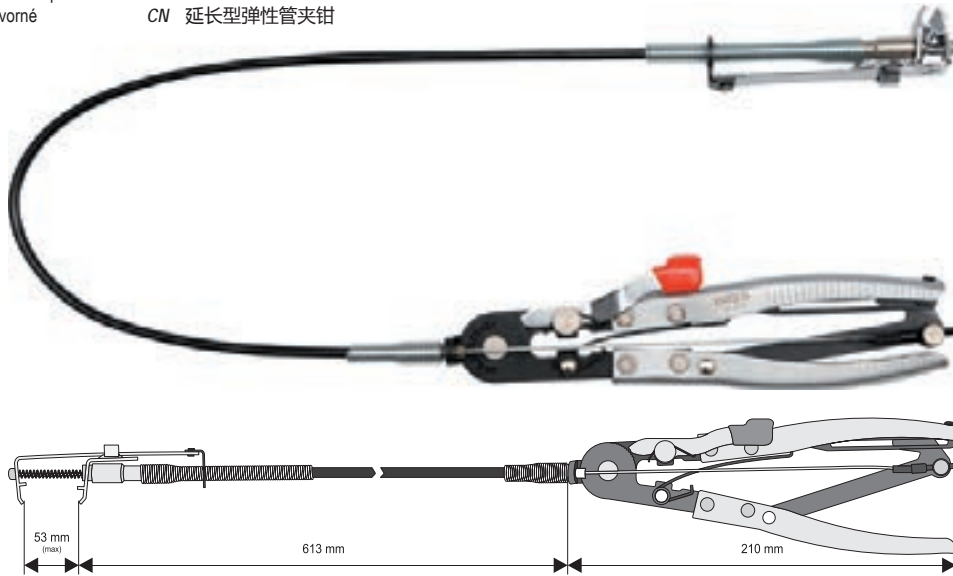

| YATO | | |
|---------|--|-------|
| YT-0653 | | 12/36 |

GB Pliers for band clips with a cord
D Zange für Rohrschellen mit Seil
PL Szczypce z linką do opasek zaciskowych
RUS Щипцы к зажимным хомутам с тросиком
CZ Kleště s lankem na samosvorné hadicové spony

H Flexibilis bowdenes vízcsőbilincs fogó
RO Clește pt. cleme de prindere frânghie
E Pinzas para bandas de apretadura con cuerda
CN 延长型弹性管夹钳

SLIDING
CARD



CrMo
4140



| YATO | | |
|---------|--|----|
| YT-0677 | | 25 |

GB Water pump pulley locking wrench
 D Schlüssel für die Wasserpumpe
 PL Klucz do pompy wodnej
 RUS Ключ к водному насосу
 CZ Klič na vodní čerpadlo

H Vizpumpafogó
 RO Cheie pt. pompe de apă
 E Llave para la bomba de agua
 CN 水泵皮带轮扳手

SLIDING CARD



245 mm

285 mm

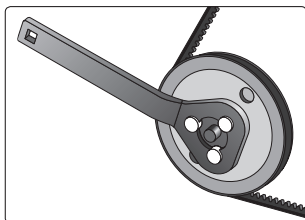

Volkswagen and Audi without air condition
 Volkswagen i Audi bez klimatyzacji



Volkswagen and Audi with air condition
 Volkswagen i Audi z klimatyzacją

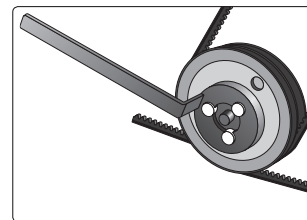

| | | |
|-------------|--------|------|
| YATO | L (mm) | |
| YT-0539 | 245 | 6/36 |

| | | |
|-------------|--------|------|
| YATO | L (mm) | |
| YT-0540 | 285 | 6/36 |

GB Universal pulley holder & fan clutch set
 D Schlüssel zum Spannen der Riemenscheibe
 PL Klucz do napinania kola pasowego

RUS Ключ для натягивания шкива
 CZ Klič k napínání řemenice
 H Szijtárcsa feszítő kulcs
 RO Cheie pt. întindere roată de curea

E Llave tensora para polea
 CN 多用途皮带轮扳手



11 PCS

BMC & COLOR SLEEVE

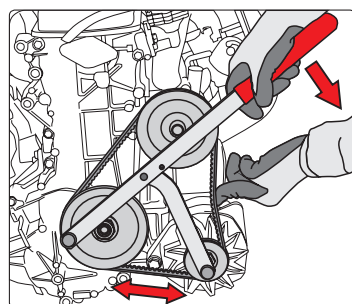

Ø 6-10 mm;
 Ø 8-11 mm;
 Ø 10-12 mm;
 Ø 11-16 mm

| | |
|-------------|---|
| YATO | |
| YT-0627 | 8 |

GB Piston ring compressor
 D Kolbenring-Spannband
 PL Zaciskacz do pierścieni
 RUS Оправка поршневых колец
 CZ Svěrka na kroužky

H Gyűrűbepattintó
 RO Clește pt. strâns inele
 E Apretador de anillos
 CN 活塞环压缩机

AISI # 301

SK5

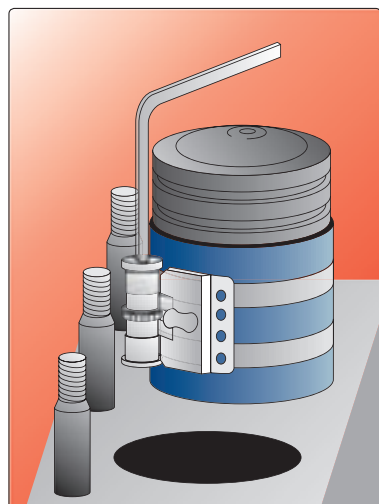

COLOR BOX



| | | | |
|-------------|--------|--------|-------|
| YATO | Ø (mm) | H (mm) | |
| YT-0635 | 50-125 | 75 | 30/60 |
| YT-0636 | 90-175 | 100 | 30/60 |
| YT-0637 | 90-175 | 150 | 20/40 |

GB Twin cam locking tool for petrol & diesel engines
D Universelle Blockade der Steuerwellen
PL Uniwersalna blokada wałków rozrządu
RUS Универсальный набор блокировки распредвала
CZ Univerzální přípravek na zablokování rozvodných hřídelí

H Univerzális vezérműtengely rögzítő
RO Blocadă universală arbore de direcție
E Bloqueo universal de eje de distribución
CN 双凸齿轮固定器

FOR PETROL
& DIESEL ENGINES
DO SILNIKÓW DIESLA
I BENZYNOWYCH

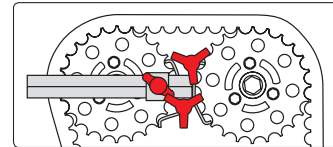

SLIDING
CARD



YATO
YT-06011 10/20

GB Camshaft locking tool
D Nockenwellen-Arretierwerkzeug
PL Przyrząd do blokowania kół rozrządu
RUS Инструмент для блокирования распределительных механизмов
CZ Přípravek k montáži rozvodových kol
H Vezérlés rögzítő szerszám
RO Arbore cu came
E Aparato para bloquear el árbol de levas
CN 正时皮带固定器

SLIDING
CARD



48
mm

GB Diesel engine locking setting kit
D Blockade für die Steuerräder
PL Blokada do kół rozrządu
RUS Блокировка к колесам распределительных механизмов
CZ Souprava na fixaci rozvodových kol

H Diesel motor rögzítő készlet
RO Blocadă roțiilor distribuție
E Bloqueo para las poleas del mecanismo de distribución
CN 正时皮带更换工具

3
PCS

FOR VALVETRAIN
DO UKLADU
ROZRZĄDU

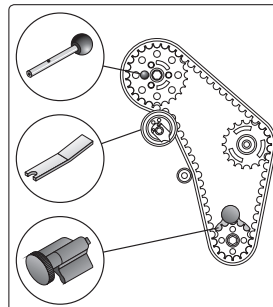

SLIDING
CARD



VW: Lupo, Polo, Golf / Bora, Beetle, Caddy, Sharan, Touran, Transporter (1998-2006);
AUDI: A2, A3, A4, A6;
FORD: Galaxy (2000-2006);

SEAT: Arosa, Ibiza, Cordoba, Leon, Toledo, Alhambra (1999-2005);
SKODA: Fabia, Octavia (2000-2006)
3 i 4 cyl 1.2, 1.4, 1.9 TDI PD
2.0 SDI, 2.0 TDI PD

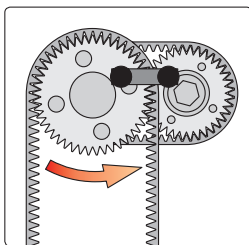

VW Lupo since 1999
VW Polo since 1995
VW Caddy since 1996
VW Polo Classic since 1996

VW Polo Variant since 1996
VW New Beetle 1.4 I
VW Golf 1.4 I, 1.6 I since 1998
VW Bora 1.4 I, 1.6 I since 1999

YATO
YT-0601 6/36

YATO
YT-0632 10/50

GB Timing locking set
D Arretierwerkzeugsatz für Nockenwellen
PL Zestaw blokad rozrządu
RUS Набор блокировок к колесам распределительных механизмов

CZ Blokovací sada pro opravy rozvodů
H Vezérműrögzítő szerszámkészlet
RO Set blocare distributie auto
E Juego de bloqueos de distribución
CN 正时皮带固定器组套

4
PCS

FOR VALVETRAIN
DO UKLADU
ROZRZĄDU

FOR GASOLINE
ENGINES
DO SILNIKÓW
BENZYNOWYCH

DROP
FORGED
KUTE

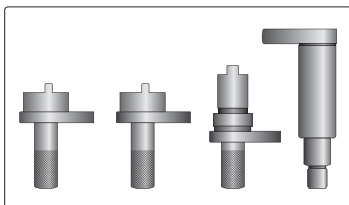
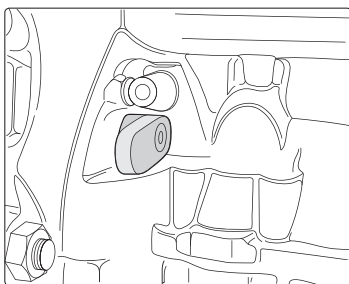
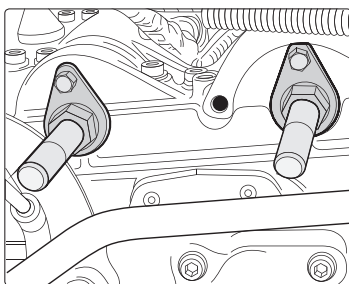

Timing locking set for engines 1.2 6V / 12V (chain)

Zestaw blokad rozrządu silników 1.2 6V / 12V (łańcuch)

APPLICATION:
VW, SKODA, SEAT 1.2 12V and 1.2 6V (HTP);
VW: Polo;
SEAT: Ibiza, Cordoba;
SKODA: Fabia HTP;
Engine codes AZQ, AWY, BMD, BME (02-07).

ZASTOSOWANIE:
VW, SKODA, SEAT 1.2 12V i 1.2 6V (HTP);
VW: Polo;
SEAT: Ibiza, Cordoba;
SKODA: Fabia HTP;
Silniki o kodzie AZQ, AWY, BMD, BME (02-07).

SET INCLUDES:
• camshaft locking pin 1 pc
• crankshaft locking pin 1 pc
• camshaft locking clamps 2 pcs

ZESTAW ZAWIERA:
• trzpień blokujący wałek rozrządu 1 szt.
• trzpień blokujący wał korbowy 1 szt.
• zacisk blokujący wałki rozrządu 2 szt.



YATO
YT-06012 20

GB Timing locking set
 D Arretierwerkzeugsatz für Nockenwellen
 PL Zestaw blokad rozrządu
 RUS Набор блокировок к колесам распределительных механизмов
 CZ Blokovací sada pro opravu rozvodů
 H Vezérműrogzító szerszámkészlet
 RO Set blocare distributie auto
 E Juego de bloqueos de distribución
 CN 正时皮带固定器组套



8
PCS

AI

BMC & COLOR SLEEVE

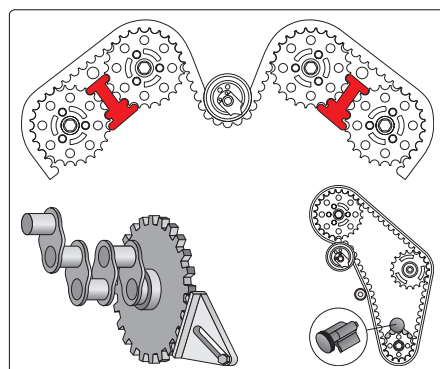

| YATO | No. | No. | |
|---------|-----|---|----|
| YT-0633 | | Vauxhall/Opel: ASTRA G 1.7 TD, ASTRA G 2.0 16V, VECTRA 1.8/2.0 16V > 1995 | |
| | | Vauxhall/Opel: ASTRA G 1.4/1.6/1.8 16V > 1994, VECTRA 1.6/1.8 16V, ZAFIRA 1.6/1.8 16V | |
| | | right hand camshaft Saab: 900-9000 Vauxhall/Opel: CALIBRA 2.5/2.5i/2.6 V6, CAVALIER 2.5i V6, OMEGA B 2.5/2.6/3.0/3.2 V6, SINTRA 3.0 V6, VECTRA A 2.5i/2.6 V6 | |
| | | left hand camshaft Saab: 900-9000 Vauxhall/Opel: CALIBRA 2.5/2.5i/2.6 V6, CAVALIER 2.5i V6, OMEGA B 2.5/2.6/3.0/3.2 V6, SINTRA 3.0 V6, VECTRA A 2.5i/2.6 V6 | |
| | | Rover: 25 1.4/1.6/1.8/VVC, 45 1.4/1.6/1.8, 75 1.8, 200 VI, 214 16V, 216 16V/CABRIO/COUPE, 218 COUPE, 414 16V, 416 16V, BRM 1.8VVC | |
| | | Volkswagen: BORA 1.9TDI, GOLF 1.9TDI, LUPO 1.2/1.4/3.0 TDI, POLO 1.4TDI PASSAT 1.9TDI | |
| | | Citroen: BERLINGO 1.9D, DISPATCH 1.9D/TD-FSO 1.9D, RELAY 1.9D/TD, SYNERGIE 1.9/2.0T, SANTIA 1.9/2.0 D/TD/HDI, XSARA 1.9/2.0 D/HDI, ZX 1.9D/TD, most diesels Fiat: DUCATO 2.0D, ULYSSE 1.8/2.0 TURBO Ford: most diesels Peugeot: 205 1.6/1.8/1.9D, 305 1.6/1.8/1.9D, 306 1.8/1.9D/TD, 309 1.6/1.9D-4.5 1.6/1.9D, 406 1.9D, 605 2.0D/TD, 806 1.9TD, BOXER 1.9/2.0 D/TD, EXPERT 1.9D, PARTNER 1.9D Talbot: EXPRESS D, HORIZON D-J5 D, SOLARA D | 16 |
| | | Isuzu: 1.5/1.7 diesel engines Vauxhall/Opel: 1.6/1.7 diesel engines, 1.2/1.4/1.6/1.8/2.0 OHC petrol engines | |

GB Diesel injector puller
 D Stoßabziehvorrichtung für Einspritzdüse
 PL Ściągacz bezwładnościowy do wtryskiwaczy
 RUS Ударный съемник форсунок
 CZ Rázový vytahovač vstříkovačů
 H Diesel porlasztó kisedő
 RO Dispozitiv de scos injectoare
 E Tuerca tensora de impacto para inyectoros
 CN 柴油喷嘴拔取器

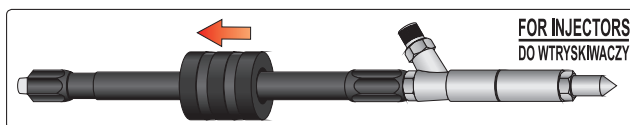

BOSCH TYPE LUCAS TYPE M8 M12 M14



BMC & COLOR SLEEVE



YATO
YT-0617 20

GB Overhead valve spring compressor
 D Vorrichtung zur Demontage von Motorventilen
 PL Przyrząd do demontażu zaworów silnikowych
 RUS Устройство для демонтажа клапанов двигателя
 CZ Přípravek na demontáž ventilů motoru
 H Szeplehúzó készülék
 RO Dispozitiv pt. demontarea supapelor la motoare
 E Instrumento para desmontaje de válvulas de motor
 CN 下压式凡尔钳



SLIDING CARD

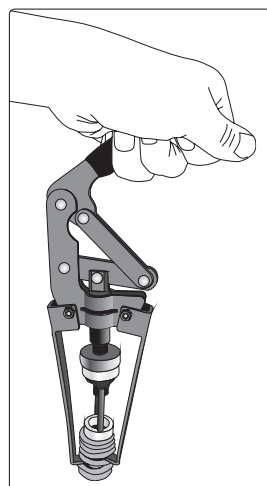

YATO
YT-0618 5/25

- GB Lambda sensor thread chaser
D Lambdasonde gewinde reparatur-set
PL Zestaw do naprawy gwintów sondy lambda
RUS Набор для ремонта сорванной резьбы винтов
CZ Sada na opravu závitu Lambda sondy
H Menetjavító készlet Lambda szondához
RO Dispozitiv pt. curatat filet sonda lambda
E Cazador del hilo de rosca para sonda lambda
CN 火星塞攻组套

FOR OXYGEN SENSOR DO SONDY LAMBDA

HRC 50

M12 x 1.25

M18 x 1.5



SLIDING CARD

| | |
|-------------|-------|
| YATO | |
| YT-1756 | 12/96 |

- GB Oxygen sensor crowfoot wrench
D Schlüssel für die Lambdasonde
PL Klucz do sondy lambda
RUS Ключ для зонда лямбда

- CZ Klíč na sondu lambda
H Lambda szonda kulcs
RO Cheie pt. sonda lambda
E Llave para la sonda lambda
CN 氧传感器套筒扳手

SLIDING CARD



22 mm

FOR OXYGEN SENSOR DO SONDY LAMBDA



CrMo SCM-440

| | |
|-------------|----|
| YATO | |
| YT-1753 | 60 |



CrV 50BV30

| | |
|-------------|------|
| YATO | |
| YT-1754 | 6/36 |

- GB Socket and oxygen sensor set
D Steckschlüssel für die Lambda-Sonde
PL Klucze nasadowe do sondy lambda
RUS Торцовые ключи с внутренним многогранником для зонда лямбда
CZ Nástrčné kľúče na sondy lambda
H Dugókulcs lambda szondához
RO Prize pt. sonda lambda
E Llaves de cubo para la sonda lambda
CN 氧传感器套筒扳手套组

- 22 mm; L= 50 mm; 6PT; CrMo SCM440;
 22 mm; L=30 mm; 6PT; CrMo SCM440;
 22 mm; L=80 mm; 6PT; CrV 50BV30



3 PCS 22 mm FOR OXYGEN SENSOR DO SONDY LAMBDA

CrMo SCM-440 CrV 50BV30

BMC & COLOR SLEEVE



| | |
|-------------|----|
| YATO | |
| YT-1752 | 20 |

- GB Oxygen sensor and fuel injectors wrench set
D Steckschlüsselsatz für die Lambdasonde und die Einspritzdüsen
PL Zestaw nasadek do sondy lambda i wtryskiwaczy
RUS Набор насадок к лямбда-зондам и форсункам
CZ Sada nástavců na demontáž sondy lambda a vstříkovačů
H Dugókészlet lambda szondákhoz és injektorokhoz
RO Set inelare pt. sonda lambda și injectoare
E Juego de boquillas para la sonda lambda y para inyectores
CN 氧传感器套筒扳手套组

- 1/2" (12.7 mm) x 29 mm; L=90 mm; 6PT;
 3/8" (9.5 mm) x 22 mm; L=90 mm; 6PT;
 1/2" (12.7 mm) x 27 mm; L=78 mm; 12PT;
 3/8" (9.5 mm) x 27 mm; L=74 mm; 6PT;
 3/8" (9.5 mm) x 22 mm; L=80 mm; 6PT;
 1/2" (12.7 mm) x 22 mm; L=50 mm; 6PT;
 3/8" (9.5 mm) x 22 mm; L=30 mm; 6PT



7 PCS 1/2" 12.5mm 3/8" 10mm

CrMo SCM-440 CrV 50BV30 FOR OXYGEN SENSOR DO SONDY LAMBDA

FOR FUEL INJECTORS DO WTRYSKÓW PALWA

BMC & COLOR SLEEVE



| | | |
|-------------|---------------------------------|---|
| YATO | size / rozmiar | |
| YT-1751 | 1/2" (12.7 mm) 3/8" (9.5 mm) | 5 |

- GB** Diesel injection socket set
D Aufsätze für die Einspritzungen bei Dieselmotoren
PL Zestaw nasadek do wtrysków w silnikach Diesla
RUS Набор насадок к форсункам в дизельных двигателях
CZ Sada nástavců na trysky dieselových motorů
H Szerszámkészlet Dieselmotor befecskendezőkhöz
RO Set de capete pt. injectoare in motoare Diesel
E Juego de tapones para las inyecciones en los motores de Diesel
CN 柴油机加注套组套



6 PCS
1/2"
12.5mm
AS-DRIVE
CrV

FOR FUEL INJECTORS
 DO WTRYSKÓW PALIWA



BMC & COLOR SLEEVE

21x90; 22x78; 22x110; 27x78; 28x78; 28x83 mm

| YATO | size / rozmiar | |
|---------|----------------|----|
| YT-0622 | 1/2" (12.7 mm) | 10 |

- GB** Diesel injector and cutter set
D Fräsersatz für die Buchsen der Einspritzdüsen
PL Zestaw frezów do gniazd wtryskiwaczy common rail
RUS Комплект фрез для гнезд сопл форсунок
CZ Sada fréz na sedla trysek vstříkovačů
H Marókészlet befecskendező fúvókájának fészkéhez
RO Set de freze pt. socluri de duze injectoare
E Juego de fresas para el asiento de toberas de inyectores
CN 7件套气门铰刀



7 PCS

CrMoV
SKD11

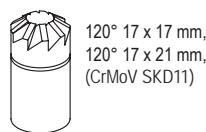
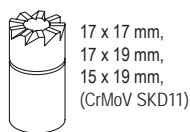
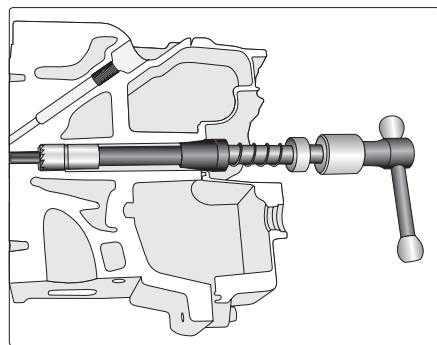

BMC & COLOR SLEEVE



| YATO | | |
|----------|--|----|
| YT-17625 | | 10 |

16

- GB** Tooth socket for injection nozzle
D Stiftschlüsselsatz für die Einspritzdüse in Lastkraftwagen
PL Zestaw kluczy czopowych do wtryskiwaczy w samochodach ciężarowych
RUS Набор шиповых ключей к форсункам грузовых автомобилей
CZ Sada klíčů na vstříkovače pro nákladní automobily
H Csapосkulcs készlet tehergépkocsi befecskendezőjéhez
RO Set chei tubulare cu ungera pt. camioane
E Juego de llaves de muñon para los inyectores en camiones
CN 卡车喷油嘴套筒组套



4 PCS
1/2"
12.5mm
HEX

CrMo
S45C
CrV

FOR FUEL INJECTORS
 DO WTRYSKÓW PALIWA



BMC & COLOR SLEEVE

- ⊙ 1/2" (12.7 mm); L=72 mm; 4T; CrV;
- ⊙ 32 mm; M14 x 1.5 mm; L=70 mm, 4T; S45C;
- ⊙ 1/2" (12.7 mm); L=120 mm; 3T; CrMo;
- ⊙ 32 mm; L=120 mm, 4T; S45C

| YATO | size / rozmiar | |
|---------|----------------|----|
| YT-1762 | 1/2" (12.7 mm) | 16 |

GB Fuel injection test kit
D Diagnosesatz für die Prüfung der Kraftstoffeinspritzung
PL Zestaw diagnostyczny do wtrysku paliwa
RUS Пневматический набор к тормозным зажимам
CZ Souprava k diagnostice vstřikování paliva

H Diagnosztikai készlet üzemanyag - befecskendőzökhöz
RO Ansamblu pt. diagnosticarea injectiei combustibilului
E Juego de herramientas diagnosticas para la inyección de combustible
CN 燃料注射测试组套

10
PCS

P max.
0.7 MPa

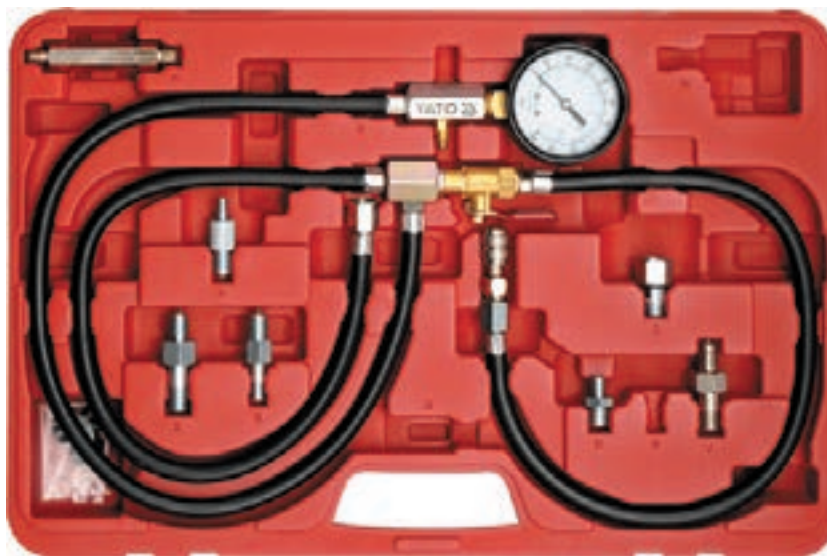

BMC
& COLOR
SLEEVE



| | |
|-------------|----|
| YATO | |
| YT-0670 | 10 |

GB Compression pressure gauge in a diesel engine
D Kompressionsdruckmesser in Dieselmotoren
PL Miernik ciśnienia sprężania w silnikach diesla
RUS Измеритель давления компрессии в дизельных двигателях
CZ Souprava k měření kompresních tlaků v dieselových motorech

H Dieselmotorok kompressióját mérő óra
RO Manometrul presiunii aerului comprimat pt. motoarele diesel
E Medidor de presión de la compresión en los motores diesel
CN 柴油机压力测试组套

16
PCS

70 bar
max.

FOR DIESEL
ENGINE
DO SILNIKÓW
DIEŚLA

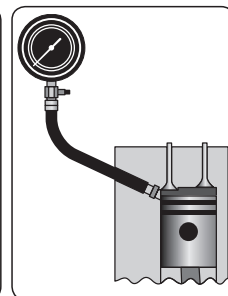
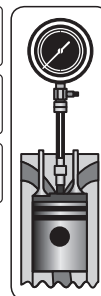

70 bar, 500 mm;

160 mm;

M20x1.5: 75 mm; M22x1.5: 73 mm; M24x1.5: 88 mm; M24x2: 63 mm;

M10x1: 83, 91, 102, 113, 119 mm; M10x1.25: 64, 135 mm; M12x1.25: 47 mm; M22x1.5: 118 mm;



BMC
& COLOR
SLEEVE



| | |
|-------------|---|
| YATO | |
| YT-7307 | 5 |

GB Compression tester
 D Druckluftmessgerät
 PL Miernik ciśnienia sprężania
 RUS Тестер компрессии

CZ Měřicí přístroj
 kompresního tlaku
 H Kompresszió mérő

RO Aparat de măsurarea presiunii
 E Medidor de compresión
 CN 气缸压力表

FOR ALL TYPES
 DO WSZYSTKICH
 TYPOW



21 bar
 max.

FOR SPARK
 IGNITION
 DO ZAPŁONU
 ISKROWEGO

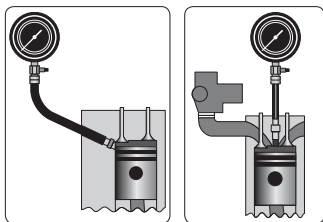

BMC
 & COLOR
 SLEEVE

RUBBER
 ADAPTOR
 ZŁĄCZE
 GUMOWE



THREADED
 ADAPTOR
 ZŁĄCZE
 GWINTOWANE



THREADED
 ADAPTOR
 ZŁĄCZE
 GWINTOWANE

RUBBER
 ADAPTOR
 ZŁĄCZE
 GUMOWE

| | | | | | |
|-------------|-------|-------------|-------|-------------|------|
| YATO | | YATO | | YATO | |
| YT-7300 | 24/48 | YT-7301 | 12/24 | YT-7302 | 6/24 |

GB Flow meter common rail adapter set
 D Überlauf-Diagnosesatz für die Einspritzdüse Common rail
 PL Przelewowy zestaw diagnostyczny do wtryskiwaczy common rail
 RUS Диагностический набор к форсункам common rail; переливной common rail; прúтоková
 CZ Souprava na diagnostiku vstřikovačů common rail, průtoková
 H Diagnosztikai készlet common rail injektorokhoz, átfolyós
 RO Set diagnostic preaplin pt. injectoare common rail
 E Juego diagnóstico de flujo para inyectoros common rail
 CN 柴油燃油喷嘴检测工具

31
 PCS

FOR
 6 CYLINDERS
 DO
 6 CYLINDRÓW

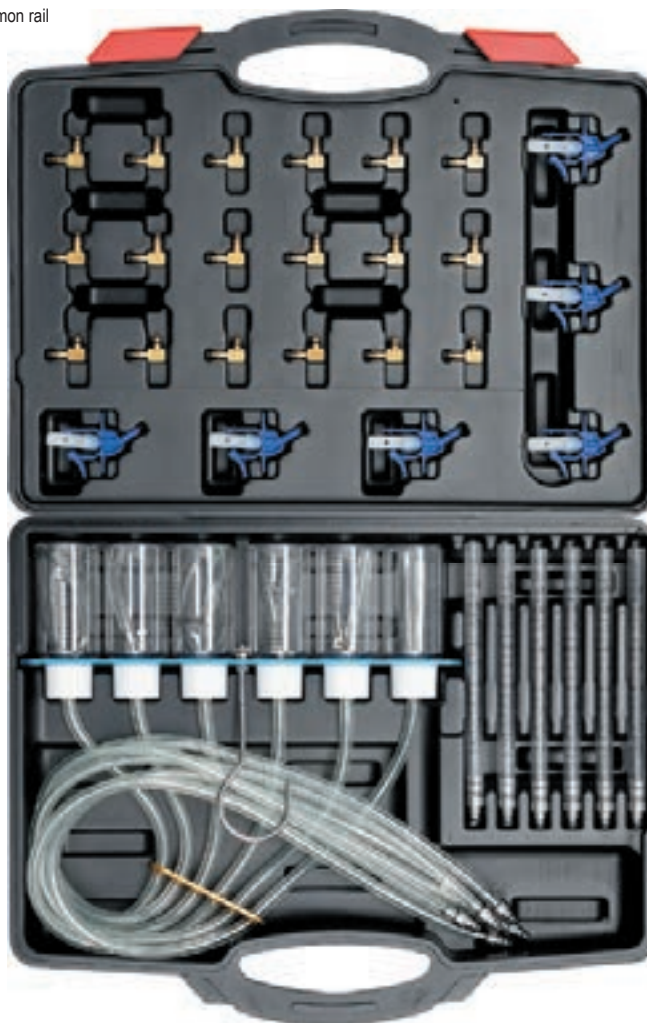

BMC
 & COLOR
 SLEEVE

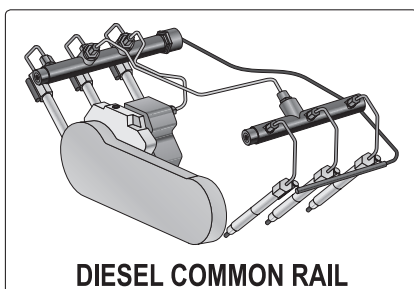

| | | | |
|-------------|---|-------------|--|
| YATO | | YATO | |
| YT-7306 | 5 | | |

GB Combined sockets for alternator
D Werkzeugsatz für Lichtmaschine
PL Zestaw do alternatorów ze sprzęgłem
RUS Набор для альтернатора
CZ Souprava na opravu alternátorů

H Generátor szerszámkészlet
RO Garnitură pt. alternator
E Enchufes combinados para alternador
CN 发动机拆卸组套

13
PCS

1/2"
12.5mm

HEX

TORX

SPLINE

CrV

HRC
40-44

S45C

HRC
38-42

STEEL
8660

HRC
53-57

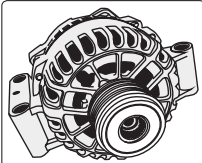

**FOR ALTERNATORS
DO ALTERNATORÓW**

- 1/2" (12.7 mm): M10, HBS, 33T, L=110 mm; CrV; HRC 40-44;
- 1/2" (12.7 mm): T50, HBS, 33T, L=110 mm; CrV; HRC 40-44;
- M8, M10, L=75 mm; 8660; HRC 53-57;
- T40, T50, L=75 mm; 8660; HRC 53-57;
- H8, H10, L=75 mm; 8660; HRC 53-57;

- H15, 33T, L=30 mm; CrV; HRC 40-44;
- H22, 33T, L=30 mm; CrV; HRC 40-44;
- H22, L=30 mm; S45C; HRC 38-42;
- Ø 35 x 30 mm; CrV; HRC 40-44;
- 1/2" (12.7 mm) x 10 mm; CrV; HRC 40-44

BMC
& COLOR
SLEEVE



| | | |
|-------------|----------------|----|
| YATO | ○ | ○ |
| YT-0421 | 1/2" (12.7 mm) | 15 |

GB Combined sockets for alternator
D Werkzeugsatz für Lichtmaschine
PL Zestaw do alternatorów ze sprzęgłem
RUS Набор для альтернатора
CZ Souprava na opravu alternátorů

H Generátor szerszámkészlet
RO Garnitură pt. alternator
E Enchufes combinados para alternador
CN 发动机拆卸组套

22
PCS

1/2"
12.5mm

HEX

TORX

SPLINE

3/8"
10mm

CrV

HRC
40-44

S45C

HRC
38-42

STEEL
8660

HRC
53-57

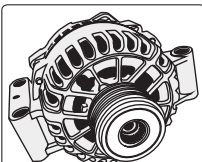
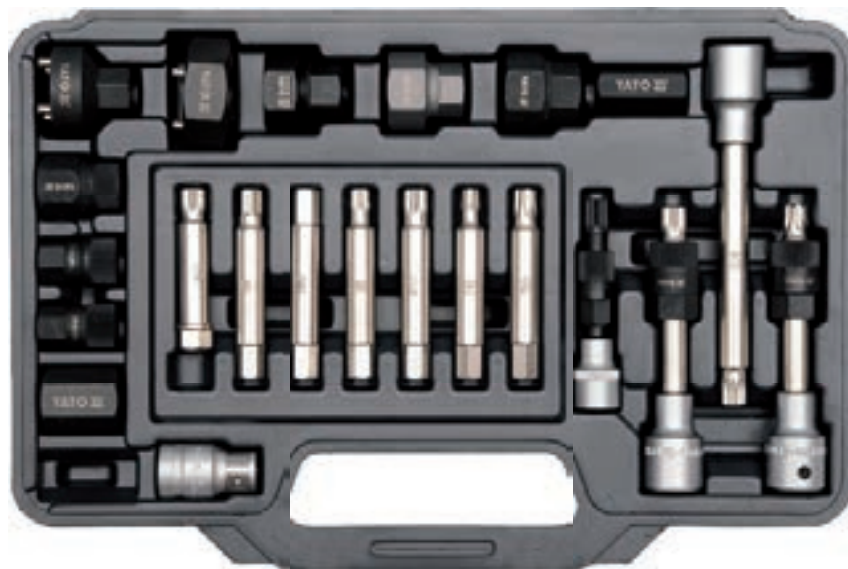

**FOR ALTERNATORS
DO ALTERNATORÓW**

- 1/2" (12.7 mm): M10, HBS, 33T, L=113 mm;
CrV; HRC 40-44 / 8660; HRC 53-57;
- 1/2" (12.7 mm): T50, HBS, 33T, L=113 mm;
CrV; HRC 40-44 / 8660; HRC 53-57;
- 3/8" (10 mm): M10; HBS, 33T; L=80 mm;
CrV; HRC 40-44 / 8660; HRC 53-57;
- 1/2" (12.5 mm): M10; HBS, 33T;
L=140 mm; CrV; HRC 40-44;
- M8, M10, L=75 mm; 8660; HRC 53-57;
- T40, T50, L=75 mm; 8660; HRC 53-57;

- H8, H10, L=75 mm; 8660; HRC 53-57;
- M8xH12, L=64 mm; 8660; HRC 53-57;
- H15, 33T, Ø 17 mm, L=30 mm, H15, 33T, Ø 19 mm, L=30 mm,
H22, 33T, Ø 19 mm, L=30 mm; CrV; HRC 40-44;
- H17, H22, L=30 mm; S45C; HRC 38-42;
- Ø 35 x 30 mm; S45C; HRC 38-42;
- Ø 38 mm; S45C; HRC 38-42;
- H19x28, H21x28, H22x28; S45C; HRC 38-42;
- 1/2" (12.5 mm) (F) x H10 mm (F); CrV; HRC 40-44

BMC
& COLOR
SLEEVE



| | | | |
|-------------|----------------|---------------|---|
| YATO | ○ | ○ | ○ |
| YT-04211 | 1/2" (12.7 mm) | 3/8" (9.5 mm) | 5 |

- GB Stroboscopic tube
- D Stroboskoplampe
- PL Lampa stroboskopowa
- RUS Стробоскопная лампа
- CZ Stroboskopická lampka
- H Stroboszkóp lámpa
- RO Lampă stroboscopică
- E Tubo estroboscópico
- CN 点火正时灯

12V ENGINE SPEED PROTECT-CAPTOR 8000 min⁻¹ max. **XENON**

DOUBLE BLISTER

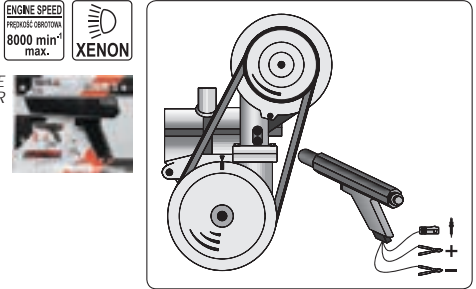

0-60°

| | | | | | |
|-------------|------|-------------|------|-------------|------|
| YATO | | YATO | | YATO | |
| YT-7310 | 6/12 | YT-7311 | 6/12 | YT-7312 | 6/12 |

- GB Universal radiator pressure kit
- D Diagnosekit für Kühler
- PL Zestaw diagnostyczny do chłodnicy
- RUS Диагностический набор к радиатору
- CZ Souprava k diagnostice chladiče
- H Diagnosztikai készlet hűtőkhöz
- RO Ansamblu pt. diagnosticarea radiatorului
- E Juego de herramientas diagnosticas para el radiador
- CN 万用水箱压力测试组套

14 PCS **P max. 0.25 MPa** **200°C max.**

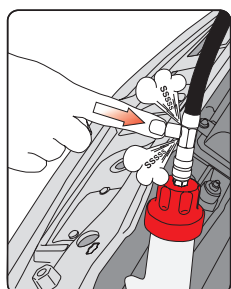
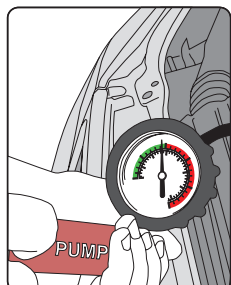
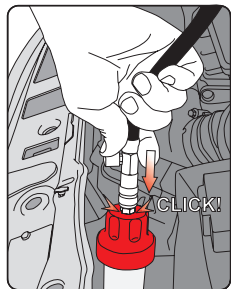

BMC & COLOR SLEEVE

| YATO | No. | | | |
|-------------|-----|--|---|---|
| YT-0672 | 2 | | General Motors | |
| | 3 | | Mercedes, General Motors, Jeep | |
| | 4 | | Peugeot, Subaru, Chrysler, Acura, General Motors, Mitsubishi, Nissan, Mazda, Toyota, Infiniti, GEO, Suzuki, Isuzu, Ford | |
| | 5 | | Honda, Toyota, Suzuki, Mitsubishi, Chrysler, Acura | |
| | 6 | | Audi, BMW, Volkswagen, Porsche | |
| | 7 | | Volvo, Saab, Citroen, Renault, Fiat, Alfa Romeo, Jeep | |
| | 8 | | Volkswagen | 4 |
| | 9 | | Mercedes, General Motors, Jeep | |
| | 10 | | BMW | |
| | 11 | | Audi, Volkswagen | |
| | 12 | | Ford, Land Rover, Opel, Jaguar, Mercedes | |
| | 13 | | Mercedes | |

- GB Hand-held vacuum pump
D Unterdruckpumpe mit Zubehör
PL Pompka podciśnieniowa z akcesoriami
RUS Насос вакуумметрического давления с принадлежностями
CZ Podtlaková pumpa s příslušenstvím
H Vákuum- és ac-pumpa mérő, tartozékokkal
RO Pompa de vidare cu accesorii
E Bomba de subpresión con accesorios
CN 手持式真空泵



16
PCS -1÷0
bar

BMC
& COLOR
SLEEVE



YATO 
YT-0673 10

- GB Hand-held vacuum pump
D Unterdruck-druckpumpe mit Zubehör
PL Pompka ciśnieniowo-podciśnieniowa z akcesoriami
RUS Насос вакуумметрического давления с принадлежностями
CZ Podtlaková-tlaková pumpa s příslušenstvím
H Vákuum- és ac-pumpa mérő, tartozékokkal
RO Pompa de vidare cu accesorii
E Bomba de subpresión-presión con accesorios
CN 手持式真空泵



22
PCS -1÷3
bar

BMC
& COLOR
SLEEVE



YATO 
YT-0674 5

- GB Flexible line clamp
D Schlauchklemmsatz
PL Komplet zacisków do przewodów z cieczą
RUS Набор зажимов с фиксатором
CZ Sada hadicových svěrek
H Flexibilis cső elszorító készlet
RO Clema flexibilă
E Juego de alicates apretadores para conductos de líquidos
CN 油管封口钳组套

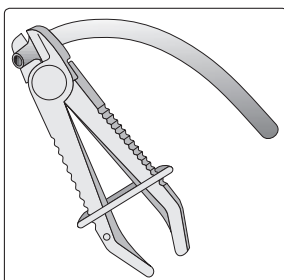

1/4" - 3/4"



1/2" - 5/4"



3/4" - 9/4"



1/4" - 3/4" for brake and fuel lines
6.3 - 19.0 mm do przewodów hamulcowych i paliwowych

1/2" - 5/4" for flexible hose
12.5 - 32.0 mm do przewodów elastycznych

3/4" - 9/4" for radiator hose clamp
19.0 - 57.0 mm do przewodu chłodnicy

3
PCS

WILL NOT
CUT HOSES
NIE NISZCZY
PRZEWODÓW

NON-CONDUCTIVE
NEPRZEWODĄCE

SLIDING
CARD



YATO 
YT-0840 25/50

- GB Spark plug socket
- D Steckschlüssel mit Gummihalterung
- PL Nasadka do świec
- RUS Головка свечная
- CZ Nastavec pro svíčky
- H Gyújtógyertya toldalék
- RO Cheie de bujii
- E Boquilla de bujías
- CN 六角火花塞套筒

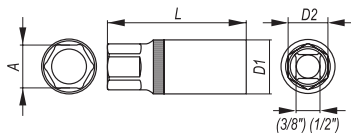

| | | |
|----------|---------------|-----------------|
| | 3/8" 10 mm | 1/2" 12.5 mm |
| AS-DRIVE | DIN 3121 | CrV 50BV30 |

| YATO | Ø | A | D1 (mm) | D2 (mm) | L (mm) | PCS. packing | |
|---------|----------------|------|---------|---------|--------|--------------|--------|
| YT-3851 | 3/8" (9.5 mm) | 16.0 | 22.0 | 19.0 | 64.0 | 10 | 50/100 |
| YT-1253 | 1/2" (12.7 mm) | 16.0 | 22.0 | 19.0 | 64.0 | 10 | 50/100 |
| YT-1254 | 1/2" (12.7 mm) | 21.0 | 27.8 | 24.0 | 64.0 | 10 | 50/100 |

- GB T-type universal joint spark plug socket set
- D Kerzenschlüssel mit Verlängerungshebel
- PL Klucz do świec z przedłużką
- RUS Ключ к свечам с удлинителем
- CZ Klič na svíčky s prodlužovacím nástavcem
- H Gyertyakulcs hosszabbítóval
- RO Cheie cu prelungitor, pt. bujii
- E Llave para las bujías con extensión
- CN T型万用火花塞套筒组套



| | | | |
|----------|--------|----------|------------|
| | 4 PCS | 16 mm | 21 mm |
| AS-DRIVE | 250 mm | CrV 6140 | CrV 50BV30 |

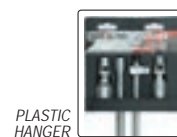

| YATO | |
|---------|-------|
| YT-0815 | 10/20 |

- GB Spark plug socket
- D Kerzenschlüssel mit Verlängerungshebel
- PL Klucz do świec z przedłużką

- RUS Ключ к свечам с удлинителем
- CZ Klič na svíčky s prodlužovacím nástavcem
- H Gyertyakulcs hosszabbítóval

- RO Cheie cu prelungitor, pt. bujii
- E Llave para las bujías con extensión
- CN 火花塞套筒

| | | | |
|-----------------------|------------|--|--|
| 3/8" (10 mm) x 300 mm | CrV 50BV30 | | |
|-----------------------|------------|--|--|

PLASTIC HANGER



| YATO | Ø (mm) | |
|---------|--------|-------|
| YT-0817 | 16 | 10/40 |
| YT-0818 | 18 | 10/40 |
| YT-0819 | 21 | 10/40 |

- GB Bi-hexagonal spark plug socket
- D Zwölfkant-Kerzenschlüssel mit Verlängerungshebel
- PL Klucz do świec dwunastokątny z przedłużką
- RUS Ключ к свечам с удлинителем

- CZ Klič dvanáctihranný na svíčky s prodlužovacím nástavcem
- H Gyertyakulcs hosszabbítóval, 12 lapú
- RO Cheie cu prelungitor, bihexagonala, pt. bujii

- E Llave bihexagonal para las bujías con extensión
- CN 十二角火花塞套筒

| | | | | |
|--|-----------------------|------------|--|--|
| | 3/8" (10 mm) x 300 mm | CrV 50BV30 | | |
|--|-----------------------|------------|--|--|

PLASTIC HANGER



| YATO | Ø (mm) | |
|---------|--------|-------|
| YT-0812 | 14 | 10/40 |

- GB Joined glow plug socket set
- D Schlüsselsatz für Glühkerzen
- PL Zestaw kluczy do świec żarowych
- RUS Набор ключей к калильным свечам
- CZ Sada kličů na žhavicí svíčky
- H Gyertyakulcs készlet
- RO Set chei pt. bujii incandescente
- E Juego de llaves para bujías incandescentes
- CN 预热火花塞套筒组套



| | | |
|-------------------------|------------|----------------------------------|
| 6 PCS | 3/8" 10 mm | BLOCKING SYSTEM SYSTEM BLOKOWACY |
| 8, 9, 10, 12, 14, 16 mm | | |
| CrV 50BV30 | | |

BMC & COLOR SLEEVE



| YATO | Ø | |
|---------|---------------|----|
| YT-0534 | 3/8" (9.5 mm) | 10 |

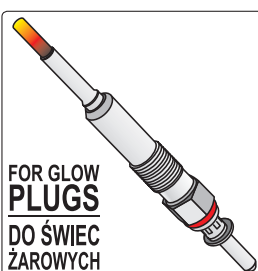

- GB Torque angle gauge
D Winkelmesser zum Anziehen von Schrauben
PL Kałomierz do dokręcania śrub
RUS Угломер для подвёртывания болтов
CZ Úhloměr k utahování šroubů
H Nyomaték szögmérő
RO Raportor pt. înşurubat şuruburi
E Calibrador para apretar tornillos
CN 扭力角度规



SLIDING CARD



1/2"
12.5mm

360°

CrV

| | |
|---|---|
| YATO  |  |
| YT-0593 | 12/48 |

- GB Metal conduit bender
D Biegevorrichtung für Metallleitungen
PL Giętarka do przewodów metalowych
RUS Гибочный станок для проводов из металла
CZ Ohýbačka kovových trubek
- H Hajlító fémvezetékekhez
RO Maşina de îndoit (curbat) pt. cabluri metalice
E Dobladora de tubos de metal
CN 弯管器

SLIDING CARD





Al





125 mm max. ∅ 6 mm 



235 mm max. ∅ 12 mm 

| | | |
|---|--------|---|
| YATO  | L (mm) |  |
| YT-0813 | 125 | 24/96 |

| | | |
|---|--------|---|
| YATO  | L (mm) |  |
| YT-0814 | 235 | 6/48 |

- GB Disc brake pad puller
D Träge Abziehvorrichtung für die Bremsklötze
PL Ściągacz bezwładnościowy do klocków hamulcowych
RUS Инерционный съёмник тормозных колодок
- CZ Pomůcka k vytahování brzdových destiček
H Fékbetét kiszedő
RO Extractor de inerție pt. plăcuțele de frână
E Desmontador de inercia para las zapatas de freno
CN 刹车盘扳手

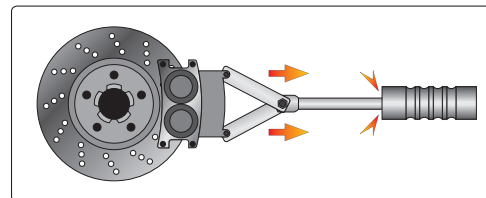

DROP FORGED KUTE

820g

28~128 mm



COLOR BOX

| | |
|---|---|
| YATO  |  |
| YT-2538 | 20 |

- GB Brake retainer spring tool
D Montagewerkzeug für Bremsfeder
PL Ściągacz sprężynek szcęk hamulcowych
RUS Съёмник для тормозных пружин
CZ Stahovač pružin brzdových čelistí
H Fékrugó szerelő szerszám
RO Dispozitiv pt. montat arc pe sabot
E Herramienta para resorte retenedor de frenos
CN 刹车弹簧华司拆装器

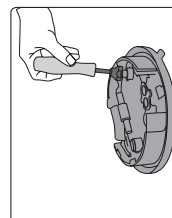

SLIDING CARD



FOR DRUM BRAKES DO HAMULCOW BĘBNOWYCH



| | |
|---|---|
| YATO  |  |
| YT-0685 | 12/96 |

| | |
|---|---|
| YATO  |  |
| YT-0686 | 12/72 |

- GB Brake spring pliers kit
D Bremsbacken-montage set
PL Zestaw do montażu szcęk hamulcowych
RUS Набор инструментов для тормозных пружин
CZ Sada na montáž brzdových čelistí
- H Fogókészlet fékrugóhoz
RO Dispozitiv pt. inlocuit garnituri cilindrii receptori
E Juego para resortes de frenos
CN 刹车拆卸工具组套

3 PCS

FOR DRUM BRAKES DO HAMULCOW BĘBNOWYCH

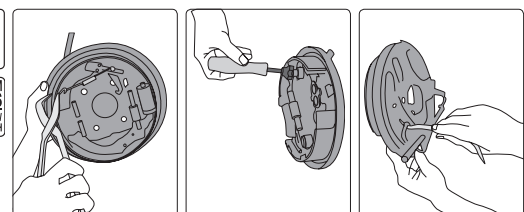

DOUBLE BLISTER



| | |
|---|---|
| YATO  |  |
| YT-0684 | 6/24 |

- GB Professional brake tool set
 D Werkzeugsatz zum Wechseln der Bremsbacken
 PL Zestaw do wymiany szcęk hamulcowych
 RUS Набор для замены тормозных колодок
 CZ Sada na výměnu brzdových čelistí
 H Fékpofa-cserélő készlet
 RO Kit pt. înlocuirea saboților de frână
 E Juego para el reemplazo de zapatas de freno
 CN 刹车拆卸工具组套



8
PCS

FOR DRUM
BRAKES
DO HAMULCOW
BĘGNOWYCH

BMC
& COLOR
SLEEVE

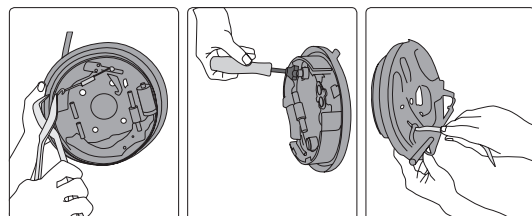

YATO
YT-0680 5

- GB Speedy brake pad compresses
 D Ausdrückvorrichtung für Bremskolben
 PL Wyciskacz do tłoczków hamulcowych
 RUS Приспособление для выдавливания тормозных поршней
 CZ Přípravek k zatlačování brzdových pístů
 H Fék dugattyú visszanyomó
 RO Presă pt. pistoane de frână
 E Expulsor para pistones de frenos
 CN 快速刹车片分离器



15-90
mm

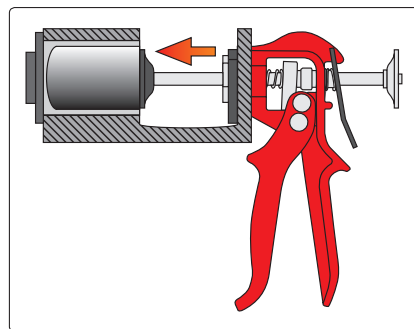

COLOR
BOX

YATO
YT-0604 16

- GB Disc brake spreader
 D Scheibenbremsen Abscheider
 PL Separator do hamulców tarczowych
 RUS Распорка тормозных дисков
 CZ Přípravek na montáž brzdových prasátek
 H Fék munkahenger visszanyomó
 RO Separator disc abreiaj
 E Separador de frenos de discos
 CN 刹车片分离器

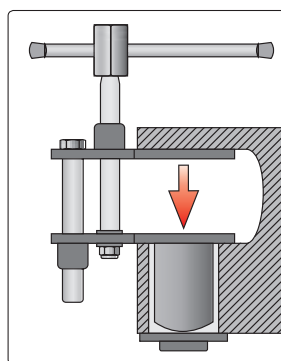

0-65
mm (1/2" (12.5 mm)
21 mm

COLOR BOX

YATO
YT-0610 12/24

- GB Disc brake piston tool
 D Bremskolbenrücksteller universal
 PL Uniwersalny klucz do wkręcania zacisków hamulcowych
 RUS Ключ для тормозного поршня
 CZ Univerzální klíč k montáži brzdových třmenů
 H Féknyereg összenyomó
 RO Dispozitiv pt. împins etrier
 E Llave para comprimir pistones del freno de disco
 CN 刹车分泵拆装器



3/8"
10 mm CrV

SLIDING
CARD

YATO
YT-0683 12/96

for / dla: GM, FORD, Chrysler, VW, Fiat

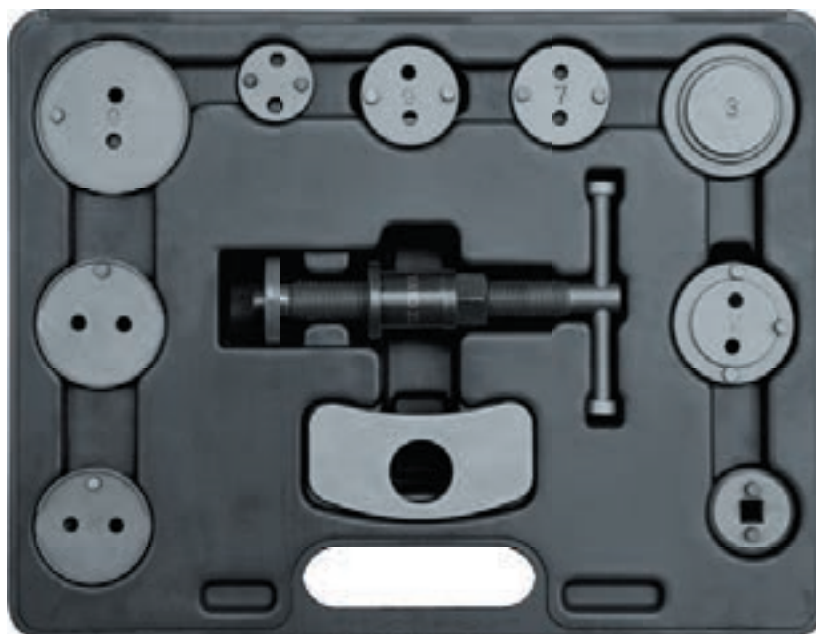

- GB Disc brake pad & caliper service tool kit
D Werkzeugsatz von manuellen Separatoren für die Bremsklappen
PL Zestaw ręcznych separatorów do zacisków hamulcowych
RUS Набор ручных сепараторов для тормозных зажимов
CZ Ruční sada na montáž kotoučových brzd
H Fékmunkahenger prés készlet
RO Set de separatoare manuale pt. etrier frâna
E Juego de separadores manuales para abrazaderas de freno
CN 刹车片分离器组套

11
PCS

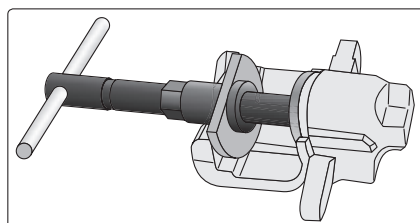

BMC
& COLOR
SLEEVE



| YATO  | No. | zacisk przedni (F) | zacisk tylny (R) |  |
|--|----------------|---|--|---|
| YT-0681 | 1-1 | silownik | | 5 |
| | 1 | plytka oporowa | | |
| | 5 | adapter z gniazdem | | |
| | 2 | Citroen: XM, Xantia | | |
| | 3 | Alfa Romeo, Audi, Austin, BMW, Honda, Jaguar, MB, Mitsubishi, Nissan, Rover, Toyota, VW | | |
| | 4 | | Ford, Mazda, Subaru, Alfa Romeo, Saab | |
| | 6 | | Nissan | |
| | 7 | | Audi, Ford, Honda, Nissan, Rover, Saab, Subaru, VW | |
| | 8 | General Motors | | |
| 9 | General Motors | | | |

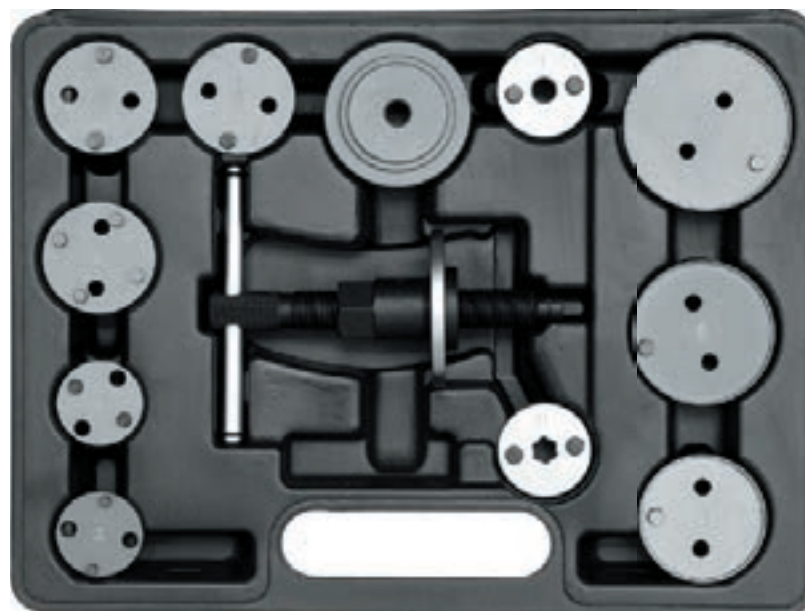

- GB Disc brake pad & caliper service tool kit
D Werkzeugsatz von manuellen Separatoren für die Bremsklappen
PL Zestaw ręcznych separatorów do zacisków hamulcowych
RUS Набор ручных сепараторов для тормозных зажимов
CZ Ruční sada na montáž kotoučových brzd
H Fékmunkahenger prés készlet
RO Set de separatoare manuale pt. etrier frâna
E Juego de separadores manuales para abrazaderas de freno
CN 刹车片分离器组套

12
PCS

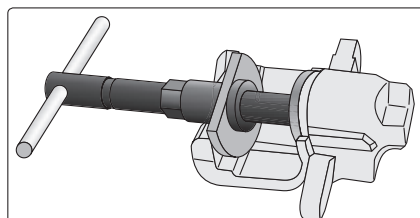

BMC
& COLOR
SLEEVE



| YATO  | No. | zacisk przedni (F) | zacisk tylny (R) |  |
|--|-----|--|--|---|
| YT-0611 | 0 | General Motors - zaciski 2 1/2" (63.5 mm) | | 10 |
| | 1 | Adapter do przedniego zacisku | | |
| | 2 | Citroen XM, Xantia (F/R) | | |
| | 3 | | Opel (R) | |
| | 4 | | Ford (R), Mazda (R), Saab (R), Alfa Romeo 164 2.0 (R), Honda (R), General Motors (R) | |
| | 5 | Nissan Maxima | | |
| | 6 | | Nissan Primera, VW Golf IV | |
| | 7 | Audi (F), Rover, Subaru (F), Ford (F), Nissan (F), Peugeot (F), Toyota (F), VW (F) | | |
| | 8 | General Motors - zaciski 1 7/8" (47.6 mm) | | |
| | 9 | General Motors - zaciski 2 1/8" (54.0 mm) | | |
| | 11 | | Adapter do tylnego zacisku | |

16

- GB Disk brake pad and caliper
- D Pneumatischer Werkzeugsatz für Bremssattelssysteme
- PL Pneumatyczny zestaw do zacisków hamulcowych
- RUS Пневматический набор к тормозным зажимам
- CZ Pneumatická souprava k montáži kotoučových brzd
- H Pneumatikus készlet fék-munkahengerekhez
- RO Ansamblu pneumatic pt. cilindre de frana
- E Juego de herramientas neumaticas para apretadores de frenos
- CN 盘式制动衬块和制动钳

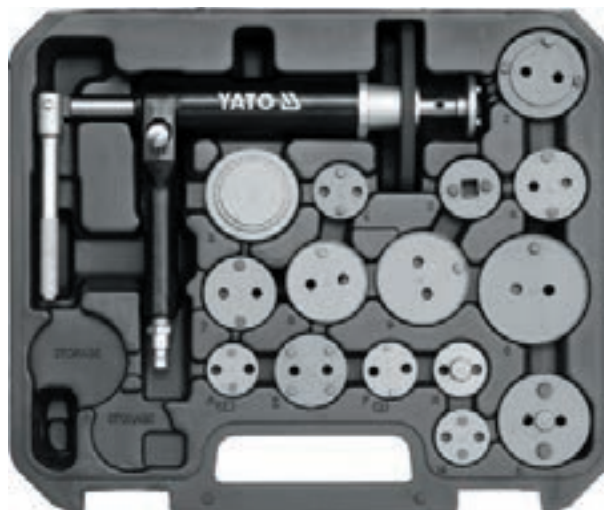
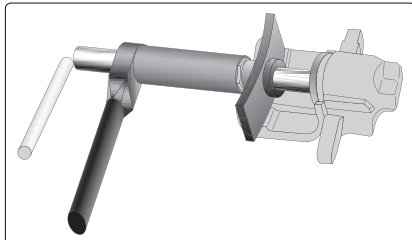

16
PCS

0.75
MPa

1/4"
6.3mm

BMC
& COLOR
SLEEVE



| YATO | No. | zacisk przedni (F) | zacisk tylny (R) | |
|---------|-----|--|--|---|
| | 0 | General Motors - zaciski 2 1/2" (F) (63.5 mm) | | |
| | 2 | | Citroen XM, Xantia (F/R) | |
| | 3 | Audi (F), Alfa Romeo (F), Fiat (F), Ford Fiesta (F), Isuzu (F), Honda Concerto (F), Jaguar (F/R), BMW (F), Mercedes-Benz (F), Mitsubishi Colt (F), Nissan: Almera, Stanza, Sunny (F), Rover (F), Toyota Camry (F), Volvo (F), VW (F) | | |
| | 4 | | Ford (R), Mazda (R), Saab (R), Alfa Romeo 164 2.0 (R), Honda (R), General Motors (R) | |
| | 5 | | Adapter z gniazdem 3/8" | |
| | 6 | | Nissan Primera (R), VW Golf IV (R) | |
| YT-0671 | 7 | | Audi (R), Rover, Subaru (R), Ford (R), Nissan (R), Peugeot (R), Toyota (R), VW (R) | 5 |
| | 8 | General Motors - zaciski 1 7/8" (47.6 mm) | | |
| | 9 | General Motors - zaciski 2 1/8" (54.0 mm) | | |
| | A | | Renault (R) | |
| | E | | Nissan Maxima (F/R) | |
| | F | | Opel (R) | |
| | K | | Citroen (R) | |
| | M | | Ford (R), Cooper (R) | |
| | N | Saab, Honda (F/R) | | |

- GB Disc brake pad & caliper service tool kit
- D Werkzeugsatz von manuellen Separatoren für die Bremsklemmen
- PL Zestaw ręcznych separatorów do zacisków hamulcowych
- RUS Набор ручных сепараторов для тормозных зажимов
- CZ Ruční sada na montáž kotoučových brzd
- H Fékmunkahenger prés készlet
- RO Set de separatoare manuale pt. etrier frâna
- E Juego de separadores manuales para abrazaderas de freno
- CN 刹车片分离器组套

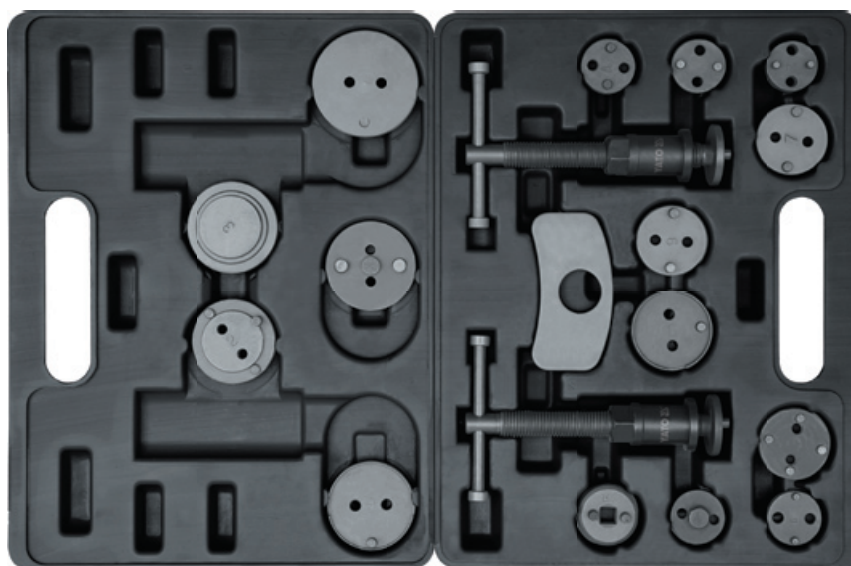
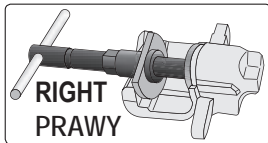
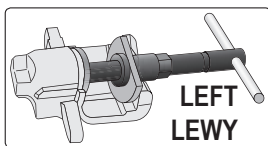

18
PCS

BMC
& COLOR
SLEEVE



| YATO | No. | zacisk tylny (R) | zacisk tylny (R) | |
|---------|-----|--------------------|--|--|
| | 1-1 | | silowniki z lewym i prawym gwintem | |
| | 1 | | plytka oporowa | |
| | 5 | 3/8" (10.0 mm) | adapter z gniazdem | |
| | 0 | 2 1/2" (63.5 mm) | General Motors | |
| | 2 | 2 1/64" (51.0 mm) | Citroen XM, Xantia | |
| | 3 | 2 5/32" (55.0 mm) | Audi, Alfa Romeo, Fiat, Ford Fiesta, Honda, Jaguar, BMW, Mercedes, Mitsubishi Colt, Nissan, Rover, Austin, Toyota Camry, Volvo, VW: Passat, Golf GTI | Jaguar |
| | 4 | 1 1/4" (32.0 mm) | | Ford, Mazda, Saab, Alfa Romeo 164, Honda, General Motors |
| | 6 | 1 21/32" (42.0 mm) | | Nissan Primera, VW Golf IV |
| YT-0682 | 7 | 1 21/32" (42.0 mm) | | Audi, Rover, Subaru, Ford, Nissan, Peugeot, Toyota, VW |
| | 8 | 1 7/8" (48.0 mm) | General Motors | |
| | 9 | 2 1/8" (54.0 mm) | General Motors, Cadillac | |
| | E | 1 21/32" (42.0 mm) | | Nissan Maxima |
| | G | 1 1/4" (32.0 mm) | | Opel |
| | K | 2 1/8" (54.0 mm) | | Citroen |
| | M | 1 1/4" (32.0 mm) | | Ford |
| | N | 1 1/4" (32.0 mm) | Saab, Honda | |
| | Z | 1 3/16" (30.0 mm) | | Renault |

- GB Disc brake pad & caliper service tool kit
D Werkzeugsatz von manuellen Separatoren für die Bremmsklemmen
PL Zestaw ręcznych separatorów do zacisków hamulcowych
RUS Набор ручных сепараторов для тормозных зажимов
CZ Ruční sada na montáž kotoučových brzd
H Fékmunkahenger prés készlet
RO Set de separatoare manuale pt. etrier frâna
E Juego de separadores manuales para abrazaderas de freno
CN 刹车片分离器组套

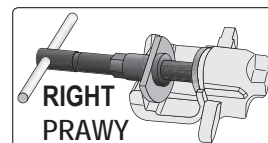
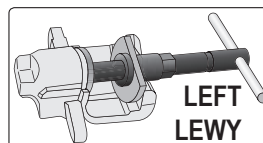

35
PCS

3/8"

10mm

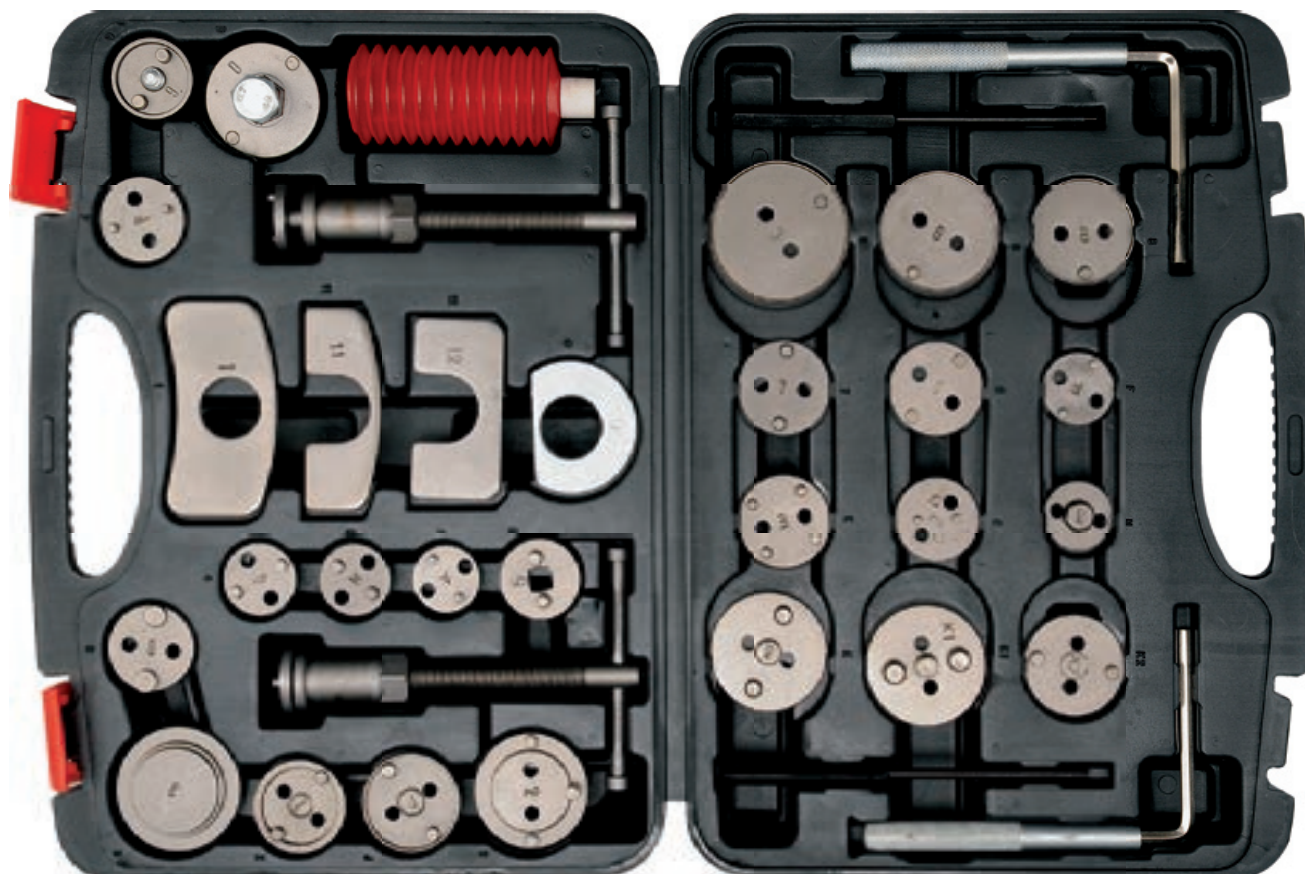

BMC
& COLOR
SLEEVE



| No. | No. | zacisk przedni (F) | zacisk tylny (R) | | |
|----------|-------------------|--------------------|---|--|---|
| YT-06822 | 2 | 2 1/64" (51.0 mm) | Citroen Xantia, Honda Prelude | | |
| | 3 | 2 5/32" (55.0 mm) | Fiat, Alfa Romeo, Isuzu, Mercedes Benz, BMW, Citroen, Ford, Honda, Jaguar, Nissan, Peugeot, Rover, Toyota, VAG, Volvo | Jaguar | |
| | 4 | 1 1/4" (32.0 mm) | Ford, Mazda, Saab, Fiat, Alfa Romeo, General Motors | | |
| | 5 | 3/8" (10.0 mm) | adapter z gniazdem | | |
| | 7 | 1 21/32" (42.0 mm) | Nissan, VAG, Jaguar S | | |
| | 6 | 1 21/32" (42.0 mm) | Audi, Rover, Subaru, Ford, Nissan, Peugeot, Toyota, VAG, Saab, Jaguar, GM | | |
| | 8 | 1 7/8" (48.0 mm) | General Motors | | |
| | 9 | 2 1/8" (54.0 mm) | General Motors, Cadillac | | |
| | 0 | 2 1/2" (63.5 mm) | General Motors | | |
| | A | 1 1/5" (30.5 mm) | | Renault, BMW, Mini | |
| | B | 1 19/30" (41.5 mm) | | Ford, Lincoln, Subaru | |
| | C | 1 19/30" (41.5 mm) | | Mini, Nissan, Opel, Toyota | 5 |
| | D | 2 1/64" (51.0 mm) | Renault, Citroen | | |
| | E | 1 21/32" (42.0 mm) | | Nissan Maxima | |
| | F | 1 1/4" (32.0 mm) | | Opel, Fiat | |
| | G | 3/8" (10.0 mm) | | Peugeot, GM | |
| | J | 1 22/33" (42.5 mm) | Fiat, Alfa Romeo, Audi, Citroen, Renault, Peugeot, Ford, Nissan, Saab, VAG, Subaru, Volvo | | |
| | K | 2 1/8" (54.0 mm) | | Citroen, Opel | |
| | K1 | 2 1/8" (54.0 mm) | Renault, Citroen | | |
| | K2 | 1 22/23" (50.0 mm) | | Citroen, Renault, Audi | |
| | P | 1 19/30" (41.5 mm) | | VAG, BMW, Ford, Lancia, Proton, Renault, Rover, Citroen | |
| | M | 1 1/4" (32.0 mm) | | Ford, Mini, Nissan | |
| | N | 1 1/4" (32.0 mm) | | Saab, Honda, Alfa Romeo, Ford Mondeo, Lancia, Volkswagen | |
| Z | 1 3/16" (30.0 mm) | | Ford, Mazda, Mitsubishi, Toyota Corolla | | |
| | 1, 11, 12 | | plytka oporowa | | |

- GB Coil spring clamp
 D Federspanner
 PL Ściągacz do sprężyn
 RUS Съёмник пружин
 CZ Stahovák pružin tlumičů automobilů
- H Rugóösszehúzó
 RO Presa pt. arcuiri
 E Extractor de muelles
 CN 弹簧夹

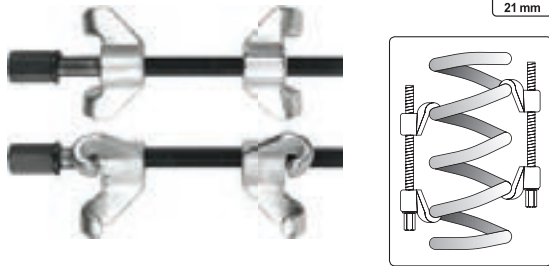

| YATO | Ø (mm) | L (mm) | |
|---------|--------|--------|------|
| YT-0605 | 90 | 200 | 5/10 |



CrV

| YATO | Ø (mm) | L (mm) | |
|---------|--------|--------|---|
| YT-2544 | 82 | 370 | 8 |

GOLD FORGED KUTE NAZIMNO

| YATO | Ø (mm) | L (mm) | |
|---------|--------|--------|---|
| YT-2546 | 82 | 280 | 8 |
| YT-2547 | 82 | 355 | 8 |

- GB Macpherson spring dumper extractor
 D Abziehvorrichtung für Federn von MacPherson
 PL Ściągacz do sprężyn MacPhersona
 RUS Съёмник пружин подвески Макферсона
 CZ Stahovák pružin McPherson
 H MacPerson rugó összehúzó
 RO Extractor de arcuiri MacPherson
 E Desmontador para los resortes de MacPherson
 CN 弹簧压缩器

CrMo SCM-415
 max. 2900kg
 3 POINTS OF FIXING PUNKTY MOCOWANIA

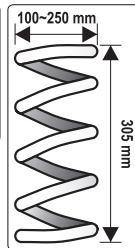

WHITE CARTON BOX & COLOR LABEL

| YATO | |
|---------|---|
| YT-2535 | 2 |

- GB Vice for shock absorber
 D Halterung, Schraubstock für die Säule von MacPherson
 PL Uchwyt, imadło do kolumny MacPhersona
 RUS Тиски к подвеске Макферсона
 CZ Upínací přípravek, svěrák na nápravy McPherson
 H Fogantyú, satu MacPerson oszlophoz
 RO Măner, menghină pt. coloana MacPherson
 E Mandril, torno para la columna de MacPherson
 CN 弹簧避震器固定器

35-70 mm



WHITE CARTON BOX & COLOR LABEL

| YATO | |
|---------|---|
| YT-2537 | 5 |

- GB Interchangeable fork spring compressor and removal tool
 D Abziehvorrichtung für MacPherson-Federn mit austauschbaren Halterungen
 PL Ściągacz do sprężyn MacPhersona z wymiennymi uchwytami
 RUS Стяжка для снятия пружин Макферсона со сменными полукольцами
 CZ Stahovák pružin McPherson s vyměnitelnými čelistmi
 H MacPerson rugó összehúzó cserélhető pófákkal
 RO Ancoră suspensie MacPherson cu măneri interschimbabile
 E Extractor de resortes MacPherson con mangos intercambiables
 CN 免拆式减震弹簧压缩器

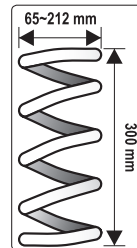

7 PCS
 65-125 mm
 88-160 mm
 max. 1500kg
 126-212 mm

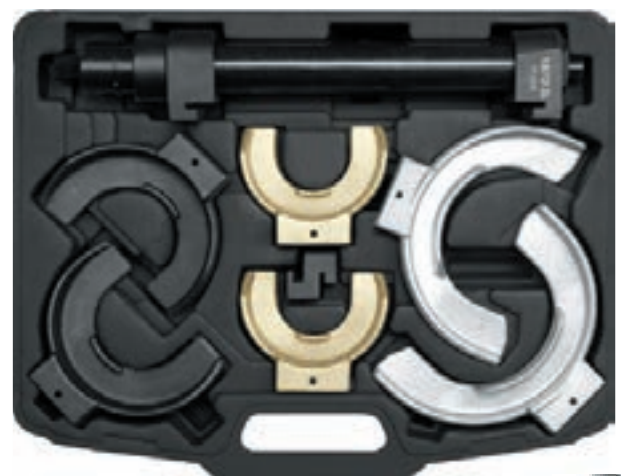

BMC & COLOR SLEEVE

| YATO | |
|---------|---|
| YT-2536 | 1 |

- GB Drive nut set
D Stossdämpfer Nutmutter Einsätze
PL Zestaw nasadek do amortyzatorów
RUS Набор головок для амортизаторов
CZ Sada hlavic na uložení tlumiče
H Lengéscsillapítóköszedő szet
RO Set prezoane
E Juego de boquillas de amortiguadores
CN 拆装减震器套件组套
- No. 1 10.5 mm VW Golf rear
No. 2 12.5 mm VW Golf front
No. 3 14.5 mm VW Polo, Golf, Passat, Audi 80
No. 4 14.5 mm Austin Maestro
No. 5 14.0 mm Mercedes Benz C-Class (W203)

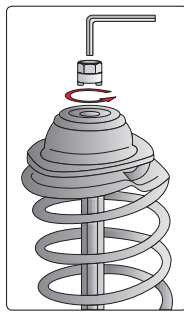

5
PCS

SLIDING
CARD

| YATO | size / rozmiar (mm) | |
|---------|------------------------------|-------|
| YT-0621 | 10.5; 12.5; 14.5; 14.5; 14.0 | 12/48 |

- GB Turnbuckle for shock absorber's top lid
D Schlüsselsatz zum Befestigen der Stoßdämpfer
PL Zestaw kluczy do mocowania amortyzatorów
RUS Набор ключей для крепления амортизаторов
CZ Sada klíčů k montáži tlumičů

- H Kulcskészlet lengéscsillapítók rögzítéséhez
RO Set chei pt. fixare amortizoare
E Juego de llaves para la instalación de amortiguadores
CN 避震器拆卸器

39
PCS

CrMo
SCM415

CrV
6140

CrV
50BV30

STEEL
8660

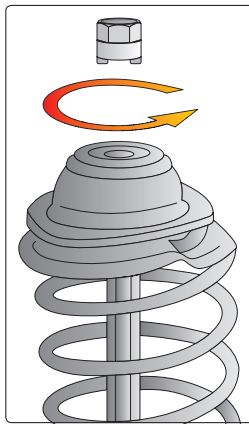

BMC
& COLOR
SLEEVE



| YATO | size / rozmiar (mm) | type of car / model samochodu | size / rozmiar (mm) | type of car / model samochodu | | |
|---------|---------------------|--|---------------------|-------------------------------|---|---------------|
| YT-0628 | 10.5 x 3.5 | VW Golf Rear Axle | CrV 6140 | D5 | Nissan | |
| | 12.5 x 3.5 | VW Golf Front Axle | | D10 | Nissan, Ford | |
| | 14.5 x 5 | VW Polo, Golf, Passat, Audi 80 | | 8 | Mercedes-Benz | |
| | 14.5 x 3 | Austin Maestro | | 9 | Opel/Vauxhall, Chrysler | |
| | 14 x 2.5 | Mercedenz Benz W203 (C-class), W209 (CLK) | CrV 6140 | 10 | Chrysler, Ford | |
| | 14 | Honda, Nissan | | 11 | Japanese Cars | |
| | 16 | VW, Audi, Seat, Fiat | | 5 | Honda | |
| | 17 | Ford, VW, Audi, Seat, Fiat | | 6 | Seat, Fiat, Citroen, Peugeot, Ford, Opel, Renault, Japanese Cars, BMW | |
| | 18 | Ford, VW, Audi, Seat, Rover, Fiat, Opel, Peugeot, Renault, Japanese Cars | | 7 | VW, Audi, Seat, Fiat, Citroen, Peugeot, Mercedes-Benz (W203), Renault | |
| | 19 | VW, Audi, Seat, Citroen, Fiat, Opel, Peugeot, Toyota | STEEL 8660 | 8 | Mercedes-Benz | |
| | 21 | Mercedenz-Benz W203, Chrysler, VW, Audi, Ford, Japanese Cars | | 3 | Mercedes-Benz, Opel, Renault | |
| | 22 | VW, Audi, Seat, Citroen, Fiat, Opel, Peugeot, Renault, BMW | | 3.5 | Chrysler, Ford, Citroen, Peugeot | |
| | 24 | Volvo | | 4 | Citroen, Peugeot | |
| | 27 | VW, Audi, Citroen, Peugeot | | STEEL 8660 | M12 | Opel/Vauxhall |
| | 4 | Nissan | | | T50 | Nissan, Ford |
| | 5.2 | VW, Audi, Nissan | | | | |
| | 6 | VW, Audi, Renault | | | STEEL 8660 | T60 |
| | 6.3 | Nissan | | | | |
| | 7 | VW, Audi, Seat, Fiat | | | | |
| | 8 | Seat, Fiat | | | | |
| 9 | Japanese Cars | | | | | |
| 10 | Seat, Fiat, Volvo | | | | | |
| 12 | Seat, Fiat | | | | | |

- GB Tire valve stem inserter
D Abziehvorrichtung für die Gummiventile
PL Przeciagacz do zaworków gumowych

- RUS Протяжка к резиновым клапанам
CZ Páka k provlékání bezdušových ventilů
H Gumszelep-metsző

- RO Broșă pt. supapele cauciucate
E Brocha de tracción para las válvulas de goma
CN 气门插入工具

290
mm

RUBBER
VALVES
ZAWORY
GUMOWE



SLIDING
CARD

| YATO | L (mm) | |
|---------|--------|-------|
| YT-0619 | 290 | 12/72 |

GB Wheel balance pliers
 D Auswuchtgewicht-Zange
 PL Szczypce do wyważania kół
 RUS Клещи для балансировки колес
 CZ Kleště pro vyvažování kol
 H Centírsúly szerelő szerszám
 RO Cleste pt. cauciuc
 E Tenazas de equilibrar ruedas
 CN 平衡钳

SLIDING CARD

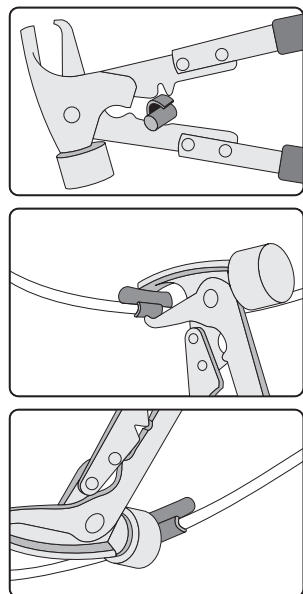

YATO
 YT-0643 12/48

GB Wheel balance pliers with cover
 D Auswuchtgewicht-Zange mit Schutzkappe
 PL Szczypce do wyważania kół z osłoną
 RUS Клещи с защитой для балансировки колес
 CZ Kleště pro vyvažování kol s ochranou
 H Centírsúly szerelő szerszám védőkupakkal
 RO Cleste pt. cauciuc cu protectie
 E Tenazas de equilibrar ruedas, con protector
 CN 平衡钳

SLIDING CARD



PROTECTION HEAD OSŁONA

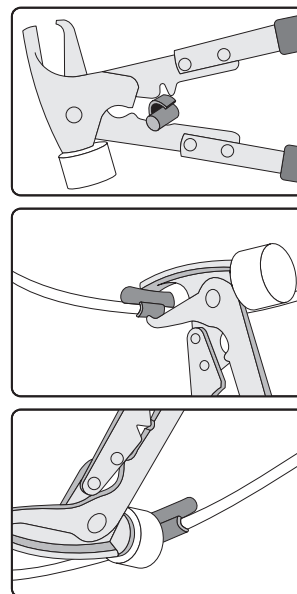

YATO
 YT-0644 6/48

GB Deep thin wall impact sockets
 D Schon-Kraftschraubereinsatz für Alufelgen
 PL Zestaw nasadek udarowych do felg aluminiowych
 RUS Набор головок для алюминиевых дисков
 CZ Sada nástrčných klíčů na alu ráfky
 H Hosszított dugókulcs készlet, könnyűfém felnikhez
 RO Diblu de impact cu mufare in interior
 E Juego de boquillas de percusión para llantas de aluminio
 CN 风动薄壁长套筒

- for service station and tire workshops
- for maximum impact loads
- drive locks
- ultra thin walls and nylon cover for working with alu rims
- anodised colour finish for fast identification of size

- dla serwisów i warsztatów oponiarskich
- do największych obciążeń udarowych i tętniących
- zamki blokujące
- ultra cienkie ścianki i nylonowe pokrycie do pracy z felgami aluminiowymi
- anodowane kolorowe wykończenie dla szybkiej identyfikacji rozmiaru



3 PCS
 1/2" 12.5mm
 17 19 21 mm
 CrMo SCM-440
 26 29 31 mm
 AS-DRIVE



BMC & COLOR BOX

YATO
 YT-1056 1/2" (12.7 mm) 12/24

GB Rubber valve core torque tool
 D Drehmomentwerkzeug für gummi
 Dichtende Reifenventileinsätze
 PL Klucz dynamometryczny do zaworków gumowych
 RUS Ключ динамометрический для резиновых клапанов
 CZ Klíč momentový k montáži gumových ventilků
 H Szeleptűkiszserelő kulcs gumitömítésű szelephöz
 RO Surubelnita din plastic pt. supapa
 E Llave dinamométrica de válvulas de goma
 CN 定扭橡胶气门芯拆卸工具

SLIDING CARD

0.25 Nm

RUBBER VALVES ZAWORY GUMOWE

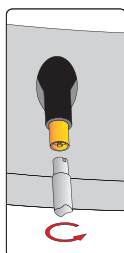

YATO
 YT-0795 50/200

GB Metal valve core torque tool
 D Drehmomentwerkzeug für metallisch
 Dichtende Reifenventileinsätze
 PL Klucz dynamometryczny do zaworków metalowych
 RUS Ключ динамометрический для металлических клапанов
 CZ Klíč momentový k montáži kovových ventilků
 H Szeleptűkiszserelő kulcs fémtömítésű szelephöz
 RO Surubelnita metalica pt. supapa
 E Llave dinamométrica de válvulas de metal
 CN 定扭橡胶气门芯拆卸工具

SLIDING CARD

0.45 Nm

METAL VALVES ZAWORY METALOWE

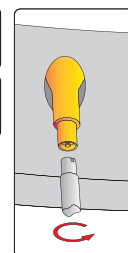

YATO
 YT-0796 50/200

GB Cross rim wrench
D Kreuzschlüssel
PL Krzyżakowy klucz do kół
RUS Ключ-крест балонный
CZ Klíč na kola křížový
H Kereszt kerékkulcs
RO Cheie în cruce pt. roți
E Llave cruz para ruedas
CN 十字套筒扳手



CrV



PLASTIC HANGER

| YATO | size / rozmiar | |
|---------|-------------------------------|----|
| YT-0800 | 17 x 19 x 21 x 22 mm | 10 |
| YT-0801 | 17 x 19 x 21 x 1/2" (12.7 mm) | 10 |
| YT-0802 | 24 x 27 x 32 x 3/4" (19.0 mm) | 3 |

GB T-type sleeved ratchet wrench
D Radmutter Schlüssel für Autos
PL Klucz do kół samochodowych

RUS Ключ к автомобильным колесам
CZ Klíč na kola automobilů
H Kerékkulcs

RO Cheie pt. roți de automobile
E Llave para las ruedas de automóviles
CN T型棘轮扳手组套

4 PCS
1/2"
12.5mm
44T
CrV
50BV30
AS-DRIVE



PLASTIC HANGER

| YATO | size / rozmiar | |
|---------|-----------------------------------|------|
| YT-0803 | 1/2" (12.7 mm): 17, 19, 21, 23 mm | 5/10 |

GB Wrecking bar
D Reifenmontierhebel
PL Łyżka do opon
RUS Прибор для шиномонтажа

CZ Montážní páka na pneumatiky
H Gumiabroncs kar
RO Levier pt. roți

E Desmontable para las llantas
CN 轮胎起子

300 mm 400 mm 500 mm 600 mm CrV



| YATO | size / rozmiar (mm) | |
|---------|---------------------|------|
| YT-0807 | 300 | 20 |
| YT-0808 | 400 | 20 |
| YT-0809 | 500 | 5/20 |
| YT-0810 | 600 | 5/20 |

GB Tire level
D Reifenmontierhebel
PL Łyżka do opon

RUS Прибор для шиномонтажа
CZ Montážní páka na pneumatiky
H Gumiabroncs kar

RO Levier pt. roți
E Desmontable para las llantas
CN 撬棒

SLIDING CARD

380 mm CrMo



| YATO | size / rozmiar (mm) | |
|---------|---------------------|-------|
| YT-0811 | 380 | 10/50 |

GB Extra long flexi shaft ratchet
D Ratsche auf biegsamer Welle
PL Elastyczny walek z grzechotką
RUS Вороток к головке с трещоткой
CZ Ráčna s flexibilní rukojetí

H Racsnis szár flexibilis hajtással
RO Prelungitor flexibil pt. bormasina cu clichet
E Árbol flexible con carraca
CN 加长定扭棘轮扳手

HALF DOUBLE BLISTER

3/8" 10mm 400 mm 31 Nm

41T
1/4" (6.3 mm)



| YATO | size / rozmiar | |
|---------|------------------------|-------|
| YT-0726 | 3/8" 10mm 400 mm 31 Nm | 10/40 |

GB Rectangular telescopic inspection mirror
 D Teleskop Inspektionsspiegel
 PL Lusterko inspekcyjna

RUS Зеркало инспекционное телескопическое
 CZ Zrcátko kontrolní teleskopické
 H Vizsgáló tükör, teleszkópos nyéllel

RO Oglinda telescopică pt. inspecție
 E Espejo rectangular telescópico de inspección
 CN 可伸缩矩形检测镜

50x90 mm
 TELESCOPIC HANDLE
 285x770 mm



YATO
 YT-0660 12/144

GB LED lighted telescopic inspection mirror
 D Prüfspiegel mit Beleuchtung
 PL Lusterko inspekcyjna z lampką

RUS Зеркало досмотровое с подсветкой
 CZ Inspekční zrcadélko s lampou
 H Vizsgáló tükör, lámpával

RO Oglindă pt. inspecție cu lampă
 E Espejo de control con lámpara
 CN 带灯检测镜

285 - 320 mm, Ø54 mm
 TELESCOPIC HANDLE
 TELESKOPOWY UCHWYT

LED

STAINLESS STEEL
 STAL
 NERZŻEWA



YATO
 YT-0663 10/100

GB Inspection camera
 D Inspektionskamera
 PL Kamera inspekcyjna
 RUS Контрольная камера
 CZ Inspekční kamera
 H Felügyelő kamera
 RO Camera de inspecție
 E Cámara de inspección
 CN 手持式电子可视检查仪

BMC & COLOR SLEEVE



900 mm

60°

12.2 mm

LED CAMERA LIGHTING
 OSWIELENIE KAMERA LED

9V (LR6-F)
 BATTERY
 BATERIA



KOLOROWY EKRAŃ LCD

YATO LCD TFT
 YT-7291 2.4" (61 mm) 4



LCD COLOR SCREEN



KOLOROWY EKRAŃ LCD

YATO LCD TFT
 YT-7290 3.5" (89 mm) 4

GB Inspection camera
D Inspektionskamera
PL Kamera inspekcyjna

RUS Контрольная камера
CZ Inspekční kamera
H Felügyelő kamera

RO Cameră de inspecție
E Cámara de inspección
CN 手持式电子可视检测仪

BMC & COLOR SLEEVE

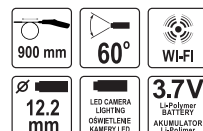

| | | |
|-------------|--------------|---|
| YATO | LCD TFT | |
| YT-7292 | 3.5" (89 mm) | 4 |



| | | |
|-------------|--------------|---|
| YATO | LCD TFT | |
| YT-7293 | 3.5" (89 mm) | 4 |



| | |
|-------------|---|
| YATO | |
| YT-7294 | 4 |

GB Camera with cable
D Kamera mit der Leitung
PL Kamera z przewodem
RUS Камера с проводом
CZ Kamera s kabelem
H Kamera a vezetékkel

RO Cameră de cablul
E Cámara con el cable
CN 电子可视检测仪

for / dla: YT-7290, YT-7291, YT-7292, YT-7293, YT-7294

COLOR BOX



∅ 5.5mm 1m



∅ 9.0mm 1m



| | |
|-------------|----|
| YATO | |
| YT-7295 | 10 |

| | |
|-------------|----|
| YATO | |
| YT-7296 | 10 |

∅ 12.2mm 2m



∅ 12.2mm 1m



| | |
|-------------|----|
| YATO | |
| YT-7297 | 10 |

| | |
|-------------|----|
| YATO | |
| YT-7298 | 10 |

GB Telescopic magnetic pick up tool
D Teleskop magnet Heber
PL Chwytyk teleskopowy z magnesem
RUS Захват магнитный телескопический

CZ Patka teleskopická magnetická
H Felszedő mágnes, teleszkópos nyéllel
RO Telescop magnetic

E Herramienta levantadora magnética, telescópica
CN 可伸缩磁性捡拾器

2 kg
MAGNETIC
TELESCOPIC HANDLE 250x750 mm



YATO
YT-0661 12/144

GB Telescopic magnetic pick up tool
D Teleskop magnet Heber
PL Chwytyk teleskopowy z magnesem
RUS Захват магнитный телескопический

CZ Patka teleskopická magnetická
H Felszedő mágnes, teleszkópos nyéllel
RO Telescop magnetic

E Herramienta levantadora magnética, telescópica
CN 可伸缩磁性捡拾器

MAGNETIC
190 - 800mm TELESCOPIC HANDLE
TELESKOPOWY UCHWYT
LED



YATO
YT-0661 12/144

GB Telescopic magnetic pick up tool
D Teleskop magnet Heber
PL Chwytyk teleskopowy z magnesem
RUS Захват магнитный телескопический
CZ Patka teleskopická magnetická
H Felszedő mágnes, teleszkópos nyéllel
RO Telescop magnetic
E Herramienta levantadora magnética, telescópica
CN 可伸缩磁性捡拾器

GB Magnetic sweeper
D Magnetkehrer
PL Magnetyczna listwa zbierająca
RUS Магнитный сборник металлических предметов
CZ Magnetická metla
H Mágneses gyűjtőléc
RO Colector magnetic
E Recogedor magnético
CN 磁性捡拾器



22.5 kg 82 mm
TELESCOPIC HANDLE UCHWYT TELESKOPOWY 59~99 cm

YATO L (mm) 6/24
YT-0860 59-99



5.5 kg 41x7 cm
TELESCOPIC HANDLE UCHWYT TELESKOPOWY 59~99 cm

YATO L (mm) 6/12
YT-0861 59-99

GB Telescopic pick up and mirror set
D Inspektionssatz: Spiegel + Greifer
PL Zestaw inspekcyjny: lusterko + chwytyk
RUS Проверочный набор - держатель и зеркальце
CZ Inspekční souprava: zrcadlo + držák

H Teleszkópos ellenőrző készlet: tükör + felvevő
RO Garnitură de control: oglindă + benă
E Juego de inspección: espejo + cuchara de mordazas
CN 检测镜、捡拾器套装

4 PCS
0.5 kg (max) 1.5 kg (max)
160 - 620 mm TELESCOPIC HANDLE UCHWYT TELESKOPOWY
MAGNETIC
250 - 930 mm, Ø 57 mm TELESCOPIC HANDLE UCHWYT TELESKOPOWY

PLASTIC BOX & DOUBLE BLISTER



YATO
YT-0662 10/40

GB Magnetic parts tray
D Magnetschale
PL Miska magnetyczna
RUS Магнитный поднос
CZ Miska magnetická

H Mágneses tálca
RO Tava magnetica
E Bandeja de accesorios magnética
CN 磁盘



Ø mm 110

YATO
YT-08295 12/48



Ø mm 150

YATO
YT-0830 12/48

GB Magnetic parts tray
D Magnetschale
PL Miska magnetyczna
RUS Магнитный поднос
CZ Miska magnetická
H Mágneses tálca
RO Tava magnetica
E Bandeja de accesorios magnética
CN 磁盘



0.10-0.12
T
(TESLA)

Ø mm
150



COLOR
BOX



| | |
|-------------|----|
| YATO | |
| YT-08305 | 20 |

GB Magnetic parts tray
D Magnetschale
PL Miska magnetyczna
RUS Магнитный поднос
CZ Miska magnetická
H Mágneses tálca
RO Tava magnetica
E Bandeja de accesorios magnética
CN 磁盘



COLOR BOX



350x150
mm



| | |
|-------------|------|
| YATO | |
| YT-0831 | 6/12 |

GB Magnetic tool holder
D Magnet Werkzeughalter
PL Listwa magnetyczna
RUS Магнитная рейка

CZ Magnetický držák nářadí
H Mágneses tartó
RO Suport magnetic

E Bandeja de accesorios magnética
CN 磁性工具架



SLIDING
CARD

| | |
|-------------|------|
| YATO | |
| YT-0835 | 4/16 |

GB Tweezer
D Pinzette
PL Peşeta

RUS Пинцет
CZ Pinzeta
H Csipesz

RO Pensetă
E Pinzas
CN 镊子



140
mm

HRC
30

SLIDING
CARD



302
STAINLESS
STEEL
STAL
NIERDZEWNA

ANTI
MAGNETIC
ANTYMAG-
NETYCZNA

ANTIACID
KWAŚCO-
ODPORNA

| | | |
|-------------|--------|--------|
| YATO | L (mm) | |
| YT-6903 | 140 | 20/480 |



115
mm

HRC
30

| | | |
|-------------|--------|--------|
| YATO | L (mm) | |
| YT-6907 | 115 | 20/480 |



140
mm

HRC
40

| | | |
|-------------|--------|--------|
| YATO | L (mm) | |
| YT-6916 | 140 | 20/480 |

GB Workshop creeper
D Werkstatt-Liege
PL Leżanka warsztatowa
RUS Лежак ремонтный
CZ Lehátko
H Fekpad gurulos
RO Targa
E Camilla de taller
CN 汽修躺板



100
cm



WHITE
CARTON BOX
& COLOR LABEL



| | |
|-------------|---|
| YATO | |
| YT-0880 | 1 |

GB Rechargeable work lamp
 D Led Werkstattlampe
 PL Diodowa lampa bezprzewodowa
 RUS Светодиодная беспроводная лампа
 CZ Montážní lampa diodová bezpřívodová
 H Ledlámpa
 RO Lampă cu led fara cablu
 E Lámpara inalámbrica de diodos
 CN 可充电工作灯

| | |
|---|------------------------------------|
| 230V~50Hz BATTERY CHARGER ŁADOWARKA | 30 LED |
| 4.8V 3300mAh NIMH | 8-10 h |
| BATTERY CHARGER ŁADOWARKA | SHOCK PROOF ODPORNA NA WSTRZĄSY |
| OIL PROOF ODPORNA NA OLEJ | WATER PROOF ODPORNA NA WODĘ |



GB Rechargeable work lamp
 D Led Werkstattlampe
 PL Diodowa lampa bezprzewodowa
 RUS Светодиодная беспроводная лампа
 CZ Montážní lampa diodová bezpřívodová
 H Ledlámpa
 RO Lampă cu led fara cablu
 E Lámpara inalámbrica de diodos
 CN 可充电工作灯

| | |
|------------------------------------|---|
| 21+5 LED | 3 POSITION POZYCJE |
| 3.6V 1800mAh NIMH | 230V~50Hz BATTERY CHARGER ŁADOWARKA |
| 21 LED 4-5h | 5 LED 10h |
| WATER PROOF ODPORNA NA WODĘ | OVERLOAD PROTECTION ZABEZPIECZENIE PRZEŁADOWANA |
| SHOCK PROOF ODPORNA NA WSTRZĄSY | OIL PROOF ODPORNA NA OLEJ |
| | SHORTAGE PROTECTION ZABEZPIECZENIE PRZEDNADCIĄGIEM |



MAGNETIC

COLOR BOX



GB Rechargeable work lamp
 D Led Werkstattlampe
 PL Diodowa lampa warsztatowa
 RUS Светодиодная беспроводная лампа
 CZ Montážní lampa diodová bezpřívodová
 H Ledlámpa
 RO Lampă cu led fara cablu
 E Lámpara inalámbrica de diodos
 CN 可充电工作灯

| | |
|--------------------------------|---|
| 27 LED | 13000 MCD |
| 3.6V 1200mAh NI-MH | 230V~50Hz BATTERY CHARGER ŁADOWARKA |
| 4 h | CHARGING TIME CZAS ŁADOWANIA 4 h |
| WATER PROOF ODPORNA NA WODĘ | MAGNETIC |



DOUBLE BLISTER



YATO
YT-0850

3/6

YATO
YT-0851

20

YATO
YT-08523

10

GB Rechargeable work lamp
D Led Werkstattlampe
PL Diodowa lampa warsztatowa
RUS Светодиодная беспроводная лампа
CZ Montážní lampa diodová bezpřívodová
H Ledlampa
RO Lampa cu led fara cablu
E Lámpara inalámbrica de diodos
CN 可充电工作灯

30/7 LED **13000 MCD**
3.6V 1200mAh NI-MH **230V~50Hz BATTERY CHARGER LADOVARKA**
15 h (7 LED) 4 h (30 LED)
CHARGING TIME CZAS ŁADOWANIA 4-5 h

GB Rechargeable work lamp
D Led Werkstattlampe
PL Diodowa lampa warsztatowa
RUS Светодиодная беспроводная лампа
CZ Montážní lampa diodová bezpřívodová
H Ledlampa
RO Lampa cu led fara cablu
E Lámpara inalámbrica de diodos
CN 可充电伸缩工作灯

30/6 LED **13000 MCD**
3.6V 1000mAh NI-MH **230V~50Hz BATTERY CHARGER LADOVARKA**
10 h (6 LED) 3 h (30 LED)
CHARGING TIME CZAS ŁADOWANIA 3-4 h

GB Rechargeable work lamp
D Led Werkstattlampe
PL Diodowa lampa warsztatowa
RUS Светодиодная беспроводная лампа
CZ Montážní lampa diodová bezpřívodová
H Ledlampa
RO Lampa cu led fara cablu
E Lámpara inalámbrica de diodos
CN 可充电工作灯

60+1 LED **13000 MCD**
7.2V 800mAh NI-MH **230V~50Hz BATTERY CHARGER LADOVARKA**
4 h WATER PROOF ODPORNÁ NA VODĚ



COLOR BOX

YATO
YT-08505 10



COLOR BOX

YATO
YT-08512 12



DOUBLE BLISTER

YATO
YT-0852 5/20

GB Under bonnet work led lamp
D Led Werkstattlampe
PL Diodowa lampa warsztatowa do oświetlenia komory silnika
RUS Светодиодная беспроводная лампа
CZ Montážní lampa diodová bezpřívodová
H Ledlampa
RO Lampa cu led fara cablu
E Lámpara inalámbrica de diodos
CN 引擎盖检修灯



120 LED **13000 MCD**
7.2V 1800mAh NI-MH **230V~50Hz BATTERY CHARGER LADOVARKA**
60 LED **120 LED**
8 h (60 LED) 4 h (120 LED)
CHARGING TIME CZAS ŁADOWANIA 4-5 h

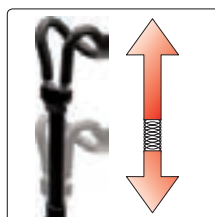
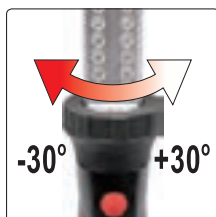

YATO
YT-08530 4

COLOR BOX

GB Automotive circuit tester
 D KFZ Prüflampe
 PL Wskaźnik elektryczny samochodowy
 RUS Пробник напряжения автомобильный
 CZ Zkoušečka napětí autoelektrikářská

H Próbálampa
 RO Tester pt. circuite auto
 E Indicador eléctrico de coche
 CN 汽车测电笔



CABLE KABEL
 90 cm **LED**



6-24 V

6-12 V

| | |
|-------------|--------|
| YATO | |
| YT-2865 | 10/250 |

| | |
|-------------|--------|
| YATO | |
| YT-2866 | 10/100 |

GB Number stamp
 D Nummernstempel
 PL Znaczniki cyfrowe
 RUS Клейма цифровые
 CZ Razidla číselná
 H Számbeütők
 RO Poansoane cu cifre
 E Marcadores de números
 CN 数字冲模

9 PCS
 NUMBERS NUMERY 0 - 9
 1045 CARBON STEEL
 HRC 50-55



PLASTIC BOX & COLOR SLEEVE

| YATO | No (mm) | PCS packing: | |
|-------------|---------|--------------|----|
| YT-6854 | 6 | 9 | 20 |
| YT-6855 | 8 | 9 | 18 |

GB Letter stamp
 D Buchstabenstempel
 PL Znaczniki literowe
 RUS Клейма буквенные
 CZ Razidla písmenová
 H Betűbetűtők
 RO Poansoane cu litere
 E Marcadores de letras
 CN 字母冲模

27 PCS
 LETTERS LITERY A - Z | &
 1045 CARBON STEEL
 HRC 50-55



PLASTIC BOX & COLOR SLEEVE

| YATO | No (mm) | PCS packing: | |
|-------------|---------|--------------|----|
| YT-6862 | 6 | 27 | 12 |
| YT-6863 | 8 | 27 | 8 |

GB Thread repair set
 D Reparatursatz für Gewinde
 PL Zestaw do naprawy gwintów
 RUS Набор для ремонта резьбы
 CZ Souprava na opravu závitů
 H Menetjavító készlet
 RO Set pt. reparare filete
 E Juego para reparar roscas
 CN 螺纹修复套装



METAL BOX & COLOR BOX

HSS 4341
 STAINLESS STEEL STAL NERDZEWNA

88 PCS

| YATO | size / rozmiar | |
|-------------|---------------------|------|
| YT-1769 | M6 x 1.0 x 10.8 mm | 5/10 |
| | M8 x 1.25 x 10.8 mm | |
| | M10 x 1.5 x 13.5 mm | |



131 PCS

| YATO | size / rozmiar | |
|-------------|----------------------|------|
| YT-1763 | M5 x 0.8 x 6.7 mm | 5/10 |
| | M6 x 1.0 x 10.8 mm | |
| | M8 x 1.25 x 10.8 mm | |
| | M10 x 1.5 x 13.5 mm | |
| YT-1763 | M12 x 1.75 x 16.3 mm | |

GB Wire threads
 D Spiraleinlagen für Gewindereparatur
 PL Wkłady spiralne do naprawy gwintów
 RUS Метчики и сверла для ремонта резьбы
 CZ Spirálové vložky na opravu závitů

H Menetjavító betétek
 RO Insertii spirală pt. reparare filete
 E Elementos espirales para reparar roscas
 CN 不锈钢螺纹套

POLYBAG WITH HEADER



for / dla: YT-1763, YT-1769

STAINLESS STEEL STAL NERDZEWNA



| YATO | size / rozmiar | PCS packing: | |
|-------------|----------------------|--------------|--------|
| YT-1764 | M5 x 0.8 x 6.7 mm | 20 | 50/250 |
| YT-1765 | M6 x 1.0 x 10.8 mm | 20 | 50/250 |
| YT-1766 | M8 x 1.25 x 10.8 mm | 20 | 50/200 |
| YT-1767 | M10 x 1.5 x 13.5 mm | 15 | 25/100 |
| YT-1768 | M12 x 1.75 x 16.3 mm | 10 | 25/100 |

GB Foot pump with gauge
D Fusspumpe
PL Pompka nożna z manometrem
RUS Насос ножный с манометром
CZ Nožní pumpa z manometrem

H Lábpumpa nyomásmérővel
RO Pompă de picior cu manometru
E Bomba de pierna con manometro
CN 打气筒



COLOR BOX



YATO 

YT-7349



10

GB Foot pump with gauge
D Fusspumpe
PL Pompka nożna dwutłokowa z manometrem
RUS Насос ножный с манометром
CZ Nožní pumpa z manometrem
H Lábpumpa nyomásmérővel
RO Pompă de picior cu manometru
E Bomba de pierna con manometro
CN 带压力表双管打气筒



TWIN PISTON
PODWÓJNY TŁOK



COLOR BOX



YATO 

YT-7350



10

GB Hand pump with manometer
D Hand-Luftpumpe mit Manometer
PL Pompka słupkowa z manometrem
RUS Насос ручной с манометром
CZ Pumpa z manometrem
H Kézi pumpa manométerrel
RO Pompă de mana cu manometru
E Bomba de barrote con manometro
CN 带压力表打气筒



PLASTIC HANGER
& TAG CARD



YATO 

YT-7352



6

GB Funnel
D Trichter
PL Lejek
RUS Воронка гибкая
CZ Nálevka
H Kétrészes tölcser
RO Pálnie
E Embudo
CN 漏斗



∅
135mm
PP

| | | |
|-------------|--------|-----|
| YATO | ∅ (mm) | |
| YT-0694 | 135 | 192 |

GB Long funnel
D Trichter
PL Lejek dlugi
RUS Воронка гибкая
CZ Nálevka
H Kétrészes tölcser
RO Pálnie
E Embudo
CN 漏斗



∅
120mm
PP

| | | | |
|-------------|--------|--------|----|
| YATO | L (mm) | ∅ (mm) | |
| YT-0693 | 455 | 120 | 48 |

GB Operating fluids funnel
D Trichter
PL Lejek do płynów eksploatacyjnych
RUS Воронка гибкая
CZ Nálevka
H Kétrészes tölcser
RO Pálnie
E Embudo
CN 漏斗



∅
100mm
PP

| | | |
|-------------|--------|-----|
| YATO | ∅ (mm) | |
| YT-0695 | 100 | 180 |

GB Operating fluids funnel
D Trichter
PL Lejek do płynów eksploatacyjnych
RUS Воронка гибкая
CZ Nálevka
H Kétrészes tölcser
RO Pálnie
E Embudo
CN 漏斗



∅
240mm
PP

| | | |
|-------------|--------|----|
| YATO | ∅ (mm) | |
| YT-0696 | 240 | 48 |

GB Fuel and oil funnel
D Trichter
PL Lejek do paliwa i oleju eksploatacyjnych
RUS Воронка гибкая
CZ Nálevka
H Kétrészes tölcser
RO Pálnie
E Embudo
CN 漏斗



∅
150mm
PP

| | | |
|-------------|--------|----|
| YATO | ∅ (mm) | |
| YT-0692 | 150 | 30 |

GB Oil funnel
D Trichter
PL Lejek do oleju
RUS Воронка гибкая
CZ Nálevka
H Kétrészes tölcser
RO Pálnie
E Embudo
CN 漏斗



∅
280mm
PP

| | | |
|-------------|--------|----|
| YATO | ∅ (mm) | |
| YT-0697 | 280 | 48 |

GB Oil drain pan
D Ölwanne
PL Miska do oleju
RUS Миска для масла
CZ Miska na olej
H Fáradtolaj felfogó edény
RO Recipient pt. ulei
E Escudilla para aceite
CN 接油盆



PP

| | | | |
|-------------|---|--------|----|
| YATO | l | ∅ (cm) | |
| YT-0699 | 8 | 37 | 48 |



PE

| | | | |
|-------------|----|--------|---|
| YATO | l | ∅ (cm) | |
| YT-0716 | 10 | 37 | 6 |
| YT-0717 | 15 | 42 | 4 |

GB Oil drainer
D Oleinflüßanlage
PL Zlewarka do oleju
RUS Устройство для слива масла
CZ Olejová nádrž s odsávaním
H Fáradtolaj leszívó
RO Dispozitiv pt. schimbat ulei
E Decantador para aceite
CN 泄油器



75-155 cm **PE**

WHITE CARTON BOX & COLOR LABEL



| | | | |
|-------------|----|--------|---|
| YATO | l | ∅ (cm) | |
| YT-0718 | 20 | 42 | 1 |

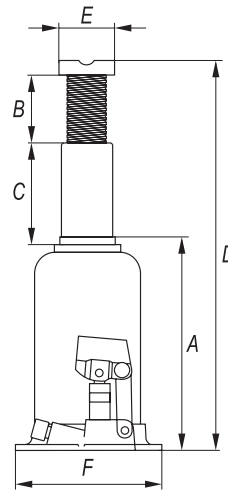

- GB Hydraulic bottle jack
- D Hydraulischer Stempelwagenheber
- PL Podnośnik hydrauliczny słupkowy
- RUS Домкрат гидравлический
- CZ Pístový zvedák hydraulický
- H Hidraulikus emelő
- RO Cric hidraulic
- E Gato de embolo hidr.
- CN 立式液压千斤顶



ELECTROLESS
NICKEL
PLATING

COLOR BOX



| YATO  | T | A (mm) | B (mm) | C (mm) | D (mm) | E (mm) | F (mm) |  |
|--|----|--------|--------|--------|--------|--------|-----------|---|
| YT-1702 | 5 | 212 | 110 | 146 | 468 | 40 | 110x112 | 5 |
| YT-1704 | 10 | 220 | 115 | 148 | 483 | 48 | 124x127.5 | 3 |
| YT-1706 | 15 | 231 | 113 | 154 | 498 | 56 | 140x142 | 2 |
| YT-1707 | 20 | 241 | 115 | 165 | 521 | 60 | 165x161 | 2 |
| YT-1709 | 30 | 244 | 108 | 140 | 492 | 65 | 186x174 | 1 |

- GB Two-piston hydraulic bottle jack
- RUS Домкрат гидравлический
- RO Cric hidraulic
- D Hydraulischer Stempelwagenheber
- CZ Pístový zvedák hydraulický
- E Gato de embolo hidr.
- PL Podnośnik hydrauliczny słupkowy dwutłokowy
- H Hidraulikus emelő
- CN 液压双级千斤顶

COLOR
BOX





ELECTROLESS
NICKEL
PLATING



5t



500
↓
220
mm

| YATO  | T |  |
|--|---|---|
| YT-1711 | 5 | 2 |



10t

225
↓
125
mm

| YATO  | T |  |
|--|----|---|
| YT-1713 | 10 | 2 |



10t



523
↓
208
mm

| YATO  | T |  |
|--|----|---|
| YT-1714 | 10 | 1 |



12t

593
↓
230
mm

| YATO  | T |  |
|--|----|---|
| YT-1715 | 12 | 1 |

- GB Hydraulic floor jack
- D Hydraulischer Rangierwagenheber
- PL Podnośnik hydrauliczny
- RUS Домкрат гидравлический
- CZ Pístový zvedák hydraulický
- H Hidraulikus emelő
- RO Cric tip crocodil
- E Gato de embolo hidr.
- CN 卧式液压千斤顶



LOW PROFILE



1.25t

375 mm
↓
80 mm

AI

COLOR BOX



| YATO  | T |  |
|--|------|---|
| YT-1719 | 1.25 | 1 |





2t

359 mm
↓
89 mm

BMC & COLOR SLEEVE



| YATO  | T |  |
|---|---|--|
| YT-1720 | 2 | 1 |





2.5t

457 mm
↓
89 mm

COLOR BOX



| YATO  | T |  |
|--|-----|---|
| YT-1721 | 2.5 | 1 |

- GB Work bench
- D Lackierständer, verstellbar
- PL Stojak lakierniczy rozstawny
- RUS Раздвижная лакировочная стойка
- CZ Stojan lakýrnický rozkládací
- H Kinyitható lakkozó állvány
- RO Suport extensibil pt. lacuit
- E Montante plegable para barnizar
- CN 工作台



10 kg max  50 cm
85 cm

150 kg max  100 cm
45 cm



COLOR BOX

| YATO  |  |
|--|---|
| YT-5555 | 1 |

GB Electronic battery charger
D Elektronisches Ladegerät
PL Prostownik elektroniczny
RUS Электронное зарядное устройство
CZ Elektronická nabíječka
H Elektronikus akkumulátortöltő
RO Redresor electric
E Rectificador electrónico
CN 蓄电池充电器

COLOR BOX



| | |
|-------------------------------|------------------|
| 6 V | 1 A |
| 12 V | 4 A |
| 200 Ah max | 230V~50Hz |
| WET GEL AGM | MOKRY ZELOWY AGM |
| MICROPROCESSOR MICROPROCESSOR | |



| | |
|---|---|
| YATO  |  |
| YT-8300 | 8 |



| | |
|-------------------------------|------------------|
| 230V~50Hz | 5-160 Ah |
| 2 A | 12 V |
| 8 A | |
| WET GEL AGM | MOKRY ZELOWY AGM |
| MICROPROCESSOR MICROPROCESSOR | |



| | |
|-------------------------------|------------------|
| 6 V | 8 A |
| 12 V | |
| 5-200 Ah | 230V~50Hz |
| WET GEL AGM | MOKRY ZELOWY AGM |
| MICROPROCESSOR MICROPROCESSOR | |

| | |
|---|---|
| YATO  |  |
| YT-83016 | 12 |

| | |
|---|---|
| YATO  |  |
| YT-8301 | 8 |

GB Electronic battery charger
D Elektronisches Ladegerät
PL Prostownik elektroniczny
RUS Электронное зарядное устройство
CZ Elektronická nabíječka
H Elektronikus akkumulátortöltő
RO Redresor electric
E Rectificador electrónico
CN 蓄电池充电器

COLOR BOX



| | |
|-------------------------------|-----------|
| 12 V | 12 A |
| 6-200 Ah | 230V~50Hz |
| MICROPROCESSOR MICROPROCESSOR | WET MOKRY |

| | |
|------------------|-------------------------------|
| 12 V | |
| 15 A | 6-200 Ah |
| 230V~50Hz | WET GEL AGM |
| MOKRY ZELOWY AGM | MICROPROCESSOR MICROPROCESSOR |



| | |
|---|---|
| YATO  |  |
| YT-8302 | 8 |

| | |
|---|---|
| YATO  |  |
| YT-8303 | 8 |

GB Battery charger
D Ladegerät
PL Prostownik
RUS Зарядное устройство

CZ Nabíječka
H Akkumulátortöltő
RO Redresor

E Rectificador
CN 蓄电池充电器

COLOR BOX



230V~ 50Hz 12 V 24 V



16 A 120-240 Ah WET MOKRY



25 A 170-350 Ah WET MOKRY

YATO YT-8304 2

YATO YT-8305 2



15 A 10-300 Ah WET MOKRY AGM BOOST ROZRUCH 12 V 75 A MICROPROCESSOR MIKROPROCESOR



30 A 50-600 Ah WET MOKRY AGM BOOST ROZRUCH 12 V 145 A MICROPROCESSOR MIKROPROCESOR

YATO YT-83051 2

YATO YT-83052 2

GB Battery charger with a starter
D Ladegerät mit starterfunktion
PL Prostownik z rozruchem
RUS Выпрямитель с функцией запуска
CZ Nabíječka s funkcí startování motoru

H Akkumulátortöltő - indító
RO Redresor cu pornire
E Rectificador con arranque
CN 蓄电池充电器

GREY CARTON BOX & COLOR LABEL



230V~ 50Hz WET MOKRY

16



12 V 27 A START ROZRUCH 300 A
24 V 25 A START ROZRUCH 240 A
20-600 Ah



12 V 32 A START ROZRUCH 390 A
24 V 31 A START ROZRUCH 360 A
20-700 Ah



12 V 38 A START ROZRUCH 540 A
24 V 35 A START ROZRUCH 450 A
20-800 Ah

YATO YT-83060 1

YATO YT-83061 1

YATO YT-83062 1

GB Jumpstart wires
D Starterkabel
PL Przewody rozruchowe
RUS Пусковые провода
CZ Startovací kabely



H Indító kábelek
RO Cabluri demarare
E Cables de arranque
CN 输出线



WINDOW BAG
WITH ZIPPER



2.5m



| YATO  | rated load / obciążenie nominalne (A) |  |
|--|---------------------------------------|---|
| YT-83150 | 120 | 20 |
| YT-83151 | 200 | 12 |

| YATO  | rated load / obciążenie nominalne (A) |  |
|--|---------------------------------------|---|
| YT-83152 | 400 | 12 |
| YT-83153 | 600 | 12 |

GB Analogue battery tester
D Analoges Batterieprüfgerät
PL Tester akumulatorów analogowy
RUS Аналоговый тестер аккумуляторов
CZ Analogový tester akumulátorů
H Analóg akkuteszter
RO Tester acumulatori analog
E Tester analógico para acumuladores
CN 电池测试器

6 V

12 V

CCA
200-
1000 A

GB Digital battery tester
D Digitales Batterieprüfgerät
PL Tester akumulatorów cyfrowy
RUS Цифровой тестер аккумуляторов
CZ Digitální tester akumulátorů
H Digitális akkuteszter
RO Tester acumulatori digital
E Tester digital para acumuladores
CN 电池测试器

12 V

LED
DISPLAY

CCA
150-
1400 A

GB Battery tester
D Batterieprüfgerät
PL Tester akumulatorów
RUS Тестер аккумуляторов
CZ Tester akumulátorů
H Akkuteszter
RO Tester acumulatori
E Tester para acumuladores
CN 电池测试器

12 V

BATTERY
TEST
TEST
AKUMULATORA

ALTERNATOR
TEST
TEST
ALTERNATORA



COLOR BOX



COLOR BOX



DOUBLE BLISTER



| YATO  |  |
|--|---|
| YT-8310 | 10 |

| YATO  |  |
|--|---|
| YT-8311 | 10 |

| YATO  |  |
|--|---|
| YT-83101 | 12/72 |

GB Chain block
 D Kettenzug Flaschenzug
 PL Wyciągarka łańcuchowa
 RUS Таль цепная
 CZ Zvedák řetězový
 H Lánchos csigasor emelő
 RO Scripete cu lant
 E Cabria de cadena
 CN 手拉葫芦

COLOR BOX



3m

GB Electric hoist
 D Elektro-Seilwinde
 PL Elektryczna wciągarka linowa
 RUS Электрическая канатная лебедка
 CZ Elektrický naviják kladkostroj
 H Elektromos csőrőlő
 RO Troliu electric cu cablu
 E Cabria eléctrica de cuerdas
 CN 电动葫芦

~230V
50Hz



COLOR BOX



| | | | | | |
|-------------|---|---------|-------------|---|---------|
| YATO | 1 | 500 kg | YATO | 1 | 2000 kg |
| YT-5890 | 1 | | YT-5893 | 1 | |
| YATO | 1 | 1000 kg | YATO | 1 | 3000 kg |
| YT-5892 | 1 | | YT-5894 | 1 | |

| | | | | | | | |
|-------------|---|-------------------|-------------------|-------------|---|-------------------|-------------------|
| YATO | 2 | 125 kg | 250 kg | YATO | 2 | 250 kg | 500 kg |
| YT-5901 | 2 | 10 m/min max. 11m | 5 m/min max. 5.5m | YT-5904 | 2 | 10 m/min max. 11m | 5 m/min max. 5.5m |
| YATO | 2 | 150 kg | 300 kg | YATO | 2 | 300 kg | 600 kg |
| YT-5902 | 2 | 10 m/min max. 11m | 5 m/min max. 5.5m | YT-5905 | 2 | 10 m/min max. 11m | 5 m/min max. 5.5m |

GB Rope winch
 D Handseilwinde
 PL Wyciągarka linowa

RUS Канатная лебедка
 CZ Lanové vyťahovací zařízení
 H Drótkételes csőrőlő

RO Troliu cu cablu orizontal
 E Cabria de cuerdas
 CN 绳索拉紧器

COLOR BOX



1000 daN

| YATO | daN | L (m) | Ø (mm) | Box |
|---------|------|-------|--------|-----|
| YT-5911 | 1000 | 3 | 5 | 6 |



1300 daN

| YATO | daN | L (m) | Ø (mm) | Box |
|---------|------|-------|--------|-----|
| YT-5913 | 1300 | 3 | 5 | 6 |



1500 daN

| YATO | daN | L (m) | Ø (mm) | Box |
|---------|------|-------|--------|-----|
| YT-5914 | 1500 | 3 | 6 | 3 |

Memo

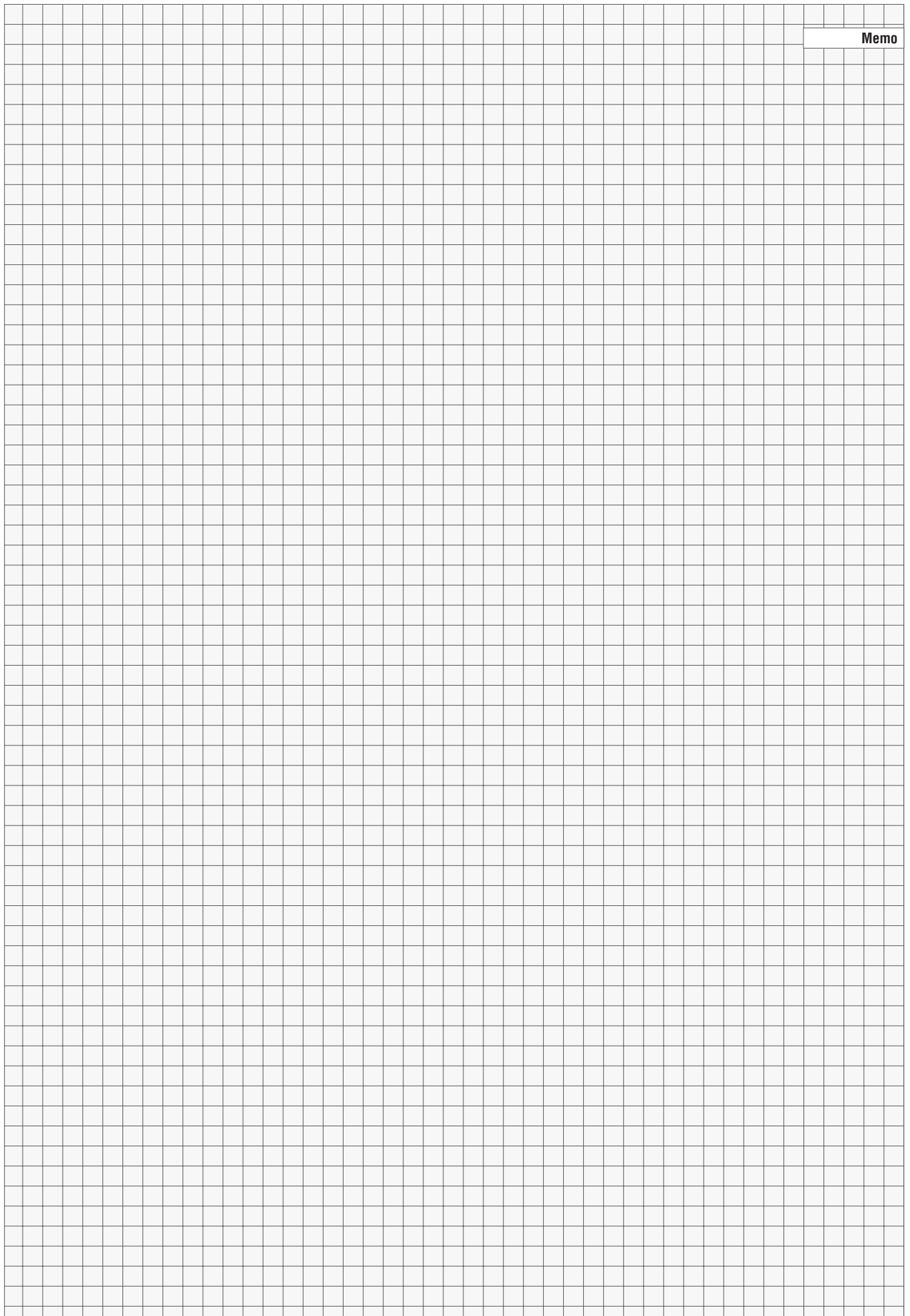

17

Power & gasoline tools Elektronarzędzia i narzędzia spalinowe



Multi-purpose oscillating tools
Wielofunkcyjne narzędzia oscylacyjne

334



Electric hoists
Elektryczne wciągarki linowe

337



Hot air guns
Opalarki

335



Burners & soldering tools
Palniki i lutownice

337-338



Pipe welders
Zgrzewarki do rur

336



Glue guns
Pistolety do klejenia

338



Pumps
Pompy

336



GB Multi-purpose oscillating tool
 D Multifunktionales Oszillationswerkzeug
 PL Wielofunkcyjne narzędzie oscylacyjne
 RUS Многофункциональный инструмент
 CZ Multifunkční oscilační nářadí
 H Multifunkciós rezgő szerszám
 RO Unealtă multifuncțională oscilantă
 E Herramienta oscilatoria multiusos
 CN 多功能啊雄莓

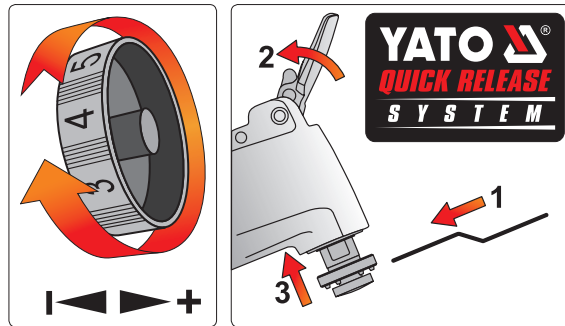

230V~
50Hz

300
W

15000-22000
mm

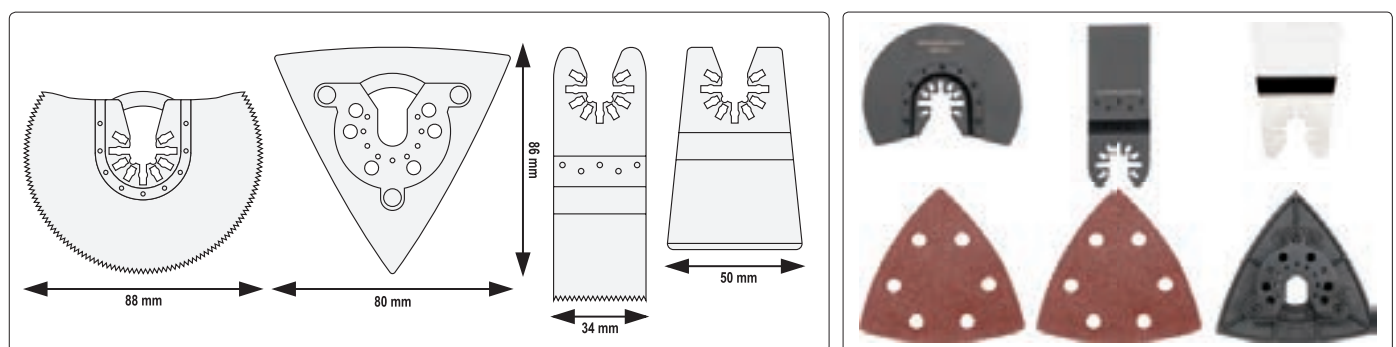
17

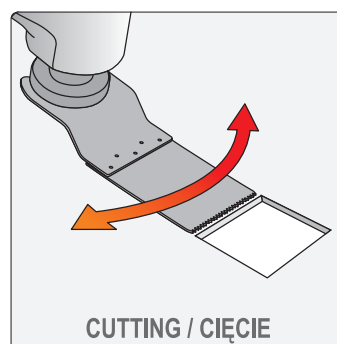
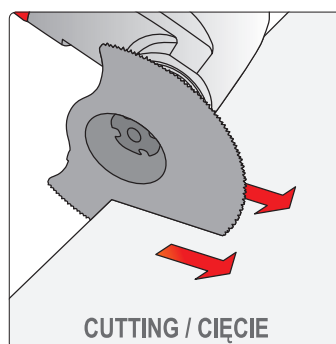

YATO  W 
 YT-82220 300 4

GB Hot air gun
D Heissluftpistole
PL Opalarka
RUS Фен для обжигания краски
CZ Opalovací stroj
H Hőlégfúvó
RO Fion pt. ars vopseaua
E Secadora
CN 热风枪

230V~
50Hz



2000
W

550°C

500
l/min



COLOR
BOX

| | | |
|---|------|---|
| YATO  | W |  |
| YT-82288 | 2000 | 10 |

GB Hot air gun with accessories
D Heissluftpistole
PL Opalarka z akcesoriami
RUS Фен для обжигания краски в наборе
CZ Opalovací stroj s příslušenstvím
H Hőlégfúvó tartozékokkal
RO Fion cu accesorii pt. ars vopseaua
E Secadora con accesorios
CN 热风枪

230V~
50Hz



2000
W

550°C

500
l/min



BMC
& COLOR
SLEEVE

| | | |
|---|------|---|
| YATO  | W |  |
| YT-82291 | 2000 | 5 |

GB Hot air gun with accessories
D Heissluftpistole
PL Opalarka z akcesoriami
RUS Фен для обжигания краски в наборе
CZ Opalovací stroj s příslušenstvím
H Hőlégfúvó tartozékokkal
RO Fion cu accesorii pt. ars vopseaua
E Secadora con accesorios
CN 热风枪

230V~
50Hz

2000
W

550°C

500
l/min

LED



TEMPERATURE
ADJUSTMENT



REGULACJA
TEMPERATURY

GB Hot air gun with accessories
D Heissluftpistole
PL Opalarka z akcesoriami
RUS Фен для обжигания краски в наборе
CZ Opalovací stroj s příslušenstvím
H Hőlégfúvó tartozékokkal
RO Fion cu accesorii pt. ars vopseaua
E Secadora con accesorios
CN 热风枪

230V~
50Hz

2000
W

600°C

500
l/min

LCD
DISPL. BY



TEMPERATURE
ADJUSTMENT



REGULACJA
TEMPERATURY



BMC
& COLOR
SLEEVE

| | | |
|---|------|---|
| YATO  | W |  |
| YT-82292 | 2000 | 5 |



BMC
& COLOR
SLEEVE

| | | |
|---|------|---|
| YATO  | W |  |
| YT-82293 | 2000 | 5 |

GB PVC plastic pipe welder
 D Schweißgerät für thermoplastische Rohre
 PL Zgrzewarka do rur termoplastycznych
 RUS Сварочная машина для термопластиковых труба
 CZ Svářečka na termoplastické trubky
 H Hegesztő berendezés termoplasztikus csövekhez
 RO Masina de sudat tevi termoplastice
 E Máquina de soldar las tubos termoplásticos
 CN 热熔器

230V~50Hz 850 W 0-300°C Ø 20, 25, 32 [mm] 40, 50, 63



METAL CASE & COLOR BOX



| | | |
|-------------|-----|---|
| YATO | W | |
| YT-82250 | 850 | 4 |

GB Gasoline water pump
 D Pumpe mit verbrennungsmotor
 PL Pompa spalinowa
 RUS Бензонасос
 CZ Čerpadlo
 se spalovacím motorem
 H Robbanómotoros szivattyú
 RO Pompa cu motor cu ardere interna
 E Bomba de combustion
 CN 汽油抽水泵

4.1 kW
 163 cm³
 Q_{MAX} 600 l/min
 50mm 2"
 Q_{MAX} 36m³/h
 30m
 8m
 3.6 l

GB Gasoline water pump
 D Pumpe mit verbrennungsmotor
 PL Pompa spalinowa
 RUS Бензонасос
 CZ Čerpadlo
 se spalovacím motorem
 H Robbanómotoros szivattyú
 RO Pompa cu motor cu ardere interna
 E Bomba de combustion
 CN 汽油抽水泵

4.1 kW
 163 cm³
 Q_{MAX} 1000 l/min
 80mm 3"
 Q_{MAX} 60m³/h
 30m
 8m
 3.6 l

GB Gasoline water pump
 D Pumpe mit verbrennungsmotor
 PL Pompa spalinowa
 RUS Бензонасос
 CZ Čerpadlo
 se spalovacím motorem
 H Robbanómotoros szivattyú
 RO Pompa cu motor cu ardere interna
 E Bomba de combustion
 CN 汽油抽水泵

5.7 kW
 242 cm³
 Q_{MAX} 1600 l/min
 100mm 4"
 Q_{MAX} 96m³/h
 20m
 8m
 5.5 l



COLOR BOX



| | |
|-------------|---|
| YATO | |
| YT-85401 | 1 |



COLOR BOX



| | |
|-------------|---|
| YATO | |
| YT-85402 | 1 |



COLOR BOX













| | |
|-------------|---|
| YATO | |
| YT-85403 | 1 |





GB Electric hoist
D Elektro-Seilwinde
PL Elektryczna wciągarka linowa
RUS Электрическая канатная лебёдка
CZ Elektrický naviják kladkostroj
H Elektromos csőrő
RO Troliu electric cu cablu
E Cabría eléctrica de cuerdas
CN 电动葫芦







~230V
50Hz  

| | | |
|---|---|---|
| 500W |  |  |
| YATO W  |  |  |
| YT-5901 500 2 | 125 kg | 250 kg |

| | | |
|---|---|---|
| 550W |  |  |
| YATO W  |  |  |
| YT-5902 550 2 | 150 kg | 300 kg |



| | | |
|---|---|---|
| 900W |  |  |
| YATO W  |  |  |
| YT-5904 900 2 | 250 kg | 500 kg |

| | | |
|--|--|--|
| 1050W |  |  |
| YATO W  |  |  |
| YT-5905 1050 2 | 300 kg | 600 kg |

COLOR BOX



GB Butane torch
D Gasbrenner
PL Palnik gazowy
RUS Газовая горелка
CZ Plynový hořák
H Gázégő
RO Arzător de gaz
E Soplete de gas
CN 火焰枪

PIEZO ELECTRIC  **1350°C**  **60ml**  **200 min** 



HANGING COLOR BOX



| | | |
|---|---|---|
| YATO  | W |  |
| YT-6700 | | 6/24 |



GB Butane soldering tool
D Gaslötkolben
PL Lutownica gazowa
RUS Паяльник газовый
CZ Plynová pájka

H Forrasztópisztoly ceruza
bután gáz üzemű
RO Surubelnita sudura cu gaz
E Microsoldador de butano portatil
CN 瓦斯焊接工具

SLIDING CARD



1300°C  **210-400°C**  **20ml**  **25-80 W**  **120 min** 

| | | |
|---|-------|---|
| YATO  | W |  |
| YT-6705 | 25-80 | 12/72 |



PIEZO ELECTRIC  **1300°C**  **250-550°C**  **38 ml**  **30-125 W**  **200 min** 

| | | |
|---|--------|---|
| YATO  | W |  |
| YT-6706 | 30-125 | 12/48 |

GB Soldering iron
 D LötKolben
 PL Lutownica oporowa
 RUS Электропаяльник
 CZ Pájka odporová
 H Forrasztópáka
 RO Ciocan de lipit
 E Soldador de resistencia
 CN 电烙铁

230V~
50Hz



HANGING
DISPLAY
COLOR BOX

| YATO | W | working temp. of soldering tip (°C) | dimensions of soldering tip (mm) | |
|---------|----|-------------------------------------|----------------------------------|----|
| YT-8271 | 30 | 400 | ø3.8 x 70 | 16 |
| YT-8272 | 60 | 500 | ø6.0 x 78 | 16 |
| YT-8273 | 80 | 520 | ø6.8 x 64 | 16 |

GB Transformer soldering gun
 D Lötpestole
 PL Lutownica transformatorowa
 RUS Паяльник электрический
 CZ Transformátorová páječka
 H Forrasztópáka
 RO Aparat de lipit letcon cu transformator
 E Soldador transformador
 CN 电烙铁

230V~
50Hz

180
W



BMC
& COLOR
SLEEVE

| YATO | W | |
|---------|-----|----|
| YT-8245 | 180 | 10 |

GB Electric glue gun
 D Heissklebepistole
 PL Pistolet do klejenia
 RUS Пистолет для клея
 CZ Pistole na lepení
 H Ragasztópisztoly
 RO Pistol pt. lipit
 E Pistola de cola
 CN 热胶枪

230V~
50Hz

35
(400)
W

11 mm



COLOR
BOX

| YATO | W | |
|----------|----------|-------|
| YT-82401 | 35 (400) | 12/24 |

GB Cordless glue gun
 D Heissklebepistole
 PL Akumulatorowy pistolet do klejenia
 RUS Пистолет для клея
 CZ Pistole na lepení
 H Ragasztópisztoly
 RO Pistol pt. lipit
 E Pistola de cola
 CN 热胶枪

7.4 V
2.6 Ah
Li-Ion



8W

11 mm



DOUBLE
BLISTER

| YATO | W | |
|----------|---|------|
| YT-82421 | 8 | 6/24 |

Memo

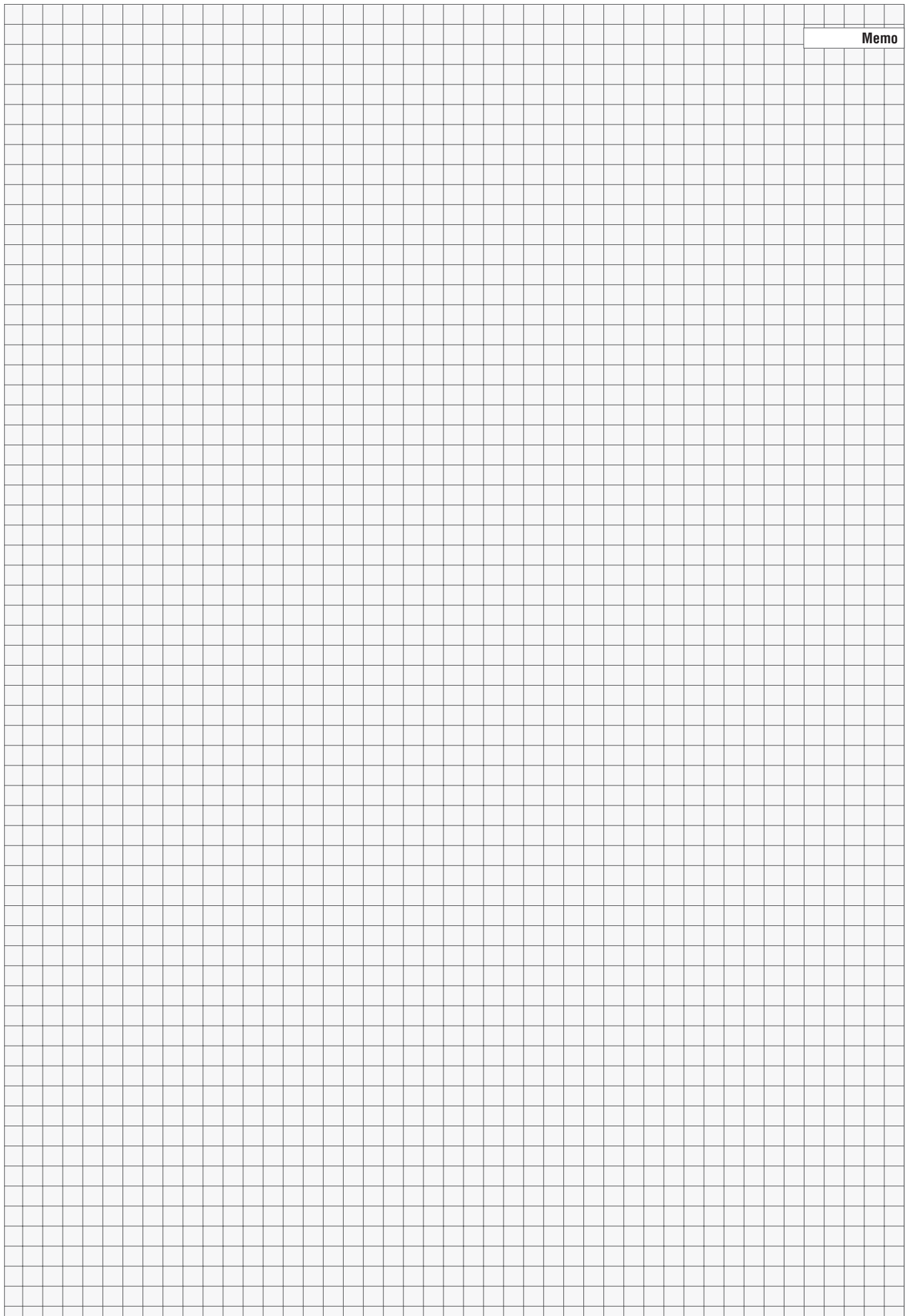

18

Padlocks & lock cylinders Kłódki i wkładki do zamków



Brass padlocks
Kłódki mosiężne

342



Lock cylinders
Wkładki do zamków

343



Arbor padlocks
Kłódki trzpieniowe

342



Brass lock cylinders

Wkładki mosiężne..... 343

Brass lock cylinders with knob



Wkładki mosiężne z gałką..... 343

GB Brass padlock
 D Vorhängeschloss
 PL Klódka mosiężna
 RUS Стержневой навесной латунный
 CZ Zámek visací mosazný
 H Lakat sárgaréz
 RO Lacat alama
 E Candado de latón
 CN 铜挂锁

4x1 **BRASS**
 MOSIADZ



DOUBLE BLISTER



| YATO  | L (mm) |  |
|--|--------|---|
| YT-6960 | 40 | 6/72 |
| YT-6961 | 50 | 6/48 |
| YT-6962 | 60 | 6/36 |

GB Brass padlock
 D Vorhängeschloss
 PL Klódka mosiężna
 RUS Стержневой навесной латунный
 CZ Zámek visací mosazný
 H Lakat sárgaréz
 RO Lacat alama
 E Candado de latón
 CN 铜挂锁

4x1 **BRASS**
 MOSIADZ



DOUBLE BLISTER



| YATO  | L (mm) |  |
|--|--------|---|
| YT-6963 | 30 | 6/96 |
| YT-6964 | 40 | 6/72 |
| YT-6965 | 50 | 6/60 |
| YT-6966 | 60 | 6/36 |

GB Arbor brass padlock
 D Vorhängeschloss
 PL Klódka trzpieniowa
 RUS Стержневой навесной замок чугунный
 CZ Stavební visací zámek
 H Óriás lakat
 RO Lacăt
 E Candado de mandril de hierro fundido cubierto
 CN 挂锁

4x1 **BRASS**
 MOSIADZ



DOUBLE BLISTER



| YATO  | L (mm) |  |
|--|--------|---|
| YT-6980 | 40 | 6/96 |
| YT-6981 | 50 | 6/72 |
| YT-6982 | 60 | 6/60 |
| YT-6983 | 70 | 6/36 |
| YT-6984 | 80 | 6/30 |
| YT-6985 | 90 | 6/24 |

GB Arbor brass padlock
 D Vorhängeschloss
 PL Klódka trzpieniowa
 RUS Стержневой навесной замок чугунный
 CZ Stavební visací zámek
 H Óriás lakat
 RO Lacăt
 E Candado de mandril de hierro fundido cubierto
 CN 挂锁

4x1 **BRASS**
 MOSIADZ



DOUBLE BLISTER

| YATO  | L (mm) |  |
|--|--------|---|
| YT-6986 | 40 | 6/48 |
| YT-6987 | 50 | 6/48 |
| YT-6988 | 60 | 6/48 |
| YT-6989 | 70 | 6/24 |

GB Lock cylinder
D Schliesszylinder
PL Wkładka do zamka
RUS Замок цилиндрический
CZ Vložka na zámek
H Zárbetét
RO Yală pt. broască
E Inserción de latón
CN 锁芯

BRASS
MOSIADZ





Lock cylinder received „Test Certificate”
issued by Instytut Techniki Budowlanej

Wkładka posiada „Świadectwo Badań”
wystawione przez Instytut Techniki Budowlanej

COLOR BOX
& MESH
PLASTIC TRAY



| YATO  | L (mm) | mm |  |
|--|--------|-------|---|
| YT-69900 | 62 | 31/31 | 12/60 |
| YT-69901 | 67 | 31/36 | 12/60 |
| YT-69902 | 72 | 31/41 | 12/60 |
| YT-69903 | 87 | 36/51 | 12/60 |

GB Lock cylinder
D Schliesszylinder
PL Wkładka do zamka
RUS Замок цилиндрический
CZ Vložka na zámek
H Zárbetét
RO Yală pt. broască
E Inserción de latón
CN 锁芯

BRASS
MOSIADZ





Lock cylinder received „Test Certificate”
issued by Instytut Techniki Budowlanej

Wkładka posiada „Świadectwo Badań”
wystawione przez Instytut Techniki Budowlanej

COLOR BOX
& MESH
PLASTIC TRAY



| YATO  | L (mm) | mm |  |
|--|--------|-------|---|
| YT-69910 | 62 | 31/31 | 12/60 |
| YT-69911 | 67 | 31/36 | 12/60 |
| YT-69912 | 67 | 36/31 | 12/60 |
| YT-69913 | 72 | 31/41 | 12/60 |
| YT-69914 | 72 | 41/31 | 12/60 |

GB Lock cylinder
D Schliesszylinder
PL Wkładka do zamka
RUS Замок цилиндрический
CZ Vložka na zámek
H Zárbetét
RO Yală pt. broască
E Inserción de latón
CN 锁芯

BRASS
MOSIADZ





Lock cylinder received „Test Certificate”
issued by Instytut Techniki Budowlanej

Wkładka posiada „Świadectwo Badań”
wystawione przez Instytut Techniki Budowlanej

COLOR BOX
& MESH
PLASTIC TRAY



| YATO  | L (mm) | mm |  |
|--|--------|-------|---|
| YT-69905 | 62 | 31/31 | 12/60 |
| YT-69906 | 67 | 31/36 | 12/60 |
| YT-69907 | 72 | 31/41 | 12/60 |
| YT-69908 | 87 | 36/51 | 12/60 |

GB Lock cylinder
D Schliesszylinder
PL Wkładka do zamka
RUS Замок цилиндрический
CZ Vložka na zámek
H Zárbetét
RO Yală pt. broască
E Inserción de latón
CN 锁芯

BRASS
MOSIADZ





Lock cylinder received „Test Certificate”
issued by Instytut Techniki Budowlanej

Wkładka posiada „Świadectwo Badań”
wystawione przez Instytut Techniki Budowlanej

COLOR BOX
& MESH
PLASTIC TRAY



| YATO  | L (mm) | mm |  |
|--|--------|-------|---|
| YT-69920 | 62 | 31/31 | 12/60 |
| YT-69921 | 67 | 31/36 | 12/60 |
| YT-69922 | 67 | 36/31 | 12/60 |
| YT-69923 | 72 | 31/41 | 12/60 |
| YT-69924 | 72 | 41/31 | 12/60 |

19

Accessories Akcesoria



Tool belts
Pasy na narzędzia

346



Tool bags
Torby narzędziowe

347



Tool pockets
Kieszenie na narzędzia

346-347



- GB Heavy duty nail & tool pouch
- D Werkzeuggürtel mit Nägel- und Schraubentaschen
- PL Pas z kieszeniami na gwoździe i narzędzia
- RUS Ремень с сумками для гвоздей и инструментов
- CZ Pás na nářadí pětikapsový
- H Szeg és szerszámartató öv
- RO Centura port scule
- E Cinturón porta herramientas y accesorios varios
- CN 重型工具袋



21
POCKETS
KIESZENI

120
cm

HEAVY
DUTY
NYLON

COLOR BOX



COWHIDE BELT



| | |
|-------------|----|
| YATO | |
| YT-7400 | 10 |

- GB Pouch belt
- D Gürtel für Werkzeugtaschen
- PL Pas na kieszenie na narzędzia
- RUS Пояс для карманов для инструмента
- CZ Opasek na monterské kapsáře
- H Öv erszényhez
- RO Curea cu buzunar
- E Cinturón para bolsas de herramientas
- CN 工具腰带



HEADER
CARD



90-120
cm

HEAVY
DUTY
NYLON

| | |
|-------------|--------|
| YATO | |
| YT-7409 | 50/100 |

- GB 8-pocket tool bag
- D Gürtelwerkzeugtasche mit 8 Fächern
- PL 8. kieszeniowa torba na narzędzia
- RUS Сумка - 8 карманов для инструмента
- CZ Kapsář na nářadí 8-kapsový
- H Szerszámartató erszény, 8 zsebbel
- RO Geanta pt. scule 8 buzunare
- E Bolso para herramientas de 8 bolsillos
- CN 工具包

HEADER
CARD



8
POCKETS
KIESZENI

HEAVY
DUTY
NYLON



| | |
|-------------|-------|
| YATO | |
| YT-7410 | 20/40 |

- GB Universal cordless drill holder
- D Gürteltasche für Akkuschauber
- PL Kieszeń na wiertarkę akumulatorową
- RUS Карман для аккумуляторной дрели
- CZ Kapsář za opasek na akuvrtáčku
- H Univerzális tartóerszény akkus csavabehajtóhoz

- RO Suport universal pt. bormasina
- E Bolsa porta taladradora de acumulador
- CN 电钻通用挂袋

HEADER
CARD



HEAVY
DUTY
NYLON



| | | | |
|-------------|-------|-------------|-------|
| YATO | | YATO | |
| YT-7413 | 20/40 | YT-7414 | 48/96 |

- GB Nail / tool pouch
- D Gürtelwerkzeugtasche
- PL Kieszeń na gwoździe i narzędzia
- RUS Карман для гвоздей и инструментов
- CZ Kapsář na nářadí
- H Szeg és szerszámartató erszény
- RO Buzunar pt. scule / cuie
- E Bolsa porta herramientas y accesorios varios
- CN 钉子袋

HEADER
CARD



HEAVY
DUTY
NYLON



| | | | |
|-------------|-------|-------------|--------|
| YATO | | YATO | |
| YT-7416 | 20/40 | YT-7417 | 39/156 |

- GB Nail pocket + hammer loop
D Hammer und Nägel-Gürteltasche
PL Kieszzeń z uchwytem na młotek
RUS Карман-держатель для молотка
CZ Kapsář za opasek na kladivo
H Szeg tartó erszény kalapáccstartóval
RO Suport pt. ciocan
E Bolsa con el soporte para martillo
CN 锤头钉子袋



HEAVY
DUTY
NYLON

HEADER
CARD



YATO 

YT-7419



40/80

- GB Mobile phone pouch
D Handy-Gürteltasche
PL Kieszzeń na telefon komórkowy
RUS Карман для мобильного телефона
CZ Pouzdro za opasek na mobilni telefon
H Mobil telefon tartó
RO Suport pt. telefon
E Bolsa de teléfono móvil
CN 手机袋



HEAVY
DUTY
NYLON

HEADER
CARD



YATO 

YT-7420



27/54

- GB Tool bag
D Werkzeugtasche
PL Torba na narzędzia
RUS Сумка для инструмента
- CZ Taška montérská
H Szerszámos táská
RO Geanta pt. scule
- E Bolso
de herramientas
- CN 工具包



16
POCKETS
KIESZENI

YATO 

YT-7430



12

YATO 

YT-7433



12

- GB Steel tube tool carrier
D Werkzeugkoffer
PL Walizka narzędziowa
RUS Семодан для инструмента
CZ Taška na nářadí
H Szerszámtartó csövázás
RO Geanta de otel pt. portbagaj
E Maletín de herramientas
CN 钢管柄工具包



31
POCKETS
KIESZENI

HEAVY
DUTY
NYLON

- GB Foldable chair with bag
D Werkzeugtasche mit Klappstuhl
PL Torba narzędziowa z krzeselkiem
RUS Стул складной с сумкой для инструмента
CZ Taška na nářadí se stojánkem
H Összecsukható szék tartózsebbel
RO Scaun rabatabil cu geanta
E Bolso de herramientas con silla plegable
CN 带包折叠椅

22
POCKETS
KIESZENI

HEAVY
DUTY
NYLON



YATO 

YT-7435



4

YATO 

YT-7446









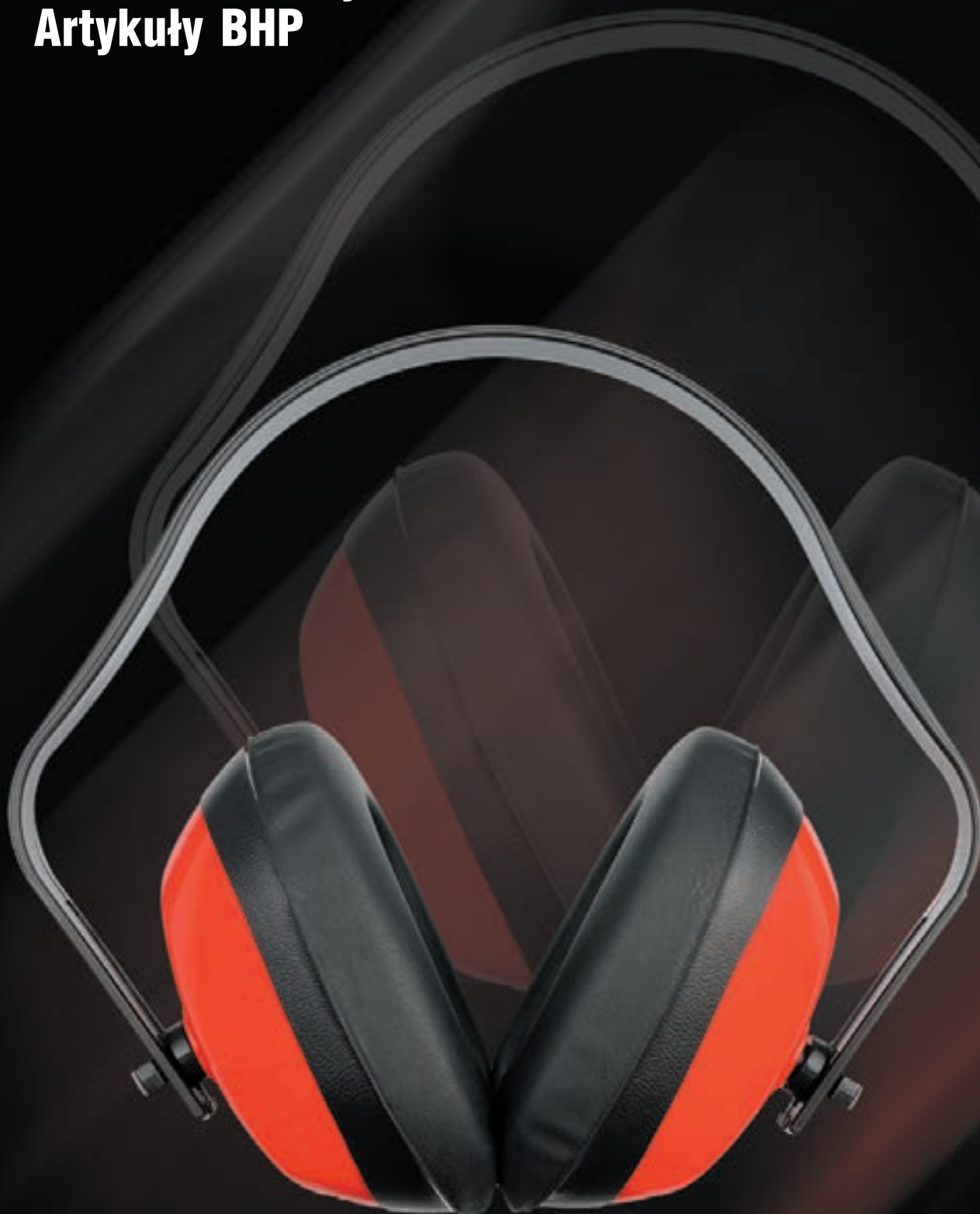

10

20

Health & safety articles
Artykuły BHP



| | |
|--|---|
| <p>Safety glasses Okulary ochronne</p> <p style="text-align: right;">350</p>  | <p>Hearing protectors Nauszniki przeciwhałasowe</p> <p style="text-align: right;">354</p>  |
| <p>Safety goggles Gogle ochronne</p> <p style="text-align: right;">351</p>  | <p>Working shoes Buty robocze</p> <p style="text-align: right;">355-356</p>  |
| <p>Working gloves Rękawice robocze</p> <p style="text-align: right;">351-352</p>  | <p>Low-cut safety shoes Półbuty robocze..... 355</p> <p>Middle-cut safety shoes Trzewiki robocze..... 355</p> |
| <p>Knee pads Nakolanniki</p> <p style="text-align: right;">352</p>  | <p>Working clothes Odzież robocza</p> <p style="text-align: right;">357</p>  |
| <p>Disposable dust masks Półmaski filtrujące</p> <p style="text-align: right;">353</p>  | <p>Working jackets Bluzy robocze..... 357</p> <p>Working trousers Spodnie robocze..... 357</p> <p>Working overalls Spodnie robocze ogrodniczki..... 357</p> |
| <p>Ear plugs Zatyczki do uszu</p> <p style="text-align: right;">354</p>  | |

GB Safety glasses
D Schutzbrille
PL Okulary ochronne

RUS Очки защитные открытые
CZ Ochranné brýle
H Védőszemüveg

RO Ochelari pt. protectie
E Gafas protectoras
CN 劳保眼镜

PAPER
HANGING
CARD



TYPE 90960 EN 166:2001 F

| | |
|---|---|
|  |  |
| YT-7360 | 12/240 |



TYPE 9844 EN 166:2001 F

| | |
|---|--|
|  |  |
| YT-7361 | 12/240 |



TYPE 91977 EN 166:2001 F

| | |
|---|---|
|  |  |
| YT-7363 | 12/240 |



TYPE 91659 EN 166:2001 F

| | |
|---|---|
|  |  |
| YT-7365 | 12/240 |



TYPE 91708 EN 166:2001 F

| | |
|---|--|
|  |  |
| YT-7367 | 12/240 |



TYPE 91797 EN 166:2001 F

| | |
|---|---|
|  |  |
| YT-7369 | 12/240 |



TYPE 91692 EN 166:2001 F

| | |
|---|---|
|  |  |
| YT-7371 | 12/240 |



TYPE B524 EN 166:2001 F

| | |
|---|--|
|  |  |
| YT-73631 | 12/300 |



TYPE B532 EN 166:2001 F

| | |
|---|---|
|  |  |
| YT-73761 | 12/300 |



TYPE 9844 EN 166:2001 F

| | |
|---|---|
|  |  |
| YT-7362 | 12/240 |



TYPE 91977 EN 166:2001 F

| | |
|---|--|
|  |  |
| YT-7364 | 12/240 |





TYPE 91659 EN 166:2001 F

| | |
|---|---|
|  |  |
| YT-7366 | 12/240 |





TYPE 91708 EN 166:2001 F

| | |
|---|---|
|  |  |
| YT-7368 | 12/240 |





TYPE 91293 EN 166:2001 F

| | |
|---|--|
|  |  |
| YT-7374 | 12/240 |



TYPE 91380 EN 166:2001 F

| | |
|---|---|
|  |  |
| YT-7376 | 12/240 |



TYPE B517 EN 166:2001 F

| | |
|---|---|
|  |  |
| YT-73641 | 12/300 |



TYPE B510 EN 166:2001 EN 169:2002

| | |
|---|--|
|  |  |
| YT-73744 | 12/300 |



TYPE B532 EN 166:2001 F

| | |
|---|---|
|  |  |
| YT-73760 | 12/300 |

GB Safety goggles
D Schutzbrille
PL Gogle ochronne

RUS Очки защитные
CZ Ochranné brýle
H Védőszemüveg

RO Ochelari pt. protectie
E Gafas protectoras
CN 劳保眼镜

PAPER
HANGING
CARD



TYPE 2876 EN 166:2001 F

| | |
|---|---|
|  |  |
| YT-7377 | 12/120 |



TYPE #2769 EN 166:2001 F

| | |
|---|---|
|  |  |
| YT-7380 | 20/200 |



TYPE SG90B EN 166:2001 F

| | |
|---|---|
|  |  |
| YT-7381 | 20/200 |



TYPE SG-60 EN 166:2001 B

| | |
|---|---|
|  |  |
| YT-7382 | 10/100 |



TYPE TW2015 EN 166:2001 B

| | |
|---|---|
|  |  |
| YT-7383 | 10/100 |



TYPE B608 EN 166:2001 B

| | |
|---|---|
|  |  |
| YT-73801 | 10/100 |





TYPE B421 EN 166:2001 B

| | |
|---|---|
|  |  |
| YT-73830 | 10/100 |



GB Working gloves
D Arbeitshandschuh
PL Rękawice robocze
RUS Рабочие перчатки
CZ Pracovní rukavice
H Védőkesztyű
RO Mănuși de lucru
E Guantes de piel
CN 劳保手套

PAPER
HEADER





| | | |
|---|----------------|---|
|  | size / rozmiar |  |
| YT-7470 | 10 | 50/100 |





| | | |
|---|----------------|---|
|  | size / rozmiar |  |
| YT-7472 | 10 | 50/100 |



| | | |
|---|----------------|---|
|  | size / rozmiar |  |
| YT-7473 | 10 | 50/100 |



| | | |
|---|----------------|---|
|  | size / rozmiar |  |
| YT-7474 | 10 | 50/100 |

GB Working gloves
 D Arbeitshandschuh
 PL Rękawice robocze
 RUS Рабочие перчатки
 CZ Pracovní rukavice
 H Védőkesztyű
 RO Mănuși de lucru
 E Guantes de piel
 CN 劳保手套



| YATO | size / rozmiar | |
|---------|----------------|--------|
| YT-7480 | 9 | 12/120 |
| YT-7481 | 10 | 12/120 |

| YATO | size / rozmiar | |
|---------|----------------|--------|
| YT-7471 | 10 | 12/120 |



| YATO | size / rozmiar | |
|---------|----------------|--------|
| YT-7476 | 10 | 12/300 |

| YATO | size / rozmiar | |
|---------|----------------|--------|
| YT-7477 | 10 | 12/120 |

GB Working gloves
 D Arbeitshandschuh
 PL Rękawice robocze

RUS Рабочие перчатки
 CZ Pracovní rukavice
 H Védőkesztyű

RO Mănuși de lucru
 E Guantes de piel
 CN 劳保手套



| YATO | size / rozmiar | |
|---------|----------------|-------|
| YT-7464 | 7 / L | 12/48 |
| YT-7465 | 9 / XXL | 12/48 |

| YATO | size / rozmiar | |
|---------|----------------|-------|
| YT-7466 | 7 / L | 12/72 |
| YT-7467 | 9 / XXL | 12/72 |

| YATO | size / rozmiar | |
|---------|----------------|-------|
| YT-7468 | 7 / L | 12/48 |
| YT-7469 | 9 / XXL | 12/48 |

GB Gel knee pads
 D Gel Knieschoner
 PL Nakolanniki żelowe
 RUS Гелевые наколенники
 CZ Nákoleníky gelové
 H Térdvédő zselés

RO Genunchiere
 cu protecție de silikon
 E Protectores
 de gel para rodillas
 CN 护膝



DISPLAY
 COLOR BOX



| YATO | | |
|---------|--|----|
| YT-7460 | | 12 |

| YATO | | |
|---------|--|----|
| YT-7461 | | 12 |

GB Disposable dust masks
D Atemschutzmaske
PL Półmiski filtrujące jednorazowe
RUS Респиратор противопылевой одноразовый
CZ Protiprašná maska
H Eldobható porvédőmaszk
RO Masca praf
E Mascarilla desechable para protección contra polvo
CN 防尘面罩

3
PCS

FFP1 NR



POLYBAG
WITH HEADER

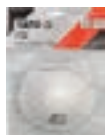

YT-7485



25/100

GB Disposable dust masks with valve
D Atemschutzmaske mit Ventil
PL Półmiski filtrujące jednorazowe z zaworem
RUS Респиратор противопылевой одноразовый с клапаном
CZ Protiprašná maska s ventilom
H Eldobható porvédőmaszk, szelepes
RO Masca praf cu valva
E Mascarilla desechable para protección contra polvo
CN 带阀防尘面罩

3
PCS

FFP1 NR



POLYBAG
WITH HEADER



YT-7486



25/100

GB Disposable dust masks with valve
D Atemschutzmaske mit Ventil
PL Półmiski filtrujące jednorazowe z zaworem
RUS Респиратор противопылевой одноразовый с клапаном
CZ Protiprašná maska s ventilom
H Eldobható porvédőmaszk, szelepes
RO Masca praf cu valva
E Mascarilla desechable para protección contra polvo
CN 带阀防尘面罩

3
PCS

FFP1 NR



POLYBAG
WITH HEADER



YT-7488



25/100

GB Disposable dust masks
D Atemschutzmaske
PL Półmiski filtrujące jednorazowe
RUS Респиратор противопылевой одноразовый
CZ Protiprašná maska
H Eldobható porvédőmaszk
RO Masca praf
E Mascarilla desechable para protección contra polvo
CN 防尘面罩

3
PCS

FFP2 NR



POLYBAG
WITH HEADER



YT-7491



25/100

GB Disposable dust masks with valve
D Atemschutzmaske mit Ventil
PL Półmiski filtrujące jednorazowe z zaworem
RUS Респиратор противопылевой одноразовый с клапаном
CZ Protiprašná maska s ventilom
H Eldobható porvédőmaszk, szelepes
RO Masca praf cu valva
E Mascarilla desechable para protección contra polvo
CN 带阀防尘面罩

3
PCS

FFP2 NR



POLYBAG
WITH HEADER



YT-7492



15/60

GB Disposable dust masks with valve
D Atemschutzmaske mit Ventil
PL Półmiski filtrujące jednorazowe z zaworem
RUS Респиратор противопылевой одноразовый с клапаном
CZ Protiprašná maska s ventilom
H Eldobható porvédőmaszk, szelepes
RO Masca praf cu valva
E Mascarilla desechable para protección contra polvo
CN 带阀防尘面罩

3
PCS

FFP2 NR



POLYBAG
WITH HEADER



YT-7494



15/60

GB Ear plugs
D Gehörschutz
PL Zatycki do uszu
RUS Средства защиты слуха

CZ Chrániče sluchu
H Fülvédőt
RO Antifoane

E Protectores de la vista
CN 耳塞



100 PCS



SNR 33 dB

| YATO | size / rozmiar (mm) | pairs / pary | |
|---------|---------------------|--------------|----|
| YT-7450 | 7-12 | 100 | 20 |



POLYBAG WITH HEADER

SNR 34 dB

| YATO | size / rozmiar (mm) | pairs / pary | |
|---------|---------------------|--------------|--------|
| YT-7451 | 7-12 | 5 | 25/500 |



200 PCS



SNR 34 dB

| YATO | size / rozmiar (mm) | pairs / pary | |
|----------|---------------------|--------------|----|
| YT-74510 | 7-12 | 200 | 20 |

GB Ear plugs
D Gehörschutz
PL Zatycki do uszu
RUS Средства защиты слуха

CZ Chrániče sluchu
H Fülvédőt
RO Antifoane

E Protectores de la vista
CN 耳塞



100 PCS



SNR 28 dB

| YATO | size / rozmiar (mm) | pairs / pary | |
|---------|---------------------|--------------|----|
| YT-7452 | 8-13 | 100 | 20 |



POLYBAG WITH HEADER

SNR 28 dB

| YATO | size / rozmiar (mm) | pairs / pary | |
|---------|---------------------|--------------|--------|
| YT-7453 | 8-13 | 5 | 25/500 |



50 PCS



SNR 22 dB

| YATO | size / rozmiar (mm) | pairs / pary | |
|---------|---------------------|--------------|----|
| YT-7454 | 8-12 | 50 | 20 |



POLYBAG WITH HEADER

SNR 22 dB

| YATO | size / rozmiar (mm) | pairs / pary | |
|---------|---------------------|--------------|--------|
| YT-7455 | 8-12 | 5 | 25/500 |

GB Ear plugs
D Gehörschutz
PL Zatycki do uszu na sznurku

RUS Средства защиты слуха
CZ Chrániče sluchu
H Fülvédőt

RO Antifoane
E Protectores de la vista
CN 耳塞



50 PCS



SNR 28 dB

| YATO | size / rozmiar (mm) | pairs / pary | |
|---------|---------------------|--------------|----|
| YT-7456 | 8-10 | 50 | 20 |

GB Ear plugs
D Gehörschutz
PL Zatycki do uszu na pałku
RUS Средства защиты слуха
CZ Chrániče sluchu
H Fülvédőt
RO Antifoane
E Protectores de la vista
CN 耳塞



POLYBAG WITH HEADER



SNR 21 dB

SNR 26 dB

| YATO | |
|---------|--------|
| YT-7458 | 25/500 |

| YATO | |
|---------|--------|
| YT-7459 | 25/500 |

GB Hearing protectors
D Gehörschutz
PL Nauszniki przeciwhalaszowe

RUS Средства защиты слуха
CZ Chrániče sluchu
H Fülvédőt

RO Antifoane
E Protectores de la vista
CN 耳罩

POLYBAG WITH HEADER



SNR 26 dB

| YATO | |
|---------|----|
| YT-7462 | 40 |



SNR 26 dB

| YATO | |
|---------|----|
| YT-7463 | 20 |



SNR 27 dB

| YATO | |
|----------|----|
| YT-74621 | 60 |

GB Low - cut safety shoes
D Arbeitshalbschuhe
PL Półbuty robocze
RUS Полуботинки рабочие
CZ Pracovní polobotky

H Munkavédelmi félcipő
RO Papuc de lucru
E Zapato de trabajo
CN 劳保鞋

CARTON BOX
WITH COLOR
LABEL



| YATO | size / rozmiar | |
|----------|----------------|----|
| YT-80552 | 39 | 10 |
| YT-80553 | 40 | 10 |
| YT-80554 | 41 | 10 |
| YT-80555 | 42 | 10 |
| YT-80556 | 43 | 10 |
| YT-80557 | 44 | 10 |
| YT-80558 | 45 | 10 |
| YT-80559 | 46 | 10 |
| YT-80560 | 47 | 10 |

| YATO | size / rozmiar | |
|----------|----------------|----|
| YT-80583 | 39 | 10 |
| YT-80584 | 40 | 10 |
| YT-80585 | 41 | 10 |
| YT-80586 | 42 | 10 |
| YT-80587 | 43 | 10 |
| YT-80588 | 44 | 10 |
| YT-80589 | 45 | 10 |
| YT-80590 | 46 | 10 |
| YT-80591 | 47 | 10 |



| YATO | size / rozmiar | |
|----------|----------------|----|
| YT-80572 | 39 | 10 |
| YT-80573 | 40 | 10 |
| YT-80574 | 41 | 10 |
| YT-80575 | 42 | 10 |
| YT-80576 | 43 | 10 |
| YT-80577 | 44 | 10 |
| YT-80578 | 45 | 10 |
| YT-80579 | 46 | 10 |
| YT-80580 | 47 | 10 |

| YATO | size / rozmiar | |
|----------|----------------|----|
| YT-80541 | 39 | 10 |
| YT-80542 | 40 | 10 |
| YT-80543 | 41 | 10 |
| YT-80544 | 42 | 10 |
| YT-80545 | 43 | 10 |
| YT-80546 | 44 | 10 |
| YT-80547 | 45 | 10 |
| YT-80548 | 46 | 10 |
| YT-80549 | 47 | 10 |

GB Middle - cut safety shoes
D Arbeitsschnürschuhe
PL Trzewiki robocze

RUS Ботинки рабочие
CZ Pracovní boty šněrovací
H Munkavédelmi bakancs

RO Pantof de lucru
E Calzado de trabajo
CN 劳保鞋

CARTON BOX
WITH COLOR
LABEL



| YATO | size / rozmiar | |
|----------|----------------|----|
| YT-80761 | 39 | 10 |
| YT-80762 | 40 | 10 |
| YT-80763 | 41 | 10 |
| YT-80764 | 42 | 10 |
| YT-80765 | 43 | 10 |
| YT-80766 | 44 | 10 |
| YT-80767 | 45 | 10 |
| YT-80768 | 46 | 10 |
| YT-80769 | 47 | 10 |

GB Low - cut safety shoes
 D Arbeitshalbschuhe
 PL Półbuty robocze
 RUS Полуботинки рабочие
 CZ Pracovní polobotky

H Munkavédelmi félcipő
 RO Papuc de lucru
 E Zapato de trabajo
 CN 劳保鞋

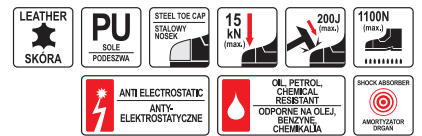

INSOLE & MESH COATED EVA
 WKŁADKA I WYSIÓŁKA Z MATERIAŁU EVA



TOLU

STEEL TOE CAP
 STALOWY NOSEK

PU SOLE
 PODESZWA Z POLIURETANU



INSOLE & MESH COATED EVA
 WKŁADKA I WYSIÓŁKA Z MATERIAŁU EVA



TRAT

STEEL TOE CAP
 STALOWY NOSEK

PU SOLE
 PODESZWA Z POLIURETANU



| YATO | size / rozmiar | |
|----------|----------------|----|
| YT-80794 | 39 | 10 |
| YT-80795 | 40 | 10 |
| YT-80796 | 41 | 10 |
| YT-80797 | 42 | 10 |
| YT-80798 | 43 | 10 |
| YT-80799 | 44 | 10 |
| YT-80800 | 45 | 10 |
| YT-80801 | 46 | 10 |
| YT-80802 | 47 | 10 |

| YATO | size / rozmiar | |
|----------|----------------|----|
| YT-80772 | 39 | 10 |
| YT-80773 | 40 | 10 |
| YT-80774 | 41 | 10 |
| YT-80775 | 42 | 10 |
| YT-80776 | 43 | 10 |
| YT-80777 | 44 | 10 |
| YT-80778 | 45 | 10 |
| YT-80779 | 46 | 10 |
| YT-80780 | 47 | 10 |

INSOLE & MESH COATED EVA
 WKŁADKA I WYSIÓŁKA Z MATERIAŁU EVA



TWER

STEEL TOE CAP
 STALOWY NOSEK

PU SOLE
 PODESZWA Z POLIURETANU



INSOLE & MESH COATED EVA
 WKŁADKA I WYSIÓŁKA Z MATERIAŁU EVA



ALBIT

STEEL TOE CAP
 STALOWY NOSEK

PU SOLE
 PODESZWA Z POLIURETANU



| YATO | size / rozmiar | |
|----------|----------------|----|
| YT-80783 | 39 | 10 |
| YT-80784 | 40 | 10 |
| YT-80785 | 41 | 10 |
| YT-80786 | 42 | 10 |
| YT-80787 | 43 | 10 |
| YT-80788 | 44 | 10 |
| YT-80789 | 45 | 10 |
| YT-80790 | 46 | 10 |
| YT-80791 | 47 | 10 |

| YATO | size / rozmiar | |
|----------|----------------|----|
| YT-80811 | 39 | 10 |
| YT-80812 | 40 | 10 |
| YT-80813 | 41 | 10 |
| YT-80814 | 42 | 10 |
| YT-80815 | 43 | 10 |
| YT-80816 | 44 | 10 |
| YT-80817 | 45 | 10 |
| YT-80818 | 46 | 10 |
| YT-80819 | 47 | 10 |

INSOLE & MESH COATED EVA
 WKŁADKA I WYSIÓŁKA Z MATERIAŁU EVA



ATAR

STEEL TOE CAP
 STALOWY NOSEK

PU SOLE
 PODESZWA Z POLIURETANU



INSOLE & MESH COATED EVA
 WKŁADKA I WYSIÓŁKA Z MATERIAŁU EVA



TEZU

STEEL TOE CAP
 STALOWY NOSEK

PU SOLE
 PODESZWA Z POLIURETANU



| YATO | size / rozmiar | |
|----------|----------------|----|
| YT-80823 | 39 | 10 |
| YT-80824 | 40 | 10 |
| YT-80825 | 41 | 10 |
| YT-80826 | 42 | 10 |
| YT-80827 | 43 | 10 |
| YT-80828 | 44 | 10 |
| YT-80829 | 45 | 10 |
| YT-80830 | 46 | 10 |
| YT-80831 | 47 | 10 |

| YATO | size / rozmiar | |
|----------|----------------|----|
| YT-80841 | 39 | 10 |
| YT-80842 | 40 | 10 |
| YT-80843 | 41 | 10 |
| YT-80844 | 42 | 10 |
| YT-80845 | 43 | 10 |
| YT-80846 | 44 | 10 |
| YT-80847 | 45 | 10 |
| YT-80848 | 46 | 10 |
| YT-80849 | 47 | 10 |



- GB Working jacket
D Arbeitsjacke
PL Bluza robocza
RUS Рабочая рубашка
CZ Pracovní blůza
- H Munkaruha felső
RO Bluză de lucru
E Blusa de trabajo
CN 工作服

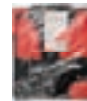

65% POLYESTER
35% COTTON
65% POLYESTER
35% BAWELNA

POLYBAG



| YATO  | size / rozmiar |  |
|--|----------------|---|
| YT-8020 | S | 20 |
| YT-8021 | M | 20 |
| YT-8022 | L | 20 |
| YT-8023 | XL | 20 |
| YT-8024 | XXL | 20 |



- GB Working trousers
D Arbeitshosen
PL Spodnie robocze
RUS Рабочие брюки
CZ Pracovní kalhoty
H Munkaruha nadrág
RO Pantaloni de lucru
E Pantalón de trabajo
CN 工作服



65% POLYESTER
35% COTTON
65% POLYESTER
35% BAWELNA

POLYBAG



| YATO  | size / rozmiar |  |
|--|----------------|---|
| YT-8025 | S | 20 |
| YT-8026 | M | 20 |
| YT-8027 | L | 20 |
| YT-8028 | XL | 20 |
| YT-8029 | XXL | 20 |



- GB Working overalls
D Arbeitshosen, Gärtnerin
PL Spodnie robocze ogrodniczki
RUS Рабочий полукombineзон
CZ Pracovní kalhoty lačlové
H Kertész nadrág
RO Pantaloni de lucru grădină
E Pantalón de trabajo tipo jardinero
CN 工作服



65% POLYESTER
35% COTTON
65% POLYESTER
35% BAWELNA

POLYBAG



| YATO  | size / rozmiar |  |
|--|----------------|---|
| YT-8030 | S | 20 |
| YT-8031 | M | 20 |
| YT-8032 | L | 20 |
| YT-8033 | XL | 20 |
| YT-8034 | XXL | 20 |

21

Electric products Artykuły elektryczne



LED bulbs
Żarówki LED

360



LED workshop lighting
Oświetlenie warsztatowe LED

363-364



LED lamps
Reflektory LED

361-362



Extension cords
Przedłużacze elektryczne

365



GB LED light bulb
 D LED- Glühlampe
 PL Żarówka LED
 RUS Светодиодная лампочка
 CZ LED žárovka
 H LED égő
 RO Bec LED
 E Bombilla LED
 CN LED灯泡

E27

7W **10W** **12W**

590 lm **720 lm** **950 lm**

40W REPLACEMENT ODPOWIEDNIK
 60W REPLACEMENT ODPOWIEDNIK
 75W REPLACEMENT ODPOWIEDNIK

WHITE WARM BIAŁY CIEPŁY
 230V~ 50Hz

LED



PVC COLOR BOX

| YATO | W | lm | replacement / odpowiednik (W) | |
|----------|----|-----|-------------------------------|-----|
| YT-81851 | 7 | 590 | 40 | 100 |
| YT-81852 | 10 | 720 | 60 | 100 |
| YT-81853 | 12 | 950 | 75 | 100 |

GB LED light bulb
 D LED- Glühlampe
 PL Żarówka LED
 RUS Светодиодная лампочка
 CZ LED žárovka
 H LED égő
 RO Bec LED
 E Bombilla LED
 CN LED灯泡

GU10

5W **250 lm**

25W REPLACEMENT ODPOWIEDNIK
 3000K CRI>80

WHITE WARM BIAŁY CIEPŁY
 230V~ 50Hz

LED



PVC COLOR BOX

| YATO | W | lm | replacement / odpowiednik (W) | |
|----------|---|-----|-------------------------------|-----|
| YT-81861 | 5 | 250 | 25 | 200 |

GB LED light bulb
 D LED- Glühlampe
 PL Żarówka LED
 RUS Светодиодная лампочка
 CZ LED žárovka
 H LED égő
 RO Bec LED
 E Bombilla LED
 CN LED灯泡

MR16 U U

5W **265 lm**

25W REPLACEMENT ODPOWIEDNIK
 3000K CRI>80

WHITE WARM BIAŁY CIEPŁY
 12V AC/DC

LED



PVC COLOR BOX

| YATO | W | lm | replacement / odpowiednik (W) | |
|----------|---|-----|-------------------------------|-----|
| YT-81862 | 5 | 265 | 25 | 200 |

GB LED light bulb
 D LED- Glühlampe
 PL Żarówka LED
 RUS Светодиодная лампочка
 CZ LED žárovka
 H LED égő
 RO Bec LED
 E Bombilla LED
 CN LED灯泡

E14

3W **160 lm**

20W REPLACEMENT ODPOWIEDNIK
 3000K CRI>80

WHITE WARM BIAŁY CIEPŁY
 230V~ 50Hz

LED



PVC COLOR BOX

| YATO | W | lm | replacement / odpowiednik (W) | |
|----------|---|-----|-------------------------------|-----|
| YT-81871 | 3 | 160 | 20 | 100 |

GB LED lamp
D Diodenscheinwerfer
PL Reflektor diodowy
RUS Светодиодный прожектор
CZ LED reflektor
H Diódás reflektor
RO Reflector diodă
E Reflector de diodos
CN 工作灯

10W **6000°K**
~220-240V
50Hz **700**
lm
IP65
20000 h

LED

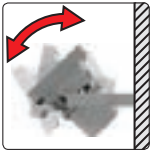

YATO
YT-81800 18

COLOR BOX

GB LED lamp with motion detector
D Diodenscheinwerfer mit Bewegungsmelder
PL Reflektor diodowy z czujnikiem ruchu
RUS Светодиодный прожектор с датчиком движения
CZ LED reflektor se snímačem pohybu
H Diódás reflektor mozgásérzékelővel
RO Reflector diodă cu senzor de mișcare
E Reflector de diodos con sensor de movimiento
CN 工作灯

10W **6000°K**
~220-240V
50Hz **700**
lm
IP44
20000 h

LED

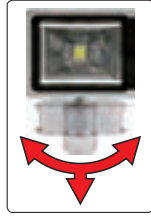

YATO
YT-81801 18

COLOR BOX

GB Portable LED lamp
D Diodenscheinwerfer, mit Tragebügel
PL Reflektor diodowy przenośny
RUS Светодиодный прожектор переносной
CZ LED reflektor přenosný
H Hordozható, diódás reflektor
RO Reflector diodă portabil
E Reflector de diodos portátil
CN 手提式工作灯

10W **6000°K**
~220-240V
50Hz **700**
lm
IP65
20000 h

LED

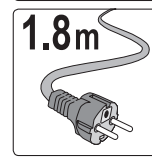

YATO
YT-81802 12

COLOR BOX

GB LED lamp
D Diodenscheinwerfer
PL Reflektor diodowy
RUS Светодиодный прожектор
CZ LED reflektor
H Diódás reflektor
RO Reflector diodă
E Reflector de diodos
CN 工作灯

30W **6000°K** ~220-240V
50Hz **2100**
lm **IP65**
20000 h

LED

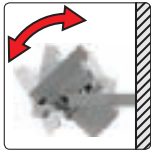

YATO
YT-81803 6

COLOR BOX

GB LED lamp with motion detector
D Diodenscheinwerfer mit Bewegungsmelder
PL Reflektor diodowy z czujnikiem ruchu
RUS Светодиодный прожектор с датчиком движения
CZ LED reflektor se snímačem pohybu
H Diódás reflektor mozgásérzékelővel
RO Reflector diodă cu senzor de mișcare
E Reflector de diodos con sensor de movimiento
CN 工作灯

30W **6000°K** ~220-240V
50Hz **2100**
lm **IP44**
20000 h

LED

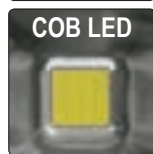
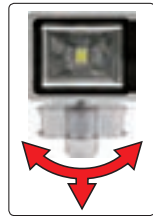

YATO
YT-81804 6

COLOR BOX

GB Portable handle for LED floodlight
D Tragbare Ständer für LED-Lampen
PL Uchwyt do reflektora LED
RUS Портативная подставка для светодиодных ламп
CZ Přenosný stojan LED světometů
H Hordozható állvány LED fényzóró
RO Suport portabil faruri cu LED-uri
E Soporte portátil linterna LED
CN 灯手柄

WHITE BOX WITH COLOUR LABEL



for / dla: YT-81803



YATO
YT-81805 8

GB LED lamp
D Diodenscheinwerfer
PL Reflektor diodowy
RUS Светодиодный прожектор
CZ LED reflektor
H Diódás reflektor
RO Reflector diodă
E Reflector de diodos
CN 工作灯

50W **3500** **6000°K** ~220-240V
lm **IP65**
20000 h

LED

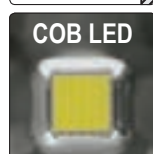
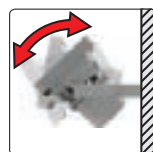

YATO
YT-81806 3

COLOR BOX

GB LED lamp
 D Diodenscheinwerfer
 PL Reflektor diodowy
 RUS Светодиодный прожектор
 CZ LED reflektor
 H Diódás reflektor
 RO Reflector diodă
 E Reflector de diodos
 CN 工作灯

COLOR BOX



~220-240V
50Hz

6W

6 LED

HIGH POWER LED
1W
DIODA DUŻEJ MOCY

510 lm

30 000-50 000 h

IP54



LOW ENERGY CONSUMPTION
NISKIE ZUŻYCIE ENERGII

YATO
YT-81790 24

GB LED lamp with motion detector
 D Diodenscheinwerfer mit Bewegungsmelder
 PL Reflektor diodowy z czujnikiem ruchu
 RUS Светодиодный прожектор с датчиком движения
 CZ LED reflektor se snímačem pohybu
 H Diódás reflektor mozgásérzékelővel
 RO Reflector diodă cu senzor de mişcare
 E Reflector de diodos con sensor de movimiento
 CN 工作灯

COLOR BOX



~220-240V
50Hz

6W

6 LED

HIGH POWER LED
1W
DIODA DUŻEJ MOCY

510 lm

30 000-50 000 h

IP44



LOW ENERGY CONSUMPTION
NISKIE ZUŻYCIE ENERGII

MOTION DETECTOR
CZUJNIK RUCHU

YATO
YT-81791 18

GB Portable LED lamp
 D Diodenscheinwerfer, mit Tragebügel
 PL Reflektor diodowy przenośny
 RUS Светодиодный прожектор переносной
 CZ LED reflektor přenosný
 H Hordozható, diódás reflektor
 RO Reflector diodă portabil
 E Reflector de diodos portátil
 CN 手提式工作灯

COLOR BOX



~220-240V
50Hz

6W

6 LED

HIGH POWER LED
1W
DIODA DUŻEJ MOCY

510 lm

30 000-50 000 h

IP54



LOW ENERGY CONSUMPTION
NISKIE ZUŻYCIE ENERGII

YATO
YT-81792 12

GB LED lamp
 D Diodenscheinwerfer
 PL Reflektor diodowy
 RUS Светодиодный прожектор
 CZ LED reflektor
 H Diódás reflektor
 RO Reflector diodă
 E Reflector de diodos
 CN 工作灯

COLOR BOX



~220-240V
50Hz

12W

12 LED

HIGH POWER LED
1W
DIODA DUŻEJ MOCY

1020 lm

30 000-50 000 h

IP54



LOW ENERGY CONSUMPTION
NISKIE ZUŻYCIE ENERGII

YATO
YT-81793 16

GB LED lamp with motion detector
 D Diodenscheinwerfer mit Bewegungsmelder
 PL Reflektor diodowy z czujnikiem ruchu
 RUS Светодиодный прожектор с датчиком движения
 CZ LED reflektor se snímačem pohybu
 H Diódás reflektor mozgásérzékelővel
 RO Reflector diodă cu senzor de mişcare
 E Reflector de diodos con sensor de movimiento
 CN 工作灯

COLOR BOX



~220-240V
50Hz

12W

12 LED

HIGH POWER LED
1W
DIODA DUŻEJ MOCY

1020 lm

30 000-50 000 h

IP44



LOW ENERGY CONSUMPTION
NISKIE ZUŻYCIE ENERGII

MOTION DETECTOR
CZUJNIK RUCHU

YATO
YT-81794 12

GB Portable LED lamp
 D Diodenscheinwerfer, mit Tragebügel
 PL Reflektor diodowy przenośny
 RUS Светодиодный прожектор переносной
 CZ LED reflektor přenosný
 H Hordozható, diódás reflektor
 RO Reflector diodă portabil
 E Reflector de diodos portátil
 CN 手提式工作灯

COLOR BOX



~220-240V
50Hz

12W

12 LED

HIGH POWER LED
1W
DIODA DUŻEJ MOCY

1020 lm

30 000-50 000 h

IP54



LOW ENERGY CONSUMPTION
NISKIE ZUŻYCIE ENERGII

YATO
YT-81795 8

GB Rechargeable work lamp
D Led Werkstattlampe
PL Diodowa lampa bezprzewodowa
RUS Светодиодная беспроводная лампа
CZ Montážní lampa diodová bezpřívodová
H Ledlámpa
RO Lampa cu led fara cablu
E Lámpara inalámbrica de diodos
CN 可充电工作灯

| | |
|--|------------------------------------|
| 230V~50Hz BATTERY CHARGER ŁADOWNIK | 30 LED |
| 4.8V 3300mAh Ni-MH | 8-10 h |
| BATTERY CHARGER ŁADOWNIK | SHOCK PROOF ODPORNA NA WSTRZĄSY |
| OIL PROOF ODPORNA NA OLEJ | WATER PROOF ODPORNA NA WODĘ |



YATO  
YT-0850 3/6

GB Rechargeable work lamp
D Led Werkstattlampe
PL Diodowa lampa bezprzewodowa
RUS Светодиодная беспроводная лампа
CZ Montážní lampa diodová bezpřívodová
H Ledlámpa
RO Lampa cu led fara cablu
E Lámpara inalámbrica de diodos
CN 可充电工作灯

| | |
|------------------------------------|---|
| 21+5 LED | 3 POSITION POZYCJE |
| 3.6V 1800mAh Ni-MH | 230V~50Hz BATTERY CHARGER ŁADOWNIK |
| 21 LED 4-5h | 5 LED 10h |
| WATER PROOF ODPORNA NA WODĘ | OVERLOAD PROTECTION ZABEZPIECZENIE PRZEŁADOWANIA |
| SHOCK PROOF ODPORNA NA WSTRZĄSY | OIL PROOF ODPORNA NA OLEJ |
| | SHORTAGE PROTECTION ZABEZPIECZENIE PRZECIWDROBOWIE |



YATO  
YT-0851 20

GB Rechargeable work lamp
D Led Werkstattlampe
PL Diodowa lampa warsztatowa
RUS Светодиодная беспроводная лампа
CZ Montážní lampa diodová bezpřívodová
H Ledlámpa
RO Lampa cu led fara cablu
E Lámpara inalámbrica de diodos
CN 可充电工作灯

| | |
|--------------------------------|--|
| 27 LED | 13000 MCD |
| 3.6V 1200mAh Ni-MH | 230V~50Hz BATTERY CHARGER ŁADOWNIK |
| 4 h | CHARGING TIME CZAS ŁADOWANIA 4 h |
| WATER PROOF ODPORNA NA WODĘ | MAGNETIC |



YATO  
YT-0852 10

GB Rechargeable work lamp
 D Led Werkstattlampe
 PL Diodowa lampa warsztatowa
 RUS Светодиодная беспроводная лампа
 CZ Montážní lampa diodová bezpřívodová
 H Ledlámpa
 RO Lampă cu led fara cablu
 E Lámpara inalámbrica de diodos
 CN 可充电工作灯

| | |
|---|--|
| 30/7 LED | 13000 MCD |
| 3.6V 1200mAh NI-MH | 230V~50Hz BATTERY CHARGER LADOVARKA |
| 15 h (7 LED) | 4 h (30 LED) |
| CHARGING TIME CZAS LADOWANIA 4-5 h | |

GB Rechargeable work lamp
 D Led Werkstattlampe
 PL Diodowa lampa warsztatowa
 RUS Светодиодная беспроводная лампа
 CZ Montážní lampa diodová bezpřívodová
 H Ledlámpa
 RO Lampă cu led fara cablu
 E Lámpara inalámbrica de diodos
 CN 可充电伸缩工作灯

| | |
|---|--|
| 30/6 LED | 13000 MCD |
| 3.6V 1000mAh NI-MH | 230V~50Hz BATTERY CHARGER LADOVARKA |
| 10 h (6 LED) | 3 h (30 LED) |
| CHARGING TIME CZAS LADOWANIA 3-4 h | |

GB Rechargeable work lamp
 D Led Werkstattlampe
 PL Diodowa lampa warsztatowa
 RUS Светодиодная беспроводная лампа
 CZ Montážní lampa diodová bezpřívodová
 H Ledlámpa
 RO Lampă cu led fara cablu
 E Lámpara inalámbrica de diodos
 CN 可充电工作灯

| | |
|---|--|
| 60+1 LED | 13000 MCD |
| 7.2V 800mAh NI-MH | 230V~50Hz BATTERY CHARGER LADOVARKA |
| 4 h | |
| CHARGING TIME CZAS LADOWANIA 4-5 h | |



COLOR BOX



COLOR BOX



DOUBLE BLISTER

YATO
 YT-08505 10

YATO
 YT-08512 12

YATO
 YT-0852 5/20

GB Under bonnet work led lamp
 D Led Werkstattlampe
 PL Diodowa lampa warsztatowa do oświetlenia komory silnika
 RUS Светодиодная беспроводная лампа
 CZ Montážní lampa diodová bezpřívodová
 H Ledlámpa
 RO Lampă cu led fara cablu
 E Lámpara inalámbrica de diodos
 CN 引擎盖检修灯



| | |
|---|--|
| 120 LED | 13000 MCD |
| 7.2V 1800mAh NI-MH | 230V~50Hz BATTERY CHARGER LADOVARKA |
| 60 LED | 120 LED |
| 8 h (60 LED) | 4 h (120 LED) |
| CHARGING TIME CZAS LADOWANIA 4-5 h | |

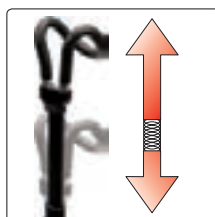
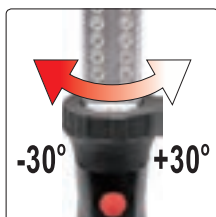

YATO
 YT-08530 4

COLOR BOX

GB Extension cord
D Verlängerungskabel
PL Przedłużacz elektryczny
RUS Удлинитель электрический
CZ Elektrický prodloužovač
H Elektromos hosszabbító
RO Prelungitor electric
E Extensión electr.
CN 电缆延长线

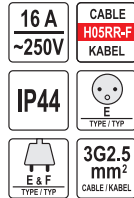

COLOR BOX

| YATO | L (m) | |
|---------|-------|---|
| YT-8100 | 20 | 4 |
| YT-8101 | 30 | 2 |
| YT-8102 | 40 | 2 |

GB Rubber protection extension cord
D Gummiisolierte Verlängerungsschnur
PL Przedłużacz w osłonie gumowej
RUS Удлинитель с резиновой изоляцией
CZ Prodloužovací kabel s gumovou izolací
H Gumi szigetelésű hosszabbító
RO Cablu prelungitor cauciuc
E Cable de extensi3n con protecci3n de caucho
CN 电缆延长线

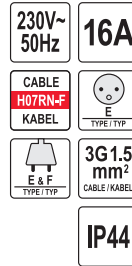

| YATO | L (m) | |
|---------|-------|----|
| YT-8110 | 2 | 40 |
| YT-8111 | 5 | 16 |
| YT-8112 | 10 | 8 |

GB Rubber protection extension cord
D Gummiisolierte Verlängerungsschnur
PL Przedłużacz w osłonie gumowej
RUS Удлинитель с резиновой изоляцией
CZ Prodloužovací kabel s gumovou izolací
H Gumi szigetelésű hosszabbító
RO Cablu prelungitor cauciuc
E Cable de extensi3n con protecci3n de caucho
CN 电缆延长线

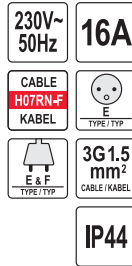

| YATO | L (m) | |
|---------|-------|----|
| YT-8115 | 2 | 10 |
| YT-8116 | 10 | 4 |

GB Cable reel
D Kabeltrommel
PL Przedłużacz zwijany
RUS Удлинитель электрический
CZ Bubnový prodloužovač
H Kábeldob
RO Prelungitor pe tambur
E Cable de prolongaci3n de tambor
CN 电缆延长线

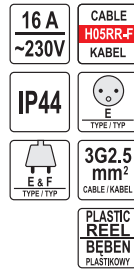

• $P_{max} = 1200$ W coiled
 $P_{max} = 1200$ W zwinięty
• $P_{max} = 3600$ W uncoiled
 $P_{max} = 3600$ W rozwinięty

| YATO | L (m) | |
|---------|-------|---|
| YT-8106 | 30 | 1 |
| YT-8107 | 40 | 1 |
| YT-8108 | 50 | 1 |

GB Drum power extension cord
D Verlängerungstrommel für Kraftstrom
PL Przedłużacz bębnowy siłowy
RUS Силовый удлинитель барабанного типа
CZ Prodloužovací kabel silový na bubnu
H Háromfázisú hosszabbító dob
RO Derulator cu tambur
E Cilindro de extensi3n de fuerza
CN 电缆延长线

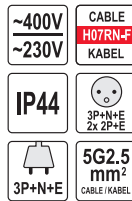

• ~230V; 2P+E
 $P_{max} = 1200$ W coiled
 $P_{max} = 1200$ W zwinięty
 $P_{max} = 3000$ W uncoiled
 $P_{max} = 3000$ W rozwinięty

• ~400V; 3P+N+E
 $P_{max} = 3000$ W coiled
 $P_{max} = 3000$ W zwinięty
 $P_{max} = 9000$ W uncoiled
 $P_{max} = 9000$ W rozwinięty

| YATO | L (m) | |
|---------|-------|---|
| YT-8120 | 25 | 1 |

| YATO | page/strom | YATO | page/strom | YATO | page/strom | YATO | page/strom | YATO | page/strom | YATO | page/strom | YATO | page/strom |
|----------|------------|----------|------------|----------|------------|---------|------------|----------|------------|----------|------------|---------|------------|
| YT-2260 | 138 | YT-2453 | 125 | YT-25862 | 95 | YT-2621 | 84 | YT-2741 | 93 | YT-2865 | 322 | YT-2983 | 170 |
| YT-2261 | 138 | YT-2459 | 125 | YT-25863 | 95 | YT-2622 | 84 | YT-2742 | 93 | YT-2866 | 322 | YT-2984 | 170 |
| YT-2262 | 138 | YT-2460 | 125 | YT-25900 | 89 | YT-2623 | 84 | YT-2743 | 93 | YT-28950 | 166 | YT-2985 | 170 |
| YT-2263 | 138 | YT-2461 | 126 | YT-25901 | 89 | YT-2624 | 84 | YT-2744 | 93 | YT-28951 | 166 | YT-2986 | 170 |
| YT-2264 | 138 | YT-2463 | 126 | YT-25902 | 89 | YT-2625 | 84 | YT-2745 | 93 | YT-28952 | 166 | YT-2987 | 170 |
| YT-2266 | 135 | YT-2466 | 126 | YT-25903 | 89 | YT-2626 | 84 | YT-2746 | 93 | YT-28953 | 166 | YT-2988 | 170 |
| YT-2267 | 135 | YT-2468 | 126 | YT-25904 | 89 | YT-2627 | 84 | YT-2748 | 93 | YT-28954 | 166 | YT-2989 | 170 |
| YT-2268 | 137 | YT-2469 | 126 | YT-25905 | 89 | YT-2628 | 84 | YT-2750 | 93 | YT-28955 | 166 | YT-2990 | 170 |
| YT-2270 | 137 | YT-2473 | 126 | YT-25906 | 89 | YT-2629 | 84 | YT-2752 | 93 | YT-28956 | 166 | YT-2991 | 170 |
| YT-2271 | 135 | YT-2476 | 126 | YT-25907 | 89 | YT-2630 | 84 | YT-2753 | 93 | YT-28957 | 166 | YT-2992 | 170 |
| YT-2272 | 136 | YT-2482 | 128; 208 | YT-25908 | 89 | YT-2631 | 84 | YT-2754 | 93 | YT-28958 | 166 | YT-2993 | 170 |
| YT-2273 | 136 | YT-2483 | 128; 208 | YT-25909 | 89 | YT-2633 | 93 | YT-2756 | 93 | YT-28959 | 166 | YT-2994 | 170 |
| YT-2274 | 137 | YT-2484 | 128; 208 | YT-25910 | 89 | YT-2634 | 93 | YT-2757 | 93 | YT-28960 | 166 | YT-2995 | 170 |
| YT-2275 | 137 | YT-2485 | 128; 208 | YT-25911 | 89 | YT-2635 | 93 | YT-2760 | 84 | YT-28961 | 166 | YT-2996 | 170 |
| YT-2276 | 137 | YT-2488 | 128; 208 | YT-25912 | 89 | YT-2636 | 93 | YT-2761 | 84 | YT-28962 | 166 | YT-2997 | 170 |
| YT-2277 | 135 | YT-2489 | 128; 208 | YT-25913 | 89 | YT-2637 | 93 | YT-2762 | 84 | YT-28963 | 166 | YT-3001 | 248 |
| YT-2278 | 137 | YT-2490 | 128; 208 | YT-25914 | 89 | YT-2638 | 93 | YT-2763 | 84 | YT-28964 | 166 | YT-3002 | 248 |
| YT-2279 | 138 | YT-2491 | 128; 208 | YT-25920 | 89 | YT-2639 | 93 | YT-2764 | 84 | YT-28965 | 166 | YT-3003 | 248 |
| YT-2280 | 138 | YT-2492 | 128; 208 | YT-25921 | 89 | YT-2640 | 93 | YT-2765 | 84 | YT-28966 | 166 | YT-3004 | 248 |
| YT-2283 | 133 | YT-2493 | 128; 208 | YT-25922 | 89 | YT-2641 | 93 | YT-2766 | 84 | YT-28967 | 166 | YT-3005 | 248 |
| YT-22860 | 134 | YT-2494 | 128; 208 | YT-25923 | 89 | YT-2642 | 93 | YT-2767 | 84 | YT-2900 | 208 | YT-3022 | 248 |
| YT-22861 | 134 | YT-2495 | 128; 208 | YT-25924 | 89 | YT-2643 | 93 | YT-2768 | 84 | YT-2910 | 208 | YT-3023 | 248 |
| YT-22862 | 134 | YT-2510 | 279 | YT-25925 | 89 | YT-2644 | 93 | YT-2769 | 84 | YT-2911 | 208 | YT-3024 | 248 |
| YT-22870 | 181 | YT-25105 | 279 | YT-25926 | 89 | YT-2645 | 93 | YT-2770 | 84 | YT-2912 | 208 | YT-3025 | 248 |
| YT-22871 | 181 | YT-2511 | 278 | YT-25927 | 89 | YT-2647 | 93 | YT-2771 | 84 | YT-2913 | 208 | YT-3026 | 248 |
| YT-22872 | 181 | YT-2512 | 278 | YT-25928 | 89 | YT-2648 | 93 | YT-2772 | 84 | YT-2914 | 208 | YT-3071 | 235 |
| YT-22873 | 181 | YT-2513 | 278 | YT-25929 | 89 | YT-2649 | 93 | YT-2773 | 84 | YT-2916 | 208 | YT-3072 | 235 |
| YT-22874 | 181 | YT-2514 | 278 | YT-25930 | 89 | YT-2650 | 93 | YT-2774 | 84 | YT-2917 | 208 | YT-3073 | 235 |
| YT-22875 | 181 | YT-2515 | 278 | YT-25931 | 89 | YT-2651 | 93 | YT-2775 | 84 | YT-2918 | 208 | YT-3074 | 235 |
| YT-2290 | 136 | YT-2516 | 278 | YT-25932 | 89 | YT-2653 | 93 | YT-2776 | 84 | YT-2919 | 208 | YT-3076 | 235 |
| YT-2292 | 136 | YT-2517 | 278 | YT-25933 | 89 | YT-2654 | 93 | YT-2777 | 84 | YT-2920 | 208 | YT-3077 | 235 |
| YT-2293 | 136 | YT-2518 | 278 | YT-25934 | 89 | YT-2655 | 93 | YT-2778 | 84 | YT-2921 | 208 | YT-3078 | 235 |
| YT-22930 | 136 | YT-2519 | 278 | YT-25940 | 89 | YT-2656 | 93 | YT-2779 | 84 | YT-2926 | 169 | YT-3079 | 235 |
| YT-2294 | 136 | YT-2520 | 278 | YT-25941 | 89 | YT-2657 | 93 | YT-2780 | 98 | YT-2927 | 169 | YT-3081 | 235 |
| YT-2295 | 136 | YT-2521 | 278 | YT-25942 | 89 | YT-2658 | 93 | YT-2781 | 87 | YT-2928 | 169 | YT-3082 | 235 |
| YT-2296 | 132 | YT-2522 | 278 | YT-25943 | 89 | YT-2661 | 93 | YT-2782 | 86 | YT-2929 | 169 | YT-3083 | 235 |
| YT-2297 | 132 | YT-2523 | 278 | YT-25950 | 89 | YT-2663 | 93 | YT-2783 | 86 | YT-2930 | 169 | YT-3084 | 235 |
| YT-2298 | 132 | YT-2535 | 312 | YT-25951 | 89 | YT-2665 | 93 | YT-2784 | 86 | YT-2931 | 169 | YT-3101 | 182 |
| YT-2299 | 132 | YT-2536 | 312 | YT-25952 | 89 | YT-2667 | 93 | YT-2785 | 87 | YT-2932 | 169 | YT-3102 | 182 |
| YT-2300 | 133 | YT-2537 | 312 | YT-25953 | 89 | YT-2668 | 94 | YT-2786 | 87 | YT-2933 | 169 | YT-3103 | 182 |
| YT-2301 | 133 | YT-2538 | 307 | YT-25954 | 89 | YT-2669 | 94 | YT-2787 | 86 | YT-2934 | 169 | YT-3106 | 182 |
| YT-2302 | 133 | YT-2539 | 281 | YT-25955 | 89 | YT-2670 | 94 | YT-2788 | 86 | YT-2935 | 169 | YT-3107 | 182 |
| YT-2305 | 134 | YT-2540 | 281 | YT-25956 | 89 | YT-2675 | 84 | YT-2789 | 87 | YT-2937 | 169 | YT-3108 | 182 |
| YT-2307 | 133 | YT-2541 | 281 | YT-25957 | 89 | YT-2676 | 84 | YT-2790 | 88 | YT-2939 | 169 | YT-3130 | 182 |
| YT-2313 | 137 | YT-2542 | 282 | YT-25958 | 89 | YT-2677 | 84 | YT-2791 | 88 | YT-2940 | 169 | YT-3133 | 182 |
| YT-2316 | 137 | YT-2543 | 282 | YT-25959 | 89 | YT-2678 | 84 | YT-2795 | 88 | YT-2941 | 169 | YT-3134 | 182 |
| YT-2319 | 136 | YT-2544 | 312 | YT-25960 | 89 | YT-2679 | 84 | YT-2797 | 97 | YT-2942 | 169 | YT-3150 | 182 |
| YT-2340 | 257 | YT-2545 | 280 | YT-25961 | 89 | YT-2682 | 84 | YT-2798 | 97 | YT-2943 | 169 | YT-3160 | 183 |
| YT-2341 | 257 | YT-2546 | 312 | YT-25965 | 90 | YT-2683 | 84 | YT-2799 | 98 | YT-2944 | 169 | YT-3161 | 183 |
| YT-2346 | 257 | YT-2547 | 312 | YT-25966 | 91 | YT-2686 | 84 | YT-2800 | 99 | YT-2945 | 169 | YT-3163 | 183 |
| YT-2357 | 257 | YT-2571 | 98 | YT-25967 | 91 | YT-2687 | 84 | YT-2801 | 99 | YT-2946 | 169 | YT-3200 | 182 |
| YT-2361 | 257 | YT-2575 | 88 | YT-25968 | 92 | YT-2688 | 84 | YT-2802 | 99 | YT-2947 | 169 | YT-3201 | 182 |
| YT-2364 | 257 | YT-2576 | 88 | YT-25971 | 91 | YT-2689 | 84 | YT-2804 | 97 | YT-2948 | 169 | YT-3202 | 182 |
| YT-2370 | 257 | YT-2577 | 88 | YT-25972 | 98 | YT-2690 | 84 | YT-2806 | 99 | YT-2949 | 169 | YT-3203 | 182 |
| YT-2371 | 257 | YT-25802 | 95 | YT-25980 | 90 | YT-2691 | 84 | YT-2808 | 97 | YT-2950 | 169 | YT-3204 | 182 |
| YT-2372 | 257 | YT-25803 | 95 | YT-25981 | 91 | YT-2692 | 84 | YT-2810 | 100 | YT-2951 | 169 | YT-3220 | 183 |
| YT-2373 | 258 | YT-25804 | 95 | YT-25982 | 92 | YT-2693 | 84 | YT-2811 | 100 | YT-2952 | 169 | YT-3221 | 183 |
| YT-2374 | 258 | YT-25805 | 95 | YT-25985 | 90 | YT-2694 | 84 | YT-2812 | 100 | YT-2953 | 169 | YT-3222 | 183 |
| YT-2375 | 258 | YT-25806 | 95 | YT-25986 | 90 | YT-2699 | 85 | YT-2815 | 96 | YT-2954 | 169 | YT-3223 | 183 |
| YT-2376 | 258 | YT-25807 | 95 | YT-25987 | 90 | YT-2700 | 85 | YT-2816 | 96 | YT-2955 | 169 | YT-3224 | 183 |
| YT-2380 | 259 | YT-25808 | 95 | YT-25988 | 90 | YT-2701 | 85 | YT-2817 | 96 | YT-2956 | 169 | YT-3225 | 183 |
| YT-2381 | 259 | YT-25809 | 95 | YT-25989 | 90 | YT-2702 | 85 | YT-2818 | 96 | YT-2957 | 169 | YT-3230 | 183 |
| YT-2382 | 259 | YT-25810 | 95 | YT-25990 | 90 | YT-2703 | 85 | YT-2819 | 96 | YT-2958 | 169 | YT-3231 | 183 |
| YT-2383 | 259 | YT-25811 | 95 | YT-25991 | 90 | YT-2704 | 85 | YT-2820 | 96 | YT-2959 | 169 | YT-3232 | 183 |
| YT-2384 | 259 | YT-25831 | 95 | YT-25992 | 90 | YT-2705 | 85 | YT-2821 | 96 | YT-2960 | 170 | YT-3233 | 183 |
| YT-2385 | 259 | YT-25832 | 95 | YT-25993 | 90 | YT-2706 | 85 | YT-2822 | 96 | YT-2961 | 170 | YT-3234 | 183 |
| YT-2390 | 259 | YT-25833 | 95 | YT-25994 | 90 | YT-2708 | 85 | YT-2823 | 96 | YT-2962 | 170 | YT-3236 | 164 |
| YT-2391 | 259 | YT-25834 | 95 | YT-25995 | 90 | YT-2709 | 85 | YT-2824 | 96 | YT-2963 | 170 | YT-3237 | 164 |
| YT-2392 | 259 | YT-25835 | 95 | YT-25996 | 90 | YT-2710 | 85 | YT-2825 | 96 | YT-2964 | 170 | YT-3238 | 164 |
| YT-2393 | 259 | YT-25836 | 95 | YT-25997 | 90 | YT-2711 | 85 | YT-2826 | 96 | YT-2965 | 170 | YT-3239 | 164 |
| YT-2394 | 259 | YT-25837 | 95 | YT-25998 | 90 | YT-2712 | 85 | YT-2827 | 96 | YT-2966 | 170 | YT-3240 | 164 |
| YT-2395 | 259 | YT-25838 | 95 | YT-2601 | 93 | YT-2715 | 84 | YT-2828 | 96 | YT-2967 | 170 | YT-3241 | 164 |
| YT-2396 | 259 | YT-25839 | 95 | YT-2602 | 93 | YT-2716 | 84 | YT-2830 | 139 | YT-2968 | 170 | YT-3242 | 164 |
| YT-2397 | 259 | YT-25840 | 95 | YT-2603 | 93 | YT-2717 | 84 | YT-2840 | 85 | YT-2969 | 170 | YT-3243 | 164 |
| YT-2398 | 259 | YT-25841 | 95 | YT-2604 | 93 | YT-2718 | 84 | YT-2841 | 85 | YT-2970 | 170 | YT-3244 | 164 |
| YT-2399 | 259 | YT-25842 | 95 | YT-2606 | 93 | YT-2719 | 84 | YT-2842 | 85 | YT-2971 | 170 | YT-3245 | 164 |
| YT-2401 | 259 | YT-25843 | 95 | YT-2607 | 93 | YT-2721 | 84 | YT-2843 | 85 | YT-2972 | 170 | YT-3246 | 164 |
| YT-2402 | 259 | YT-25844 | 95 | YT-2608 | 93 | YT-2722 | 84 | YT-2844 | 85 | YT-2973 | 170 | YT-3247 | 164 |
| YT-2403 | 259 | YT-25845 | 95 | YT-2609 | 93 | YT-2723 | 84 | YT-2845 | 85 | YT-2974 | 170 | YT-3248 | 164 |
| YT-2404 | 259 | YT-25846 | 95 | YT-2610 | 93 | YT-2725 | 84 | YT-2846 | 85 | YT-2975 | 169 | YT-3249 | 164 |
| YT-2405 | 259 | YT-25852 | 95 | YT-2612 | 93 | YT-2727 | 84 | YT-2847 | 85 | YT-2976 | 170 | YT-3250 | 164 |
| YT-2406 | 259 | YT-25853 | 95 | YT-2613 | 93 | YT-2728 | 84 | YT-2848 | 289 | YT-2977 | 170 | YT-3251 | 164 |
| YT-2407 | 259 | YT-25854 | 95 | YT-2614 | 93 | YT-2729 | 84 | YT-2861 | 139; 242 | YT-2978 | 169 | YT-3252 | 164 |
| YT-2449 | 125 | YT-25855 | 95 | YT-2615 | 93 | YT-2730 | 84 | YT-2862 | 139; 242 | YT-2979 | 169 | YT-3253 | 164 |
| YT-2450 | 125 | YT-25856 | 95 | YT-2618 | 93 | YT-2731 | 84 | YT-2863 | 139; 242 | YT-2980 | 170 | YT-3254 | 164 |
| YT-2451 | 125 | YT-25857 | 95 | YT-2619 | 93 | YT-2732 | 84 | YT-28631 | 139 | YT-2981 | 170 | YT-3255 | 164 |
| YT-2452 | 125 | YT-25861 | 95 | YT-2620 | 84 | YT-2733 | 84 | YT-2864 | 139 | YT-2982 | 170 | YT-3256 | 164 |

PL

I. TOYA S.A. informuje, iż: 1) niniejszy katalog nie stanowi oferty w rozumieniu prawa cywilnego; 2) prezentowane w niniejszym katalogu artykuły mogą w rzeczywistości odbiegać od wskazanego na zdjęciach wzoru, w szczególności jeżeli chodzi o cechy zewnętrzne, tj. wielkość, kolor, sposób opakowania, ilość przedmiotów w opakowaniu; 3) nie ponosi odpowiedzialności za drobne różnice w sposobie pakowania czy właściwościach artykułów pozostających bez wpływu na jego przeznaczony cel lub sposób użytkowania; 4) nie ponosi odpowiedzialności wynikającej z jakichkolwiek niedokładności lub nieścisłości, co do informacji zawartych w przedmiotowym katalogu; 5) nie ponosi odpowiedzialności za ewentualną szkodę powstałą w wyniku otrzymania towaru o innych właściwościach niż prezentowany na zdjęciach.

II. Pomimo najlepszych starań poczynionych przez TOYA S.A. nie może ona zagwarantować, iż informacje zawarte w niniejszym katalogu w pełni odpowiadają rzeczywistości.

III. Wszelkie decyzje podjęte na podstawie informacji zawartych w przedmiotowym katalogu podejmowane są na własne ryzyko osoby, która korzysta z tych informacji.

GB

I. TOYA S.A. informs that: 1) the present catalogue does not constitute an offer as construed in the civil law; 2) the goods presented in the present catalogue may in fact differ from the models shown in the pictures, particularly as far as external properties are concerned, namely size, colour, packaging, number of items in the package; 3) the company will not be held responsible for small differences in packaging or properties of the goods, which do not affect the purpose or the exploitation of the tools; 4) the company will not be held responsible for any inaccuracies or imprecision regarding the information presented in the catalogue; 5) the company will not be held responsible for any damage caused by goods whose properties differ from those of the tools presented in the photographs.

II. In spite of all the efforts made by TOYA S.A., the company cannot guarantee the information contained in the present catalogue fully correspond to the reality.

III. Any decisions made on the basis of the information contained in the present catalogue will be made at the risk of the person who makes them using the aforementioned information.

D

I. TOYA S.A. informiert, dass: 1) der vorliegende Katalog kein Angebot im zivilrechtlichen Sinne darstellt; 2) die im vorliegenden Katalog präsentierten Artikel in der Realität von den auf den Musterfotos gezeigten abweichen können, und zwar besonders dann, wenn es um äußere Eigenschaften geht, wie z.B. Größe, Farbe, Art der Verpackung, Anzahl der Gegenstände in der Verpackung; 3) sie keine Verantwortung für geringfügige Unterschiede bei der Verpackungsart oder den Eigenschaften der Artikel übernimmt, die ohne Auswirkungen auf seinen Bestimmungszweck oder die Art der Nutzung bleiben; 4) sie keine Verantwortung für irgendwelche Oberflächlichkeiten und Ungenauigkeiten bzgl. der im Sachkatalogkatalog enthaltenen Informationen übernimmt; 5) sie keine Verantwortung für eventuelle Schäden, die im Ergebnis des Erhalts der Ware mit anderen als auf den Fotos dargestellten Eigenschaften entstanden sind, übernimmt.

II. Trotz großer Bemühungen seitens TOYA S.A. kann die Firma nicht garantieren, dass die im vorliegenden Katalog enthaltenen Informationen voll der Realität entsprechen.

III. Sämtliche Entscheidungen, die auf der Grundlage der im Sachkatalog enthaltenen Informationen getroffen wurden, gehen auf das Risiko der Person, die diese Informationen benutzt.

RUS

I. TOYA S.A. заявляет: 1) настоящий каталог не является торговым предложением с точки зрения гражданского законодательства; 2) изделия, представленные в настоящем каталоге, могут отличаться от образцов на снимках, особенно внешним видом, то есть размером, цветом, способом упаковки, количеством предметов в упаковке; 3) производитель не отвечает за мелкие отличия в способе упаковки или свойствах изделий, которые не влияют на предназначение или способ пользования изделиями; 4) производитель не отвечает за мелкие неточности в сведениях из предметного каталога; 5) производитель не отвечает за ущерб, нанесенный вследствие поставки товара, отличающегося параметрами от указанного на снимках.

II. Несмотря на все усилия в данном направлении, компания TOYA S.A. не гарантирует, что информация, метящаяся в настоящем каталоге, полностью отвечает действительности.

III. Риск, связанный с любыми решениями, принятыми на основании информации из предметного каталога, берут на себя лица, пользующиеся указанной информацией.

CZ

I. TOYA S.A. informuje že: 1) tento katalog nepředstavuje nabídku ve smyslu občanského práva; 2) výrobky prezentované v tomto katalogu se mohou ve skutečnosti lišit od modelů uvedených na obrázcích, zejména co se týká vnějších znaků, tj. velikosti, barvy, způsobu balení, počtu předmětů v balení; 3) nenese odpovědnost za drobné rozdíly ve způsobu balení nebo ve vlastnostech výrobků, které nemají zásadní vliv na jejich určený účel nebo způsob používání; 4) nenese odpovědnost vyplývající z jakýchkoli nepřesností co do informací uvedených v předmětném katalogu; 5) nenese odpovědnost za případné škody vzniklé v důsledku obdržení zboží s jinými vlastnostmi, než je uvedeno na obrázcích.

II. Navzdory mimořádnému úsilí vynaloženému firmou TOYA S.A. tato nemůže garantovat, zda informace uvedené v tomto katalogu zcela odpovídají skutečnosti.

III. Veškerá rozhodnutí přijatá na základě informací uvedených v předmětném katalogu jsou přijímána na vlastní riziko osoby, která tyto informace využívá.

H

I. A TOYA S.A. tájékoztatja, hogy: 1) a jelen katalógus a polgári jog szerint nem kereskedelmi ajánlat; 2) a jelen katalógusban bemutatott árucikkek a valóságban eltérhetnek a képeken látható mintáktól, különösen a külső tulajdonságok, mint a méret, szín, csomagolási mód, a csomagban lévő tárgyak száma tekintetében; 3) nem vállal felelősséget a csomagolás módjában vagy az árucikkek olyan tulajdonságaiban történt változtatásokért, amelyek nem befolyásolják lényeges módon annak rendelkezését vagy a felhasználás módját; 4) nem vállal felelősséget a jelen katalógusban lévő információk pontatlanságáért; 5) nem vállal felelősséget azokért az esetleges árokért, amik az árucikkek a fényképeken látható tulajdonságoktól eltérő tulajdonságokkal történő leszállításából erednek.

II. A TOYA S.A. minden igyekezete ellenére nem tudja garantálni, hogy a jelen katalógusban található információk teljes egészében megfelelnek a valóságnak.

III. A tárgyi katalógusban található információk alapján meghozott bármilyen döntés annak a személynek a rizikója, aki ezeket az információkat felhasználja.

RO

I. TOYA S.A. informează că: 1) prezentul catalog nu constituie ofertă în înțelesul dreptului civil; 2) articolele prezentate în prezentul catalog se pot diferi față de mostrele din fotografiile, în special aspectul exterior, adică mărimea, culoarea, modul de ambalare, cantitatea obiectelor în ambalaj; 3) nu-și asumă răspunderea referitor la mici diferențe la modul de ambalare sau la articolele al căror proprietăți nu au influență referitor la destinația sau modul lor de utilizare; 4) nu-și asumă răspunderea referitor la orice inexactitate sau imprecizie, datorită informațiilor cuprinse în catalogul respectiv; 5) nu-și asumă răspunderea referitor la o eventuală pagubă ca urmarea primirii marfei cu alte proprietăți decât cele prezentate pe fotografiile; 6) Cu toate strădaniile TOYA S.A., firma nu poate garanta că, informațiile din prezentul catalog corespund realității;

III. Orice decizie preluată în baza informațiilor cuprinse în catalogul respectiv, sunt preluate pe riscul și răspunderea persoanei care a făcut folos de aceste informații.

E

I. TOYA S.A. comunica lo siguiente: 1) el presente catálogo no constituye una oferta, en el sentido que la noción adquiere en la ley civil; 2) los artículos presentados en el presente catálogo pueden en realidad diferir de los modelos indicados en las fotografías, especialmente en cuanto a sus propiedades externas, es decir el tamaño, el color, el empaque o la cantidad de los objetos en el empaque; 3) la empresa no se hace responsable por pequeñas diferencias en cuanto al empaque o las propiedades de los artículos, siempre y cuando estas diferencias no afectan el propósito o el modo de operación de las herramientas; 4) la empresa no se hace responsable por ninguna imprecisión en cuanto a la información presentada en el presente catálogo; 5) la empresa no se hace responsable por ningún daño que surja del hecho de que los artículos recibidos difieran de los artículos presentados en las fotografías en cuanto a sus propiedades.

II. A pesar de los mejores intentos de parte TOYA S.A. la empresa no puede garantizar que la información presentada en el presente catálogo corresponda completamente a la realidad.

III. Todas las decisiones tomadas en base a la información presentada en el presente son responsabilidad de la persona que recurra a la dicha información.

YATO

NOWOŚĆ

KLUCZE PNEUMATYCZNE



KOMPOZYTOWA
OBUDOWA

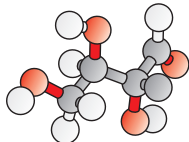

TWIN
HAMMER
TYPE

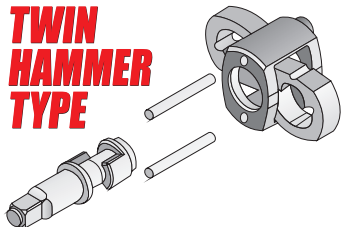

YATO 

YATO 



YATO 



YATO 



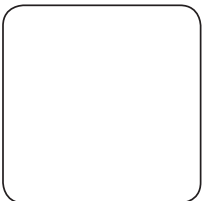



MANUFACTURER / PRODUCENT

ul. Soltysowicka 13-15
51-168 Wrocław
☎ (+48 71) 32 46 200
fax: (+48 71) 32 46 370
sales@yato.pl (sale)
export@yato.pl (export)
import@yato.pl (import)

ODDZIAŁ WARSZAWSKI
Teren ProLogis Park Nadarzyn
al. Kasztanowa 160
05-831 Młochów k. Warszawy
☎ (+48 22) 73 82 800
☎ (+48 22) 73 82 828
sales@yato.pl (sale)
export@yato.pl (export)

YATO TOOLS (SHANGHAI) Co.,Ltd
Building #28, No.1365 lane,
East KangQiao Road,
201315 Shanghai, China
☎ (+86 21) 20981107
fax: +86 21 20981108
yato@yato-sh.com

Sos. Odăi Nr. 109-123,
Sector 1, București,
☎ 0040 031 710 8692,
office@yato.ro

YOUR TRUSTED SUPPLIER: / TWÓJ ZAUFANY DOSTAWCA:



**GET ACQUAINTED WITH OUR WIDE OFFER:
ZOBACZ NASZĄ BOGATĄ OFERTĘ:**



www.yato.com

COPYRIGHT TOYA S.A. 2013

