

**YATO** ®

**2015**



**25**  
YEARS  

**1 SPANNERS / KLUCZE** 4-23

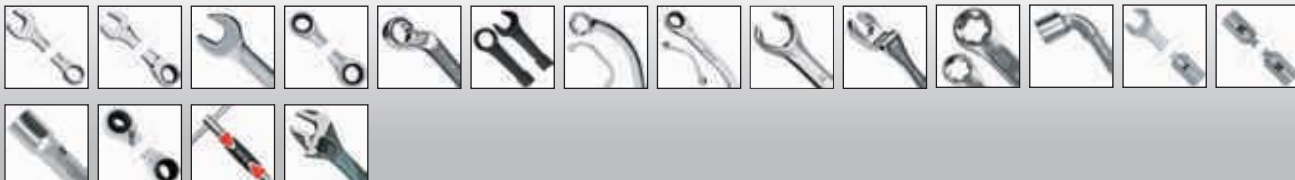

**2 SOCKETS, ACCESSORIES & SETS / KLUCZE NASADOWE, AKCESORIA I ZESTAWY** 24-75



**3 IMPACT SOCKETS, ACCESSORIES & SETS / UDAROWE KLUCZE NASADOWE, AKCESORIA I ZESTAWY** 76-85



**4 TORQUE WRENCHES & TORQUE MULTIPLIERS / KLUCZE DYNAMOMETRYCZNE I WZMACNIACZE MOMENTU** 86-89



**5 SCREWDRIVERS & SCREWDRIIVER BITS / WKREŹTAKI I KOŃCÓWKI WKREŹTAKOWE** 90-117



**6 PLIERS & PIPE WRENCHES / SZCZYPCE I KLUCZE DO RUR** 118-135



**7 ELECTRICIAN TOOLS / NARZĘDZIA DLA ELEKTRYKÓW** 136-153



**8 HAMMERS, CHISELS, PUNCHES & AXES / MŁOTKI, DŁUTA, PRZECINAKI I SIEKIERY** 154-163



**9 CLAMPS, VICES & HOLDERS / ŚCISKI, IMADŁA I WSPORNIKI** 164-169















**10 CUTTING TOOLS / NARZĘDZIA TNĄCE** 170-221

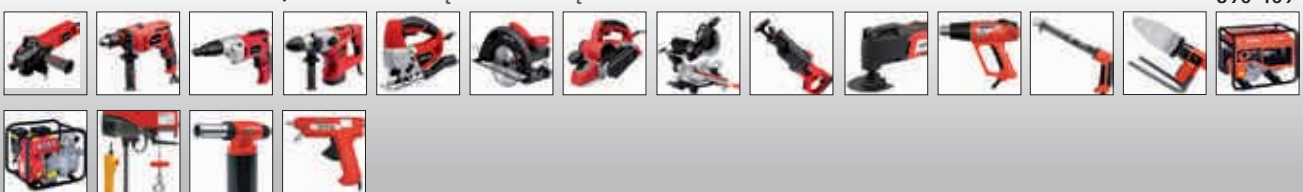

**11 HYDRAULIC TOOLS / NARZĘDZIA HYDRAULICZNE** 222-233



<b>12</b>	<b>FASTENING TOOLS / NARZĘDZIA DO ŁĄCZENIA</b>		234-247
<b>13</b>	<b>CONSTRUCTION TOOLS / NARZĘDZIA BUDOWLANE</b>		248-263
<b>14</b>	<b>MEASURING TOOLS / NARZĘDZIA MIERNICZE</b>		264-273
<b>15</b>	<b>PNEUMATIC TOOLS / NARZĘDZIA PNEUMATYCZNE</b>		274-287
<b>16</b>	<b>SPECIAL AUTOMOTIVE TOOLS &amp; EQUIPMENT / NARZĘDZIA I WYPOSAŻENIE WARSZTATU SAMOCHODOWEGO</b>		288-377
<b>17</b>	<b>WELDING EQUIPMENT &amp; ACCESSORIES / NARZĘDZIA SPAWALNICZE I AKCESORIA</b>		378-389
<b>18</b>	<b>POWER &amp; GASOLINE TOOLS / ELEKTRONARZĘDZIA I NARZĘDZIA SPALINOWE</b>		390-409
<b>19</b>	<b>PADLOCKS &amp; LOCK CYLINDERS / KLÓDKI I WKŁADKI DO ZAMKÓW</b>		410-413
<b>20</b>	<b>ACCESSORIES / AKCESORIA</b>		414-417
<b>21</b>	<b>HEALTH &amp; SAFETY ARTICLES / ARTYKUŁY BHP</b>		418-429
<b>22</b>	<b>ELECTRIC PRODUCTS / ARTYKUŁY ELEKTRYCZNE</b>		430-439
<b>23</b>	<b>GARDEN TOOLS / NARZĘDZIA OGRODNICZE</b>		440-461

# 1

## Spanners Klucze



Combination spanners  
Klucze płasko-oczkowe

6-9

Reversible ratchet half-moon spanners  
Klucze oczkowe typu „C” z grzechotką

18



## Combination spanners &amp; sets, polished head

Klucze płasko-oczkowe i zestawy, polerowana główka

6

## Combination spanners &amp; sets, satin finish

Klucze płasko-oczkowe i zestawy, wykończenie satynowe

7

## Combination spanners S.A.E., polished head

Klucze płasko-oczkowe S.A.E., polerowana główka

8

## Stubby combination spanners, polished head

Klucze płasko-oczkowe krótkie, polerowana główka

9

## Flare nut wrenches &amp; sets

Klucze oczkowe półotwarte i zestawy

18



## Flexible flare nut wrenches &amp; sets

Klucze oczkowe półotwarte z przegubem i zestawy

19



## Combination ratchet wrenches

Klucze płasko-oczkowe z grzechotką

9-11



## Torx ring spanner sets

Zestawy kluczy oczkowych „Torx”

19



## Combination ratchet wrenches &amp; sets

Klucze płasko-oczkowe z grzechotką i zestawy

9

## Non-slip combination ratchet wrenches

Klucze płasko-oczkowe z grzechotką „Non-slip”

10

## Rapid spline ratchet wrenches

Klucze „szybkie” z grzechotką „Spline”

11

## Flexible ratchet combination wrenches

Klucze płasko-oczkowe z grzechotką i przegubem

11

## L-type socket wrenches

Klucze nasadowe typu „L”

19



## Open end swivel head socket wrenches &amp; sets

Klucze płasko-nasadowe, przegubowe i zestawy

20



## Double open end spanners

Klucze płaskie

12-13



## Double flexible socket wrenches

Klucze nasadowe, przegubowe

20



## Double open end spanners &amp; sets, polished head

Klucze płaskie i zestawy, polerowana główka

12

## Double open end spanners &amp; sets, satin finish

Klucze płaskie i zestawy, wykończenie satynowe

13

## Double open end spanners S.A.E., polished head

Klucze płaskie S.A.E., polerowana główka

13

## Tubular socket wrenches &amp; accessories

Klucze rurowe kute i akcesoria

21



## Double ratchet spanners &amp; sets

Klucze oczkowe z grzechotką i zestawy

14



## Double ratchet wrenches

Dwustronne klucze nasadowe z grzechotką

21



## Bi-hexagonal ring spanners

Klucze oczkowe odgięte

14-16



## T-type &amp; Y-type socket wrenches

Klucze nasadowe typu „T” i typu „Y”

21-22



## Bi-hexagonal ring spanners &amp; sets, polished head

Klucze oczkowe odgięte i zestawy, polerowana główka

14

## Bi-hexagonal ring spanners &amp; sets, satin finish

Klucze oczkowe odgięte i zestawy, wykończenie satynowe

15

## Bi-hexagonal ring spanners S.A.E., polished head

Klucze oczkowe odgięte S.A.E., polerowana główka

16

## Socket wrenches with handle

Klucze nasadowe z rękojeścią

21

## T-type deep socket wrenches with rotary handle

Klucze nasadowe typu „T” z obrotową rączką

22

## T-type adapters with rotary handle

Adaptery typu „T” z obrotową rączką

22

## T-type deep socket wrenches

Klucze nasadowe typu „T”

22

## Y-type socket wrenches

Klucze nasadowe typu „Y”

22

## Impact wrenches

Klucze do pobijania

17



## Adjustable wrenches

Klucze nastawne

23



## Ring impact wrenches

Klucze oczkowe do pobijania

17

## Open end impact wrenches

Klucze płaskie do pobijania

17

## Half-moon spanners

Klucze oczkowe typu „C”

18



1

GB Combination spanner  
 D Maulringschlüssel  
 PL Klucz płasko-oczkowy  
 RUS Ключ комбинированный  
 CZ Plochý a očkový klíč  
 H Kulcs villás-csillag  
 RO Cheie combinată

F Clé mixte à cliquet  
 I Chiave combinata  
 E Combinada con llave de estrella  
 CN 两用扳手

DIN 3113 CrV AS-DRIVE

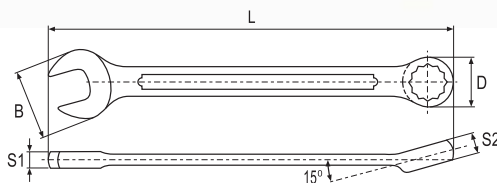

- application: workshop
- head offset: 15°
- surface finish: chromed, satin

- przeznaczenie: warsztat
- kąt odchylenia główki: 15°
- wykończenie powierzchni: chromowana, satynowa

COLOR BOX



YATO	Ø (mm)	L (mm)	B (mm)	D (mm)	S1 (mm)	S2 (mm)	PCS packing	
YT-0335	6	110	14.8	10.5	3.7	4.9	10	300/600
YT-0336	7	120	16.1	11.3	4.0	5.3	10	300/600
YT-0337	8	130	18.5	12.9	4.2	5.0	10	180/360
YT-0338	9	140	20.5	14.6	4.2	5.0	10	180/360
YT-0339	10	150	22.2	16.2	4.9	6.4	10	180/360
YT-0340	11	160	25.5	17.3	4.9	7.0	10	180/360
YT-0341	12	170	26.7	18.7	5.3	7.6	10	120/240
YT-0342	13	180	28.0	19.6	5.5	8.2	10	120/240
YT-0343	14	190	30.3	21.4	5.9	7.7	10	50/100
YT-0344	15	200	32.8	22.8	6.2	8.5	10	50/100
YT-0345	16	210	33.9	23.7	6.1	9.1	10	50/100
YT-0346	17	220	35.9	24.7	6.5	9.1	10	50/100
YT-0347	18	230	37.8	26.9	6.9	10.0	10	50/100

YATO	Ø (mm)	L (mm)	B (mm)	D (mm)	S1 (mm)	S2 (mm)	PCS packing	
YT-0348	19	235	38.9	27.7	7.0	10.1	10	50/100
YT-0349	20	250	41.4	29.2	7.3	11.0	10	40/80
YT-0350	21	260	43.4	31.0	7.1	10.9	10	40/80
YT-0351	22	270	45.9	32.2	8.1	11.2	5	20/40
YT-0352	23	280	47.8	34.3	7.8	11.1	5	20/40
YT-0353	24	290	49.9	34.8	9.2	11.2	5	20/40
YT-0354	25	300	51.2	36.6	9.2	12.4	5	20/40
YT-0355	26	310	53.2	37.4	9.2	12.9	5	20/40
YT-0356	27	320	55.9	39.3	9.3	12.7	5	15/30
YT-0357	28	330	56.5	40.9	9.9	13.5	5	15/30
YT-0358	29	340	60.0	42.4	10.0	13.6	5	15/30
YT-0359	30	350	60.9	43.8	10.0	14.7	5	10/20
YT-0360	32	370	64.5	46.6	11.3	14.9	5	10/20

GB Combination spanner  
 D Maulringschlüssel  
 PL Klucz płasko-oczkowy  
 RUS Ключ комбинированный  
 CZ Plochý a očkový klíč  
 H Kulcs villás-csillag  
 RO Cheie combinată

F Clé mixte à cliquet  
 I Chiave combinata  
 E Combinada con llave de estrella  
 CN 两用扳手

AS-DRIVE

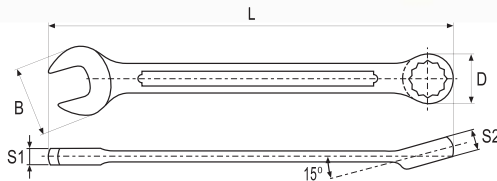

- application: workshop
- head offset: 15°
- surface finish: chromed, satin

- przeznaczenie: warsztat
- kąt odchylenia główki: 15°
- wykończenie powierzchni: chromowana, satynowa

COLOR BOX



YATO	Ø (mm)	L (mm)	B (mm)	D (mm)	S1 (mm)	S2 (mm)	PCS packing	
YT-00760	34	425	65.2	51.0	13.0	16.0	5	20
YT-00761	36	460	73.0	57.0	14.0	17.5	5	15
YT-00762	38	460	73.0	57.0	14.0	17.5	5	15
YT-00763	41	500	83.0	61.5	15.0	19.0	5	10
YT-00764	46	540	88.3	69.0	16.5	21.0	5	10

YATO	Ø (mm)	L (mm)	B (mm)	D (mm)	S1 (mm)	S2 (mm)	PCS packing	
YT-00765	48	570	92.0	72.0	16.5	22.0	5	10
YT-00766	50	598	96.0	74.0	18.0	23.5	2	8
YT-00767	55	620	105.6	82.4	19.0	25.0	2	6
YT-00768	60	660	115.2	89.8	21.0	27.0	2	6
YT-00769	65	680	124.8	97.3	23.0	29.0	2	4

GB Combination spanner set  
 D Maulringschlüsselsatz  
 PL Komplet kluczy płasko-oczkowych  
 RUS Набор ключей комбинированных

CZ Souprava plochých a očkových klíčů  
 H Kulcskészlet, villás-csillag  
 RO Set chei combinate  
 F Set de clés mixtes

I Set chiave combinata  
 E Juego de combinadas con llave de estrella  
 CN 两用扳手组套

POUCH & COLOR BOX



DIN 3113 CrV AS-DRIVE



**12** PCS  
 8, 9, 10, 11, 12, 13, 14, 15, 17, 19, 22, 24 mm

**17** PCS  
 8, 9, 10, 11, 12, 13, 14, 15, 16, 17, 18, 19, 22, 24, 27, 30, 32 mm

**25** PCS  
 6, 7, 8, 9, 10, 11, 12, 13, 14, 15, 16, 17, 18, 19, 20, 21, 22, 23, 24, 25, 26, 27, 28, 30, 32 mm

YATO		
YT-0362	6	

YATO		
YT-0363	3	

YATO		
YT-0365	3	

GB Combination spanner  
D Maulringschlüssel  
PL Klucz płasko-oczkowy  
RUS Ключ комбинированный  
CZ Plochý a očkový klíč  
H Kulcs villás-csillag  
RO Cheie combinată

F Clé mixte à cliquet  
I Chiave combinata  
E Combinada con llave de estrella  
CN 两用扳手

DIN 3113 CrV 6140 AS-DRIVE

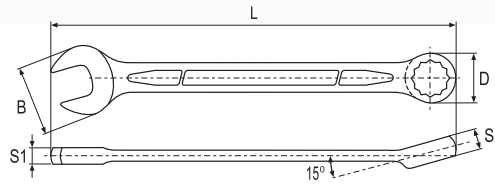

- application: industry
- head offset: 15°
- maximum torque exceeding DIN and ANSI standards by 60%
- surface finish: chromed, satin
- przeznaczenie: przemysł
- kąt odchylenia główki: 15°
- maksymalny moment obrotowy większy o 60% niż w standardach DIN i ANSI
- wykończenie powierzchni: chromowana, satynowa

COLOR BOX



YATO	Ø (mm)	L (mm)	B (mm)	D (mm)	S1 (mm)	S2 (mm)	PCS packing:	
YT-0006	6	109	14.4	10.3	3.7	5.2	10	600
YT-0007	7	119	16.2	11.3	3.8	5.2	10	600
YT-0008	8	129	18.6	12.8	4.2	5.7	10	360
YT-0009	9	139	20.7	14.1	4.3	6.4	10	360
YT-0010	10	149	22.6	15.2	4.8	6.9	10	360
YT-0011	11	159	24.6	16.8	5.2	7.4	10	360
YT-0012	12	169	27.1	18.0	5.3	7.9	10	240
YT-0013	13	179	28.7	19.8	6.0	8.6	10	240
YT-0014	14	189	31.3	20.8	6.2	8.9	10	100
YT-0015	15	199	33.2	22.3	6.6	9.2	10	100
YT-0016	16	209	35.0	23.8	6.8	9.9	10	100
YT-0017	17	219	37.5	25.0	7.0	10.9	10	100
YT-0018	18	229	39.5	26.6	7.8	11.4	10	100
YT-0019	19	239	41.3	28.0	8.0	12.1	10	100
YT-0020	20	249	44.1	29.8	8.3	12.4	10	80
YT-0021	21	259	46.1	30.8	8.6	12.7	10	80

YATO	Ø (mm)	L (mm)	B (mm)	D (mm)	S1 (mm)	S2 (mm)	PCS packing:	
YT-0022	22	269	48.2	32.2	9.0	13.1	5	40
YT-0023	23	279	49.8	33.6	9.2	13.4	5	40
YT-0024	24	289	51.4	34.3	9.6	13.4	5	40
YT-0025	25	299	54.6	36.8	9.8	14.2	5	40
YT-0026	26	309	56.2	37.3	10.0	14.9	5	40
YT-0027	27	319	58.7	39.6	10.4	16.4	5	30
YT-0028	28	329	59.4	40.7	10.8	16.9	5	30
YT-0030	30	349	63.0	43.3	11.3	18.4	5	30
YT-0032	32	369	67.3	44.8	11.8	19.4	4	24
YT-0036	36	435	74.0	53.5	13.8	19.5	-	5/10
YT-0038	38	445	76.0	55.0	16.3	20.3	-	5/10
YT-0041	41	475	83.7	61.6	16.3	20.3	-	2/8
YT-0046	46	545	99.0	75.3	19.5	22.7	-	2/8
YT-0050	50	545	99.5	76.0	19.5	22.7	-	2/8
YT-0055	55	610	110.0	80.0	19.5	22.7	-	2/4

GB Combination spanner set  
D Maulringschlüsselsatz  
PL Komplet kluczy płasko-oczkowych  
RUS Набор ключей комбинированных

CZ Souprava plochých a očkových klíčů  
H Kulcskészlet, villás-csillag  
RO Set chei combinate  
F Set de clés mixtes

I Set chiave combinata  
E Juego de combinadas con llave de estrella  
CN 两用扳手组套

POUCH & COLOR BOX



DIN 3113 CrV 6140

AS-DRIVE



10 PCS  
6, 7, 8, 10, 12, 13, 14, 15, 17, 19 mm

YATO  
YT-0060 20

12 PCS  
8, 9, 10, 11, 12, 13, 14, 15, 17, 19, 22, 24 mm

YATO  
YT-0062 6



15 PCS  
6, 7, 8, 10, 11, 12, 13, 14, 15, 17, 18, 19, 22, 24, 27 mm

YATO  
YT-0065 8

17 PCS  
8, 9, 10, 11, 12, 13, 14, 15, 16, 17, 18, 19, 22, 24, 27, 30, 32 mm

YATO  
YT-0067 3



25 PCS  
6, 7, 8, 9, 10, 11, 12, 13, 14, 15, 16, 17, 18, 19, 20, 21, 22, 23, 24, 25, 26, 27, 28, 30, 32 mm

YATO  
YT-0075 3

GB Combination spanner  
 D Maulringschlüssel  
 PL Klucz płasko-oczkowy  
 RUS Ключ комбинированный  
 CZ Ploché a očkový klič  
 H Kulcs villás-csillag  
 RO Cheie combinată

F Clé mixte à cliquet  
 I Chiave combinata  
 E Combinada con llave de estrella  
 CN 两用扳手

COLOR BOX



DIN  
3113

CrV  
6140

AS-DRIVE

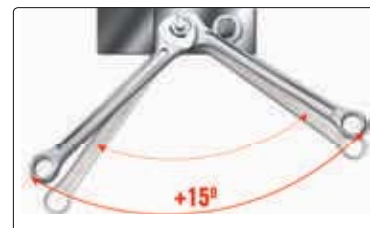
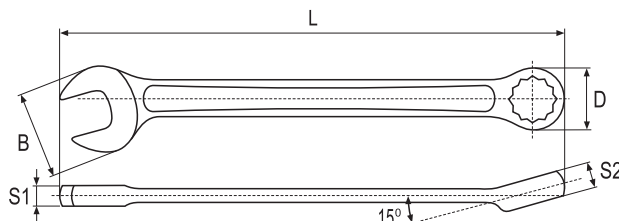

- application: industry
- head offset: 15°
- maximum torque exceeding DIN and ANSI standards by 60%
- surface finish: chromed, satin

- przeznaczenie: przemysł
- kąt odchylenia główki: 15°
- maksymalny moment obrotowy większy o 60% niż w standardach DIN i ANSI
- wykończenie powierzchni: chromowana, satynowa

YATO	Ø (mm)	L (mm)	B (mm)	D (mm)	S1 (mm)	S2 (mm)	PCS packing:	
YT-5000	6	105	14.6	10.6	3.3	6.5	10	600
YT-5001	7	116	16.5	11.6	3.5	6.2	10	600
YT-5002	8	125	18.4	13.0	4.0	6.9	10	360
YT-5003	9	132	20.5	14.5	4.0	7.5	10	360
YT-5005	11	152	24.4	16.8	4.8	8.4	10	360
YT-5006	12	160	26.1	18.3	4.9	8.4	10	240
YT-5008	14	180	30.6	20.9	5.3	9.7	10	100
YT-5009	15	193	33.6	22.6	5.5	10.0	10	100
YT-5010	16	200	34.4	24.5	6.0	10.8	10	100
YT-5012	18	215	38.8	26.5	6.8	11.6	10	100
YT-5014	20	237	43.4	30.1	7.0	12.5	10	80

YATO	Ø (mm)	L (mm)	B (mm)	D (mm)	S1 (mm)	S2 (mm)	PCS packing:	
YT-5015	21	243	45.2	31.1	7.3	13.1	10	80
YT-5016	22	255	46.8	32.4	7.4	13.7	5	40
YT-5017	23	267	49.3	34.3	7.7	13.8	5	40
YT-5018	24	271	50.5	36.1	8.2	14.4	5	40
YT-5019	25	286	53.2	37.1	8.4	14.9	5	40
YT-5020	26	295	54.5	38.7	8.7	15.2	5	40
YT-5021	27	305	56.7	40.0	8.7	16.5	5	30
YT-5022	28	315	58.7	41.6	9.5	16.8	5	30
YT-5023	29	328	60.4	42.5	9.2	17.5	5	30
YT-5024	30	340	62.4	44.7	10.4	18.7	5	30
YT-5025	32	357	66.5	47.2	10.5	20.3	4	24

GB Combination spanner  
 D Maulringschlüssel  
 PL Klucz płasko-oczkowy  
 RUS Ключ комбинированный  
 CZ Ploché a očkový klič  
 H Kulcs villás-csillag  
 RO Cheie combinată

F Clé mixte à cliquet  
 I Chiave combinata  
 E Combinada con llave de estrella  
 CN 两用扳手

S.A.E.

DIN  
3113

CrV

AS-DRIVE

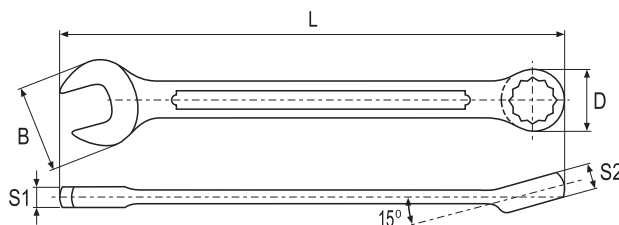

- application: workshop
- head offset: 15°
- surface finish: chromed, satin / mirror

- przeznaczenie: warsztat
- kąt odchylenia główki: 15°
- wykończenie powierzchni: chromowana, satynowa / polerowana

COLOR BOX



YATO	Ø	L (mm)	B (mm)	D (mm)	S1 (mm)	S2 (mm)	PCS packing:	
YT-4870	1/4" (6.3 mm)	110	13.9	10.7	4.0	4.9	10	300/600
YT-4871	5/16" (7.9 mm)	130	17.6	12.8	4.6	5.7	10	180/360
YT-4872	3/8" (9.5 mm)	150	21.5	15.5	4.8	6.1	10	180/360
YT-4873	7/16" (11.1 mm)	160	23.8	17.0	5.1	6.7	10	180/360
YT-4874	1/2" (12.7 mm)	180	27.6	19.9	5.6	8.0	10	120/240
YT-4875	9/16" (14.3 mm)	190	29.6	21.6	6.1	8.1	10	120/240
YT-4876	5/8" (15.9 mm)	210	33.6	23.9	6.3	9.2	10	50/100
YT-4877	11/16" (17.5 mm)	230	37.8	26.3	6.7	10.8	10	50/100

YATO	Ø	L (mm)	B (mm)	D (mm)	S1 (mm)	S2 (mm)	PCS packing:	
YT-4878	3/4" (19.0 mm)	240	40.1	27.9	7.2	10.6	10	50/100
YT-4879	13/16" (20.6 mm)	260	43.2	31.1	7.6	10.8	10	40/80
YT-4880	7/8" (22.2 mm)	270	46.5	32.9	8.4	11.6	5	20/40
YT-4881	15/16" (23.8 mm)	290	50.2	34.9	8.7	12.0	5	20/40
YT-4882	1" (25.4 mm)	300	51.9	36.2	8.8	12.7	5	20/40
YT-4883	1-1/16" (27.0 mm)	320	56.0	38.9	9.3	13.6	5	15/30
YT-4884	1-1/8" (28.6 mm)	340	59.7	42.2	9.8	14.2	5	15/30
YT-4885	1-1/4" (31.8 mm)	370	65.5	46.2	10.9	15.6	5	10/20



GB Stubby combination spanner  
D Maulringschlüssel  
PL Klucz płasko-oczkowy krótki  
RUS Ключ комбинированный  
CZ Ploché a očkový klíč  
H Kulcs villás-csillag  
RO Cheie combinată  
F Clé mixte courte  
I Chiave combinata corta  
E Combinada con llave de estrella  
CN 两用扳手



COLOR BOX



CrV

AS-DRIVE

1

- application: workshop
- head offset: 15°
- surface finish: chromed

- przeznaczenie: warsztat
- kąt odchylenia główki: 15°
- wykończenie powierzchni: chromowana

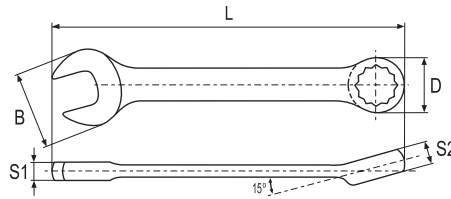

YATO	Ø (mm)	L (mm)	B (mm)	D (mm)	S1 (mm)	S2 (mm)	PCS packing:	
YT-4901	8	91	19.2	13.9	5.0	6.3	10	120/240
YT-4902	9	97	21.7	16.4	5.4	6.4	10	120/240
YT-4903	10	97	21.9	16.6	5.2	6.4	10	120/240
YT-4904	11	100	23.2	18.3	5.9	7.2	10	120/240
YT-4905	12	108	27.4	20.2	6.4	7.6	10	120/240
YT-4906	13	109	27.9	20.7	6.7	7.7	10	120/240

YATO	Ø (mm)	L (mm)	B (mm)	D (mm)	S1 (mm)	S2 (mm)	PCS packing:	
YT-4907	14	115	29.3	22.1	6.1	8.3	10	60/120
YT-4908	15	120	31.2	24.0	6.8	9.6	10	60/120
YT-4909	16	121	32.0	24.3	6.8	9.6	10	60/120
YT-4910	17	128	36.6	27.1	7.4	9.9	10	60/120
YT-4911	18	127	36.2	26.8	7.4	9.9	10	60/120
YT-4912	19	135	39.2	29.5	8.8	10.8	10	60/120

GB Combination ratchet wrench  
D Ratschenringmaulschlüssel  
PL Klucz płasko-oczkowy z grzechotką  
RUS Ключ комбинированный с трещоткой  
CZ Klíč očkoploché ráčnový  
H Csillag-villás kulcs racsnis  
RO Cheie combinată cu crichet  
F Clé mixte à cliquet  
I Chiave combinata a cricchetto reversibile  
E Llave combinada fija abierta y carraca  
CN 棘轮两用扳手



72T

CrV  
6140

AS-DRIVE

- application: service
- 72 teeth ratchet
- minimum operation angle: 5°
- surface finish: chromed, mirror

- przeznaczenie: serwis
- grzechotka 72 zęby
- minimalny kąt pracy: 5°
- wykończenie powierzchni: chromowana, polerowana

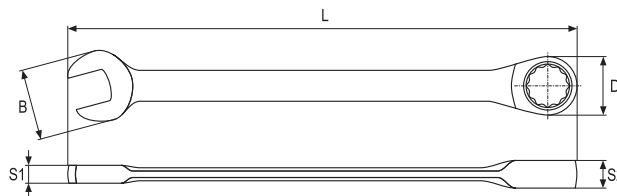

PLASTIC HANGER

PCS packing:

COLOR BOX



YATO	Ø (mm)	L (mm)	B (mm)	D (mm)	S1 (mm)	S2 (mm)	PCS packing:	
YT-01906	6	120	14.7	18.0	4.0	6.5	10	50/100
YT-01907	7	130	16.2	18.0	4.3	7.0	10	50/100
YT-01908	8	141	17.6	18.2	4.8	7.2	10	50/100
YT-01909	9	151	19.4	20.4	4.8	7.4	10	50/100
YT-0191	10	160	22.1	22.2	6.0	7.8	10	50/100
YT-0192	11	165	24.7	24.2	6.6	8.5	10	50/100
YT-0193	12	170	26.4	25.5	6.7	8.9	10	50/100
YT-0194	13	180	27.5	26.7	6.6	9.2	10	50/100
YT-0195	14	190	30.8	29.0	7.4	9.4	10	50/100
YT-0196	15	200	32.9	30.8	7.7	10.1	10	50/100
YT-0197	16	210	34.3	31.5	7.8	10.3	10	50/100

YATO	Ø (mm)	L (mm)	B (mm)	D (mm)	S1 (mm)	S2 (mm)	PCS packing:	
YT-0198	17	225	36.8	33.6	8.4	10.6	10	50/100
YT-0199	18	235	39.2	35.6	9.1	10.8	10	50/100
YT-0200	19	245	40.1	37.3	9.5	11.3	10	50/100
YT-0189	21	290	45.2	43.0	9.9	13.3	6	30/60
YT-0201	22	290	45.6	44.2	10.5	13.4	6	24/48
YT-0202	24	335	52.8	50.0	11.3	14.5	6	48
YT-0203	25	335	52.0	47.4	10.2	14.3	6	30
YT-0204	27	355	55.6	52.7	10.9	15.7	6	30
YT-0205	30	400	62.5	57.7	12.2	17.1	6	24
YT-0206	32	420	65.0	61.7	13.2	17.9	6	24

GB Combination ratchet wrench set  
D Knarrenringmaulschlüssel-satz  
PL Komplet kluczy płasko-oczkowych z grzechotką  
RUS Набор комбинированных ключей с трещоткой  
CZ Klíče ráčnové sada  
H Racsnis csillag-villás kulcs készlet  
RO Set chei combinate  
F Set de clés mixte à cliquet  
I Set chiavi combinate a cricchetto  
E Juego de llaves planas con matraca  
CN 扳手组套

7  
PCSCrV  
6140

72T



AS-DRIVE

10, 12, 13, 14, 15, 17, 19 mm

PLASTIC HANGER

YATO  
YT-0208

10/20

1

- GB Combination ratchet wrench
- D Ratschenringmaulschlüssel
- PL Klucz płasko-oczkowy z grzechotką
- RUS Ключ комбинированный с трещоткой
- CZ Klíč očkoploché ráčnový
- H Csillag-villás kulcs racsnis
- RO Cheie combinata cu crichet
- F Clé mixte à cliquet
- I Chiave combinata a cricchetto reversibile
- E Llave combinada fija abierta y carraca
- CN 棘轮两用扳手

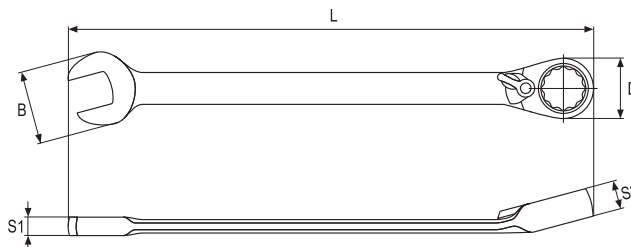

YATO	Ø (mm)	L (mm)	B (mm)	D (mm)	S1 (mm)	S2 (mm)	PCS packing	
YT-1651	8	140	17.5	19.0	6.0	7.2	10	50/100
YT-1652	9	150	19.8	20.7	6.4	7.5	10	50/100
YT-1653	10	160	22.1	23.1	6.4	7.9	10	50/100
YT-1654	11	165	23.9	25.0	6.6	8.4	10	50/100
YT-1655	12	170	27.1	26.0	6.5	8.9	10	50/100
YT-1656	13	180	27.9	27.6	7.1	9.1	10	50/100
YT-1657	14	190	31.6	28.3	7.3	9.5	10	50/100
YT-1658	15	200	32.8	31.4	8.1	9.8	10	50/100
YT-1659	16	210	33.9	32.9	8.4	10.3	10	50/100
YT-1660	17	225	38.0	34.5	8.7	10.5	10	50/100
YT-1661	18	235	39.8	36.9	9.3	10.7	10	50/100
YT-1662	19	245	41.8	38.3	9.5	11.3	10	50/100

YATO	Ø (mm)	L (mm)	B (mm)	D (mm)	S1 (mm)	S2 (mm)	PCS packing	
YT-1663	20	245	41.9	38.1	9.7	11.4	6	30/60
YT-1664	21	290	44.9	43.0	9.8	13.6	6	30/60
YT-1665	22	290	44.8	43.8	10.0	13.6	6	30/60
YT-1666	23	290	44.9	43.3	10.3	13.7	6	24/48
YT-1667	24	330	52.0	49.4	10.2	14.5	6	24/48
YT-1668	25	330	53.0	49.6	10.6	14.7	6	24/48
YT-1669	26	360	56.3	53.6	12.1	15.7	6	30
YT-1670	27	360	55.6	52.9	12.2	16.1	6	30
YT-1671	28	360	56.1	53.6	12.6	16.0	6	24
YT-1672	30	400	62.1	58.0	11.9	17.2	6	24
YT-1673	32	420	64.1	62.0	12.9	17.7	6	24

- GB Combination ratchet wrench
- D Ratschenringmaulschlüssel
- PL Klucz płasko-oczkowy z grzechotką
- RUS Ключ комбинированный с трещоткой
- CZ Klíč očkoploché ráčnový
- H Csillag-villás kulcs racsnis
- RO Cheie combinata cu crichet
- F Clé mixte à cliquet
- I Chiave combinata a cricchetto reversibile
- E Llave combinada fija abierta y carraca
- CN 棘轮两用扳手

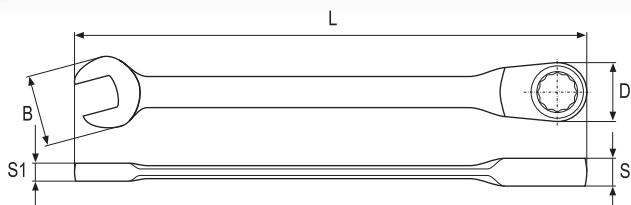

- application: industry
- 72 teeth ratchet
- minimum operation angle: 5°
- NON-SLIP system
- allows to unscrew 70% damaged hex screws
- surface finish: chromed, satin
- przeznaczenie: przemysł
- grzechotka 72 zęby
- minimalny kąt pracy: 5°
- system NON-SLIP
- umożliwia odkręcanie śrub sześciokątnych zniszczonych w 70%
- wykończenie powierzchni: chromowana, satynowa



YATO	Ø (mm)	L (mm)	B (mm)	D (mm)	S1 (mm)	S2 (mm)	
YT-0256	11	163	22.8	22.1	6.0	8.5	10/100

- GB Rapid combination ratchet wrench  
D Ratschenringmaulschlüssel  
PL Klucz „szybki” z grzechotką  
RUS Ключ комбинированный с трещоткой  
CZ Klíč očkoplochy ráčnový  
H Csillag-villás kulcs racsnis  
RO Cheie combinata cu crichet  
F Clé mixte à cliquet  
I Chiave combinata a cricchetto veloce  
E Llave combinada fija abierta y carraca  
CN 棘轮两用扳手

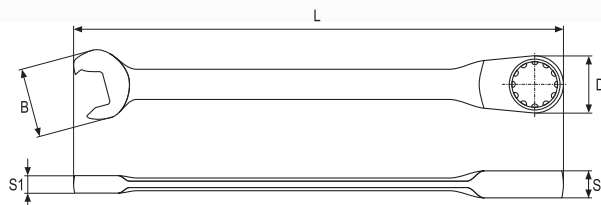
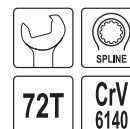
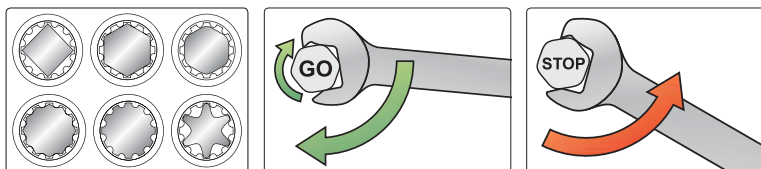

- application: industry
- 72 teeth ratchet
- minimum operation angle: 5°
- spline profile serves for 5 types of nuts
- surface finish: chromed, mirror
- przeznaczenie: przemysł
- grzechotka 72 zęby
- minimalny kąt pracy: 5°
- profil Spline – obsługuje 5 rodzajów nakrętek
- wykończenie powierzchni: chromowana, polerowana

YATO	Ø (mm)	L (mm)	B (mm)	D (mm)	S1 (mm)	S2 (mm)	PCS
YT-0156	9	150	16.65	19.40	4.65	7.28	10/100
YT-0158	11	165	20.32	21.55	5.70	8.20	10/100
YT-0159	12	173	22.47	23.24	6.00	8.20	10/100

YATO	Ø (mm)	L (mm)	B (mm)	D (mm)	S1 (mm)	S2 (mm)	PCS
YT-0162	15	202	27.80	27.55	7.30	8.20	10/100
YT-0163	16	215	30.20	28.55	7.55	9.92	10/100

PLASTIC HANGER

- GB Flexible ratchet combination wrench  
D Ratschenringmaulschlüssel  
PL Klucz płasko-oczkowy z grzechotką i przegubem  
RUS Ключ комбинированный с трещоткой  
CZ Klíč očkoplochy ráčnový  
H Csillag-villás kulcs racsnis  
RO Cheie combinata cu crichet  
F Clé mixte à cliquet tête articulée  
I Chiave combinata a cricchetto testa mobile  
E Llave combinada fija abierta y carraca  
CN 活头棘轮两用扳手

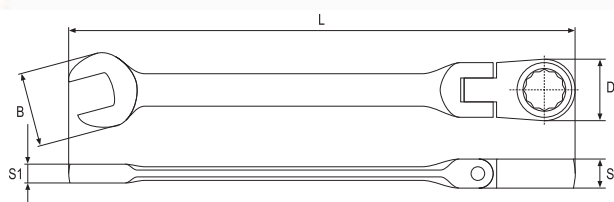
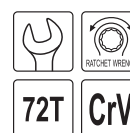

PLASTIC HANGER

COLOR BOX

YATO	Ø (mm)	L (mm)	B (mm)	D (mm)	S1 (mm)	S2 (mm)	PCS packing:
YT-1674	8	140	18.0	19.6	6.3	7.3	10 50/100
YT-1675	9	145	19.7	21.1	4.7	7.6	10 50/100
YT-1676	10	160	22.8	23.2	6.3	7.8	10 50/100
YT-1677	11	160	24.0	24.7	5.4	8.5	10 50/100
YT-1678	12	170	26.4	26.7	6.8	8.8	10 50/100
YT-1679	13	180	28.4	27.3	7.2	9.1	10 50/100
YT-1680	14	185	29.5	28.7	6.8	9.4	10 50/100
YT-1681	15	195	32.9	30.8	7.2	9.8	10 50/100
YT-1682	16	210	34.4	33.3	7.6	10.3	10 50/100
YT-1683	17	230	36.7	35.7	8.3	10.5	10 50/100
YT-1684	18	235	39.0	35.9	8.0	10.8	10 50/100

YATO	Ø (mm)	L (mm)	B (mm)	D (mm)	S1 (mm)	S2 (mm)	PCS packing:
YT-1685	19	245	40.8	37.6	9.5	11.2	10 50/100
YT-1686	20	245	40.9	38.2	8.8	11.1	6 30/60
YT-1687	21	290	45.0	42.8	9.8	13.6	6 30/60
YT-1688	22	290	45.2	42.7	9.8	13.5	6 30/60
YT-1689	23	290	45.3	42.8	9.6	13.6	6 24/48
YT-1690	24	330	51.3	48.7	10.4	14.5	6 24/48
YT-1691	25	330	51.4	48.4	10.6	14.5	6 24/48
YT-1692	26	360	56.6	53.6	11.6	15.7	6 30
YT-1694	28	360	56.4	53.5	11.0	15.8	6 24
YT-1696	32	430	64.7	63.3	12.8	17.8	6 24

- GB Flexible ratchet combination wrench  
D Ratschenringmaulschlüssel  
PL Klucz płasko-oczkowy z grzechotką i przegubem  
RUS Ключ комбинированный с трещоткой  
CZ Klíč očkoplochy ráčnový  
H Csillag-villás kulcs racsnis  
RO Cheie combinata cu crichet  
F Clé mixte à cliquet tête articulée  
I Chiave combinata a cricchetto testa mobile  
E Llave combinada fija abierta y carraca  
CN 活头棘轮两用扳手

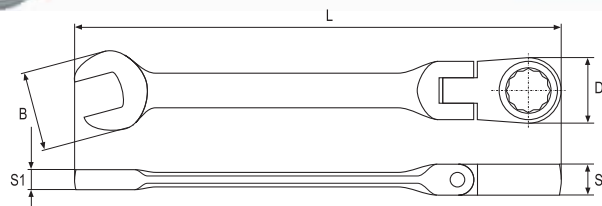
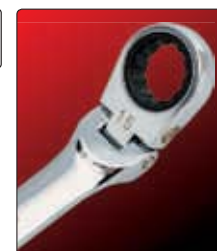

- application: industry
- 72 teeth ratchet
- minimum operation angle: 5°
- articulated joint for ring head
- surface finish: chromed, mirror
- przeznaczenie: przemysł
- grzechotka 72 zęby
- minimalny kąt pracy: 5°
- przegub przy główce oczkowej
- wykończenie powierzchni: chromowana, polerowana

YATO	Ø (mm)	L (mm)	B (mm)	D (mm)	S1 (mm)	S2 (mm)	PCS
YT-0272	11	139	22.8	22.0	6.0	8.4	10/100
YT-0276	15	167	31.6	27.7	7.4	8.4	10/100

YATO	Ø (mm)	L (mm)	B (mm)	D (mm)	S1 (mm)	S2 (mm)	PCS
YT-0279	18	201	39.0	31.7	8.4	11.5	10/100
YT-0280	19	213	39.7	34.2	8.5	11.5	10/100

PLASTIC HANGER

1

- GB Double open end spanner
- D Doppelmaulschlüssel
- PL Klucz płaski
- RUS Ключ рожковый
- CZ Plochéy klíč
- H Villáskulcs
- RO Cheie fixă
- F Clé plate
- I Chiave piatta
- E Llave fija
- CN 双头呆扳手

DIN 3110

CrV



- surface finish:  
chromed, satin / mirror
- wykończenie powierzchni:  
chromowana, satynowa / polerowana



COLOR BOX

YATO	Ø (mm)	L (mm)	B (mm)	D (mm)	S1 (mm)	S2 (mm)	PCS packing	
YT-0367	6x7	120	15.1	16.8	3.5	3.6	10	360/720
YT-0368	8x9	140	18.7	20.8	3.7	3.6	10	180/360
YT-0369	10x11	155	22.4	25.5	4.6	4.6	10	150/300
YT-0332	10x13	170	22.5	29.3	4.6	5.3	10	150/300
YT-0370	12x13	170	27.1	29.3	4.9	5.3	10	80/160
YT-0333	13x17	180	29.3	37.5	5.3	6.3	10	50/100
YT-0371	14x15	180	31.0	33.0	5.3	5.4	10	80/160
YT-0372	16x17	200	34.9	37.5	6.5	6.3	10	50/100

YATO	Ø (mm)	L (mm)	B (mm)	D (mm)	S1 (mm)	S2 (mm)	PCS packing	
YT-0334	17x19	220	37.5	38.7	6.3	6.3	10	50/100
YT-0373	18x19	220	38.7	41.0	6.6	6.3	10	50/100
YT-0374	20x22	230	42.1	46.8	7.1	6.8	10	30/60
YT-0375	21x23	245	44.4	48.6	7.3	6.9	10	30/60
YT-0376	24x27	260	51.6	56.9	8.1	8.1	5	20/40
YT-0377	25x28	270	52.3	57.9	8.4	8.3	5	20/40
YT-0378	30x32	295	61.4	65.1	8.0	8.6	5	15/30

- GB Double open end spanner set
- D Doppelmaulschlüsselsatz
- PL Komplet kluczy płaskich
- RUS Набор рожковых ключей
- CZ Souprava plochéy klíčů
- H Kulcskészlet, villás

- RO Set chei fixe
- F Set de clés à tête fendue
- I Set di chiavi piatte
- E Juego de llaves fijas
- CN 双头呆扳手组套

POUCH & COLOR BOX



DIN 3110

CrV



**10 PCS** 6x7, 8x9, 10x11, 12x13, 14x15, 16x17, 18x19, 20x22, 21x23, 24x27 mm

**12 PCS** 6x7, 8x9, 10x11, 12x13, 14x15, 16x17, 18x19, 20x22, 21x23, 24x27, 25x28, 30x32 mm

YATO	YT-0380	6
------	---------	---

YATO	YT-0381	8
------	---------	---

- GB Double open end spanner
- D Doppelmaulschlüssel
- PL Klucz płaski
- RUS Ключ рожковый
- CZ Plochý klíč
- H Villáskulcs
- RO Cheie fixă
- F Clé plate
- I Chiave piatta
- E Llave fija
- CN 双头呆扳手

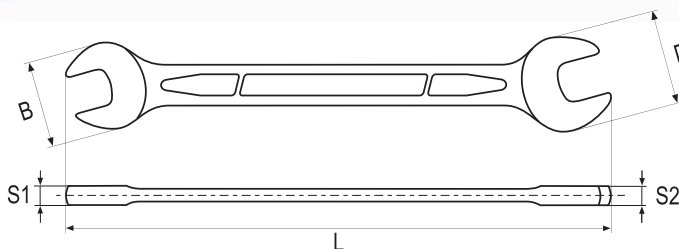

- surface finish:  
chromed, satin
- wykończenie powierzchni:  
chromowana, satynowa

COLOR BOX



YATO	Ø (mm)	L (mm)	B (mm)	D (mm)	S1 (mm)	S2 (mm)	PCS packing	Box
YT-0107	6x7	128	15.5	17.5	3.8	3.8	10	600
YT-0109	8x9	146	19.4	21.4	4.3	4.3	10	360
YT-0110	8x10	146	19.4	21.4	4.3	4.3	10	360
YT-0111	10x11	162	23.5	25.7	5.0	5.0	10	360
YT-0112	10x13	175	27.7	30.2	5.3	5.3	10	120
YT-0113	12x13	175	27.7	30.2	5.3	5.3	10	120
YT-0115	14x15	191	31.7	33.7	5.8	5.8	10	120
YT-0117	13x17	195	31.7	38.7	6.2	6.2	10	120
YT-0118	16x17	212	36.2	38.2	6.3	6.3	10	100

YATO	Ø (mm)	L (mm)	B (mm)	D (mm)	S1 (mm)	S2 (mm)	PCS packing	Box
YT-0119	17x19	224	40.2	42.2	6.8	6.8	10	100
YT-0120	18x19	224	40.2	42.2	6.8	6.8	10	100
YT-0122	19x22	237	44.2	48.2	7.5	7.5	10	60
YT-0123	20x22	237	44.2	48.2	7.5	7.5	10	60
YT-0125	21x23	247	46.2	50.2	7.8	7.8	10	60
YT-0127	24x27	268	53.2	57.7	8.4	8.4	5	40
YT-0128	25x28	268	53.2	57.7	8.4	8.4	5	40
YT-0132	30x32	295	64.2	68.2	9.4	9.4	5	40

- GB Double open end spanner set
- CZ Souprava plochých klíčů
- I Set di chiavi piatte
- D Doppelmaulschlüsselsatz
- H Kulcskészlet, villás
- E Juego de llaves fijas
- PL Komplet kluczy płaskich
- RO Set chei fixe
- CN 双头呆扳手手套
- RUS Набор рожковых ключей
- F Set de clés à tête fendue

POUCH & COLOR BOX



DIN 3110

CrV 6140



**10 PCS** 6x7, 8x9, 10x11, 12x13, 14x15, 16x17, 18x19, 20x22, 21x23, 24x27 mm

**12 PCS** 6x7, 8x9, 10x11, 12x13, 14x15, 16x17, 18x19, 20x22, 21x23, 24x27, 25x28, 30x32 mm

YATO	Box
YT-0150	6

YATO	Box
YT-0152	8

- GB Double open end spanner
- D Doppelmaulschlüssel
- PL Klucz płaski
- RUS Ключ рожковый
- CZ Plochý klíč
- H Villáskulcs
- RO Cheie fixă
- F Clé plate
- I Chiave piatta
- E Llave fija
- CN 双头呆扳手

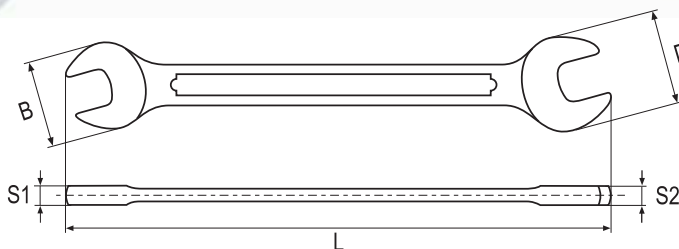

- surface finish:  
chromed, satin / mirror
- wykończenie powierzchni:  
chromowana, satynowa / polerowana

S.A.E. DIN 3110 CrV

COLOR BOX



YATO	Ø	L (mm)	B (mm)	D (mm)	S1 (mm)	S2 (mm)	PCS packing	Box
YT-4830	1/4" (6.3 mm) x 5/16" (7.9 mm)	120	14.8	17.2	3.9	3.9	10	150/300
YT-4831	3/8" (9.5 mm) x 7/16" (11.1 mm)	155	22.0	25.1	4.8	4.8	10	150/300
YT-4832	1/2" (12.7 mm) x 9/16" (14.3 mm)	185	31.2	33.4	5.8	5.8	10	80/160
YT-4833	5/8" (15.9 mm) x 11/16" (17.5 mm)	200	34.6	37.2	6.0	6.1	10	50/100

YATO	Ø	L (mm)	B (mm)	D (mm)	S1 (mm)	S2 (mm)	PCS packing	Box
YT-4834	11/16" (17.5 mm) x 3/4" (19.0 mm)	220	38.7	41.2	7.0	7.0	10	50/100
YT-4835	13/16" (20.6 mm) x 7/8" (22.2 mm)	235	42.7	47.0	7.0	7.0	10	20/40
YT-4836	15/16" (23.8 mm) x 1" (25.4 mm)	260	51.5	56.5	8.3	8.4	5	10
YT-4837	1-1/8" (28.6 mm) x 1-1/4" (31.8 mm)	295	62.6	66.2	8.6	8.7	5	10

1

GB Double ratchet spanner  
 D Ringschlüsselsatz  
 PL Klucz oczkowy z grzechotką  
 RUS Ключ накидной  
 CZ Očkové klíč  
 H Csillagkulcs

RO Cheie inelare  
 F Clé à ceil à cliquet  
 I Chiave a cricchetto  
 E Llave de anillo  
 CN 双头梅花棘轮扳手



CrV  
6140

72T

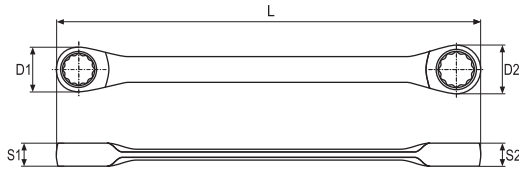

YATO	Ø (mm)	L (mm)	D1 (mm)	D2 (mm)	S1 (mm)	S2 (mm)	PCS packing	Box
YT-5030	8x9	125	18.4	20.2	7.2	7.5	5	100/200
YT-5031	10x11	150	21.9	23.9	8.0	8.5	5	100/200
YT-5033	14x15	190	27.7	29.6	9.5	9.8	5	50/100

GB Double ratchet spanner set  
 D Ringschlüsselsatz  
 PL Klucze oczkowe z grzechotką  
 RUS Набор ключей накидных  
 CZ Očkové klíče  
 H Csillagkulcs készlet

RO Set chei inelare  
 F Set de clés à ceil à cliquet  
 I Set chiavi a cricchetto  
 E Llaves de anillo  
 CN 双头梅花棘轮扳手组套

5  
PCS



CrV  
6140

72T



8x9, 10x11, 12x13, 14x15, 17x19 mm

YATO	Box
YT-5038	10/30

GB Bi-hexagonal ring spanner  
 D Doppelringschlüssel  
 PL Klucz oczkowy odgięty  
 RUS Ключ накидной изогнутый  
 CZ Očkový klíč ohnutý  
 H Hajlítottszerű csillagkulcs  
 RO Cheie inelaro-curbată  
 F Clé contre-coudée  
 I Chiave poligonale doppio piegato  
 E Llave de estrella  
 CN 双头高颈梅花扳手

DIN  
838

CrV

AS-DRIVE

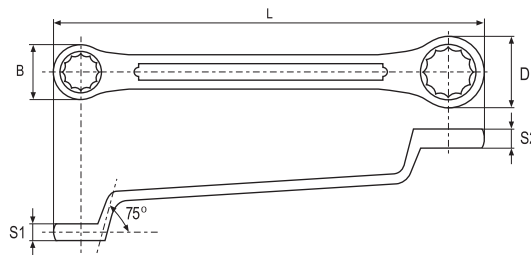

- application: industry
- surface finish: chromed, satin / mirror
- przeznaczenie: przemysł
- wykończenie powierzchni: chromowana, satynowa / polerowana



YATO	Ø (mm)	L (mm)	B (mm)	D (mm)	S1 (mm)	S2 (mm)	PCS packing	Box
YT-0383	6x7	165	11.0	12.7	5.4	5.5	10	200/400
YT-0384	8x9	185	13.9	15.5	6.8	7.2	10	100/200
YT-0385	10x11	200	16.3	17.6	6.8	7.2	10	100/200
YT-0386	12x13	220	19.6	21.5	7.2	7.7	10	60/120
YT-0387	14x15	230	23.6	21.9	8.9	9.1	10	50/100
YT-0388	16x17	255	24.6	26.4	8.6	9.3	10	30/60

YATO	Ø (mm)	L (mm)	B (mm)	D (mm)	S1 (mm)	S2 (mm)	PCS packing	Box
YT-0389	18x19	270	27.5	28.8	10.5	10.2	5	25/50
YT-0390	20x22	290	30.9	33.4	10.5	11.4	5	20/40
YT-0391	21x23	310	31.9	34.4	11.8	12.4	5	20/40
YT-0392	24x27	330	36.2	40.6	11.5	13.2	5	20/40
YT-0394	30x32	390	44.0	47.1	13.8	14.9	3	15/30

GB Bi-hexagonal ring spanner set  
D Doppelringschlüsselsatz  
PL Komplet kluczy oczkowych odgiętych  
RUS Набор ключей накидных изогнутых

CZ Klíče očkové vyhnuté sada  
H Csillagkulcs készlet  
RO Set chei inelare cu cot  
F Set de clés contre-coudées

I Set chiavi poligonali doppie piegate  
E Juego de llaves de estrella acodadas  
CN 双头高颈梅花扳手组套

POUCH  
& COLOR  
BOX



DIN  
838

CrV

AS-DRIVE



8  
PCS

6x7, 8x9, 10x11, 12x13, 14x15,  
16x17, 18x19, 20x22 mm

**YATO**  
YT-0396

6

12  
PCS

6x7, 8x9, 10x11, 12x13, 14x15,  
16x17, 18x19, 20x22, 21x23, 24x27,  
25x28, 30x32 mm

**YATO**  
YT-0398

4

GB Bi-hexagonal ring spanner  
D Doppelringschlüssel  
PL Klucz oczkowy odgięty  
RUS Ключ накидной изогнутый  
CZ Očkový klíč ohnutý  
H Hajlítotszárú csillagkulcs  
RO Cheie inelaro-curbată  
F Clé contre-coudée  
I Chiave poligonale  
doppio piegato  
E Llave de estrella  
CN 双头高颈梅花扳手

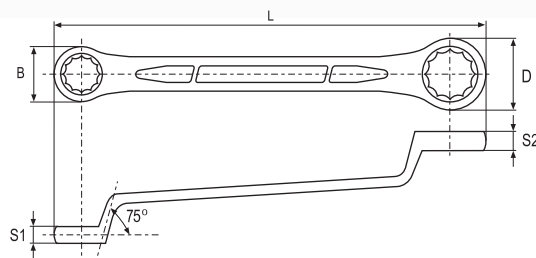

- application: industry
- surface finish: chromed, satin

- przeznaczenie: przemysł
- wykończenie powierzchni: chromowana, satynowa

COLOR BOX



YATO	Ø (mm)	L (mm)	B (mm)	D (mm)	S1 (mm)	S2 (mm)	PCS packing:	
YT-02330	32x36	408	52	46	17.5	17.5	5	20
YT-02331	36x41	448	58	52	18.0	18.0	5	20
YT-02332	41x46	483	65	58	18.5	18.5	5	15

YATO	Ø (mm)	L (mm)	B (mm)	D (mm)	S1 (mm)	S2 (mm)	PCS packing:	
YT-02333	46x50	495	71	65	19.0	19.0	5	10
YT-02334	50x55	538	78	71	19.5	19.5	5	10

GB Bi-hexagonal ring spanner  
D Doppelringschlüssel  
PL Klucz oczkowy odgięty  
RUS Ключ накидной изогнутый  
CZ Očkový klíč ohnutý  
H Hajlítotszárú csillagkulcs  
RO Cheie inelaro-curbată  
F Clé contre-coudée  
I Chiave poligonale  
doppio piegato  
E Llave de estrella  
CN 双头高颈梅花扳手

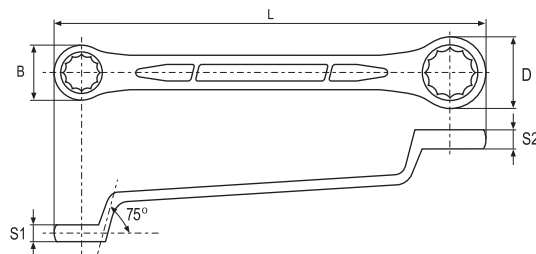

- application: industry
- maximum torque exceeding DIN and ANSI standards by 60%
- surface finish: chromed, satin

- przeznaczenie: przemysł
- maksymalny moment obrotowy większy o 60% niż w standardach DIN i ANSI
- wykończenie powierzchni: chromowana, satynowa

DIN  
838

CrV  
6140

AS-DRIVE

COLOR BOX



YATO	Ø (mm)	L (mm)	B (mm)	D (mm)	S1 (mm)	S2 (mm)	PCS packing:	
YT-0207	6x7	168	10.4	11.9	5.7	6.2	10	320
YT-0209	8x9	183	13.3	14.8	6.7	7.2	10	160
YT-0211	10x11	198	16.3	17.7	7.7	8.8	10	100
YT-0213	12x13	217	19.2	20.6	8.7	9.2	10	100
YT-0215	14x15	239	22.1	23.4	9.6	10.1	5	50
YT-0217	16x17	260	25.0	26.4	10.6	10.9	5	60

YATO	Ø (mm)	L (mm)	B (mm)	D (mm)	S1 (mm)	S2 (mm)	PCS packing:	
YT-0219	18x19	292	27.9	29.4	11.2	11.5	5	60
YT-0222	20x22	318	30.8	33.7	11.8	12.5	5	30
YT-0223	21x23	326	32.3	35.2	12.1	12.8	5	30
YT-0227	24x27	329	36.6	40.7	13.1	14.0	5	30
YT-0228	25x28	347	38.1	42.5	14.0	14.3	2	16
YT-0232	30x32	362	45.2	49.2	15.0	15.7	2	16

1

GB Bi-hexagonal ring spanner set  
 D Doppelringschlüsselsatz  
 PL Komplet kluczy oczkowych odgiętych  
 RUS Набор ключей накидных изогнутых

CZ Klíče očkové vyhnuté sada  
 H Csillagkulcs készlet  
 RO Set chei inelare cu cot  
 F Set de clés contre-coudées

I Set chiavi poligonali doppie piegate  
 E Juego de llaves de estrella acodadas  
 CN 双头高颈梅花扳手组套

POUCH  
& COLOR  
BOX



DIN  
838

CrV  
6140

AS-DRIVE



**8**  
PCS 6x7, 8x9, 10x11, 12x13, 14x15, 16x17,  
18x19, 20x22 mm

**10**  
PCS 6x7, 8x9, 10x11, 12x13, 14x15, 16x17,  
18x19, 20x22, 21x23, 24x27 mm

**12**  
PCS 6x7, 8x9, 10x11, 12x13, 14x15, 16x17, 18x19,  
20x22, 21x23, 24x27, 25x28, 30x32 mm

<b>YATO</b>	
YT-0248	6

<b>YATO</b>	
YT-0250	10

<b>YATO</b>	
YT-0252	4

GB Bi-hexagonal ring spanner  
 D Doppelringschlüssel  
 PL Klucz oczkowy odgięty  
 RUS Ключ накидной изогнутый  
 CZ Očkový klíč ohnutý  
 H Hajlítottszárú csillagkulcs  
 RO Cheie inelaro-curbată  
 F Clé contre-coudée  
 I Chiave poligonale  
 doppio piegato  
 E Llave de estrella  
 CN 双头高颈梅花扳手

S.A.E.

DIN  
838

CrV

AS-DRIVE

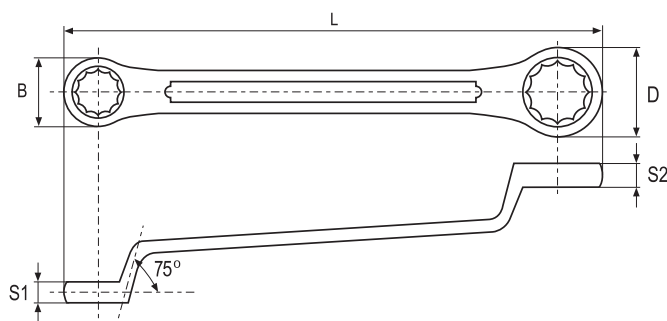

- application: industry
- surface finish: chromed, satin / mirror
- przeznaczenie: przemysł
- wykończenie powierzchni: chromowana, satynowa / polerowana

COLOR BOX



<b>YATO</b>		L (mm)	B (mm)	D (mm)	S1 (mm)	S2 (mm)	PCS packing	
YT-4860	3/8" (9.5 mm) x 7/16" (11.1 mm)	200	16.2	17.5	6.8	6.4	10	150/300
YT-4861	1/2" (12.7 mm) x 9/16" (14.3 mm)	235	21.8	23.3	8.4	8.3	10	80/160
YT-4862	11/16" (17.5 mm) x 3/4" (19.0 mm)	265	27.0	28.3	10.1	10.0	10	50/100

<b>YATO</b>		L (mm)	B (mm)	D (mm)	S1 (mm)	S2 (mm)	PCS packing	
YT-4863	13/16" (20.6 mm) x 7/8" (22.2 mm)	280	30.5	33.3	11.1	11.9	10	20/40
YT-4864	7/8" (22.2 mm) x 15/16" (23.8 mm)	305	33.2	35.9	11.8	13.3	5	10
YT-4865	15/16" (23.8 mm) x 1" (25.4 mm)	325	35.8	40.0	13.6	13.7	5	10



GB Ring impact wrench  
D Schlagringschlüssel  
PL Klucz do pobijania oczkowy  
RUS Ключ закрытый для растряски  
CZ Klíč maticový očkový rázový  
H Űtőcsillagkulcs  
RO Cheie inelară cu bătător  
F Clé à frapper à œil  
I Chiave poligonale semplice a percussione  
E Llave de muletilla para usarse dando golpes  
CN 敲击梅花扳手

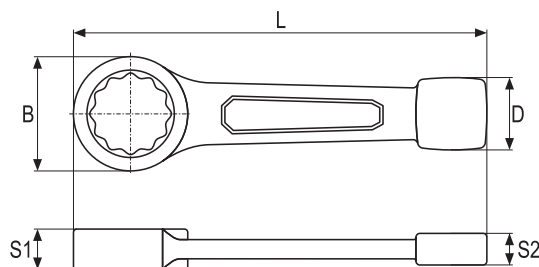

- application: industry
- 12 point profile
- AS-Drive system
- drop forged
- surface finish: black oxidised
- przeznaczenie: przemysł
- profil 12-kątny
- system AS-Drive
- kute
- wykończenie powierzchni: czarna, oksydowana

YATO	Ø (mm)	L (mm)	B (mm)	D (mm)	S1 (mm)	S2 (mm)	
YT-1601	24	160	41	31	15.0	10	5/25
YT-1602	27	185	47	33	15.0	12	5/25
YT-1603	30	190	51	35	16.5	14	5/25
YT-1604	32	195	54	37	16.5	15	5/25
YT-1605	36	210	60	39	20.0	17	5/10
YT-1606	38	210	60	39	20.0	17	5/10
YT-1607	41	225	66	42	20.0	18	5/10

YATO	Ø (mm)	L (mm)	B (mm)	D (mm)	S1 (mm)	S2 (mm)	
YT-1608	46	240	74	44	22.0	19	5/10
YT-1609	50	250	80	45	23.0	20	5/10
YT-1610	55	270	86	55	25.0	22	5/10
YT-1611	58	270	86	55	25.0	22	5
YT-1612	60	270	92	60	25.0	23	5
YT-1613	65	290	100	65	30.0	24	5
YT-1614	70	310	108	70	32.0	25	5

GB Open end impact wrench  
D Schlagschraubenschlüssel  
PL Klucz do pobijania płaski  
RUS Ключ плоский для растряски  
CZ Klíč maticový plochý rázový  
H Űtőlaposkulcs  
RO Cheie fixă cu bătător  
F Clé à frapper plate  
I Chiave a forchetta semplice a percussione  
E Llave de boca abierta para usarse dando golpes  
CN 敲击开口扳手

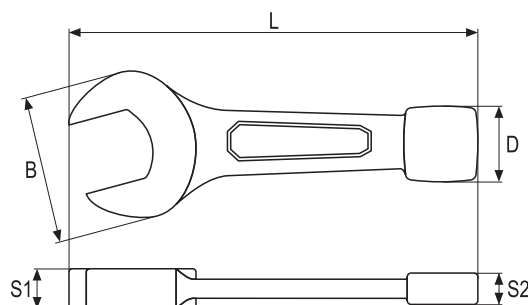

- application: industry
- head offset: 15°
- drop forged
- surface finish: black oxidised
- przeznaczenie: przemysł
- kąt odchylenia główki: 15°
- kute
- wykończenie powierzchni: czarna, oksydowana

YATO	Ø (mm)	L (mm)	B (mm)	D (mm)	S1 (mm)	S2 (mm)	
YT-1615	27	180	55	33	15	12	5/25
YT-1616	30	187	63	35	17	14	5/25
YT-1617	32	195	67	37	18	15	5/25
YT-1618	36	210	77	39	18	17	5/10

YATO	Ø (mm)	L (mm)	B (mm)	D (mm)	S1 (mm)	S2 (mm)	
YT-1619	41	225	89	42	20	18	5/10
YT-1620	46	255	98	44	20	19	5/10
YT-1621	50	280	107	45	22	20	5
YT-1622	55	310	118	55	25	22	5

1

GB Half-moon spanner  
D Starter- und Blockschlüssel  
PL Klucz oczkowy typu „C”  
RUS Ключ накладной изогнутый „C”  
CZ Klíč očkoploché typ „C”  
H Félhold alakú csillagkulcs  
RO Cheie inelara semi-luna  
F Clé à œil „C”

I Chiave poligonale doppio speciale tipo „C”  
E Llave de estrella tipo „C”  
CN C型梅花扳手

CrV 6140 AS-DRIVE

- application: industry
- excellent for work in tight spaces
- used for dismantling of collector tubes, alternators and starters
- surface finish: chromed, satin

- przeznaczenie: przemysł
- do pracy w miejscach szczególnie trudnodostępnych
- ułatwia odkręcanie kolektorów, alternatorów i rozruszników samochodowych
- wykończenie powierzchni: chromowana, satynowa

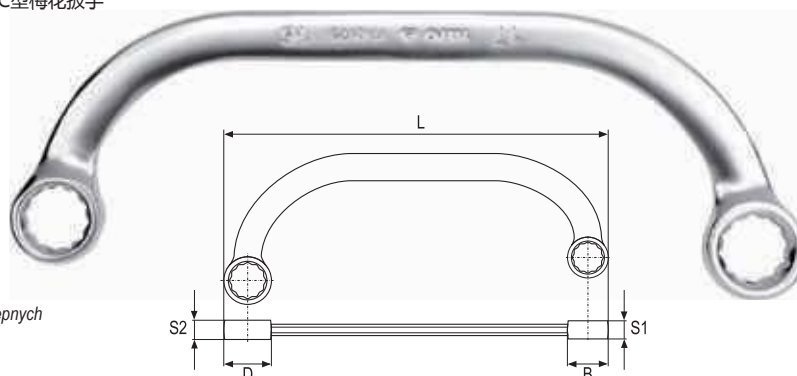

YATO	Ø (mm)	L (mm)	B (mm)	D (mm)	S1 (mm)	S2 (mm)	Box
YT-0170	10x12	145	16.8	19.2	6.8	6.8	10/60
YT-0171	11x13	170	18.5	21.2	8.4	8.6	10/60
YT-0172	14x15	195	22.8	25.8	9.2	9.9	10/60

YATO	Ø (mm)	L (mm)	B (mm)	D (mm)	S1 (mm)	S2 (mm)	Box
YT-0173	16x17	220	26.2	28.6	9.9	10.5	10/60
YT-0175	19x22	260	28.7	32.9	10.4	10.9	6/60

GB Reversible half-moon spanner  
D Doppelingratschenschlüssel  
PL Klucz typu „C” z grzechotką  
RUS Ключ накладной изогнутый с трехоткой  
CZ Klíč očkový ráčnový typu „C”  
H Csillagkulcs racsnis hajlított  
RO Cheie reversibila semi-luna

F Clé mixte à cliquet  
I Chiave tipo „C” con cricchetto  
E Llave de carraca de dos bocas con angulo  
CN C型双向棘轮梅花扳手

72T CrV 6140 AS-DRIVE

- application: industry
- minimum operation angle: 5°
- direction switch
- excellent for work in tight spaces
- used for dismantling of collector tubes, alternators and starters
- surface finish: chromed, mirror

- przeznaczenie: przemysł
- minimalny kąt pracy: 5°
- zmiana kierunku obrotu
- do pracy w miejscach szczególnie trudnodostępnych
- ułatwia odkręcanie kolektorów, alternatorów i rozruszników samochodowych
- wykończenie powierzchni: chromowana, polerowana

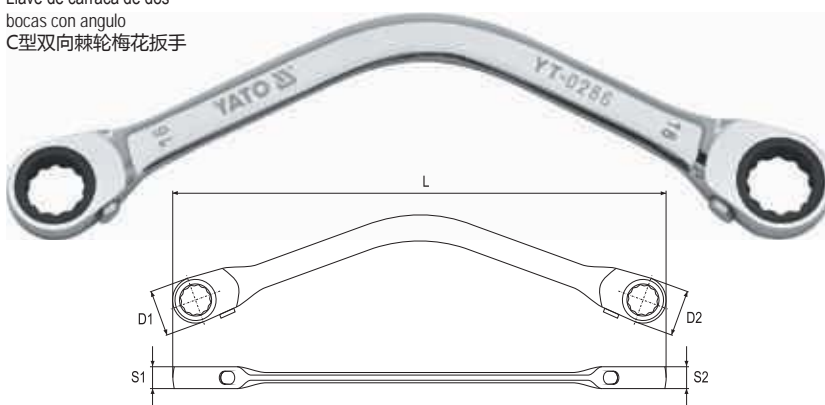

YATO	Ø (mm)	L (mm)	D1 (mm)	D2 (mm)	S1 (mm)	S2 (mm)	Box
YT-0284	12x15	206	23.6	28.2	8.4	8.4	10/100
YT-0286	16x18	247	28.6	31.7	10.0	11.5	10/100
YT-0287	17x19	260	29.7	33.8	10.0	11.5	10/100

PLASTIC HANGER



GB Flare nut wrench  
D Schraubenschlüssel, halboffen  
PL Klucz oczkowy półotwarty  
RUS Ключ накладной полуоткрытый  
CZ Klíč prstencový polootevřený  
H Csuklós, nyitott

RO Cheie inelară semideschisă  
F Clé mixte à cliquet  
I Chiave poligonale semiaperto  
E Llave semiabierta  
CN 油管扳手

CrV 6140

GB Flare nut wrench set  
D Schraubenschlüssel, halboffen  
PL Zestaw kluczy oczkowych półotwartych  
RUS Ключ накладной полуоткрытый  
CZ Klíč prstencový polootevřený  
H Csuklós, nyitott

RO Cheie inelară semideschisă  
F Set de clés à tête fendue  
I Set chiavi poligonali semiaperte  
E Llave semiabierta  
CN 油管扳手组套

4 PCS



CrV 6140

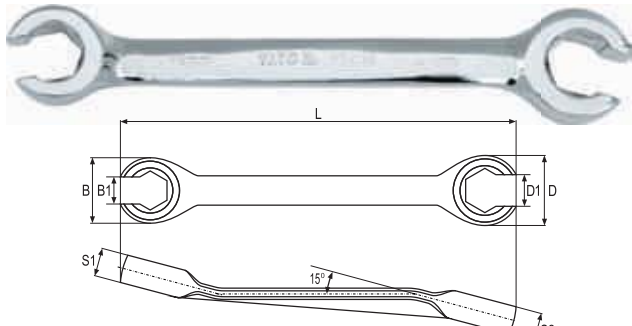

COLOR BOX

YATO	Ø (mm)	L (mm)	B (mm)	D (mm)	B1 (mm)	D1 (mm)	S1 (mm)	S2 (mm)	PCS packing	Box
YT-0135	8x10	140	18.7	21.8	6.2	7.2	7.7	8.4	10	200/400
YT-0136	11x12	160	21.2	24.0	8.1	9.2	8.5	9.5	10	100/200
YT-0137	13x14	175	26.3	27.3	9.6	10.7	9.6	10.5	10	100/200
YT-0138	15x17	190	31.2	31.2	11.8	13.0	11.5	10.9	10	50/100
YT-01385	17x19	195	29.0	31.2	14.5	15.0	12.4	12.8	10	50/100
YT-0139	19x21	230	36.3	42.1	14.7	16.7	12.4	12.8	10	50/100
YT-0140	22x24	250	42.7	44.2	17.1	18.6	13.2	13.9	10	50/100



8x10, 11x12, 13x14, 15x17 mm

POUCH & COLOR BOX



YATO	Box
YT-0143	25/50

GB Flexible flare nut wrench  
D Schraubenschlüssel, halboffen mit Gelenk  
PL Klucz oczkowy półotwarty z przegubem  
RUS Ключ накладной полуоткрытый с шарниром  
CZ Klíč prstencový polootevřený s kloubem  
H Csuklós, nyitott csillagkulcs  
RO Cheie inelară semideschisă, cu articulație  
F Clé à tête fendue articulée  
I Chiave poligonale a due bocche aperte con testa snodata  
E Llave semiabierta con una junta  
CN 活头油管扳手

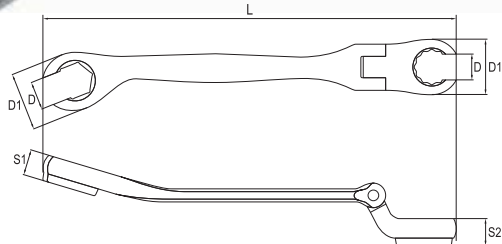

- application: industry
- articulated joint at 12 point head
- ring for nuts in sockets
- for use on hydraulic lines
- for use on fuel lines
- for use on brake system lines
- ergonomic handle
- surface finish: chromed, satin
- przeznaczenie: przemysł
- przegub przy profilu 12-kątym
- pierścień do gniazd nakrętek
- do przewodów hydraulicznych
- do przewodów paliwowych
- do przewodów hamulcowych
- ergonomiczna rączka
- wykończenie powierzchni: chromowana, satynowa

PLASTIC HANGER

YATO	Ø (mm)	L (mm)	D (mm)	D1 (mm)	S1 (mm)	S2 (mm)	Box
YT-0180	8	128	6.0	18.0	7.0	7.0	24/288
YT-0181	9	128	6.5	18.0	7.0	7.0	24/288
YT-0184	12	148	9.0	22.0	9.0	9.0	24/216
YT-0185	13	175	10.0	26.0	11.0	11.0	12/120
YT-0186	14	175	11.0	26.0	11.0	11.0	12/120
YT-0187	15	175	12.0	26.0	11.0	11.0	12/120

GB Flexible flare nut wrench set  
D Schraubenschlüssel, halboffen mit Gelenk  
PL Komplet kluczy oczkowych półotwartych z przegubem  
RUS Ключ накладной полуоткрытый с шарниром  
CZ Klíč prstencový polootevřený s kloubem  
H Csuklós, nyitott csillagkulcs  
RO Cheie inelară semideschisă, cu articulație  
F Set de clés à tête fendue articulée  
I Set chiavi poligonali a due bocche aperte con testa snodata  
E Llave semiabierta con una junta  
CN 活头油管扳手套组

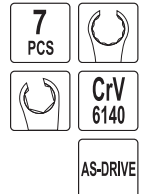

8, 10, 11, 12, 13, 14, 17 mm

PLASTIC HANGER

YATO	Box
YT-0190	5/20

GB Torx ring spanner set  
D Torx-Ringschlüsselsatz  
PL Komplet kluczy oczkowych Torx  
RUS Набор накидных ключей  
CZ Očkové klíče  
H Csillagkulcs készlet  
RO Cheie inelare  
F Set de clés à œil  
I Set chiavi doppie Torx  
E Llaves de anillo Torx  
CN 星型扳手套组



E6xE8, E10xE12, E14xE18, E20xE24

SLIDING CARD

YATO	Box
YT-0530	10/60

GB L-type socket wrench  
D Steckschlüssel gebogen  
PL Klucz nasadowy typu „L”  
RUS Ключ торцевой „L” типа  
CZ Nástrčný klíč fajfkový  
H Kulcs, dugó-pipa  
RO Cheie tubulara cu cot tip „L”  
F Clé à pipe en L  
I Chiave a tubo doppio tipo „L”  
E Llave de vaso „L”  
CN L 型套筒扳手

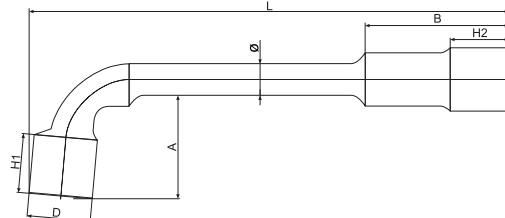

YATO	Ø (mm)	L (mm)	B (mm)	H1 (mm)	H2 (mm)	A (mm)	D (mm)	Ø (mm)	Box
YT-1627	7	106	27.0	10.2	10.1	21.0	10.7	7	12/60
YT-1628	8	117	29.5	12.3	11.9	18.5	12.2	9	12/60
YT-1629	9	121	31.7	13.4	12.8	19.1	13.2	10	12/60
YT-1630	10	131	35.1	16.4	16.9	23.3	15.0	10	12/60
YT-1631	11	138	36.0	16.5	16.8	24.7	16.3	11	12/60
YT-1632	12	147	42.5	17.9	18.2	17.9	18.0	12	12/60
YT-1633	13	154	44.2	18.5	19.1	30.1	19.3	12	12/60
YT-1634	14	162	47.0	19.3	20.3	30.2	20.8	13	12/60
YT-1635	15	173	48.9	20.6	21.6	31.6	22.3	13	12/60
YT-1636	16	182	55.0	23.2	23.1	37.3	23.6	14	12/60
YT-1637	17	188	57.0	25.1	25.5	37.9	25.1	14	12/36

YATO	Ø (mm)	L (mm)	B (mm)	H1 (mm)	H2 (mm)	A (mm)	D (mm)	Ø (mm)	Box
YT-1638	18	192	57.1	25.1	24.6	40.1	26.0	14	12/36
YT-1639	19	207	62.3	26.9	27.4	41.6	28.2	16	12/36
YT-1640	20	215	62.4	27.0	28.3	42.4	29.2	16	6/24
YT-1641	21	221	65.0	30.5	30.6	54.0	30.2	16	6/24
YT-1642	22	232	67.5	30.8	30.6	49.1	31.7	16	6/24
YT-1643	23	242	77.1	31.4	31.2	51.6	33.0	17	6/18
YT-1644	24	253	78.2	32.3	31.7	53.5	33.6	17	6/18
YT-1647	27	288	85.3	36.9	36.4	54.7	37.6	20	6/12
YT-1649	30	310	95.0	38.4	38.6	65.3	42.0	22	6/12
YT-1650	32	339	99.2	40.4	40.5	66.8	43.8	22	6

1

- GB Open end swivel head socket wrench
- D Maul-Steckschlüssel
- PL Klucz płasko-nasadowy przegubowy
- RUS Ключ рожково-торцевой
- CZ Klic nasad. ploch.
- H Kulcs villás-dugó
- RO Cheie fixe-tubulare
- F Clé mixte tête articulée (plat/à tube)
- I Chiave combinata a bussola con snodo
- E Combinada con vaso
- CN 套筒开口扳手

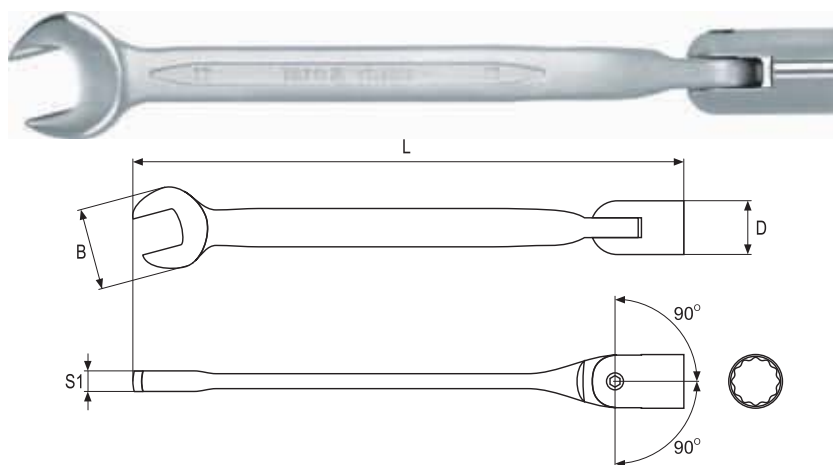

CrV  
6140



YATO	Ø (mm)	L (mm)	B (mm)	D (mm)	S1 (mm)	PCS packing	
YT-4950	8	168	19.5	12.9	6.0	10	240
YT-4951	10	178	20.7	14.6	6.4	10	240
YT-4952	11	188	25.4	15.9	6.9	10	200
YT-4953	12	191	25.3	17.9	6.7	10	160

YATO	Ø (mm)	L (mm)	B (mm)	D (mm)	S1 (mm)	PCS packing	
YT-4954	13	205	28.8	18.8	6.8	10	120
YT-4955	14	222	31.8	19.8	6.8	10	80
YT-4956	17	232	37.0	23.9	7.8	10	80
YT-4957	19	248	42.1	25.8	7.5	10	60

- GB Open end swivel head socket wrench set
- H Kulcs villás-csuklós dugó
- D Maul-Steckschlüsselsatz
- RO Set chei fixe + tubulare
- PL Klucze płasko-nasadowe przegubowe
- F Set de clés mixtes tête articulée (plat/à tube)
- RUS Ключи рожк.-торц.-назор
- I Set chiavi a tubo
- CZ Ploché nřstrčné klıče kloubové
- E Combinadas con vaso articulado
- CN 套筒开口扳手组套

6  
PCS CrV  
6140



POUCH & COLOR BOX



8, 10, 12, 13, 17, 19 mm

YATO	PCS
YT-4960	20

- GB Double flexible socket wrench
- D Steckschlüssel
- PL Klucz nasadowy przegubowy
- RUS Ключ торцевой
- CZ Nástrčné klıče kloubové
- H Cuklós dugókulcs
- RO Set chei tubulare cu articulație
- F Clé à tube tête articulée
- I Chiave a doppia bussola snodata
- E Llave de vaso articulado
- CN 活头双头套筒扳手

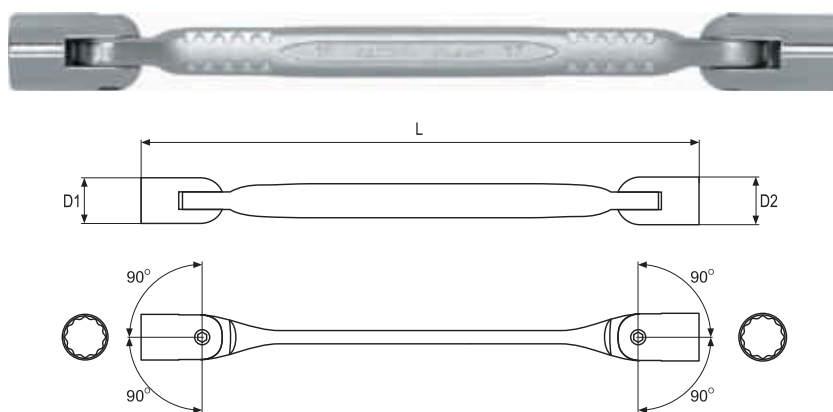

CrV  
6140



YATO	Ø (mm)	L (mm)	D1 (mm)	D2 (mm)	PCS packing	
YT-4961	8x9	183	12.9	13.7	10	200
YT-4962	10x11	202	14.6	15.8	10	160
YT-4963	12x13	218	17.6	18.8	10	120

YATO	Ø (mm)	L (mm)	D1 (mm)	D2 (mm)	PCS packing	
YT-4964	14x15	239	19.8	21.7	10	80
YT-4965	16x17	257	23.8	23.9	10	40
YT-4966	18x19	274	25.8	25.8	10	40

- GB Heavy duty tubular socket wrench
- D Rohrsteckschlüsselsatz
- PL Klucz rurowy kuty
- RUS Ключ двухлучевой с головками
- CZ Klíče trubkové
- H Csőkulcs
- RO Cheie pt. țevi
- F Clé à tube double droite
- I Chiave a tubo
- E Llave de tubería
- CN 小轮胎扳手

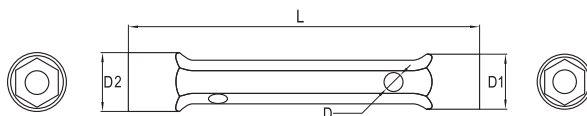

CrV 40 AS-DRIVE

COLOR BOX



YATO	Ø (mm)	D1 (mm)	D2 (mm)	D (mm)	L (mm)	PCS packing:	
YT-4915	8x9	13	14	3	110	10	60/240
YT-4916	10x11	15	16	5	120	10	60/240
YT-4917	12x13	18	19	6	140	10	60/120
YT-4918	14x15	20	22	6	145	10	60/120
YT-4919	16x17	23	24	7	155	10	60/120
YT-4920	18x19	25	26	8	165	5	40/80

YATO	Ø (mm)	D1 (mm)	D2 (mm)	D (mm)	L (mm)	PCS packing:	
YT-4921	20x22	28	30	8	170	5	30/60
YT-4922	21x23	29	31	10	185	5	30/60
YT-4923	24x26	33	35	12	190	5	40
YT-4924	25x28	34	37	12	205	5	40
YT-4925	27x29	37	39	12	210	5	40
YT-4926	30x32	40	42	13	210	5	20

- GB Tubular socket wrench handle
- CZ Tyčka k trubkovým klíčům
- I Spina di manovra per chiave a tubo doppia
- D Stellstab für Rohrschlüssel
- H Forgatókar dugókulcsához
- E Mango para las llaves de tubo
- PL Pokręto do kluczy rurowych
- RO Clupă pt. chei tubulare
- CN 旋棒
- RUS Вороток к трубчатым ключам
- F Support de clés à tube

CrV 40

COLOR BOX



YATO	L (mm)	mm	PCS packing:	
YT-4927	190	2.5; 4.5; 5.5	50	150
YT-4928	280	6.5; 7.5; 9.5; 11.5; 12.5	50	100

- GB Ratchet wrench
- D Gerüstratsche
- PL Klucz nasadkowy z grzechotką
- RUS Ключ торцовый с трещоткой
- CZ Ráčnový klíč průchozí
- H Kettős racsnis kulcs
- RO Cheie tubulara cu clichet
- F Clé à tube à cliquet
- I Chiavi a cricchetto per ponteggi
- E Llave de vaso con carraca
- CN 尖尾棘轮扳手



CrV 32T RATCHET WRENCH COLD FORGED KUTE NA ZIMNO



PLASTIC HANGER

YATO	Ø (mm)	L (mm)	
YT-4937	19x22	315	2/40

- GB Double ratchet wrench
- D Gerüstratsche
- PL Dwustronny klucz nasadkowy z grzechotką
- RUS Ключ торцовый с трещоткой
- CZ Ráčnový klíč průchozí dvoustranný
- H Kettős racsnis kulcs
- RO Cheie tubulara dubla cu clichet
- F Clé à œil à cliquet
- I Chiave a cricco doppio
- E Llave de vaso con carraca
- CN 尖尾棘轮扳手

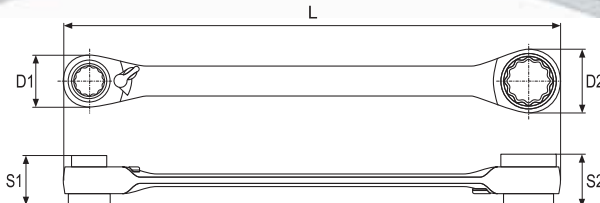

CrV 72T RATCHET WRENCH



DOUBLE BLISTER

YATO	Ø (mm)	L (mm)	D1 (mm)	D2 (mm)	S1 (mm)	S2 (mm)	
YT-4945	10x13x17x19	200	29	35	17	22	5/50

- GB Socket wrench with handle
- RUS Ключ торцевой
- F Clé à tube
- D Steckschlüssel
- CZ Nástrčný klíč
- I Chiave a cricco doppio
- PL Klucz nasadowy z rączką
- H Kulcs
- E Llave
- RO Cheie tubulara
- CN 六角套筒螺丝批

COLOR BOX



CrV HRC 44

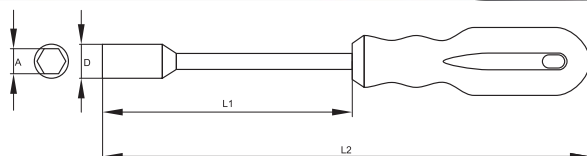

YATO	Ø (mm)	D (mm)	L1 (mm)	L2 (mm)	PCS packing:	
YT-1541	5	8.0	125	242	6	120
YT-1542	6	9.1	125	242	6	120
YT-1543	7	10.9	125	242	6	120
YT-1544	8	12.0	125	242	6	120
YT-1545	9	13.0	125	242	6	120
YT-1546	10	14.1	125	242	6	120
YT-1547	11	15.9	125	242	6	120
YT-1548	12	16.9	125	242	6	120
YT-1549	13	18.0	125	242	6	120

1

GB T-type deep socket wrench with rotary handle  
 D Steckschlüssel vom Typ „T“ mit drehbarem Handgriff  
 PL Klucz nasadowy typu „T” z obrotową rękojeścią  
 RUS Торцовый ключ типа „Т” с вращательной ручкой  
 CZ Klič nástrčný typ „T” s otočnou rukojeťou

H „T” típusú dugókulcs, forgatható karral  
 RO Cheie tubulară de tip „T” cu mâner rotativ  
 F Clé à tube  
 I Chiave tipo „T” con manico scorrevole  
 E Llave tubular „T” con un mango giratorio  
 CN T型套筒扳手



COLOR CARDBOARD

CrV 6140

AS-DRIVE

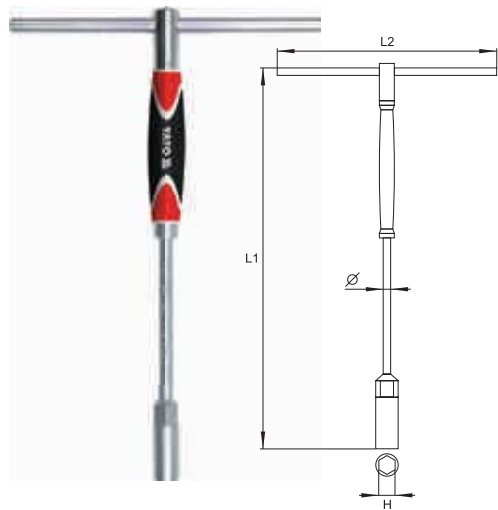

- ergonomic handle
- movable handle with position locking system
- long bar for work in deeply set, difficult to reach places

- ergonomiczna rękojeść
- przesuwane pokrętko z blokadą położenia
- długi trzpień umożliwiający pracę w głębokich wnękach

YATO	Ø H	L1 (mm)	L2 (mm)	Ø (mm)	
YT-1552	8 mm	310	200	10	10/40
YT-1553	9 mm	310	200	10	10/40
YT-1554	10 mm	310	200	10	10/40
YT-1555	11 mm	310	200	10	10/40
YT-1556	12 mm	310	200	10	10/40
YT-1557	13 mm	310	200	10	10/40
YT-1558	14 mm	310	200	10	10/40
YT-1559	15 mm	310	200	10	10/40

GB T-type deep socket wrench  
 D Steckschlüssel vom Typ „T”  
 PL Klucz nasadowy typu „T”  
 RUS Торцовый ключ типа „Т”  
 CZ Klič nástrčný typ „T”  
 H „T” típusú dugókulcs

RO Cheie tubulară de tip „T”  
 F Clé à tube en „T”  
 I Chiave a bussola tipo „T”  
 E Llave tubular „T”  
 CN T型套筒扳手

CrV 6140

AS-DRIVE

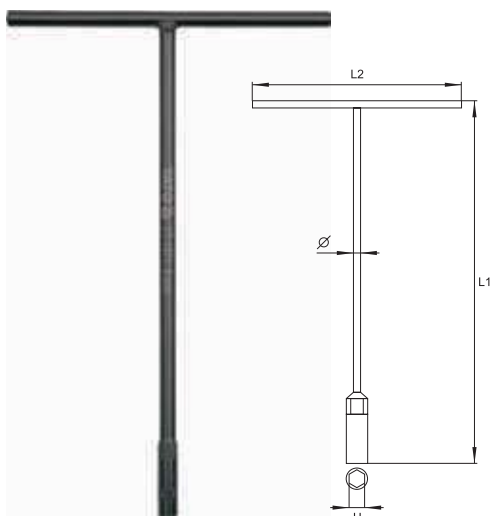

COLOR CARDBOARD



YATO	Ø H	L1 (mm)	L2 (mm)	Ø (mm)	
YT-1571	8 mm	310	200	10	10/40
YT-1572	9 mm	310	200	10	10/40
YT-1573	10 mm	310	200	10	10/40
YT-1574	11 mm	310	200	10	10/40
YT-1575	12 mm	310	200	10	10/40
YT-1576	13 mm	310	200	10	10/40
YT-1577	14 mm	310	200	10	10/40
YT-1578	15 mm	310	200	10	10/40

GB T-type adapter with rotary handle  
 D Adapter vom Typ „T” mit drehbarem Handgriff  
 PL Adapter typu „T” z obrotową rękojeścią  
 RUS Адаптер типа „Т” с вращательной ручкой  
 CZ Adaptér typ „T” s otočnou rukojeťou  
 H „T” típusú adapter, forgatható karral  
 RO Adaptor tip „T” cu mâner rotativ  
 F Adapteur  
 I Adattatore tipo „T” con manico scorrevole  
 E Adaptador „T” con un mango giratorio  
 CN T型套筒扳手



COLOR CARDBOARD

1/4" 3/8" 1/2"

6.3mm 10mm 12.5mm

CrV 6140

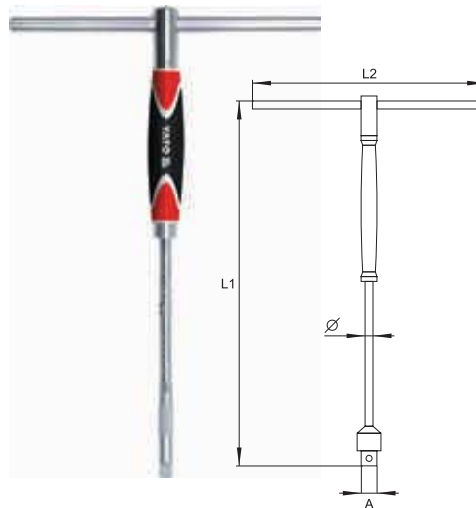

- ergonomic handle
- movable handle with position locking system
- long bar for work in deeply set, difficult to reach places

- ergonomiczna rękojeść
- przesuwane pokrętko z blokadą położenia
- długi trzpień umożliwiający pracę w głębokich wnękach

YATO	Ø H	L1 (mm)	L2 (mm)	Ø (mm)	
YT-1565	1/4" (6.3 mm)	310	200	8	10/40
YT-1566	3/8" (9.5 mm)	310	200	10	10/40
YT-1567	1/2" (12.7 mm)	310	200	10	10/40

GB Y-type socket wrench  
 D Steckschlüssel vom Typ „Y”  
 PL Klucz nasadowy typu „Y”  
 RUS Торцовый ключ типа „Y”  
 CZ Klič nástrčný typ „Y”  
 H „Y” típusú dugókulcs

RO Cheie tubulară de tip „Y”  
 F Clé à tube en „Y”  
 I Chiave a bussola tipo „Y”  
 E Llave tubular „Y”  
 CN Y型套筒扳手

CrV 6140

AS-DRIVE



COLOR CARDBOARD



YATO	Ø H	L (mm)	Ø (mm)	
YT-1586	12-14-17 mm	140	10	10/40

GB Adjustable wrench  
D Rollgabelschlüssel  
PL Klucz nastawny  
RUS Ключ разводной

CZ Nastavitelný klíč  
H Állítható svédkulcs  
RO Cheie reglabilă  
F Clé à molette

I Chiave a rullino graduata  
E Llave ajustable  
tipo inglesa  
CN 活络扳手

150 mm 200 mm 250 mm 300 mm 375 mm

1



HALF  
DOUBLE  
BLISTER

YATO	L (mm)	
YT-2071	150	6/60
YT-2072	200	6/60
YT-2073	250	6/36
YT-2074	300	6/24
YT-2075	375	6/12

GB Adjustable wrench  
D Rollgabelschlüssel  
PL Klucz nastawny  
RUS Ключ разводной

CZ Nastavitelný klíč  
H Állítható svédkulcs  
RO Cheie reglabilă  
F Clé à molette

I Chiave a rullino graduata  
E Llave ajustable  
tipo inglesa  
CN 活络扳手

150 mm 200 mm 250 mm 300 mm DIN 3117 CrV



HALF  
DOUBLE  
BLISTER

YATO	L (mm)	
YT-2165	150	6/120
YT-2166	200	6/60
YT-2167	250	6/36
YT-2168	300	6/24

GB Adjustable wrench  
D Rollgabelschlüssel  
PL Klucz nastawny  
RUS Ключ разводной

CZ Nastavitelný klíč  
H Állítható svédkulcs  
RO Cheie reglabilă  
F Clé à molette

I Chiave a rullino graduata  
E Llave ajustable  
tipo inglesa  
CN 活络扳手

150 mm 200 mm 250 mm 300 mm DIN 3117 CrV



HALF  
DOUBLE  
BLISTER

YATO	L (mm)	
YT-2170	150	6/72
YT-2171	200	6/60
YT-2172	250	6/48
YT-2173	300	6/36

GB Adjustable wrench  
D Rollgabelschlüssel  
PL Klucz nastawny  
RUS Ключ разводной

CZ Nastavitelný klíč  
H Állítható svédkulcs  
RO Cheie reglabilă  
F Clé à molette

I Chiave a rullino graduata  
E Llave ajustable  
tipo inglesa  
CN 活络扳手

150 mm 200 mm 250 mm 300 mm 375 mm DIN 3117 DROP FORGED KUTE



HALF  
DOUBLE  
BLISTER

YATO	L (mm)	opening capacity (mm) zakres rozwarcia szczęk (mm)	
YT-21650	150	19.3	6/36
YT-21651	200	24.0	6/36
YT-21652	250	30.0	6/36
YT-21653	300	36.0	6/24
YT-21654	375	45.0	2/16

# 2

## Sockets, accessories & sets Klucze nasadowe, akcesoria i zestawy





**Sockets 1/4"**  
**Klucze nasadowe 1/4"**

27



Bit adapters	Adaptery do bitów.....	32
Universal joints	Przeguby Cardana.....	32
Sliding T-bars	Pokręta typu „T”.....	32
Flexible handles	Pokręta łamane.....	32
Spark plug sockets	Klucze nasadowe do świec.....	32

Hexagonal sockets	Klucze nasadowe sześciokątne, krótkie.....	27
Hexagonal deep sockets	Klucze nasadowe sześciokątne, długie.....	27

**Accessories 1/4"**  
**Akcesoria 1/4"**

27-28



**Ratchet handles 3/8"**  
**Grzechotki 3/8"**

33-34



Extension bars	Przedłużki.....	27
Extension bars with wobble	Przedłużki uchylnie.....	27
Flexible extension cords	Przedłużki elastyczne.....	28
Adapters	Redukcje.....	28
Bit adapters	Adaptery do bitów.....	28
Universal joints	Przeguby Cardana.....	28
Spinner handles	Pokręta do nasadek.....	28
Sliding T-bars	Pokręta typu „T”.....	28
Flexible handles	Pokręta łamane.....	28

Ratchet handles	Grzechotki.....	33
Flexible ratchet handles	Grzechotki z przegubem.....	33
Composite ratchet handles	Grzechotki powlekane.....	33
Curved ratchet handles	Grzechotki wygięte.....	34
Telescopic ratchet handles	Grzechotki z przedłużonym uchwytem.....	34

**Ratchet handles 1/4"**  
**Grzechotki 1/4"**

29-30



**Sockets 1/2"**  
**Klucze nasadowe 1/2"**

35-36



Ratchet handles	Grzechotki.....	29
Flexible ratchet handles	Grzechotki z przegubem.....	29
Composite ratchet handles	Grzechotki powlekane.....	29
Curved ratchet handles	Grzechotki wygięte.....	30
Telescopic ratchet handles	Grzechotki z przedłużonym uchwytem.....	30
Bit and socket drive ratchet handles	Grzechotki do bitów i nasadek.....	30
Rotary head ratchet handles	Grzechotki z obrotową głowicą.....	30

Hexagonal sockets	Klucze nasadowe sześciokątne, krótkie.....	35
Bi-hexagonal sockets	Klucze nasadowe dwunastokątne, krótkie.....	35
Spline sockets	Klucze nasadowe „Spline”.....	35
Hexagonal deep sockets	Klucze nasadowe sześciokątne, długie.....	36

**Sockets 3/8"**  
**Klucze nasadowe 3/8"**

31



**Accessories 1/2"**  
**Akcesoria 1/2"**

36-37



Hexagonal sockets	Klucze nasadowe sześciokątne, krótkie.....	31
Hexagonal deep sockets	Klucze nasadowe sześciokątne, długie.....	31

Extension bars	Przedłużki.....	36
Extension bars with wobble	Przedłużki uchylnie.....	36
Adapters	Redukcje.....	37
Bit adapters	Adaptery do bitów.....	37
Universal joints	Przeguby Cardana.....	37
Sliding T-bars	Pokręta typu „T”.....	37
Flexible handles	Pokręta łamane.....	37
L-type handles	Pokręta typu „L”.....	37
Spark plug sockets	Klucze nasadowe do świec.....	37

**Accessories 3/8"**  
**Akcesoria 3/8"**

31-32



**Ratchet handles 1/2"**  
**Grzechotki 1/2"**







38-39



Extension bars	Przedłużki.....	31
Extension bars with wobble	Przedłużki uchylnie.....	31
Adapters	Redukcje.....	32

Ratchet handles	Grzechotki.....	38
Flexible ratchet handles	Grzechotki z przegubem.....	38



<b>Composite ratchet handles</b> Grzechotki powlekane.....		38	<b>Go-trough socket sets 1/2"</b> Zestawy kluczy nasadowych, przelotowych 1/2"		
<b>Curved ratchet handles</b> Grzechotki wygięte.....		39			
<b>Telescopic ratchet handles</b> Grzechotki z przedłużonym uchwytem.....		39			
<b>Rotary head ratchet handles</b> Grzechotki z obrotową głowicą.....		39	<b>Sockets 3/4"</b> Klucze nasadowe 3/4"		
<b>Socket sets</b> Zestawy kluczy nasadowych		40-50	<b>Accessories 3/4"</b> Akcesoria 3/4"		
<b>Socket sets 1/4"</b> Zestawy kluczy nasadowych 1/4".....		40			
<b>Socket sets 3/8"</b> Zestawy kluczy nasadowych 3/8".....		41	<b>Extension bars</b> Przedłużki.....		71
<b>Socket sets 1/2"</b> Zestawy kluczy nasadowych 1/2".....		42	<b>Adapters</b> Redukcje.....		71
<b>Socket sets 1/2", 1/4"</b> Zestawy kluczy nasadowych 1/2", 1/4".....		43	<b>Universal joints</b> Przeguby Cardana.....		71
<b>Socket sets 1/2", 3/8", 1/4"</b> Zestawy kluczy nasadowych 1/2", 3/8", 1/4".....		46	<b>Sliding T-bars</b> Pokręta typu „T”.....		71
<b>Socket sets</b> Zestawy kluczy nasadowych		51-69	<b>Flexible handles</b> Pokręta łamane.....		72
			<b>L-type handles</b> Pokręta typu „L”.....		72
<b>Socket sets 1/4"</b> Zestawy kluczy nasadowych 1/4".....		51	<b>Ratchet handles 3/4"</b> Grzechotki 3/4"		
<b>Socket sets 3/8"</b> Zestawy kluczy nasadowych 3/8".....		55			
<b>Socket sets 1/2"</b> Zestawy kluczy nasadowych 1/2".....		57	<b>Socket sets 3/4"</b> Zestawy kluczy nasadowych 3/4"		
<b>Socket sets 1/2", 1/4"</b> Zestawy kluczy nasadowych 1/2", 1/4".....		61			
<b>Socket sets 1/2", 3/8", 1/4"</b> Zestawy kluczy nasadowych 1/2", 3/8", 1/4".....		66			
<b>Torx sockets &amp; sets</b> Klucze nasadowe „Torx” i zestawy		70	<b>Bit sockets &amp; sets 1/4", 3/8", 1/2"</b> Klucze trzpieniowe i zestawy 1/4", 3/8", 1/2"		
					73-75

GB Hexagonal socket  
 D Sechskantenschlüssel  
 PL Nasadka sześciokątna  
 RUS Головка шестигранная короткая  
 CZ Šestihřanný nástavec  
 H Hatszögű rátét mély  
 RO Cheie tubulară hexagonală  
 F Douille courte  
 I Chiave a bussola esagonale  
 E Boquilla hexagonal corta  
 CN 六角套筒

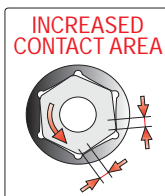

1/4"  
 6.3mm  
 DIN 3121  
 CrV 50BV30  
 AS-DRIVE

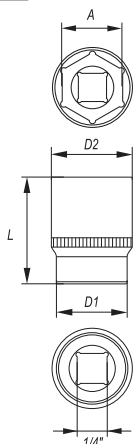

- drive locks
- surface finish: chromed, satin / mirror
- zamki blokujące
- wykończenie powierzchni: chromowana, satynowa / polerowana

YATO	∅ A (mm)	D1 (mm)	D2 (mm)	L (mm)	PCS packing	
YT-1401	4.0	7.0	12.0	25	20	200/400
YT-1403	5.0	8.0	12.0	25	20	200/400
YT-1404	5.5	8.5	12.0	25	20	200/400
YT-1405	6.0	9.0	12.0	25	20	200/400
YT-1406	7.0	10.0	12.0	25	20	200/400
YT-1407	8.0	12.0	11.0	25	20	200/400
YT-1408	9.0	13.0	12.0	25	20	200/400
YT-1409	10.0	15.0	12.0	25	10	200/400
YT-1410	11.0	16.0	14.0	25	10	200/400
YT-1411	12.0	17.0	15.0	25	10	200/400
YT-1412	13.0	18.0	16.0	25	10	200/400

GB Hexagonal deep socket  
 D Sechskantenschlüssel, lange  
 PL Nasadka sześciokątna długa  
 RUS Головка шестигранная длинная  
 CZ Šestihřanný hluboký nástavec  
 H Hatszögű rátét mély  
 RO Cheie tubulară hexagonală adâncă  
 F Douille longue  
 I Chiave a bussola esagonale  
 E Boquilla hexagonal larga  
 CN 六角长套筒

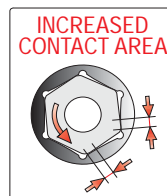

1/4"  
 6.3mm  
 DIN 3121  
 CrV 50BV30  
 AS-DRIVE

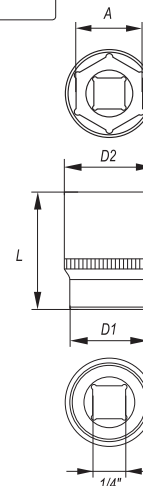

- drive locks
- surface finish: chromed, satin / mirror
- zamki blokujące
- wykończenie powierzchni: chromowana, satynowa / polerowana

YATO	∅ A (mm)	D1 (mm)	D2 (mm)	L (mm)	PCS packing	
YT-1413	4.0	7.0	12.0	50	10	200/400
YT-1414	4.5	7.5	12.0	50	10	200/400
YT-1415	5.0	8.0	12.0	50	10	200/400
YT-1416	5.5	8.5	12.0	50	10	200/400
YT-1417	6.0	9.0	12.0	50	10	200/400
YT-1418	7.0	10.0	12.0	50	10	200/400
YT-1419	8.0	12.0	12.0	50	10	200/400
YT-1420	9.0	13.0	12.0	50	10	200/400
YT-1421	10.0	14.0	13.0	50	10	200/400
YT-1422	11.0	16.0	14.0	50	10	100/200
YT-1423	12.0	17.0	15.0	50	10	100/200
YT-1424	13.0	18.0	16.0	50	10	100/200

GB Extension bar  
 D Verlängerung  
 PL Przedłużka  
 RUS Удлинитель для воротка  
 CZ Prodlužovací přípravek  
 H Toldalék  
 RO Prelungitor  
 F Rallonge  
 I Prolunga  
 E Tubo de prolongación  
 CN 接杆

1/4"  
 6.3mm  
 DIN 3121  
 CrV 50BV30

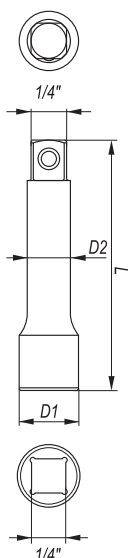

YATO	∅	D1 (mm)	D2 (mm)	L (mm)	PCS packing	
YT-1429	1/4" (6.3 mm)	12.4	8.3	50.8	30	150/300
YT-1430	1/4" (6.3 mm)	12.4	8.3	76.0	30	150/300
YT-1431	1/4" (6.3 mm)	12.4	8.3	101.6	20	100/200
YT-1432	1/4" (6.3 mm)	12.4	8.3	152.4	20	100/200

GB Extension bar with wobble  
 D Gelenkverlängerung  
 PL Przedłużka uchylna  
 RUS Удлинитель наклонный  
 CZ Odchylný prodlužovací přípravek  
 H Csuklós toldalék  
 RO Prelungitor rabatabil  
 F Rallonge angulaire  
 I Prolunga  
 E Tubo de prolongación desviable  
 CN 转向接杆

1/4"  
 6.3mm  
 DIN 3121  
 CrV 50BV30

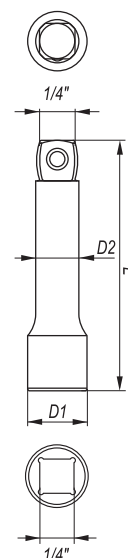

YATO	∅	D1 (mm)	D2 (mm)	L (mm)	PCS packing	
YT-1433	1/4" (6.3 mm)	12.4	8.3	50.8	30	150/300
YT-1434	1/4" (6.3 mm)	12.4	8.3	76.0	30	150/300
YT-1435	1/4" (6.3 mm)	12.4	8.3	101.6	20	100/200
YT-1436	1/4" (6.3 mm)	12.4	8.3	152.4	20	100/200

- |                            |                           |                        |
|----------------------------|---------------------------|------------------------|
| GB Extension bar           | CZ Prodlužovací přípravek | I Prolunga flessibile  |
| D Verlängerung             | H Toldalék                | E Tubo de prolongación |
| PL Przedłużka elastyczna   | RO Prelungitor            | CN 可弯式接杆               |
| RUS Удлинитель для воротка | F Rallonge élastique      |                        |

1/4" CrV  
6.3mm 6140

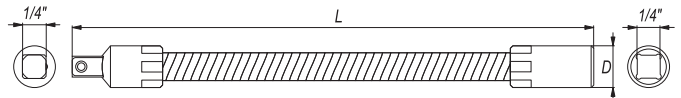

YATO	Ø	Ø	D (mm)	L (mm)	PCS packing	Box
YT-1400	1/4" (6.3 mm)	1/4" (6.3 mm)	11.6	150	25	250/500

- |                |                |
|----------------|----------------|
| GB Adapter     | PL Redukcja    |
| D Reduktion    | RUS Переходник |
| PL Redukcja    | CZ Redukce     |
| RUS Переходник | H Redukció     |
| CZ Redukce     | F Réduction    |
| H Redukció     | I Riduttore    |
| F Réduction    | E Reducción    |
| I Riduttore    | CN 转换头         |
| E Reducción    |                |
| CN 转换头         |                |

1/4" DIN 3121 CrV  
6.3mm 50BV30

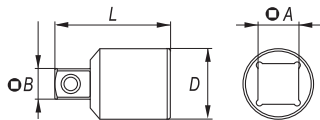

COLOR BOX

YATO	Ø A	Ø B	D (mm)	L (mm)	PCS packing	Box
YT-1438	1/4" (6.3 mm) (F)	3/8" (9.5 mm) (M)	12	25	10	250/500

- |  |                                     |
|--|-------------------------------------|
| GB Bit adapter                           | RO Drăzak na șroubovackové koncovky |
| D Bithalter                              | H Szár a csavarhúzóvégekhez         |
| PL Adapter do bitów                      | RO Capete șurubelniță               |
| RUS Держатель винтовёртовых наконечников | F Adapteur d'embouts                |
| CZ Držák na šroubovackové koncovky       | I Chiave esagonale a bussola        |
| H Szár a csavarhúzóvégekhez              | E Mandril para puntas               |
| RO Capete șurubelniță                    | CN 旋具头接头                            |
| F Adapteur d'embouts                     |                                     |
| I Chiave esagonale a bussola             |                                     |
| E Mandril para puntas                    |                                     |
| CN 旋具头接头                                 |                                     |

1/4" CrV  
6.3mm 6140

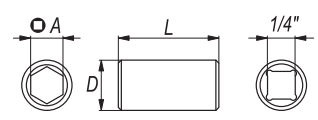

COLOR BOX

YATO	Ø	Ø A	D (mm)	L (mm)	PCS packing	Box
YT-1297	1/4" (6.3 mm)	1/4" (6.3 mm)	11.8	24	10	250/500

- |                      |                          |
|----------------------|--------------------------|
| GB Universal joint   | RO Articulație Cardanică |
| D Kardangelen        | F Cardan                 |
| PL Przegub Cardana   | I Snodo cardanico        |
| RUS Карданный шарнир | E Articulación Cardan    |
| CZ Kardanový kloub   | CN 万向接头                  |
| H Kárdán csukló      |                          |

1/4" DIN 3121 CrV  
6.3mm 50BV30

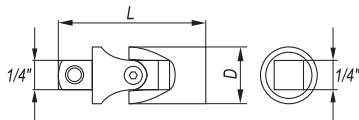

COLOR BOX

YATO	Ø	D (mm)	L (mm)	PCS packing	Box
YT-1437	1/4" (6.3 mm)	14	35	20	120/240

- |                                     |                                  |
|-------------------------------------|----------------------------------|
| GB Spinner handle                   | RO Prelungitor antrenor pt. biti |
| D Drehgriff für steckschlüssel      | F Barre                          |
| PL Pokrętko do nasadek              | I Porta bussola con manico       |
| RUS Ручка с соединением под головки | E Destornillador con cuadradillo |
| CZ Nástavec ruční na bity           | CN 旋柄                            |
| H Csavarhúzó hajtószer              |                                  |

1/4" CrV  
6.3mm 50BV30



COLOR BOX

YATO	Ø	L (mm)	PCS packing	Box
YT-1427	1/4" (6.3 mm)	150	12	48

- |                            |                           |
|----------------------------|---------------------------|
| GB Sliding T-bar           | H „T” alakú hajtókar      |
| D Handgriff mit Gleitstück | RO Mâner clupă tipul „T”  |
| PL Pokrętko typu „T”       | F Barre type „T”          |
| RUS Вороток Т-образный     | I Manopola „T” scorrevole |
| CZ Otočná račká typ „T”    | E Mango tipo „T”          |
|                            | CN 滑行杆                    |

1/4" DIN 3121 CrV  
6.3mm 50BV30

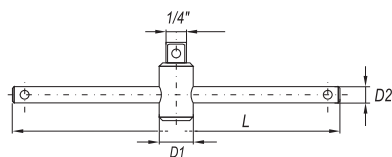

COLOR BOX

YATO	Ø	D1 (mm)	D2 (mm)	L (mm)	PCS packing	Box
YT-1426	1/4" (6.3 mm)	13.3	6.3	152.4	10	100/200

- |                        |                                      |
|------------------------|--------------------------------------|
| GB Flexible handle     | RO Prelungitor cu prindere flexibilă |
| D Gelenkgriff          | F Barre pivotante                    |
| PL Pokrętko lamane     | I Manopola a snodo                   |
| RUS Вороток шарнирный  | E Mango articulado                   |
| CZ Otočná lomená ráčka | CN 转向手柄                              |
| H Hajlított hajtókar   |                                      |

1/4" DIN 3121 CrV  
6.3mm 50BV30

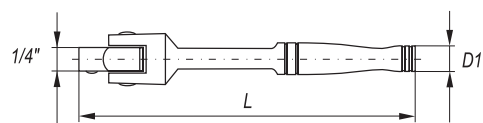

COLOR BOX

YATO	Ø	D (mm)	L (mm)	PCS packing	Box
YT-1425	1/4" (6.3 mm)	13	140	10	100/200

GB Quick release ratchet handle  
 D Hebelumschaltknarre  
 PL Grzechotka  
 RUS Трещотка  
 CZ Řehtačka  
 H Racsnis hajtókar

RO Dispozitiv de prindere cu clichet  
 F Clé à cliquet  
 I Cricchetto bussola  
 E Carraca  
 CN 快速脱落棘轮扳手

PLASTIC HANGER



12 PCS



COLOR BOX

1/4"  
6.3mm

DIN  
3122

QUICK  
RELEASE  
SZYBKO-  
ZŁĄCZE

72T

CrV  
6140



YATO	Ø	T	L (mm)	PCS packing:	
YT-0307	1/4" (6.3 mm)	72	146	12	24/96

YATO	Ø	T	L (mm)	PCS packing:	
YT-0310	1/4" (6.3 mm)	72	125	12	36/72

YATO	Ø	T	L (mm)	PCS packing:	
YT-0313	1/4" (6.3 mm)	72	125	12	24/96



YATO	Ø	T	L (mm)	PCS packing:	
YT-0316	1/4" (6.3 mm)	72	145	12	24/96

YATO	Ø	T	L (mm)	PCS packing:	
YT-0319	1/4" (6.3 mm)	72	145	12	48/96

YATO	Ø	T	L (mm)	PCS packing:	
YT-0322	1/4" (6.3 mm)	72	148	12	48/96

GB Quick release ratchet handle  
 D Hebelumschaltknarre  
 PL Grzechotka  
 RUS Трещотка  
 CZ Řehtačka  
 H Racsnis hajtókar

RO Dispozitiv de prindere cu clichet  
 F Clé à cliquet  
 I Cricchetto bussola  
 E Carraca  
 CN 快速脱落棘轮扳手

PLASTIC HANGER



12 PCS



COLOR BOX

1/4"  
6.3mm

QUICK  
RELEASE  
SZYBKO-  
ZŁĄCZE

DIN  
3122

72T

CrV  
6140

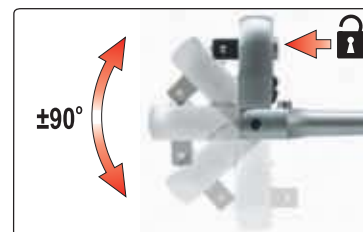

YATO	Ø	T	L (mm)	PCS packing:	
YT-0325	1/4" (6.3 mm)	72	159	12	48/96

GB Quick release ratchet handle  
 D Hebelumschaltknarre  
 PL Grzechotka powlekana  
 RUS Трещотка  
 CZ Řehtačka  
 H Racsnis hajtókar

RO Dispozitiv de prindere cu clichet  
 F Clé à cliquet  
 I Cricchetto bussola  
 E Carraca  
 CN 快速脱落棘轮扳手

PLASTIC HANGER



12 PCS



COLOR BOX

1/4"  
6.3mm

DIN  
3122

QUICK  
RELEASE  
SZYBKO-  
ZŁĄCZE

72T

CrV  
6135



YATO	Ø	T	L (mm)	PCS packing:	
YT-0290	1/4" (6.3 mm)	72	144	12	48/96

YATO	Ø	T	L (mm)	PCS packing:	
YT-0293	1/4" (6.3 mm)	72	144	12	48/96

GB Quick release ratchet handle  
 D Hebelumschaltknarre  
 PL Grzechotka  
 RUS Трещотка  
 CZ Řehtačka  
 H Racsnis hajtókar  
 RO Dispozitiv de prindere cu clichet  
 F Clé à cliquet  
 I Cricchetto bussola  
 E Carraca  
 CN 快速脱落棘轮扳手

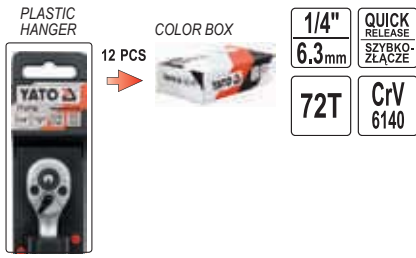

GB Quick release ratchet handle  
 D Hebelumschaltknarre  
 PL Grzechotka  
 RUS Трещотка  
 CZ Řehtačka  
 H Racsnis hajtókar  
 RO Dispozitiv de prindere cu clichet  
 F Clé à cliquet  
 I Cricchetto bussola  
 E Carraca  
 CN 快速脱落棘轮扳手

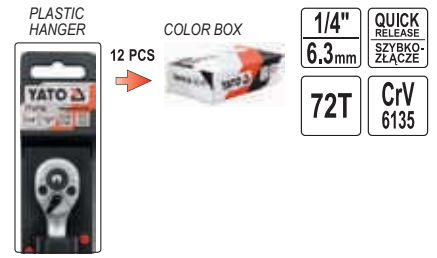

YATO	Ø	T	L (mm)	PCS packing:	
YT-0730	1/4" (6.3 mm)	72	155	12	24/96

YATO	Ø	T	L (mm)	PCS packing:	
YT-0733	1/4" (6.3 mm)	72	155	12	24/96

GB Telescopic ratchet handle  
 D Umschaltknarre  
 PL Grzechotka z przedłużanym uchwytem  
 RUS Трещотка  
 CZ Řehtačka  
 H Racsnis hajtókar  
 RO Antrenor cu clichet  
 F Clé à cliquet  
 I Cricchetto bussola  
 E Carraca telescópico  
 CN 可伸缩快速脱落棘轮扳手

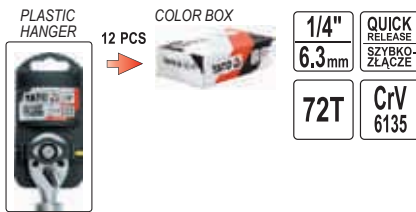

GB Ratchet handle and bit drive  
 D Bit- und Steckschlüssel-Umschaltknarre  
 PL Grzechotka do bitów i nasadek  
 RUS Трещотка для битов и головок  
 CZ Ráčna kombinovaná pro bity a nástřnné kľíče  
 H Bit és dugófej behajtó racsnis hajtókar  
 RO Antrenor cu clichet / antrenor pt. biti  
 F Clé à cliquet  
 I Cricchetto bussola per punte e snodi  
 E Carraca para boquillas y puntas  
 CN 套筒旋具两用棘轮扳手

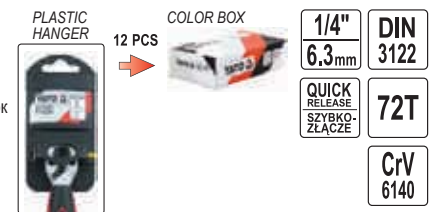

YATO	Ø	T	L (mm)	PCS packing:	
YT-0297	1/4" (6.3 mm)	72	150-200	12	48

YATO	Ø	T	L (mm)	PCS packing:	
YT-0331	1/4" (6.3 mm)	72	136	12	48

GB Swivel ratchet handle for bits and sockets  
 D Umschaltknarre mit Außenvierkanttrieb  
 PL Grzechotka z obrotową głowicą do bitów i nasadek  
 RUS Трещетка реверсивная  
 CZ Ráčna s otočnou hlavou  
 H Forgófejes racsnis szár  
 RO Antrenor cu clichet flexibil  
 F Cricchetto bussola per punte e snodi  
 I Cricchetto bussola per punte e snodi  
 E Carraca con cabeza giratoria  
 CN 旋轉頭套筒旋具兩用棘輪扳手

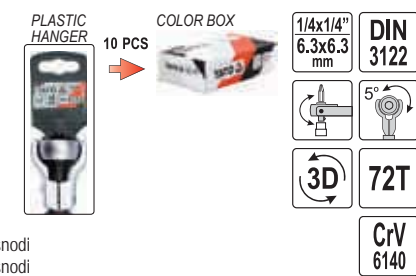

GB Flexible ratchet handle / round head  
 D Flexible Drehkopfratsche  
 PL Grzechotka z obrotową głowicą  
 RUS Трещетка с вращательной головкой  
 CZ Ráčna s otočnou hlavou  
 H Forgófejes racsnis szár  
 RO Antrenor cu clichet flexibil  
 F Clé à cliquet tête pivotante  
 I Cricchetto bussola reversibile con ghiera  
 E Carraca con cabeza giratoria  
 CN 旋转头快速脱落棘轮扳手

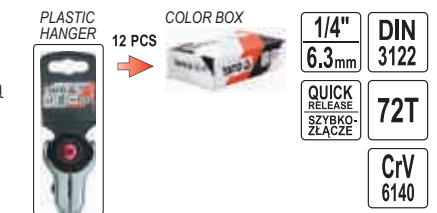

YATO	Ø	T	L (mm)	PCS packing:	
YT-03311	1/4" (6.3 mm) x 1/4" (6.3 mm)	72	115	10	100

YATO	Ø	T	L (mm)	PCS packing:	
YT-0720	1/4" (6.3 mm)	72	145	12	24/96

GB Hexagonal socket  
 D Sechskantenschlüssel  
 PL Nasadka sześciokątna  
 RUS Головка шестигранная короткая  
 CZ Šestihřanný nástavec  
 H Hatszögű rátét  
 RO Cheie tubulară hexagonală  
 F Douille courte  
 I Chiave a bussola esagonale  
 E Boquilla hexagonal corta  
 CN 六角套筒

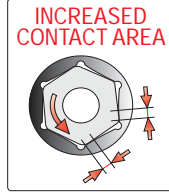
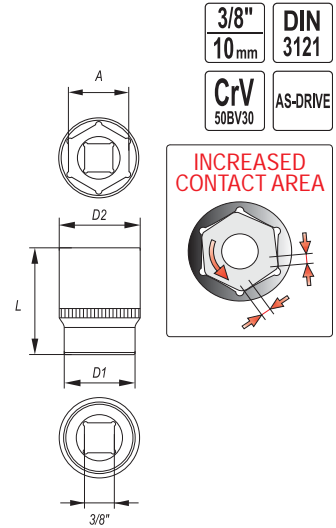

- drive locks
- surface finish: chromed, satin / mirror

- zamki blokujące
- wykończenie powierzchni: chromowana, satynowa / polerowana



YATO	∅ A (mm)	D1 (mm)	D2 (mm)	L (mm)	PCS packing:	
YT-3801	6	10	17	28	10	250/500
YT-3802	7	11	17	28	10	250/500
YT-3803	8	12	17	28	10	250/500
YT-3804	9	13	17	28	10	250/500
YT-3805	10	14	17	28	10	250/500
YT-3806	11	16	17	28	10	250/500
YT-3807	12	18	17	28	10	250/500
YT-3808	13	19	18	28	10	150/300
YT-3809	14	20	19	28	10	150/300
YT-3810	15	21	19	28	10	100/500
YT-3811	16	22	21	28	10	100/500
YT-3812	17	24	22	30	10	100/200
YT-3813	18	25	23	30	10	100/200
YT-3814	19	26	24	30	10	100/200

GB Hexagonal deep socket  
 D Sechskantenschlüssel, lange  
 PL Nasadka sześciokątna długa  
 RUS Головка шестигранная длинная  
 CZ Šestihřanný hluboký nástavec  
 H Hatszögű rátét mély  
 RO Cheie tubulară hexagonală adâncă  
 F Douille longue  
 I Chiave a bussola esagonale  
 E Boquilla hexagonal larga  
 CN 六角长套筒

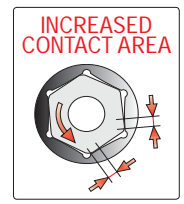
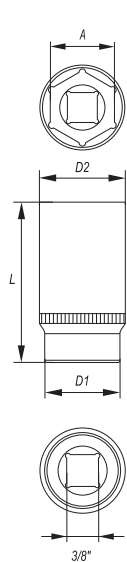

- drive locks
- surface finish: chromed, satin / mirror

- zamki blokujące
- wykończenie powierzchni: chromowana, satynowa / polerowana



YATO	∅ A (mm)	D1 (mm)	D2 (mm)	L (mm)	PCS packing:	
YT-3820	6	10	17	63	10	50/100
YT-3821	7	10	17	63	10	50/100
YT-3822	8	12	17	63	10	50/100
YT-3823	9	13	17	63	10	50/100
YT-3824	10	14	17	63	10	50/100
YT-3825	11	16	17	63	10	50/100
YT-3826	12	18	17	63	10	50/100
YT-3827	13	19	17	63	10	50/100
YT-3828	14	20	19	63	10	50/100
YT-3829	15	21	19	63	10	50/100
YT-3830	16	22	20	63	10	50/100
YT-3831	17	24	23	63	10	50/100
YT-3832	18	25	23	63	10	50/100
YT-3833	19	26	24	63	10	50/100

GB Extension bar  
 D Verlängerung  
 PL Przedłużka  
 RUS Удлинитель для воротка  
 CZ Prodlužovací přípravek  
 H Toldalék  
 RO Prelungitor  
 F Rallonge  
 I Prolunga  
 E Tubo de prolongación  
 CN 接杆

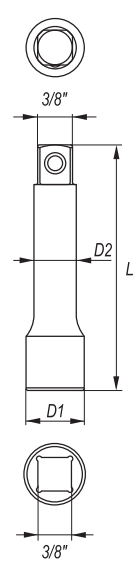

3/8"  
 10mm  
 DIN 3121  
 CrV 50BV30



YATO	∅	D1 (mm)	D2 (mm)	L (mm)	PCS packing:	
YT-3842	3/8" (9.5 mm)	18.0	12.3	42.0	10	100/200
YT-3843	3/8" (9.5 mm)	18.0	12.3	76.0	10	100/200
YT-3844	3/8" (9.5 mm)	18.0	12.3	152.4	10	50/100
YT-3845	3/8" (9.5 mm)	18.0	12.3	254.0	10	50

GB Extension bar with wobble  
 D Gelenkverlängerung  
 PL Przedłużka uchylna  
 RUS Удлинитель наклонный  
 CZ Odchylný prodlužovací přípravek  
 H Csuklós toldalék  
 RO Prelungitor rabatabil  
 F Rallonge angulaire  
 I Prolunga  
 E Tubo de prolongación desviable  
 CN 转向接杆

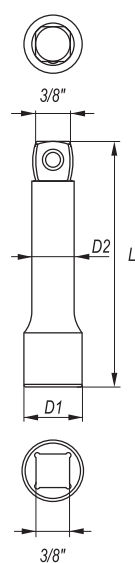

3/8"  
 10mm  
 DIN 3121  
 CrV 50BV30



YATO	∅	D1 (mm)	D2 (mm)	L (mm)	PCS packing:	
YT-3847	3/8" (9.5 mm)	18.0	12.3	76.0	10	100/200
YT-3848	3/8" (9.5 mm)	18.0	12.3	152.4	10	50/100
YT-3849	3/8" (9.5 mm)	18.0	12.3	254.0	10	50

- GB Adapter
- D Reduktion
- PL Redukcja
- RUS Переходник
- CZ Redukce
- H Redukció
- RO Reducție
- F Réduction
- I Riduttore
- E Reducción
- CN 转换头

3/8" 10mm  
DIN 3121  
CrV 50BV30

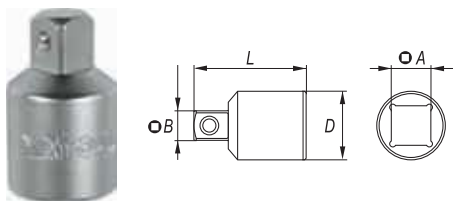

COLOR BOX

YATO	Ø A	Ø B	D (mm)	L (mm)	PCS packing	
YT-3853	3/8" (9.5 mm) (F)	1/4" (6.3 mm) (M)	17	27	10	250/500
YT-3854	3/8" (9.5 mm) (F)	1/2" (12.7 mm) (M)	17	35	10	100/200

- GB Universal joint
- D Kardangelenk
- PL Przegub Cardana
- RUS Карданный шарнир
- CZ Kardanový kloub
- H Kardan csukló

- RO Articulație Cardanică
- F Cardan
- I Snodo cardanico
- E Articulación Cardan
- CN 万向接头

3/8" 10mm  
DIN 3121  
CrV 50BV30

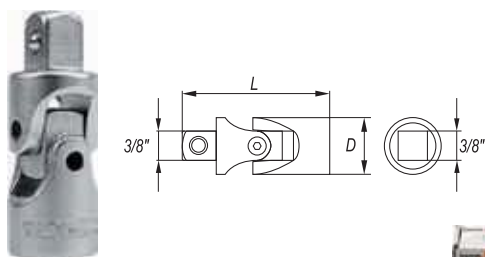

COLOR BOX

YATO	Ø	D (mm)	L (mm)	PCS packing	
YT-3850	3/8" (9.5 mm)	18	49	10	100/200

- GB Flexible handle
- D Gelenkgriff
- PL Pokręto łamane
- RUS Вороток шарнирный
- CZ Otočná lomená ráčka
- H Hajlított hajtókar
- RO Prelungitor cu prindere flexibilă
- F Barre pivotante
- I Manopola a snodo
- E Mango articulado
- CN 转向手柄

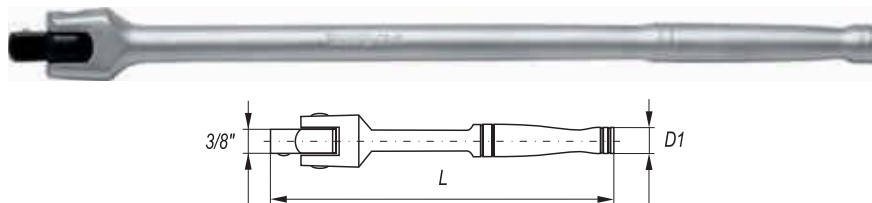

3/8" 10mm  
DIN 3121  
CrV 50BV30

COLOR BOX

YATO	Ø	D (mm)	L (mm)	PCS packing	
YT-3839	3/8" (9.5 mm)	16	215	8	24/48

- GB Spark plug socket
- D Steckschlüssel mit Gummihalterung
- PL Nasadka do świec
- RUS Головка свечная
- CZ Nastavec pro svíčky

- H Gyújtógyertya toldalék
- RO Cheie de bujii
- F Douille à bougies
- I Chiavi a bussola
- E Boquilla de bujías
- CN 六角火花塞套筒

3/8" 10mm  
DIN 3121  
AS-DRIVE CrV 50BV30

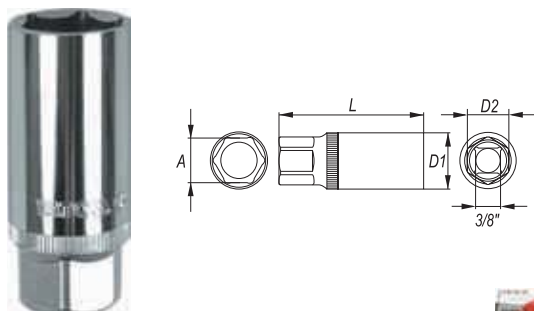

COLOR BOX

YATO	Ø	A	D1 (mm)	D2 (mm)	L (mm)	PCS packing	
YT-3851	3/8" (9.5 mm)	16.0	22.0	19.0	64.0	10	50/100

- GB Bit adapter
- D Bithalter
- PL Adapter do bitów
- RUS Держатель винтовёртовых наконечников
- CZ Držák na šroubovakové koncovky
- H Szár a csavarhúzóvégekhez
- RO Capete şurubelniţă
- F Adapteur d'embouts
- I Chiave esagonale a bussola
- E Mandril para puntas
- CN 旋具头接头

3/8" 10mm  
CrV 6140

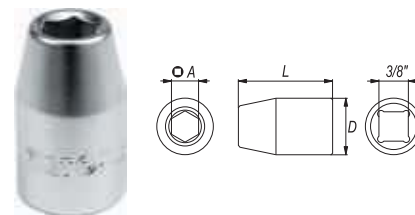

COLOR BOX

YATO	Ø	Ø A	D (mm)	L (mm)	PCS packing	
YT-1296	3/8" (9.5 mm)	8 mm	17.9	30	10	250/500

- GB Sliding T-bar
- D Handgriff mit Gleitstück
- PL Pokręto typu „T”
- RUS Вороток Т-образный

- CZ Otočná ráčka typ „T”
- H „T” alakú hajtókar
- RO Mâner clupă tipul „T”
- F Barre type „T”

- I Manopola „T” scorrevole
- E Mango tipo „T”
- CN 滑行杆

3/8" 10mm

DIN 3121

CrV 50BV30

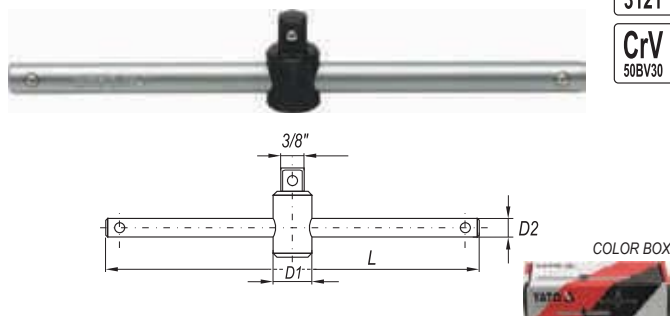

COLOR BOX

YATO	Ø	D1 (mm)	D2 (mm)	L (mm)	PCS packing	
YT-3840	3/8" (9.5 mm)	20.0	10.7	198	10	50/100

- GB Spark plug socket
- D Steckschlüssel mit Gummihalterung
- PL Nasadka do świec
- RUS Головка свечная
- CZ Nastavec pro svíčky

- H Gyújtógyertya toldalék
- RO Cheie de bujii
- F Douille à bougies
- I Chiavi a bussola
- E Boquilla de bujías
- CN 六角火花塞套筒

3/8" 10mm  
DIN 3121  
AS-DRIVE CrV 50BV30

- GB Spark plug socket
- D Steckschlüssel mit Gummihalterung
- PL Nasadka do świec
- RUS Головка свечная
- CZ Nastavec pro svíčky

- H Gyújtógyertya toldalék
- RO Cheie de bujii
- F Douille à bougies
- I Chiavi a bussola
- E Boquilla de bujías
- CN 六角火花塞套筒

3/8" 10mm  
DIN 3124  
AS-DRIVE CrV 6140

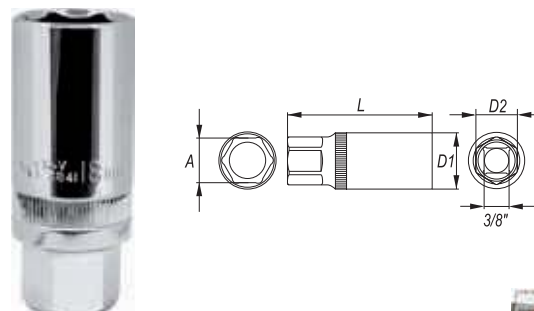

COLOR BOX

YATO	Ø	A	D1 (mm)	D2 (mm)	L (mm)	PCS packing	
YT-3841	3/8" (9.5 mm)	18.0	25.8	19.0	63	25	50/100



GB Quick release ratchet handle  
 D Hebelumschaltknarre  
 PL Grzechotka  
 RUS Трещотка  
 CZ Řehtačka  
 H Racsnis hajtókar

RO Dispozitiv de prindere cu clichet  
 F Clé à cliquet  
 I Cricchetto bussola  
 E Carraca  
 CN 快速脱落棘轮扳手

PLASTIC HANGER



6 PCS



COLOR BOX

3/8"  
10mm

DIN  
3122

QUICK  
RELEASE  
SZYBKO-  
ZŁĄCZE

72T

CrV  
6140



YATO	Ø	T	L (mm)	PCS packing	Box
YT-0308	3/8" (9.5 mm)	72	185	6	24/48

YATO	Ø	T	L (mm)	PCS packing	Box
YT-0311	3/8" (9.5 mm)	72	200	6	18/36

YATO	Ø	T	L (mm)	PCS packing	Box
YT-0314	3/8" (9.5 mm)	72	170	6	24/48



YATO	Ø	T	L (mm)	PCS packing	Box
YT-0317	3/8" (9.5 mm)	72	200	6	24/48

YATO	Ø	T	L (mm)	PCS packing	Box
YT-0320	3/8" (9.5 mm)	72	205	6	24/48

YATO	Ø	T	L (mm)	PCS packing	Box
YT-0323	3/8" (9.5 mm)	72	197	6	24/48

GB Quick release ratchet handle  
 D Hebelumschaltknarre  
 PL Grzechotka  
 RUS Трещотка  
 CZ Řehtačka  
 H Racsnis hajtókar

RO Dispozitiv de prindere cu clichet  
 F Clé à cliquet  
 I Cricchetto bussola  
 E Carraca  
 CN 快速脱落棘轮扳手

PLASTIC HANGER



6 PCS



COLOR BOX

3/8"  
10mm

QUICK  
RELEASE  
SZYBKO-  
ZŁĄCZE

DIN  
3122

72T

CrV  
6140

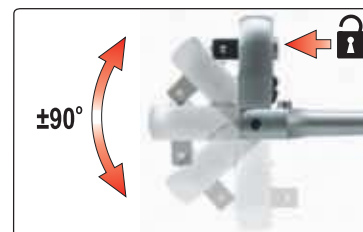

YATO	Ø	T	L (mm)	PCS packing	Box
YT-0326	3/8" (9.5 mm)	72	242	6	24/48

GB Quick release ratchet handle  
 D Hebelumschaltknarre  
 PL Grzechotka powlekana  
 RUS Трещотка  
 CZ Řehtačka  
 H Racsnis hajtókar

RO Dispozitiv de prindere cu clichet  
 F Clé à cliquet  
 I Cricchetto bussola  
 E Carraca  
 CN 快速脱落棘轮扳手

PLASTIC HANGER



6 PCS



COLOR BOX

3/8"  
10mm

DIN  
3122

QUICK  
RELEASE  
SZYBKO-  
ZŁĄCZE

72T

CrV  
6135



YATO	Ø	T	L (mm)	PCS packing	Box
YT-0291	3/8" (9.5 mm)	72	202	6	24/48

YATO	Ø	T	L (mm)	PCS packing	Box
YT-0294	3/8" (9.5 mm)	72	202	6	24/48

- GB Quick release ratchet handle
- D Hebelumschaltknarre
- PL Grzechotka
- RUS Трещотка
- CZ Řehtačka
- H Racsnis hajtókar
- RO Dispozitiv de prindere cu clichet
- F Clé à cliquet
- I Cricchetto bussola
- E Carraca
- CN 快速脱落棘轮扳手



6 PCS



**3/8"**  
**10mm**  
**72T**  
**CrV 6140**

- GB Quick release ratchet handle
- D Hebelumschaltknarre
- PL Grzechotka
- RUS Трещотка
- CZ Řehtačka
- H Racsnis hajtókar
- RO Dispozitiv de prindere cu clichet
- F Clé à cliquet
- I Cricchetto bussola
- E Carraca
- CN 快速脱落棘轮扳手



6 PCS



**3/8"**  
**10mm**  
**72T**  
**CrV 6135**



YATO	Ø	T	L (mm)	PCS packing:	Box
YT-0731	3/8" (9.5 mm)	72	200	6	24/48

YATO	Ø	T	L (mm)	PCS packing:	Box
YT-0734	3/8" (9.5 mm)	72	200	6	24/48

- GB Telescopic ratchet handle
- D Umschaltknarre
- PL Grzechotka z przedłużanym uchwytem
- RUS Трещотка
- CZ Řehtačka
- H Racsnis hajtókar
- RO Antrenor cu clichet
- F Clé à cliquet
- I Cricchetto bussola
- E Carraca telescópico
- CN 可伸缩快速脱落棘轮扳手



**3/8"**  
**10mm**  
**72T**  
**CrV 6135**



PLASTIC HANGER



6 PCS



YATO	Ø	T	L (mm)	PCS packing:	Box
YT-0298	3/8" (9.5 mm)	72	215-315	6	24

GB Hexagonal socket  
D Sechskantenschlüssel  
PL Nasadka sześciokątna  
RUS Головка шестигранная короткая  
CZ Šestihranný nástavec  
H Hatszögű rátét  
RO Cheie tubulară hexagonală  
F Douille courte  
I Chiave a bussola esagonale  
E Boquilla hexagonal corta  
CN 六角套筒

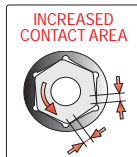

1/2" 12.5mm  
DIN 3121  
CrV 50BV30  
AS-DRIVE

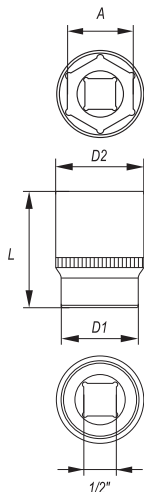

- drive locks
- surface finish: chromed, satin / mirror
- zamki blokujące
- wykończenie powierzchni: chromowana, satynowa / polerowana

COLOR BOX



YATO	∅ A (mm)	D1 (mm)	D2 (mm)	L (mm)	PCS packing	
YT-1201	8	12	22	38	10	100/200
YT-1202	9	14	22	38	10	100/200
YT-1203	10	15	22	38	10	100/200
YT-1204	11	16	22	38	10	100/200
YT-1205	12	18	22	38	10	100/200
YT-1206	13	19	22	38	10	100/200
YT-1207	14	20	22	38	10	100/200
YT-1208	15	21	22	38	10	100/200
YT-1209	16	23	22	38	10	100/200
YT-1210	17	24	23	38	10	100/200
YT-1211	18	25	23	38	10	100/200
YT-1212	19	27	24	38	10	100/200
YT-1213	20	28	24	38	10	100/200
YT-1214	21	29	24	38	10	100/200
YT-1215	22	30	26	38	10	100/200
YT-1216	23	31	28	38	10	50/100
YT-1217	24	32	28	38	10	50/100
YT-1218	27	36	30	42	10	50/100
YT-1219	30	40	34	42	10	50/100
YT-1220	32	42	36	42	10	50/100

GB Bi-hexagonal socket  
D Zwölfkant-Steckschlüssel-Einsatz  
PL Nasadka dwunastokątna  
RUS Головка 12-гранная  
CZ Nástrčný ořech dvanáctihřanný  
H Dugófej, 12 lapú  
RO Cheie tubulară bihexagonală  
F Douille courte  
I Chiave a bussola esagonale  
E Boquilla de anillo  
CN 十二角套筒

1/2" 12.5mm  
DIN 3121  
CrV 50BV30  
AS-DRIVE

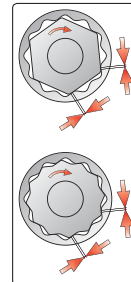
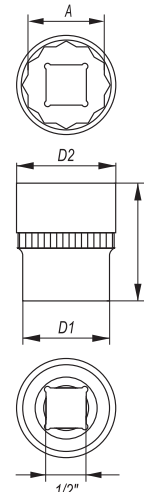

- drive locks
- surface finish: chromed, satin / mirror
- zamki blokujące
- wykończenie powierzchni: chromowana, satynowa / polerowana

COLOR BOX



YATO	∅ A (mm)	D1 (mm)	D2 (mm)	L (mm)	PCS packing	
YT-1270	8	12	22	38	10	100/200
YT-1271	9	14	22	38	10	100/200
YT-1272	10	15	22	38	10	100/200
YT-1273	11	16	22	38	10	100/200
YT-1274	12	17	22	38	10	100/200
YT-1275	13	19	22	38	10	100/200
YT-1276	14	20	22	38	10	100/200
YT-1277	15	21	22	38	10	100/200
YT-1278	16	23	22	38	10	100/200
YT-1279	17	24	22	38	10	100/200
YT-1280	18	25	23	38	10	100/200
YT-1281	19	27	24	38	10	100/200
YT-1282	20	28	24	38	10	100/200
YT-1283	21	29	24	38	10	100/200
YT-1284	22	30	26	38	10	100/200
YT-1285	23	31	28	38	10	50/100
YT-1286	24	32	28	38	10	50/100
YT-1289	27	36	30	42	10	50/100
YT-1291	30	40	34	42	10	50/100
YT-1292	32	42	36	42	10	50/100

GB Spline socket  
D Steckschlüssel Spline  
PL Nasadka Spline  
RUS Головка Spline  
CZ Nástrčný klíč profil Spline  
H Spline dugófej

RO Cheie tubulară cu stifturi  
F Douille  
I Chiave a bussola spline  
E Boquilla Spline  
CN 花键型套筒

1/2" 12.5mm  
DIN 3121  
CrV 50BV30

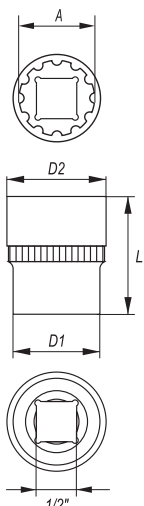
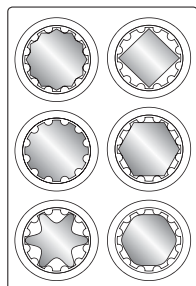

- drive locks
- enables to undo 5 types of screws
- allows to unscrew nuts damaged in 70%
- surface finish: chromed, satin / mirror
- zamki blokujące
- możliwość odkręcenia 5 rodzajów śrub
- możliwość odkręcenia nasadek zniszczonych w 70%
- wykończenie powierzchni: chromowana, satynowa / polerowana

COLOR BOX



YATO	∅ A (mm)	D1 (mm)	D2 (mm)	L (mm)	PCS packing	
YT-1460	8	13	22	38	10	100/200
YT-1461	9	15	22	38	10	100/200
YT-1462	10	16	22	38	10	100/200
YT-1463	11	17	22	38	10	100/200
YT-1464	12	18	22	38	10	100/200
YT-1465	13	19	22	38	10	100/200
YT-1466	14	20	22	38	10	100/200
YT-1467	15	22	23	38	10	100/200
YT-1468	16	23	22	38	10	100/200
YT-1469	17	25	23	38	10	100/200
YT-1470	18	26	23	38	10	100/200
YT-1471	19	27	24	38	10	100/200
YT-1472	20	28	24	38	10	100/200
YT-1473	21	30	24	38	10	100/200
YT-1474	22	31	26	38	10	100/200
YT-1475	23	32	28	38	10	50/100
YT-1476	24	34	28	38	10	50/100
YT-1478	27	37	30	42	10	50/100
YT-1480	30	41	34	42	10	50/100
YT-1481	32	44	36	45	10	50/100

- GB Hexagonal deep socket
- D Sechskantenschlüssel, lange
- PL Nasadka sześciokątna długa
- RUS Головка шестигранная длинная
- CZ Šestihranný hluboký nástavec
- H Hatszögű rátét mély
- RO Cheie tubulară hexagonală adâncă
- F Douille longue
- I Chiave a bussola esagonale
- E Boquilla hexagonal larga
- CN 六角长套筒

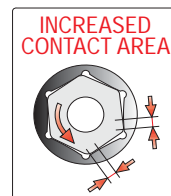
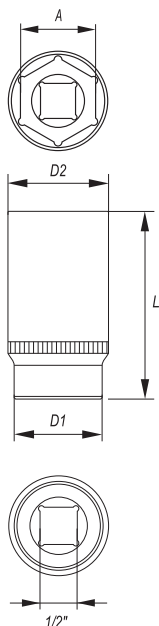

**1/2"**  
**12.5mm**

**DIN 3121**

**CrV**  
**50BV30**

**AS-DRIVE**

- drive locks
- surface finish: chromed, satin / mirror
- zamki blokujące
- wykończenie powierzchni: chromowana, satynowa / polerowana

COLOR BOX



YATO	∅ A (mm)	D1 (mm)	D2 (mm)	L (mm)	PCS packing:	
YT-1221	8	13	22	76	10	50/100
YT-1222	9	14	22	76	10	50/100
YT-1223	10	15	22	76	10	50/100
YT-1224	11	17	22	76	10	50/100
YT-1225	12	18	22	76	10	50/100
YT-1226	13	19	22	76	10	50/100
YT-1227	14	20	22	76	10	50/100
YT-1228	15	21	22	76	10	50/100
YT-1229	16	24	22	76	10	50/100
YT-1230	17	24	22	76	10	50/100
YT-1231	18	25	23	76	10	50/100
YT-1232	19	27	24	76	10	50/100
YT-1233	20	28	24	76	10	50/100
YT-1234	21	29	24	76	10	50/100
YT-1235	22	30	26	76	10	50/100
YT-1236	23	31	28	76	10	50/100
YT-1237	24	32	28	76	10	50/100
YT-1238	27	36	30	76	10	50
YT-1239	30	40	36	76	10	20/40
YT-1240	32	42	38	76	10	20/40

- GB Extension bar
- D Verlängerung
- PL Przedłużka
- RUS Удлинитель для воротка
- CZ Prodlužovací přípravek
- H Toldalék
- RO Prelungitor
- F Rallonge
- I Prolunga
- E Tubo de prolongación
- CN 接杆

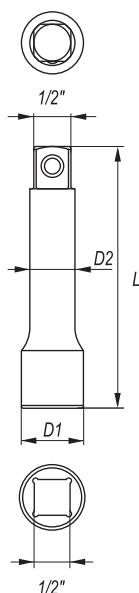

**1/2"**  
**12.5mm**

**DIN 3121**

**CrV**  
**50BV30**

COLOR BOX



YATO	∅	D1 (mm)	D2 (mm)	L (mm)	PCS packing:	
YT-1246	1/2" (12.7 mm)	24.0	14.5	76	15	30/120
YT-1247	1/2" (12.7 mm)	24.0	14.5	127	5	20/80
YT-1248	1/2" (12.7 mm)	24.0	14.5	254	5	20/40

- GB Extension bar with wobble
- D Gelenverlängerung
- PL Przedłużka uchylna
- RUS Удлинитель наклонный
- CZ Odchylný prodlužovací přípravek
- H Csuklós toldalék
- RO Prelungitor rabatabil
- F Rallonge angulaire
- I Prolunga
- E Tubo de prolongación desviable
- CN 转向接杆

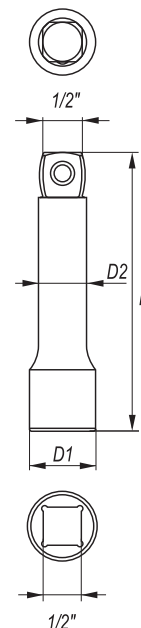

**1/2"**  
**12.5mm**

**DIN 3121**

**CrV**  
**50BV30**

COLOR BOX



YATO	∅	D1 (mm)	D2 (mm)	L (mm)	PCS packing:	
YT-1249	1/2" (12.7 mm)	24.0	14.5	76	15	30/120
YT-1250	1/2" (12.7 mm)	24.0	14.5	127	5	20/80
YT-1251	1/2" (12.7 mm)	24.0	14.5	254	5	20/40

- GB Adapter
- D Reduktion
- PL Redukcja
- RUS Переходник
- CZ Redukce
- H Redukció
- RO Reducție
- F Réduction
- I Riduttore
- E Reducción
- CN 转换头

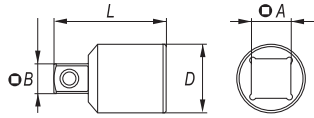

COLOR BOX



1/2"	3/4"	DIN	CrV
12.5mm	19mm	3121	50BV30

YATO	Ø A	Ø B	D (mm)	L (mm)	PCS packing:	
YT-1255	1/2" (12.7 mm) (F)	3/8" (9.5 mm) (M)	22	34.0	10	100/200
YT-1258	1/2" (12.7 mm) (F)	3/4" (19.0 mm) (M)	27	45.5	10	50/100
YT-1259	3/4" (19.0 mm) (F)	1/2" (12.7 mm) (M)	35	51.0	5	50/100
YT-1356	1/2" (12.7 mm) (F)	3/4" (19.0 mm) (M)	26	48.0	12	48

- GB Bit adapter
- D Bithalter
- PL Adapter do bitów
- RUS Держатель винтовёртовых наконечников
- CZ Držák na šroubovakové koncovky
- H Szár a csavarhúzóvégekhez
- RO Capete şurubelniță
- F Adapteur d'embouts
- I Chiave esagonale a bussola
- E Mandril para puntas
- CN 旋具头接头

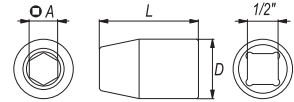

COLOR BOX



1/2"	CrV
12.5mm	6140

YATO	Ø	Ø A	D (mm)	L (mm)	PCS packing:	
YT-1295	1/2" (12.7 mm)	8 mm	21.9	38	10	250/500

- GB Universal joint
- D Kardangelenk
- PL Przegub Cardana
- RUS Карданный шарнир
- CZ Kardanový kloub
- H Kardán csukló

- RO Articulație Cardanică
- F Cardan
- I Snodo cardanico
- E Articulación Cardan
- CN 万向接头

1/2"	DIN	CrV
12.5mm	3121	50BV30

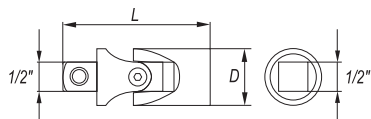

COLOR BOX



YATO	Ø	D (mm)	L (mm)	PCS packing:	
YT-1252	1/2" (12.7 mm)	25	69	5	50/100

- GB Sliding T-bar
- D Handgriff
- PL Pokrętko typu „T”
- RUS Вороток Т-образный

- CZ Otočná račka typ „T”
- H „T” alakú hajtókar
- RO Mâner clupă tipul „T”
- F Barre type „T”

- I Manopola „T” scorrevole
- E Mango tipo „T”
- CN 滑行杆

1/2"	DIN	CrV
12.5mm	3121	50BV30

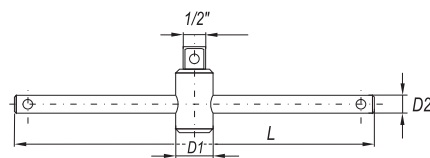

COLOR BOX



YATO	Ø	D1 (mm)	D2 (mm)	L (mm)	PCS packing:	
YT-1243	1/2" (12.7 mm)	24.0	13.5	255	4	24/48

- GB Flexible handle
- D Gelenkgriff
- PL Pokrętko łamane
- RUS Вороток шарнирный
- CZ Otočná lomená ráčka
- H Hajlított hajtókar
- RO Prelungitor cu prindere flexibilă
- F Barre pivotante
- I Manopola a snodo
- E Mango articulado
- CN 转向手柄

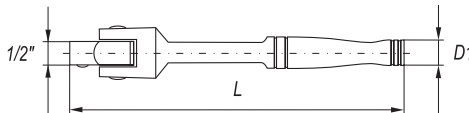

1/2"	DIN	CrV
12.5mm	3121	50BV30

COLOR BOX



YATO	Ø	D (mm)	L (mm)	PCS packing:	
YT-1241	1/2" (12.7 mm)	19	360	5	15/30
YT-1242	1/2" (12.7 mm)	20	457	5	10/20

- GB L-type handle
- D Admutter Schlüssel
- PL Pokrętko typu „L”
- RUS Вороток 1/2" тип „L”
- CZ Páka zahnutá
- H „L” alakú hajtókar
- RO Mâner clupă tipul „L”
- F Barre type „L”
- I Leva tipo „L”
- E Mango tipo „L”
- CN L型套筒扳手



1/2"	DIN	CrV
12.5mm	3121	50BV30

COLOR BOX



YATO	Ø	D (mm)	L (mm)	PCS packing:	
YT-1244	1/2" (12.7 mm)	16.5	317	3	36

- GB Spark plug socket
- D Steckschlüssel mit Gummihalterung
- PL Nasadka do świec
- RUS Головка свечная
- CZ Nastavec pro svíčky
- H Gyújtógyertya toldalék
- RO Cheie de bujii
- F Douille à bougies
- I Chiavi a bussola
- E Boquilla de bujías
- CN 六角火花塞套筒

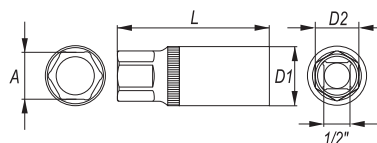

1/2"	DIN	CrV	AS-DRIVE
12.5mm	3121	50BV30	

COLOR BOX



YATO	Ø	A	D1 (mm)	D2 (mm)	L (mm)	PCS packing:	
YT-1253	1/2" (12.7 mm)	16.0	22.0	19.0	64.0	10	50/100
YT-1254	1/2" (12.7 mm)	21.0	27.8	24.0	64.0	10	50/100

GB Quick release ratchet handle  
 D Hebelumschaltknarre  
 PL Grzechotka  
 RUS Трещотка  
 CZ Řehotačka  
 H Racsnis hajtókar

RO Dispozitiv de prindere cu clichet  
 F Clé à cliquet  
 I Cricchetto bussola  
 E Carraca  
 CN 快速脱落棘轮扳手

PLASTIC HANGER



6 PCS



COLOR BOX

1/2"  
12.5mm

DIN  
3122

QUICK  
RELEASE  
SZYBKO-  
ZŁĄCZE

72T

CrV  
6140



YATO	Ø	T	L (mm)	PCS packing:	☐
YT-0309	1/2" (12.7 mm)	72	278	6	24

YATO	Ø	T	L (mm)	PCS packing:	☐
YT-0312	1/2" (12.7 mm)	72	250	6	12/24

YATO	Ø	T	L (mm)	PCS packing:	☐
YT-0315	1/2" (12.7 mm)	72	250	6	24



YATO	Ø	T	L (mm)	PCS packing:	☐
YT-0318	1/2" (12.7 mm)	72	250	6	24

YATO	Ø	T	L (mm)	PCS packing:	☐
YT-0321	1/2" (12.7 mm)	72	255	6	24

YATO	Ø	T	L (mm)	PCS packing:	☐
YT-0324	1/2" (12.7 mm)	72	265	6	24

GB Quick release ratchet handle  
 D Hebelumschaltknarre  
 PL Grzechotka  
 RUS Трещотка  
 CZ Řehotačka  
 H Racsnis hajtókar

RO Dispozitiv de prindere cu clichet  
 F Clé à cliquet  
 I Cricchetto bussola  
 E Carraca  
 CN 快速脱落棘轮扳手

PLASTIC HANGER



6 PCS



COLOR BOX

1/2"  
12.5mm

QUICK  
RELEASE  
SZYBKO-  
ZŁĄCZE

DIN  
3122

72T

CrV  
6140

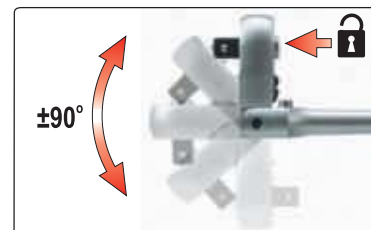

YATO	Ø	T	L (mm)	PCS packing:	☐
YT-0327	1/2" (12.7 mm)	72	290	6	24

GB Quick release ratchet handle  
 D Hebelumschaltknarre  
 PL Grzechotka powlekana  
 RUS Трещотка  
 CZ Řehotačka  
 H Racsnis hajtókar

RO Dispozitiv de prindere cu clichet  
 F Clé à cliquet  
 I Cricchetto bussola  
 E Carraca  
 CN 快速脱落棘轮扳手

PLASTIC HANGER



6 PCS



COLOR BOX

1/2"  
12.5mm

QUICK  
RELEASE  
SZYBKO-  
ZŁĄCZE

DIN  
3122

72T

CrV  
6135



YATO	Ø	T	L (mm)	PCS packing:	☐
YT-0292	1/2" (12.7 mm)	72	257	6	24

YATO	Ø	T	L (mm)	PCS packing:	☐
YT-0295	1/2" (12.7 mm)	72	257	6	24

GB Quick release ratchet handle  
 D Hebelumschaltknarre  
 PL Grzechotka  
 RUS Трещотка  
 CZ Řehtačka  
 H Racsnis hajtókar  
 RO Dispozitiv de prindere cu clichet  
 F Clé à cliquet  
 I Cricchetto bussola  
 E Carraca  
 CN 快速脱落棘轮扳手

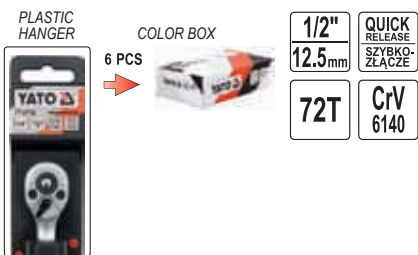

1/2"  
 12.5mm  
 72T  
 CrV  
 6140



GB Quick release ratchet handle  
 D Hebelumschaltknarre  
 PL Grzechotka  
 RUS Трещотка  
 CZ Řehtačka  
 H Racsnis hajtókar  
 RO Dispozitiv de prindere cu clichet  
 F Clé à cliquet  
 I Cricchetto bussola  
 E Carraca  
 CN 快速脱落棘轮扳手

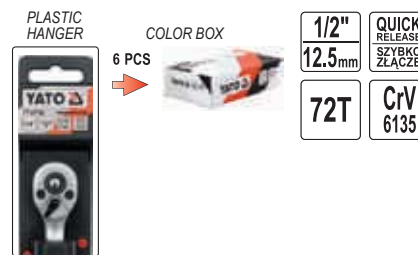

1/2"  
 12.5mm  
 72T  
 CrV  
 6135



YATO	Ø	T	L (mm)	PCS packing:	
YT-0732	1/2" (12.7 mm)	72	255	6	24

YATO	Ø	T	L (mm)	PCS packing:	
YT-0735	1/2" (12.7 mm)	72	255	6	24

GB Telescopic ratchet handle  
 D Umschaltknarre  
 PL Grzechotka z przedłużanym uchwytem  
 RUS Трещотка  
 CZ Řehtačka  
 H Racsnis hajtókar  
 RO Antrenor cu clichet  
 F Clé à cliquet  
 I Cricchetto bussola  
 E Carraca telescópico  
 CN 可伸缩快速脱落棘轮扳手



1/2"  
 12.5mm  
 72T  
 CrV  
 6135



YATO	Ø	T	L (mm)	PCS packing:	
YT-0299	1/2" (12.7 mm)	72	305-445	6	24

GB Flexible ratchet handle / round head  
 D Flexible Drehkopfratsche  
 PL Grzechotka z obrotową głowicą  
 RUS Трещотка с вращательной головкой  
 CZ Ráčna s otočnou hlavou  
 H Forgófejés racsnis szár  
 RO Antrenor cu clichet flexibil  
 F Clé à cliquet tête pivotante  
 I Cricchetto bussola reversibile con ghiera  
 E Carraca con cabeza giratoria  
 CN 旋转头快速脱落棘轮扳手



1/2"  
 12.5mm  
 72T  
 CrV  
 6140



YATO	Ø	T	L (mm)	PCS packing:	
YT-0722	1/2" (12.7 mm)	72	280	6	30

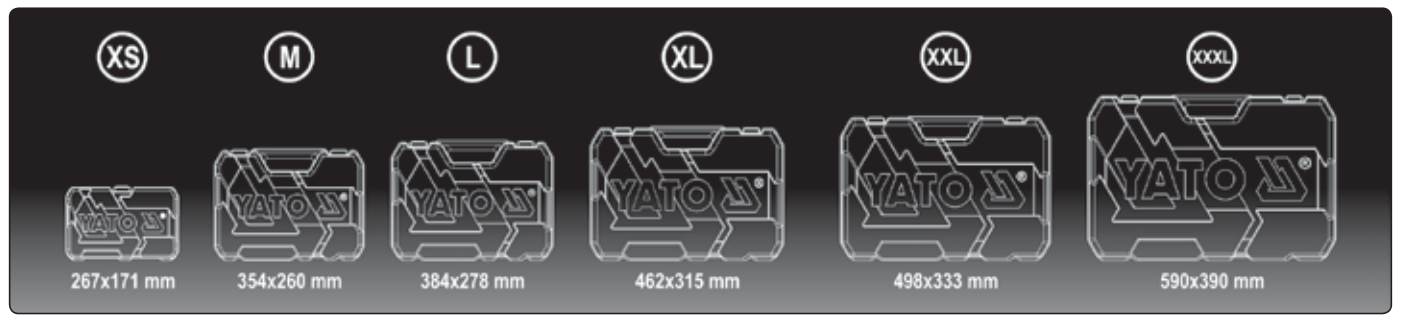

GB Tool set  
 D Sechskant-Steckschlüssel-Satz  
 PL Zestaw narzędziowy  
 RUS Набор инструмента  
 CZ Sada nástrčných kľúčů a ráčny  
 H Dugókulcs készlet racsnis hajtókarral

RO Rotrusa chei tubulare cu antrenor  
 F Coffret d'outillage  
 I Set di utensili  
 E Juego de herramientas  
 CN 套筒扳手组套

BMC & COLOR SLEEVE  
 XS SIZE



1/4" 6.3mm	CrV 50BV30	CrMo 440
72T	AS-DRIVE	



23  
PCS

- 1/4" (6.3 mm): 4, 5, 6, 7, 8, 9, 10, 12, 13 mm (L=25 mm); CrV 50BV30;
- 1/4" (6.3 mm): 4, 5, 6, 7, 8, 9, 10, 12, 13 mm (L=50 mm); CrV 50BV30;
- 1/4" (6.3 mm): (50.8, 152.4 mm); CrV 50BV30;
- 1/4" (6.3 mm); CrV 50BV30;
- 1/4" (6.3 mm): (155 mm); 72T; CrMo 440;
- 1/4" (6.3 mm): (150 mm); CrV 50BV30

<b>YATO</b>		
YT-14451	1/4" (6.3 mm)	10



25  
PCS

CrV  
40

- 1/4" (6.3 mm): 3.5, 4, 4.5, 5, 5.5, 6, 7, 8, 9, 10, 11, 12, 13, 14 mm (L=25 mm); CrV 50BV30;
- 1/4" (6.3 mm): 8, 10, 11, 12, 13 mm (L=50 mm); CrV 50BV30;
- 1/4" (6.3 mm): (50.8, 101.6 mm); CrV 50BV30;
- 1/4" (6.3 mm); CrV 50BV30;
- 1/4" (6.3 mm): (152.4 mm); CrV 40;
- 1/4" (6.3 mm): (155 mm); 72T; CrMo 440;
- 1/4" (6.3 mm): (150 mm); CrV 50BV30

<b>YATO</b>		
YT-14461	1/4" (6.3 mm)	10



38  
PCS

CrV  
6150

CrV  
40

S2

- 1/4" (6.3 mm): 3.5, 4, 4.5, 5, 5.5, 6, 7, 8, 9, 10, 11, 12, 13, 14 mm (L=25 mm); CrV 50BV30;
- 1/4" (6.3 mm): (50.8, 101.6 mm); CrV 50BV30;
- 1/4" (6.3 mm); CrV 50BV30;
- 1/4" (6.3 mm): (152.4 mm); CrV 40;
- 1/4" (6.3 mm): (155 mm); 72T; CrMo 440;
- 1/4" (6.3 mm): (150 mm); CrV 50BV30;
- 1/4" (6.3 mm): 4, 5.5, 6.5 mm (L=37 mm); AISI S2 / CrV 6150;
- 1/4" (6.3 mm): PH1, PH2 (L=37 mm); AISI S2 / CrV 6150;
- 1/4" (6.3 mm): PZ1, PZ2 (L=37 mm); AISI S2 / CrV 6150;
- 1/4" (6.3 mm): T10, T15, T20, T25, T30, T40 (L=37 mm); AISI S2 / CrV 6150;
- 1/4" (6.3 mm): 3, 4, 5, 6, 8 mm (L=37 mm); AISI S2 / CrV 6150

<b>YATO</b>		
YT-14471	1/4" (6.3 mm)	10



GB Tool set  
D Sechskant-Steckschlüssel-Satz  
PL Zestaw narzędziowy  
RUS Набор инструмента

CZ Sada nástrčných klíčů a ráčny  
H Dugókulcs készlet racsnis hajtókarral  
RO Rotrusa chei tubulare cu antrenor  
F Coffret d'outillage

I Set di utensili  
E Juego de herramientas  
CN 套筒扳手组套

BMC & COLOR SLEEVE  
XS SIZE



42  
PCS

1/4" 6.3mm	CrV 50BV30	CrV 6150
CrV 40	CrMo 440	S2
72T	AS-DRIVE	



- 1/4" (6.3 mm): 4, 4.5, 5, 5.5, 6, 7, 8, 9, 10, 11, 12, 13, 14 mm (L=25 mm); CrV 50BV30;
- 1/4" (6.3 mm): 8, 9, 10, 11, 12, 13 mm (L=50 mm); CrV 50BV30;
- 1/4" (6.3 mm): (50.8, 101.6 mm); CrV 50BV30;
- 1/4" (6.3 mm); (150 mm); CrV 50BV30;
- 1/4" (6.3 mm); CrV 50BV30;
- 1/4" (6.3 mm); (152.4 mm); CrV 40;
- 1/4" (6.3 mm); (155 mm); 72T; CrMo 440;
- 1/4" (6.3 mm); (150 mm); CrV 50BV30;
- 1/4" (6.3 mm) x 1/4" (6.3 mm); CrV 50BV30;
- 1/4" (6.3 mm): 3, 4, 5 mm (L=25 mm); AISI S2;
- 1/4" (6.3 mm): PH0, PH1, PH2 (L=25 mm); AISI S2;
- 1/4" (6.3 mm): PZ0, PZ1, PZ2 (L=25 mm); AISI S2;
- 1/4" (6.3 mm): 6, 7, 8 mm (L=25 mm); AISI S2;
- 1.5, 2.0, 2.5 mm; CrV 6150

<b>YATO</b>	○	
YT-14481	1/4" (6.3 mm)	6



56  
PCS

- 1/4" (6.3 mm): 4, 4.5, 5, 5.5, 6, 7, 8, 9, 10, 11, 12, 13 mm (L=25 mm); CrV 50BV30;
- 1/4" (6.3 mm): 6, 7, 8, 9, 10, 11, 12, 13 mm (L=50 mm); CrV 50BV30;
- 1/4" (6.3 mm): E4, E5, E6, E7, E8, E10; CrV 6150;
- 1/4" (6.3 mm): (76, 152.4 mm); CrV 50BV30;
- 1/4" (6.3 mm); (150 mm); CrV 50BV30;
- 1/4" (6.3 mm); CrV 50BV30;
- 1/4" (6.3 mm); (152.4 mm); CrV 40;
- 1/4" (6.3 mm); (155 mm); 72T; CrMo 440;
- 1/4" (6.3 mm); (150 mm); CrV 50BV30;
- 1/4" (6.3 mm) (F) x 3/8" (9.5 mm) (M); CrV 50BV30;
- 1/4" (6.3 mm): 4, 5, 5.5, 6.5 mm (L=37 mm); AISI S2 / CrV 6150;
- 1/4" (6.3 mm): PH1, PH2, PH3 (L=37 mm); AISI S2 / CrV 6150;
- 1/4" (6.3 mm): PZ1, PZ2, PZ3 (L=37 mm); AISI S2 / CrV 6150;
- 1/4" (6.3 mm): T8, T10, T15, T20, T25, T30, T40 (L=37 mm); AISI S2 / CrV 6150;
- 1/4" (6.3 mm): 3, 4, 5, 6, 7, 8 mm (L=37 mm); AISI S2 / CrV 6150

<b>YATO</b>	○	
YT-14501	1/4" (6.3 mm)	10

GB Tool set  
D Sechskant-Steckschlüssel-Satz  
PL Zestaw narzędziowy  
RUS Набор инструмента

CZ Sada nástrčných klíčů a ráčny  
H Dugókulcs készlet racsnis hajtókarral  
RO Rotrusa chei tubulare cu antrenor  
F Coffret d'outillage

I Set di utensili  
E Juego de herramientas  
CN 套筒扳手组套

BMC & COLOR SLEEVE  
XS SIZE



22 PCS	3/8" 10mm	CrV 50BV30	CrV 40
CrMo 440	72T	AS-DRIVE	



- 3/8" (9.5 mm): 6, 7, 8, 9, 10, 11, 12, 13, 14, 15, 16 mm (L=28 mm); 17, 18, 19, 20, 21, 22 mm (L=30 mm); CrV 50BV30;
- 3/8" (9.5 mm): (76, 152.4 mm); CrV 50BV30;
- 3/8" (9.5 mm); CrV 50BV30;
- 3/8" (9.5 mm); (198 mm); CrV 40;
- 3/8" (9.5 mm); (200 mm); 72T; CrMo 440

<b>YATO</b>	○	
YT-38561	3/8" (9.5 mm)	10

GB Socket set  
D Sechskant-Steckschlüssel-Satz  
PL Komplet nasadek długich  
RUS Набор насадок

CZ Sada nástrčných klíčů  
H Dugókulcs készlet  
RO Trusă chei tubulare  
F Set de douilles longues

I Serie di chiavi a bussola lunghi  
E Juego de herramientas  
CN 长套筒组套

PLASTIC HANGER



10  
PCS

1/2"  
12.5mm

CrV  
50BV30

AS-DRIVE



1/2" (12.7 mm): 10, 12, 13, 14, 15, 17, 19, 21, 22, 24 mm (L=76 mm); CrV 50BV30

<b>YATO</b>	○	
YT-38861	1/2" (12.7 mm)	5/10

GB Socket set  
D Sechskantenschlüssel-Einsatz  
PL Komplet nasadek z akcesoriami  
RUS Набор торцевых головок

CZ Sada nástrčných klíčů a ráčny  
H Dugókulcs készlet racsnis hajtókarral  
RO Trusă chei tubulare cu antrenor  
F Set de douilles + accessoires

I Serie di chiavi a con accessori  
E Juego de boquillas con accesorios  
CN 套筒扳手组套

PLASTIC HANGER



12  
PCS

1/2"  
12.5mm

CrV  
50BV30

CrMo  
440

72T

AS-DRIVE



1/2" (12.7 mm): 10, 11, 12, 13, 14, 15, 17, 19, 21, 24 mm (L=38 mm); CrV 50BV30;  
1/2" (12.7 mm): (127 mm); CrV 50BV30;  
1/2" (12.7 mm): (255 mm); 72T; CrMo 440

<b>YATO</b>	○	
YT-38821	1/2" (12.7 mm)	5/10

GB Ratchet handle with socket set  
D Sechskant-Steckschlüssel-Satz  
PL Komplet nasadek z grzechotką  
RUS Набор насадок

CZ Sada nástrčných klíčů a ráčny  
H Dugókulcs készlet racsnis hajtókarral  
RO Rotrusă chei tubulare cu antrenor  
F Clé mixte à cliquet + douilles

I Serie di chiavi con cricchetto  
E Matraca con boquillas  
CN 套筒扳手组套

PLASTIC HANGER



19  
PCS

1/2"  
12.5mm

CrV  
50BV30

CrMo  
440

72T

AS-DRIVE



1/2" (12.7 mm): 8, 9, 10, 11, 12, 13, 14, 15, 16, 17, 19, 21, 22, 23, 24 mm (L=38 mm);  
27, 30, 32 mm (L=42 mm); CrV 50BV30;  
1/2" (12.7 mm): (255 mm); 72T; CrMo 440

<b>YATO</b>	○	
YT-38861	1/2" (12.7 mm)	3/6

GB Tool set  
D Sechskant-Steckschlüssel-Satz  
PL Zestaw narzędziowy  
RUS Набор инструмента

CZ Sada nástrčných klíčů a ráčny  
H Dugókulcs készlet racsnis hajtókarral  
RO Rotrușa chei tubulare cu antrenor  
F Coffret d'outillage

I Set di utensili  
E Juego de herramientas  
CN 套筒扳手组套

BMC & COLOR SLEEVE  
XS SIZE



12 PCS	1/2" 12.5mm	CrV 50BV30	CrMo 440
		72T	AS-DRIVE



1/2" (12.7 mm): 10, 11, 12, 13, 14, 15, 17, 19, 21, 24 mm  
(L=38 mm); CrV 50BV30;  
1/2" (12.7 mm): (127 mm); CrV 50BV30;  
1/2" (12.7 mm): (255 mm); 72T; CrMo 440

<b>YATO</b>		
YT-38671	1/2" (12.7 mm)	10

GB Tool set  
D Sechskant-Steckschlüssel-Satz  
PL Zestaw narzędziowy  
RUS Набор инструмента

CZ Sada nástrčných klíčů a ráčny  
H Dugókulcs készlet racsnis hajtókarral  
RO Rotrușa chei tubulare cu antrenor  
F Coffret d'outillage

I Set di utensili  
E Juego de herramientas  
CN 套筒扳手组套

BMC & COLOR SLEEVE  
L SIZE



77 PCS	1/2" 12.5mm	1/4" 6.3mm
	CrV 50BV30	CrV 6150
	CrMo 440	S2
	72T	AS-DRIVE



1/2" (12.7 mm): 10, 11, 12, 13, 14, 15, 17, 19, 22, 24 mm (L=38 mm);  
27, 30, 32 mm (L=42 mm),  
1/4" (6.3 mm): 4, 5, 6, 7, 8, 9, 10, 11, 12 mm (L=25 mm); CrV 50BV30;  
1/2" (12.7 mm): (127, 254 mm),  
1/4" (6.3 mm): (76, 101.6 mm); CrV 50BV30;  
1/2" (12.7 mm), 1/4" (6.3 mm): CrV 50BV30;  
1/2" (12.7 mm): 16, 21 mm; CrV 50BV30;  
1/2" (12.7 mm): (255 mm),  
1/4" (6.3 mm): (155 mm); 72T; CrMo 440;  
1/4" (6.3 mm) x 1/4" (6.3 mm): CrV 50BV30;  
1/4" (6.3 mm) x 1/4" (6.3 mm): CrV 50BV30;  
1/4" (6.3 mm): 3, 4, 5.5, 7 mm (L=25 mm); AISI S2;  
1/4" (6.3 mm): PH0, PH1, PH2, PH3 (L=25 mm); AISI S2;  
1/4" (6.3 mm): PZ1, PZ2, PZ3 (L=25 mm); AISI S2;  
1/4" (6.3 mm): T10, T15, T20, T25, T30 (L=25 mm); AISI S2;  
1/4" (6.3 mm): 2, 3, 4, 5, 6 mm (L=25 mm); AISI S2;  
7, 8, 9, 10, 11, 12, 13, 14, 15, 17, 19 mm; CrV;  
8x9, 10x11, 12x13, 14x15 mm; CrV 50BV30;  
1.5, 2, 2.5, 5, 6, 8, 10 mm; CrV 6150

<b>YATO</b>		
YT-38781	1/2" (12.7 mm)	1/4" (6.3 mm)
		2

GB Tool set  
 D Sechskant-Steckschlüssel-Satz  
 PL Zestaw narzędziowy  
 RUS Набор инструмента

CZ Sada nástrčných klíčů a ráčny  
 H Dugókulcs készlet racsnis hajtókarral  
 RO Rotrușă chei tubulare cu antrenor  
 F Coffret d'outillage

I Set di utensili  
 E Juego de herramientas  
 CN 套筒扳手套

BMC & COLOR SLEEVE  
 L SIZE



1/2"	1/4"
12.5mm	6.3mm
CrV 50BV30	CrV 6150
CrV 40	CrMo 440
S2	72T
AS-DRIVE	

2



**82**  
 PCS

1/2" (12.7 mm): 14, 15, 16, 17, 18, 19, 20, 22, 24 mm (L=38 mm); 27, 30, 32 mm (L=42 mm); 1/4" (6.3 mm): 4, 4.5, 5, 5.5, 6, 7, 8, 9, 10, 11, 12, 13, 14 mm (L=25 mm); CrV 50BV30: 1/2" (12.7 mm): (127, 254 mm); 1/4" (6.3 mm): (50.8, 101.6 mm); CrV 50BV30: 3/8" (9.5 mm) (F) x 1/2" (12.7 mm) (M); CrV 50BV30: 1/4" (6.3 mm); (150 mm); CrV 50BV30: 1/2" (12.7 mm); 1/4" (6.3 mm); CrV 50BV30: 1/2" (12.7 mm): 16, 21 mm; CrV 50BV30: 1/4" (6.3 mm); (152.4 mm); CrV 40: 1/2" (12.7 mm); (255 mm); 1/4" (6.3 mm); (155 mm); 72T; CrMo 440: 1/4" (6.3 mm); (150 mm); CrV 50BV30: 1/2" (12.7 mm) x 5/16" (7.9 mm); CrV 50BV30: 1/4" (6.3 mm) x 1/4" (6.3 mm); CrV 50BV30: 5/16" (7.9 mm): 8, 10, 12 mm (L=30 mm); AISI S2: 5/16" (7.9 mm); PH3, PH4 (L=30 mm); AISI S2: 5/16" (7.9 mm); PZ3, PZ4 (L=30 mm); AISI S2: 5/16" (7.9 mm); T40, T45, T50, T55 (L=30 mm); AISI S2: 5/16" (7.9 mm): 8, 10, 12, 14 mm (L=30 mm); AISI S2: 1/4" (6.3 mm): 4, 5, 5, 7 mm (L=37 mm); AISI S2 / CrV 6150: 1/4" (6.3 mm); PH1, PH2 (L=37 mm); AISI S2 / CrV 6150: 1/4" (6.3 mm); PZ1, PZ2 (L=37 mm); AISI S2 / CrV 6150: 1/4" (6.3 mm); T8, T10, T15, T20, T25, T30 (L=37 mm); AISI S2 / CrV 6150: 1/4" (6.3 mm): 3, 4, 5, 6 mm (L=37 mm); AISI S2 / CrV 6150: 8, 10, 11, 12, 13, 14, 17, 19, 22 mm; CrV

YATO	1/2" (12.7 mm)	1/4" (6.3 mm)	4
YT-12691	1/2" (12.7 mm)	1/4" (6.3 mm)	4

**94**  
 PCS

1/2" (12.7 mm): 10, 11, 12, 13, 14, 15, 16, 17, 18, 19, 20, 21, 22, 23, 24 mm (L=38 mm); 27, 30, 32 mm (L=42 mm); 1/4" (6.3 mm): 4, 4.5, 5, 5.5, 6, 7, 8, 9, 10, 11, 12, 13, 14 mm (L=25 mm); CrV 50BV30: 1/2" (12.7 mm): 14, 15, 17, 19 mm (L=76 mm); 1/4" (6.3 mm): 6, 7, 8, 9, 10, 11, 12, 13 mm (L=50 mm); CrV 50BV30: 1/2" (12.7 mm): (127, 254 mm); 1/4" (6.3 mm): (50.8, 101.6 mm); CrV 50BV30: 3/8" (9.5 mm) (F) x 1/2" (12.7 mm) (M); CrV 50BV30: 1/4" (6.3 mm); (150 mm); CrV 50BV30: 1/2" (12.7 mm); 1/4" (6.3 mm); CrV 50BV30: 1/2" (12.7 mm): 16, 21 mm; CrV 50BV30: 1/4" (6.3 mm); (152.4 mm); CrV 40: 1/2" (12.7 mm); (255 mm); 1/4" (6.3 mm); (155 mm); 72T; CrMo 440: 1/4" (6.3 mm); (150 mm); CrV 50BV30: 1/2" (12.7 mm) x 5/16" (7.9 mm); CrV 50BV30: 1/4" (6.3 mm) x 1/4" (6.3 mm); CrV 50BV30: 5/16" (7.9 mm): 8, 10, 12 mm (L=30 mm); AISI S2: 5/16" (7.9 mm); PH3, PH4 (L=30 mm); AISI S2: 5/16" (7.9 mm); PZ3, PZ4 (L=30 mm); AISI S2: 5/16" (7.9 mm); T40, T45, T50, T55 (L=30 mm); AISI S2: 5/16" (7.9 mm): 8, 10, 12, 14 mm (L=30 mm); AISI S2: 1/4" (6.3 mm): 4, 5, 5, 7 mm (L=37 mm); AISI S2 / CrV 6150: 1/4" (6.3 mm); PH1, PH2 (L=37 mm); AISI S2 / CrV 6150: 1/4" (6.3 mm); PZ1, PZ2 (L=37 mm); AISI S2 / CrV 6150: 1/4" (6.3 mm); T8, T10, T15, T20, T25, T30 (L=37 mm); AISI S2 / CrV 6150: 1/4" (6.3 mm): 3, 4, 5, 6 mm (L=37 mm); AISI S2 / CrV 6150: 1.5, 2, 2.5 mm; CrV 6150

YATO	1/2" (12.7 mm)	1/4" (6.3 mm)	4
YT-12681	1/2" (12.7 mm)	1/4" (6.3 mm)	4

GB Tool set  
D Sechskant-Steckschlüssel-Satz  
PL Zestaw narzędziowy  
RUS Набор инструмента

CZ Sada nástrčných klíčů a ráčny  
H Dugókulcs készlet racsni hajtókarral  
RO Roturusa chei tubulare cu antrenor  
F Coffret d'outillage

I Set di utensili  
E Juego de herramientas  
CN 套筒扳手组套

1/2" 12.5mm	1/4" 6.3mm
CrV 50BV30	CrV 6150
CrMo 440	S2
72T	AS-DRIVE

2



BMC & COLOR SLEEVE  
L SIZE



108  
PCS

CrV  
40

1/2" (12.7 mm): 10, 11, 12, 13, 14, 15, 16, 17, 18, 19, 20, 21, 22, 24 mm (L=38 mm); 27, 30, 32 mm (L=42 mm), 1/4" (6.3 mm): 4, 4.5, 5, 5.5, 6, 7, 8, 9, 10, 11, 12, 13, 14 mm (L=25 mm); CrV 50BV30: 1/2" (12.7 mm): 14, 15, 17, 19, 22 mm (L=76 mm), 1/4" (6.3 mm): 6, 7, 8, 9, 10, 11, 12, 13 mm (L=50 mm); CrV 50BV30: 1/2" (12.7 mm): E10, E11, E12, E14, E16, E18, E20, E24, 1/4" (6.3 mm): E4, E5, E6, E7, E8; CrV 6150: 1/2" (12.7 mm): (127, 254 mm), 1/4" (6.3 mm): (50.8, 101.6 mm); CrV 50BV30: 3/8" (9.5 mm) (F) x 1/2" (12.7 mm) (M); CrV 50BV30: 1/2" (12.7 mm), 1/4" (6.3 mm); CrV 50BV30: 1/2" (12.7 mm): 16, 21 mm; CrV 50BV30: 1/4" (6.3 mm); (152.4 mm); CrV 40: 1/2" (12.7 mm); (255 mm), 1/4" (6.3 mm); (155 mm); 72T; CrMo 440: 1/4" (6.3 mm); (150 mm); CrV 50BV30: 1/2" (12.7 mm) x 5/16" (7.9 mm); CrV 50BV30: 5/16" (7.9 mm): 8, 10, 12 mm (L=30 mm); AISI S2: 5/16" (7.9 mm): PH3, PH4 (L=30 mm); AISI S2: 5/16" (7.9 mm): PZ3, PZ4 (L=30 mm); AISI S2: 5/16" (7.9 mm): T40, T45, T50, T55, T60 (L=30 mm); AISI S2: 5/16" (7.9 mm): 7, 8, 10, 12, 14 mm (L=30 mm); AISI S2: 1/4" (6.3 mm): 4, 5, 5, 6, 5 mm (L=37 mm); AISI S2 / CrV 6150: 1/4" (6.3 mm): PH1, PH2 (L=37 mm); AISI S2 / CrV 6150: 1/4" (6.3 mm): PZ1, PZ2 (L=37 mm); AISI S2 / CrV 6150: 1/4" (6.3 mm): T8, T10, T15, T20, T25, T27, T30 (L=37 mm); AISI S2 / CrV 6150: 1/4" (6.3 mm): 3, 4, 5, 6 mm (L=37 mm); AISI S2 / CrV 6150: 1.5, 2, 2.5 mm; CrV 6150

YATO	1/2" (12.7 mm)	1/4" (6.3 mm)	2
YT-38791			



BMC & COLOR SLEEVE  
XXL SIZE



109  
PCS

CrV  
6140

1/2" (12.7 mm): 12, 13, 14, 15, 16, 17, 18, 19, 20, 21, 22, 24 mm (L=38 mm); 27, 30, 32 mm (L=42 mm), 1/4" (6.3 mm): 4, 4.5, 5, 5.5, 6, 7, 8, 9, 10, 11, 12, 13, 14 mm (L=25 mm); CrV 50BV30: 1/2" (12.7 mm): 10, 12, 13, 14, 17, 19 mm (L=76 mm), 1/4" (6.3 mm): 4, 5, 6, 7, 8, 9 mm (L=50 mm); CrV 50BV30: 1/2" (12.7 mm): E10, E12, E14, E16, E18, E20, E22, E24; CrV 6150: 1/2" (12.7 mm): (254 mm), 1/4" (6.3 mm): (152.4 mm); CrV 50BV30: 3/8" (9.5 mm) (F) x 1/2" (12.7 mm) (M), 3/8" (9.5 mm) (F) x 1/4" (6.3 mm) (M); CrV 50BV30: 1/2" (12.7 mm), 1/4" (6.3 mm); CrV 50BV30: 1/2" (12.7 mm): 16, 21 mm; CrV 50BV30: 1/2" (12.7 mm): (255 mm), 1/4" (6.3 mm): (155 mm); 72T; CrMo 440: 1/4" (6.3 mm); (150 mm); CrV 50BV30: 1/4" (6.3 mm): PH1, PH2, PH3 (L=37 mm); AISI S2 / CrV 6150: 1/4" (6.3 mm): PZ2, PZ3 (L=37 mm); AISI S2 / CrV 6150: 1/4" (6.3 mm): T8, T10, T15, T20, T25 (L=37 mm); AISI S2 / CrV 6150: 1/4" (6.3 mm): T10, T15, T20, T25, T40 (L=37 mm); AISI S2 / CrV 6150: 1/4" (6.3 mm): 3, 4, 5, 6 mm (L=37 mm); AISI S2 / CrV 6150: 8, 9, 10, 11, 12, 13, 14, 15, 16, 17, 18, 19 mm; CrV: 8x9, 10x11, 12x13, 14x15 mm; CrV 50BV30: 8x10, 12x13, 17x19 mm; CrV 6140: 3x75, 4x100, 6x150, PH1x75, PH2x100, PH3x150 mm; S2: 180 mm; 160 mm; 300 g

YATO	1/2" (12.7 mm)	1/4" (6.3 mm)	2
YT-38891			

GB Tool set  
D Sechskant-Steckschlüssel-Satz  
PL Zestaw narzędziowy  
RUS Набор инструмента

CZ Sada nástrčných klíčů a ráčny  
H Dugókulcs készlet racsnis hajtókarral  
RO Rotrușa chei tubulare cu antrenor  
F Coffret d'outillage

I Set di utensili  
E Juego de herramientas  
CN 套筒扳手套

BMC & COLOR SLEEVE  
XXL SIZE



122 PCS	1/2" 12.5mm	1/4" 6.3mm
CrV 50BV30	CrV 6150	
CrMo 440	S2	
72T	AS-DRIVE	



1/2" (12.7 mm): 12, 13, 14, 15, 16, 17, 18, 19, 20, 21, 22, 24 mm (L=38 mm); 27, 30, 32 mm (L=42 mm), 1/4" (6.3 mm): 4, 4.5, 5, 5.5, 6, 7, 8, 9, 10, 11, 12, 13, 14 mm (L=25 mm); CrV 50BV30; 1/2" (12.7 mm): 10, 12, 13, 14, 17, 19 mm (L=76 mm), 1/4" (6.3 mm): 4, 5, 6, 7, 8, 9 mm (L=50 mm); CrV 50BV30; 1/2" (12.7 mm): E10, E12, E14, E16, E18, E20, E22, E24; CrV 6150; 1/2" (12.7 mm): (254 mm), 1/4" (6.3 mm): (152.4 mm); CrV 50BV30; 3/8" (9.5 mm) (F) x 1/2" (12.7 mm) (M), 3/8" (9.5 mm) (F) x 1/4" (6.3 mm) (M); CrV 50BV30; 1/2" (12.7 mm), 1/4" (6.3 mm); CrV 50BV30; 1/2" (12.7 mm): 16, 21 mm; CrV 50BV30; 1/2" (12.7 mm): (255 mm), 1/4" (6.3 mm): (155 mm); 72T; CrMo 440; 1/4" (6.3 mm); CrV 50BV30; 1/4" (6.3 mm) x 1/4" (6.3 mm) x 1/4" (6.3 mm); CrV 50BV30; 1/4" (6.3 mm): PH1, PH2, PH3 (L=37 mm); AISI S2; 1/4" (6.3 mm): PH0, PH1, PH2 (L=25 mm); AISI S2; 1/4" (6.3 mm): PZ0, PZ1, PZ2 (L=25 mm); AISI S2; 1/4" (6.3 mm): 4, 5.5, 6.5 mm (L=37 mm); AISI S2 / CrV 6150; 1/4" (6.3 mm): PH1, PH2, PH3 (L=37 mm); AISI S2 / CrV 6150; 1/4" (6.3 mm): PH0, PH1, PH2 (L=25 mm); AISI S2; 1/4" (6.3 mm): PZ0, PZ1, PZ2 (L=25 mm); AISI S2; 1/4" (6.3 mm): 4, 5.5, 6.5 mm (L=37 mm); AISI S2 / CrV 6150; 1/4" (6.3 mm): T8, T10, T15, T20, T25 (L=37 mm); AISI S2 / CrV 6150; 1/4" (6.3 mm): T10, T15, T20, T25, T40 (L=37 mm); AISI S2 / CrV 6150; 1/4" (6.3 mm): 3, 4, 5, 6 mm (L=37 mm); AISI S2 / CrV 6150; 8, 9, 10, 11, 12, 13, 14, 15, 16, 17, 18, 19 mm; CrV; 4x100, 6x150, PH2x100, PH3x150 mm; S2; 180 mm; 160 mm; 160 mm; 250 mm; CrV; 300 g; 2, 2.5, 3, 4, 5, 6, 7, 8, 10 mm; CrV 6150

YATO	1/2" (12.7 mm)	1/4" (6.3 mm)	2
------	----------------	---------------	---

GB Tool set  
D Sechskant-Steckschlüssel-Satz  
PL Zestaw narzędziowy  
RUS Набор инструмента

CZ Sada nástrčných klíčů a ráčny  
H Dugókulcs készlet racsnis hajtókarral  
RO Rotrușa chei tubulare cu antrenor  
F Coffret d'outillage

I Set di utensili  
E Juego de herramientas  
CN 套筒扳手套

BMC & COLOR SLEEVE  
XL SIZE



111 PCS	1/2" 12.5mm	3/8" 10mm	1/4" 6.3mm
CrV 50BV30	CrV 6150	CrMo 440	
S2	72T	AS-DRIVE	



1/2" (12.7 mm): 14, 15, 16, 17, 18, 19, 20, 21, 22, 23, 24 mm (L=38 mm); 27, 30, 32 mm (L=42 mm), 3/8" (9.5 mm): 9, 10, 11, 12, 13, 14, 15, 16 mm (L=28 mm); 17, 18, 19 mm (L=30 mm), 1/4" (6.3 mm): 3.5, 4, 4.5, 5, 5.5, 6, 7, 8, 9, 10, 11, 12, 13 mm (L=25 mm); CrV 50BV30; 1/2" (12.7 mm): (127, 254 mm), 3/8" (9.5 mm): (76, 152.4 mm), 1/4" (6.3 mm): (50.8, 152.4 mm); CrV 50BV30; 3/8" (9.5 mm) (F) x 1/2" (12.7 mm) (M), 1/2" (12.7 mm) (F) x 3/8" (9.5 mm) (M), 3/8" (9.5 mm) (F) x 1/4" (6.3 mm) (M); CrV 50BV30; 1/2" (12.7 mm), 3/8" (9.5 mm), 1/4" (6.3 mm); CrV 50BV30; 1/2" (12.7 mm): 16, 21 mm, 3/8" (9.5 mm): 16, 21 mm; CrV 50BV30; 1/2" (12.7 mm): (255 mm), 3/8" (9.5 mm): (200 mm), 1/4" (6.3 mm): (155 mm); 72T; CrMo 440; 1/4" (6.3 mm): (150 mm); CrV 50BV30; 1/2" (12.7 mm) x 5/16" (7.9 mm), 3/8" (9.5 mm) x 5/16" (7.9 mm); CrV 50BV30; 5/16" (7.9 mm): 6, 6.5, 8 mm (L=30 mm); AISI S2; 5/16" (7.9 mm): PH2, PH3 (L=30 mm); AISI S2; 5/16" (7.9 mm): PZ2, PZ3 (L=30 mm); AISI S2; 5/16" (7.9 mm): T27, T30, T35, T40, T45 (L=30 mm); AISI S2; 5/16" (7.9 mm): 5.5, 6, 6.5 mm (L=30 mm); AISI S2; 1/4" (6.3 mm): 4, 5.5, 6.5 mm (L=37 mm); AISI S2 / CrV 6150; 1/4" (6.3 mm): PH1, PH2 (L=37 mm); AISI S2 / CrV 6150; 1/4" (6.3 mm): PZ1, PZ2 (L=37 mm); AISI S2 / CrV 6150; 1/4" (6.3 mm): T8, T10, T15, T20, T25 (L=37 mm); AISI S2 / CrV 6150; 1/4" (6.3 mm): T10, T15, T20, T25, T40 (L=37 mm); AISI S2 / CrV 6150; 1/4" (6.3 mm): 3, 4, 5, 6 mm (L=37 mm); AISI S2 / CrV 6150; 8, 9, 10, 11, 12, 13, 14, 15, 16, 17, 18, 19 mm; CrV; 1.5, 2, 2.5 mm; CrV 6150

YATO	1/2" (12.7 mm)	3/8" (9.5 mm)	1/4" (6.3 mm)	2
------	----------------	---------------	---------------	---

GB Tool set  
D Sechskant-Steckschlüssel-Satz  
PL Zestaw narzędziowy  
RUS Набор инструмента

CZ Sada nástrčných klíčů a ráčny  
H Dugókulcs készlet racsnis hajtókarral  
RO Rotruşa chei tubulare cu antrenor  
F Coffret d'outillage

I Set di utensili  
E Juego de herramientas  
CN 套筒扳手组套

BMC & COLOR SLEEVE  
XL SIZE



1/2" 12.5mm	3/8" 10mm	1/4" 6.3mm
CrV 50BV30	CrV 6150	CrMo 440
S2	72T	AS-DRIVE

2



120  
PCS  
METRIC  
& S.A.E.

1/2" (12.7 mm): 20, 21, 22, 24 mm (L=38 mm); 27, 30, 32 mm (L=42 mm), 3/8" (9.5 mm): 9, 10, 11, 12, 13, 14, 15, 16 mm (L=28 mm); 17, 18, 19 mm (L=30 mm), 1/4" (6.3 mm): 4, 5, 6, 7, 8, 9, 10, 11, 12, 13 mm (L=25 mm); CrV 50BV30: 13, 14, 15, 17 mm (L=63 mm), 1/4" (6.3 mm): 8, 9, 10, 12 mm (L=50 mm); CrV 50BV30: 1/2" (12.7 mm) x 15/16" (23.8 mm), 1/2" (12.7 mm) x 1" (25.4 mm), 1/2" (12.7 mm) x 1-1/16" (27.0 mm), 1/2" (12.7 mm) x 1-1/4" (31.8 mm), 3/8" (9.5 mm) x 3/8" (9.5 mm), 3/8" (9.5 mm) x 7/16" (11.1 mm), 3/8" (9.5 mm) x 1/2" (12.7 mm), 3/8" (9.5 mm) x 9/16" (14.3 mm), 3/8" (9.5 mm) x 5/8" (15.9 mm), 3/8" (9.5 mm) x 11/16" (17.5 mm), 3/8" (9.5 mm) x 3/4" (19.0 mm), 3/8" (9.5 mm) x 13/16" (20.6 mm), 3/8" (9.5 mm) x 7/8" (22.2 mm), 1/4" (6.3 mm) x 5/32" (4.0 mm), 1/4" (6.3 mm) x 3/16" (4.8 mm), 1/4" (6.3 mm) x 7/32" (5.6 mm), 1/4" (6.3 mm) x 1/4" (6.3 mm), 1/4" (6.3 mm) x 9/32" (7.1 mm), 1/4" (6.3 mm) x 5/16" (7.9 mm), 1/4" (6.3 mm) x 11/32" (8.7 mm), 1/4" (6.3 mm) x 3/8" (9.5 mm), 1/4" (6.3 mm) x 7/16" (11.1 mm), 1/4" (6.3 mm) x 1/2" (12.7 mm); CrV 50BV30: 1/2" (12.7 mm): 17, 19, 21, 23 mm; CrV 50BV30: 3/8" (9.5 mm): E8, E10, E11, E12, E14, E16, E18, E20; CrV 6150: 1/2" (12.7 mm): (127, 254 mm), 3/8" (9.5 mm): (76, 152.4 mm), 1/4" (6.3 mm): (50.8 mm); CrV 50BV30: 1/2" (12.7 mm): 3/8" (9.5 mm), 1/4" (6.3 mm); CrV 50BV30: 3/8" (9.5 mm): 16, 21 mm; CrV 50BV30: 1/2" (12.7 mm): (255 mm), 3/8" (9.5 mm): (200 mm), 1/4" (6.3 mm): (155 mm); 72T; CrMo 440: 1/4" (6.3 mm): (150 mm); CrV 50BV30: 1/4" (6.3 mm) x 1/4" (6.3 mm); CrV 50BV30: 1/4" (6.3 mm): T10, T15, T20, T25, T27, T30, T40 (L=25 mm); AISI S2: 3/8" (9.5 mm): 5.5, 6.5 mm (L=50 mm); AISI S2 / CrV 6150: 3/8" (9.5 mm): PH1, PH2 (L=50 mm); AISI S2 / CrV 6150: 3/8" (9.5 mm): PZ1, PZ2 (L=50 mm); AISI S2 / CrV 6150: 3/8" (9.5 mm): T20, T30, T40, T45, T50, T55, T60 (L=50 mm); AISI S2 / CrV 6150: 3/8" (9.5 mm): 3, 4, 5, 6 mm (L=50 mm); AISI S2 / CrV 6150: 8, 9, 10, 11, 12, 13, 14, 17, 18, 19 mm; CrV

YATO	○	○	○	□
YT-38801	1/2" (12.7 mm)	3/8" (9.5 mm)	1/4" (6.3 mm)	2



128  
PCS

1/2" (12.7 mm): 14, 15, 16, 17, 18, 19, 20, 21, 22, 24 mm (L=38 mm); 27, 30, 32 mm (L=42 mm), 3/8" (9.5 mm): 10, 11, 12, 13, 14, 15, 16 mm (L=28 mm); 17, 18 mm (L=30 mm), 1/4" (6.3 mm): 6, 7, 8, 9, 10, 11, 12, 13 mm (L=25 mm); CrV 50BV30: 1/2" (12.7 mm): 17, 18, 19, 22 mm (L=76 mm), 3/8" (9.5 mm): 8, 10, 12, 13, 14, 15 mm (L=63 mm), 1/4" (6.3 mm): 6, 7, 8, 10, 12, 13 mm (L=50 mm); CrV 50BV30: 1/2" (12.7 mm): 17, 19, 21, 22 mm; CrV 50BV30: 3/8" (9.5 mm): E8, E10, E11, E12, E14, E16; CrV 6150: 1/2" (12.7 mm): (127, 254 mm), 3/8" (9.5 mm): (152.4, 254 mm), 1/4" (6.3 mm): (50.8, 101.6 mm); CrV 50BV30: 3/8" (9.5 mm) (F) x 1/2" (12.7 mm) (M); CrV 50BV30: 1/2" (12.7 mm), 3/8" (9.5 mm), 1/4" (6.3 mm); CrV 50BV30: 1/2" (12.7 mm): 16, 21 mm; CrV 50BV30: 3/8" (9.5 mm): (198 mm), 1/4" (6.3 mm): (152.4 mm); CrV 50BV30: 1/2" (12.7 mm): (255 mm), 3/8" (9.5 mm): (200 mm), 1/4" (6.3 mm); 72T; CrMo 440: 1/4" (6.3 mm); CrV 50BV30: 1/4" (6.3 mm) x 1/4" (6.3 mm); CrV 50BV30: 1/4" (6.3 mm): T8, T10 (L=25 mm); AISI S2: 3/8" (9.5 mm): 5.5, 6.5 mm (L=70 mm); AISI S2: 3/8" (9.5 mm): PH1, PH2, PH3 (L=70 mm); AISI S2: 3/8" (9.5 mm): T20, T30, T40, T45, T50, T55 (L=70 mm); AISI S2: 3/8" (9.5 mm): 6, 7, 8, 10, 12 mm (L=70 mm); AISI S2: 1/4" (6.3 mm): PZ1, PZ2 (L=25 mm); AISI S2: 1/4" (6.3 mm): T8, T10 (L=25 mm); AISI S2: 1/4" (6.3 mm): 4.0, 5.5, 6.5 mm (L=37 mm); AISI S2 / CrV 6150: 1/4" (6.3 mm): PH1, PH2 (L=37 mm); AISI S2 / CrV 6150: 1/4" (6.3 mm): T8, T10, T15, T20, T25, T30, T40 (L=37 mm); AISI S2 / CrV 6150: 1/4" (6.3 mm): 3, 4, 5, 6 mm (L=37 mm); AISI S2 / CrV 6150: 8, 10, 12, 13, 14, 15, 16, 17, 18, 19 mm; CrV: 1.5, 2, 2.5 mm; CrV 6150

YATO	○	○	○	□
YT-38872	1/2" (12.7 mm)	3/8" (9.5 mm)	1/4" (6.3 mm)	2

GB Tool set  
D Sechskant-Steckschlüssel-Satz  
PL Zestaw narzędziowy  
RUS Набор инструмента

CZ Sada nástrčných klíčů a ráčny  
H Dugókulcs készlet racsnis hajtókarral  
RO Rotruşa chei tubulare cu antrenor  
F Coffret d'outillage

I Set di utensili  
E Juego de herramientas  
CN 套筒扳手组套

BMC & COLOR  
SLEEVE  
XXL SIZE



1/2" 12.5mm	3/8" 10mm	1/4" 6.3mm
CrV 50BV30	CrV 6150	CrMo 440
S2	72T	AS-DRIVE

2



**129**  
PCS

1/2" (12.7 mm): 12, 13, 14, 15, 16, 17, 18, 19, 20, 21, 22, 24 mm (L=38 mm); 27, 30, 32 mm (L=42 mm), 3/8" (9.5 mm): 10, 11, 12, 13, 14, 15, 16 mm (L=28 mm); 17, 18, 19 mm (L=30 mm), 1/4" (6.3 mm): 4, 4.5, 5, 5.5, 6, 7, 8, 9, 10, 11, 12, 13, 14 mm (L=25 mm); CrV 50BV30: 1/2" (12.7 mm): 10, 12, 13, 14, 17, 19 mm (L=76 mm), 1/4" (6.3 mm): 4, 5, 6, 7, 8, 9 mm (L=50 mm); CrV 50BV30: 1/2" (12.7 mm): 17, 19, 21, 23 mm; CrV 50BV30: 3/8" (9.5 mm): E8, E10, E11, E12, E14, E16, E18, E20; CrV 6150: 1/2" (12.7 mm): (127, 254 mm), 3/8" (9.5 mm): (76, 152.4 mm), 1/4" (6.3 mm): (50.8 mm); CrV 50BV30: 1/2" (12.7 mm), 3/8" (9.5 mm), 1/4" (6.3 mm); CrV 50BV30: 3/8" (9.5 mm): 16, 21 mm; CrV 50BV30: 1/2" (12.7 mm): (255 mm), 3/8" (9.5 mm): (200 mm), 1/4" (6.3 mm): (155 mm); 72T; CrMo 440: 1/4" (6.3 mm); (150 mm); CrV 50BV30: 1/4" (6.3 mm); 3/8" (9.5 mm): 4, 5.5, 6.5 mm (L=50 mm); AISI S2 / CrV 6150: 3/8" (9.5 mm): PH1, PH2, PH3 (L=50 mm); AISI S2 / CrV 6150: 3/8" (9.5 mm): PZ1, PZ2, PZ3 (L=50 mm); AISI S2 / CrV 6150: 3/8" (9.5 mm): T20, T30, T40, T45, T50, T55, T60 (L=50 mm); AISI S2 / CrV 6150: 3/8" (9.5 mm): 3, 4, 5, 6, 8, 10 mm (L=50 mm); AISI S2 / CrV 6150: 8, 10, 11, 12, 13, 14, 15, 16, 17, 18, 19, 22 mm; CrV: 3x75, 4x100, 6x150, PH1x75, PH2x100, PH3x150 mm; S2: 160 mm; 160 mm; 160 mm; 1.5, 2, 2.5, 3, 4, 5, 6, 7, 8, 10 mm; CrV 6150

YATO	1/2" (12.7 mm)	3/8" (9.5 mm)	1/4" (6.3 mm)	2
YT-38881				



**150**  
PCS  
METRIC & S.A.E.  
CrV 6140

1/2" (12.7 mm): 20, 21, 22, 24 mm (L=38 mm); 27, 30, 32 mm (L=42 mm), 3/8" (9.5 mm): 9, 10, 11, 12, 13, 14, 15, 16 mm (L=28 mm); 17, 18, 19 mm (L=30 mm), 1/4" (6.3 mm): 4, 5, 6, 7, 8, 9, 10, 11, 12, 13 mm (L=25 mm); CrV 50BV30: 1/2" (12.7 mm): 10, 12, 13, 14, 17, 19 mm (L=76 mm), 3/8" (9.5 mm): 10, 11, 12, 13, 14, 15 mm (L=63 mm), 1/4" (6.3 mm): 4, 5, 6, 7, 8, 9 mm (L=50 mm); CrV 50BV30: 1/2" (12.7 mm) x 15/16" (23.8 mm), 1/2" (12.7 mm) x 1" (25.4 mm), 1/2" (12.7 mm) x 1-1/16" (27.0 mm), 1/2" (12.7 mm) x 1-1/4" (31.8 mm), 3/8" (9.5 mm) x 3/8" (9.5 mm), 3/8" (9.5 mm) x 7/16" (11.1 mm), 3/8" (9.5 mm) x 1/2" (12.7 mm), 3/8" (9.5 mm) x 9/16" (14.3 mm), 3/8" (9.5 mm) x 5/8" (15.9 mm), 3/8" (9.5 mm) x 11/16" (17.5 mm), 3/8" (9.5 mm) x 3/4" (19.0 mm), 3/8" (9.5 mm) x 13/16" (20.6 mm), 3/8" (9.5 mm) x 7/8" (22.2 mm), 1/4" (6.3 mm) x 5/32" (4.0 mm), 1/4" (6.3 mm) x 3/16" (4.8 mm), 1/4" (6.3 mm) x 7/32" (5.6 mm), 1/4" (6.3 mm) x 1/4" (6.3 mm), 1/4" (6.3 mm) x 9/32" (7.1 mm), 1/4" (6.3 mm) x 5/16" (7.9 mm), 1/4" (6.3 mm) x 11/32" (8.7 mm), 1/4" (6.3 mm) x 3/8" (9.5 mm), 1/4" (6.3 mm) x 7/16" (11.1 mm), 1/4" (6.3 mm) x 1/2" (12.7 mm); CrV 50BV30: 1/2" (12.7 mm): 17, 19, 21, 23 mm; CrV 50BV30: 3/8" (9.5 mm): E8, E10, E11, E12, E14, E16, E18, E20; CrV 6150: 1/2" (12.7 mm): (127, 254 mm), 3/8" (9.5 mm): (76, 152.4 mm), 1/4" (6.3 mm): (50.8 mm); CrV 50BV30: 1/2" (12.7 mm), 3/8" (9.5 mm), 1/4" (6.3 mm); CrV 50BV30: 3/8" (9.5 mm): 16, 21 mm; CrV 50BV30: 1/2" (12.7 mm): (255 mm), 3/8" (9.5 mm): (200 mm), 1/4" (6.3 mm): (155 mm); 72T; CrMo 440: 1/4" (6.3 mm); (150 mm); CrV 50BV30: 1/4" (6.3 mm); 3/8" (9.5 mm): 4, 5.5, 6.5 mm (L=50 mm); AISI S2 / CrV 6150: 3/8" (9.5 mm): PH1, PH2, PH3 (L=50 mm); AISI S2 / CrV 6150: 3/8" (9.5 mm): PZ1, PZ2, PZ3 (L=50 mm); AISI S2 / CrV 6150: 3/8" (9.5 mm): T10, T15, T20, T25, T27, T30, T40 (L=25 mm); AISI S2 / CrV 6150: 3/8" (9.5 mm): 3, 4, 5, 6, 8, 10 mm (L=50 mm); AISI S2 / CrV 6150: 8, 9, 10, 11, 12, 13, 14, 15, 16, 17, 18, 19 mm; CrV: 8x10, 12x13, 17x19 mm; CrV 6140: 1.5, 2, 2.5, 3, 4, 5, 6, 7, 8, 10 mm; CrV 6150

YATO	1/2" (12.7 mm)	3/8" (9.5 mm)	1/4" (6.3 mm)	2
YT-38811				



GB Tool set  
D Sechskant-Steckschlüssel-Satz  
PL Zestaw narzędziowy  
RUS Набор инструмента

CZ Sada nástrčných klíčů a ráčny  
H Dugókulcs készlet racsnis hajtókarral  
RO Roturusa chei tubulare cu antrenor  
F Coffret d'outillage

I Set di utensili  
E Juego de herramientas  
CN 套筒扳手组套

1/2" 12.5mm	3/8" 10mm	1/4" 6.3mm	CrV 50BV30	CrV 6150
CrV 40	CrMo 440	S2	72T	AS-DRIVE



**173**  
PCS

BMC & COLOR  
SLEEVE  
XL SIZE



1/2" (12.7 mm): 10, 11, 12, 13, 14, 15, 16, 17, 18, 19, 20, 21, 22, 23, 24 mm (L=38 mm); 27, 30, 32 mm (L=42 mm); 3/8" (9.5 mm): 10, 11, 12, 13, 14, 15, 16 mm (L=28 mm); 17, 18, 19 mm (L=30 mm); 1/4" (6.3 mm): 4, 4.5, 5, 5.5, 6, 7, 8, 9, 10, 11, 12, 13, 14 mm (L=25 mm); CrV 50BV30: 1/2" (12.7 mm): 16, 17, 18, 19, 22 mm (L=76 mm); 3/8" (9.5 mm): 10, 11, 12, 13, 14, 15 mm (L=63 mm); 1/4" (6.3 mm): 4, 5, 6, 7, 8, 9, 10 mm (L=50 mm); CrV 50BV30: 1/2" (12.7 mm): E18, E20, E24, 3/8" (9.5 mm): E10, E11, E12, E14, E16, 1/4" (6.3 mm): E4, E5, E6, E7, E8; CrV 6150: 1/2" (12.7 mm): (127, 254 mm); 3/8" (9.5 mm): (152.4 mm); 1/4" (6.3 mm): (50.8, 101.6 mm); CrV 50BV30: 3/8" (9.5 mm) (F) x 1/2" (12.7 mm); CrV 50BV30: 1/2" (12.7 mm), 3/8" (9.5 mm), 1/4" (6.3 mm); CrV 50BV30: 1/2" (12.7 mm): 16, 21 mm, 3/8" (9.5 mm): 18 mm; CrV 50BV30: 1/4" (6.3 mm); (152.4 mm); CrV 40: 1/2" (12.7 mm): (255 mm); 3/8" (9.5 mm): (200 mm); 1/4" (6.3 mm): (155 mm); 72T; CrMo 440: 1/4" (6.3 mm): (150 mm); CrV 50BV30: 1/2" (12.7 mm) x 5/16" (7.9 mm), 3/8" (9.5 mm) x 5/16" (7.9 mm); CrV 50BV30: 1/4" (6.3 mm) x 1/4" (6.3 mm); CrV 50BV30: 5/16" (7.9 mm); 8, 10, 12 mm (L=30 mm); AISI S2: 5/16" (7.9 mm): PH3, PH4 (L=30 mm); AISI S2: 5/16" (7.9 mm): PZ3, PZ4 (L=30 mm); AISI S2: 5/16" (7.9 mm): T40, T45, T50, T55, T60, T70 (L=30 mm); AISI S2: 5/16" (7.9 mm): T40, T45, T50, T55, T60, T70 (L=30 mm); AISI S2: 5/16" (7.9 mm): 7, 8, 10, 12, 14 mm (L=30 mm); AISI S2: 1/4" (6.3 mm): T5, T6, T7 (L=25 mm); AISI S2: 1/4" (6.3 mm): T7, T10, T15, T20, T25, T27, T30, T40, T45 (L=25 mm); AISI S2: 1/4" (6.3 mm): M5, M6, M8 (L=25 mm); AISI S2: 1/4" (6.3 mm): RM5, RM6, RM7, RM8, RM9 (L=25 mm); AISI S2: 1/4" (6.3 mm): 4, 5.5, 6.5, 7 mm (L=37 mm); AISI S2 / CrV 6150: 1/4" (6.3 mm): PH0, PH1, PH2 (L=37 mm); AISI S2 / CrV 6150: 1/4" (6.3 mm): P20, PZ1, PZ2 (L=37 mm); AISI S2 / CrV 6150: 1/4" (6.3 mm): T8, T9, T10, T15, T20, T25, T27, T30 (L=37 mm); AISI S2 / CrV 6150: 1/4" (6.3 mm): T8, T9, T10, T15, T20, T25, T27, T30 (L=37 mm); AISI S2 / CrV 6150: 1/4" (6.3 mm): 3, 4, 5, 6 mm (L=37 mm); AISI S2 / CrV 6150: 1.25, 1.5, 2, 2.5, 3, 4, 5 mm; CrV 6150

<b>YATO</b>	○	○	○	📦
YT-38931	1/2" (12.7 mm)	3/8" (9.5 mm)	1/4" (6.3 mm)	2

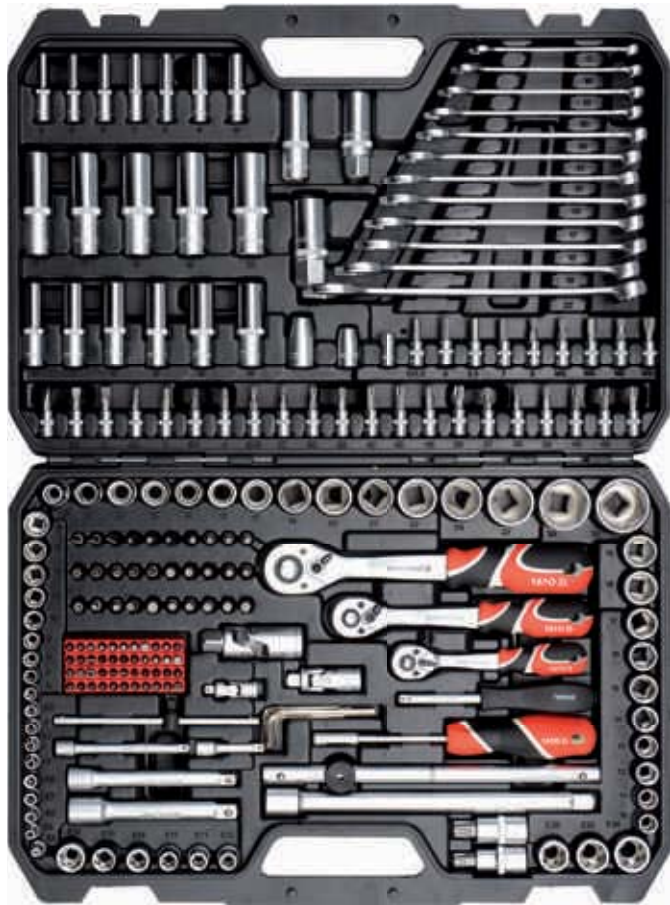

**216**  
PCS



BMC & COLOR  
SLEEVE  
XXL SIZE



1/2" (12.7 mm): 10, 11, 12, 13, 14, 15, 17, 19, 20, 21, 22, 24 mm (L=38 mm); 27, 30, 32 mm (L=42 mm); 3/8" (9.5 mm): 10, 11, 12, 13, 14, 15, 16 mm (L=28 mm); 17, 18, 19 mm (L=30 mm); 1/4" (6.3 mm): 4, 4.5, 5, 5.5, 6, 7, 8, 9, 10, 11, 12, 13, 14 mm (L=25 mm); CrV 50BV30: 1/2" (12.7 mm): 16, 17, 18, 19, 22 mm (L=76 mm); 3/8" (9.5 mm): 10, 11, 12, 13, 14, 15 mm (L=63 mm); 1/4" (6.3 mm): 4, 5, 6, 7, 8, 9, 10 mm (L=50 mm); CrV 50BV30: 1/2" (12.7 mm): E20, E22, E24, 3/8" (9.5 mm): E10, E11, E12, E14, E16, E18, 1/4" (6.3 mm): E4, E5, E6, E7, E8; CrV 6150: 1/2" (12.7 mm): (127, 254 mm); 3/8" (9.5 mm): (125 mm); 1/4" (6.3 mm): (50.8, 101.6 mm); CrV 50BV30: 1/2" (12.7 mm), 3/8" (9.5 mm), 1/4" (6.3 mm); CrV 50BV30: 1/2" (12.7 mm): 16, 21 mm, 3/8" (9.5 mm): 18 mm; CrV 50BV30: 1/2" (12.7 mm); (255 mm); 3/8" (9.5 mm): (200 mm); 1/4" (6.3 mm): (155 mm); 72T; CrMo 440: 1/4" (6.3 mm): (150 mm); CrV 50BV30: 1/4" (6.3 mm); (200 mm); CrV 6150: 1/2" (12.7 mm) x 5/16" (7.9 mm), 3/8" (9.5 mm) x 5/16" (7.9 mm); CrV 50BV30: 1/4" (6.3 mm) x 1/4" (6.3 mm); CrV 50BV30: 5/16" (7.9 mm); 5, 6, 6.5, 7, 8 mm (L=30 mm); AISI S2: 5/16" (7.9 mm): PH3, PH4 (L=30 mm); AISI S2: 5/16" (7.9 mm): PZ3, PZ4 (L=30 mm); AISI S2: 5/16" (7.9 mm): T25, T27, T30, T35, 2xT40, T45, T50 (L=30 mm); AISI S2: 5/16" (7.9 mm): T27, T30, T35, T40, T45, T50 (L=30 mm); AISI S2: 5/16" (7.9 mm): 5, 6, 6.5, 7, 8 mm (L=30 mm); AISI S2: 5/16" (7.9 mm): M5, M6, M8, M10 (L=30 mm); AISI S2: 1/4" (6.3 mm): 4, 5.5, 6.5 mm (L=25 mm); AISI S2: 1/4" (6.3 mm): PH1, PH2 (L=25 mm); AISI S2: 1/4" (6.3 mm): PZ1, PZ2 (L=25 mm); AISI S2: 1/4" (6.3 mm): T8, T10, T15, T20, T25 (L=25 mm); AISI S2: 1/4" (6.3 mm): T8, 2xT10, 2xT15, 2xT20, 2xT25, T40 (L=25 mm); AISI S2: 1/4" (6.3 mm): 3, 4, 5, 6 mm (L=25 mm); AISI S2: 1/4" (6.3 mm): 3, 4, 5, 6 mm (L=25 mm); AISI S2: 1/4" (6.3 mm): M5, M6, M8 (L=25 mm); AISI S2: 1/4" (6.3 mm): S1, S2 (L=25 mm); AISI S2: 1/4" (6.3 mm): 1, 2, 3 mm (L=25 mm); AISI S2: 1/4" (6.3 mm): 6, 8, 10 mm (L=25 mm); AISI S2: 1/4" (6.3 mm): 4, 6, 8 mm (L=25 mm); AISI S2: 1/2" (12.7 mm): T55, T60 (L=50 mm); AISI S2 / CrV 6150: 1/4" (6.3 mm): 6, 6.5, 8 mm (L=37 mm); AISI S2 / CrV 6150: 1/4" (6.3 mm): PH3, PH4 (L=37 mm); AISI S2 / CrV 6150: 1/4" (6.3 mm): PZ3, PZ4 (L=37 mm); AISI S2 / CrV 6150: 1/4" (6.3 mm): T27, T30, T35, T40, T45, T50 (L=37 mm); AISI S2 / CrV 6150: 1/4" (6.3 mm): T27, T30, T35, T40, T45, T50 (L=37 mm); AISI S2 / CrV 6150: 1/4" (6.3 mm): 5.5, 6, 6.5, 7, 8 mm (L=37 mm); AISI S2 / CrV 6150: 1/4" (6.3 mm): M5, M6, M8, M10 (L=37 mm); AISI S2 / CrV 6150: 1/4" (6.3 mm): 8, 10, 11, 12, 13, 14, 15, 16, 17, 18, 19, 22 mm; CrV: 1.27, 1.5, 2, 2.5, 3, 4, 5 mm; CrV 6150

<b>YATO</b>	○	○	○	📦
YT-38841	1/2" (12.7 mm)	3/8" (9.5 mm)	1/4" (6.3 mm)	2

GB Tool set  
 D Sechskant-Steckschlüssel-Satz  
 PL Zestaw narzędziowy  
 RUS Набор инструментов  
 CZ Sada nástrčných klíčů a ráčny  
 H Dugókulcs készlet racsnis hajtókarral

RO Rotrușă de tubulare cu antrenor  
 F Coffret d'outillage  
 I Set di utensili  
 E Juego de herramientas  
 CN 套筒扳手组套

BMC & COLOR  
 SLEEVE  
 XXXL SIZE



225 PCS	1/2" 12.5mm	3/8" 10mm	1/4" 6.3mm
	METRIC & S.A.E.	CrV 50BV30	CrV 6150
	CrV 40	CrMo 440	S2
	72T	AS-DRIVE	



1/2" (12.7 mm): 10, 13, 15, 16, 17, 18, 19, 20, 21, 22, 23, 24 mm (L=38 mm); 27, 30, 32 mm (L=42 mm); 3/8" (9.5 mm): 10, 11, 12, 13, 14, 15, 16 mm (L=28 mm); 17, 18, 19 mm (L=30 mm); 1/4" (6.3 mm): 3.5, 4, 4.5, 5, 5.5, 6, 7, 8, 9, 10, 11, 12, 13, 14 mm (L=25 mm); CrV 50BV30: 1/2" (12.7 mm): 10, 11, 12, 13, 14, 15, 17, 19, 21 mm (L=76 mm); 3/8" (9.5 mm): 6, 7, 8, 9, 10 mm (L=63 mm); CrV 50BV30: 1/2" (12.7 mm) x 7/16" (11.1 mm), 1/2" (12.7 mm) x 1/2" (12.7 mm), 1/2" (12.7 mm) x 9/16" (14.3 mm), 1/2" (12.7 mm) x 5/8" (15.9 mm), 1/2" (12.7 mm) x 11/16" (17.5 mm), 1/2" (12.7 mm) x 3/4" (19.0 mm), 1/2" (12.7 mm) x 13/16" (20.6 mm), 1/2" (12.7 mm) x 7/8" (22.2 mm), 1/4" (6.3 mm) x 1/4" (6.3 mm), 1/4" (6.3 mm) x 9/32" (7.1 mm), 1/4" (6.3 mm) x 5/16" (7.9 mm), 1/4" (6.3 mm) x 11/32" (8.7 mm), 1/4" (6.3 mm) x 3/8" (9.5 mm); CrV 50BV30: 1/2" (12.7 mm): 17, 19, 21 mm; CrV 50BV30: 1/2" (12.7 mm): E16, E18, E20, E22, E24, 3/8" (9.5 mm): E10, E11, E12, E14, 1/4" (6.3 mm): E4, E5, E6, E7, E8; CrV 6150: 1/2" (12.7 mm): (127, 254 mm), 3/8" (9.5 mm): (76, 254 mm), 1/4" (6.3 mm): (50.8, 101.6 mm); CrV 50BV30: 3/8" (9.5 mm) (F) x 1/2" (12.7 mm) (M), 1/2" (12.7 mm) (F) x 3/8" (9.5 mm) (M); CrV 50BV30: 1/2" (12.7 mm), 3/8" (9.5 mm), 1/4" (6.3 mm); CrV 50BV30: 1/2" (12.7 mm): 16, 21 mm (L=64 mm); 3/8" (9.5 mm): 18 mm (L=63 mm); CrV 50BV30: 1/4" (6.3 mm): (152.4 mm); CrV 40: 1/2" (12.7 mm): (255 mm), 3/8" (9.5 mm): (200 mm), 1/4" (6.3 mm): (155 mm); 72T: CrMo 440: 1/4" (6.3 mm): (150 mm); CrV 50BV30: 1/4" (6.3 mm): (200 mm); CrV 6140: 1/2" (12.7 mm) x 5/16" (7.9 mm), 3/8" (9.5 mm) x 5/16" (7.9 mm), 3/8" (9.5 mm) x 1/4" (6.3 mm); CrV 50BV30: 1/4" (6.3 mm) x 1/4" (6.3 mm); CrV 50BV30: 1/4" (6.3 mm) x 3/8" (9.5 mm) (L=50 mm), 1/4" (6.3 mm) x 1/4" (6.3 mm) (L=50 mm), 1/4" (6.3 mm) x 1/4" (6.3 mm) (L=25 mm); CrV 50BV30: 1/4" (6.3 mm) (L=60 mm); 5/16" (7.9 mm): T20, T25, T27, T30, T40, T45, T50, T55 (L=75 mm); AISI S2: 5/16" (7.9 mm): 8, 10 mm (L=30 mm); AISI S2: 5/16" (7.9 mm): PH3, PH4 (L=30 mm); AISI S2: 5/16" (7.9 mm): PZ3, PZ4 (L=30 mm); AISI S2: 5/16" (7.9 mm): T40, T45, T50, T55, T60, T70 (L=30 mm); AISI S2: 5/16" (7.9 mm): T40, T45, T50, T55, T60, T70 (L=30 mm); AISI S2: 5/16" (7.9 mm): 10, 12, 14 mm (L=30 mm); AISI S2: 1/4" (6.3 mm): 3, 4, 5.5, 6.5, 7, 8, 9 mm (L=25 mm); AISI S2: 1/4" (6.3 mm): PH0, PH1, PH2, PH3 (L=25 mm); AISI S2: 1/4" (6.3 mm): PZ0, PZ1, PZ2, PZ3 (L=25 mm); AISI S2: 1/4" (6.3 mm): T8, T9, T10, T15, T20, T25, T27, T30 (L=25 mm); AISI S2: 1/4" (6.3 mm): T8, T9, T10, T15, T20, T25, T27, T30 (L=25 mm); AISI S2: 1/4" (6.3 mm): 3, 4, 5, 6, 7, 8 mm (L=25 mm); AISI S2: 1/4" (6.3 mm): 3, 4, 5, 6, 7, 8 mm (L=25 mm); AISI S2: 1/4" (6.3 mm): 4, 5, 6, 7, 8 mm (L=25 mm); AISI S2: 1/4" (6.3 mm): TW1, TW2, TW3, TW4 (L=25 mm); AISI S2: 1/4" (6.3 mm): 6, 8, 10 mm (L=25 mm); : 1/4" (6.3 mm): 4, 6, 8, 10 mm (L=25 mm); AISI S2: 8, 9, 10, 11, 12, 13, 14, 15, 16, 17, 19, 22 mm; CrV: 6x38, PH2X38: S2; 180 mm; 250 mm; CrV: 2, 2.5, 3, 4, 5, 6, 7, 8, 10, 12 mm; CrV 6150

<b>YATO</b>				
YT-38941	1/2" (12.7 mm)	3/8" (9.5 mm)	1/4" (6.3 mm)	2



GB Socket set  
D Sechskant-Steckschlüssel-Satz  
PL Komplet nasadek długich  
RUS Набор насадок

CZ Sada nástrčných klíčů  
H Dugókulcs készlet  
RO Trusă chei tubulare  
F Set de douilles longues

I Serie di chiavi a bussola lunghi  
E Juego de herramientas  
CN 长套筒组套

8 PCS  
1/4" 6.3mm  
CrV 50BV30  
AS-DRIVE



1/4" (6.3 mm): 5.5, 6, 7, 8, 9, 10, 12, 13 mm (L=50 mm); CrV 50BV30

PLASTIC HANGER



<b>YATO</b>	1/4" (6.3 mm)	10
YT-1443	1/4" (6.3 mm)	10

GB Tool set  
D Sechskant-Steckschlüssel-Satz  
PL Zestaw narzędziowy  
RUS Набор инструмента  
CZ Sada nástrčných klíčů a ráčny  
H Dugókulcs készlet racsnis hajtókkal

RO Rotrusa chei tubulare cu antrenor  
F Coffret d'outillage  
I Set di utensili  
E Juego de herramientas  
CN 套筒扳手组套

METAL CASE & COLOR SLEEVE



1/4" 6.3mm  
CrV 50BV30  
CrV 6140  
72T  
AS-DRIVE



15 PCS

1/4" (6.3 mm): 4, 5, 6, 7, 8, 9, 10, 12, 13 mm (L=25 mm); CrV 50BV30;  
1/4" (6.3 mm): (50.8, 152.4 mm); CrV 50BV30;  
1/4" (6.3 mm); CrV 50BV30;  
1/4" (6.3 mm): (127 mm); 72T; CrV 6140;  
1/4" (6.3 mm): (150 mm); CrV 50BV30;

<b>YATO</b>	1/4" (6.3 mm)	10
YT-1441	1/4" (6.3 mm)	10



23 PCS

1/4" (6.3 mm): 4, 5, 6, 7, 8, 9, 10, 12, 13 mm (L=25 mm); CrV 50BV30;  
1/4" (6.3 mm): 4, 5, 6, 7, 8, 9, 10, 12, 13 mm (L=50 mm); CrV 50BV30;  
1/4" (6.3 mm): (50.8, 152.4 mm); CrV 50BV30;  
1/4" (6.3 mm); CrV 50BV30;  
1/4" (6.3 mm): (127 mm); 72T; CrV 6140;  
1/4" (6.3 mm): (150 mm); CrV 50BV30

<b>YATO</b>	1/4" (6.3 mm)	10
YT-1442	1/4" (6.3 mm)	10

GB Tool set  
 D Sechskant-Steckschlüssel-Satz  
 PL Zestaw narzędziowy  
 RUS Набор инструментов  
 CZ Sada nástrčných klíčů a ráčny  
 H Dugókulcs készlet racsnis hajtókarral

RO Rotrușă de tubulare cu antrenor  
 F Coffret d'outillage  
 I Set di utensili  
 E Juego de herramientas  
 CN 套筒扳手组套

BMC & COLOR SLEEVE  
 XS SIZE



1/4"  
 6.3mm  
 CrV  
 50BV30  
 CrV  
 6140  
 72T  
 AS-DRIVE

2



**15**  
 PCS

1/4" (6.3 mm): 4, 5, 6, 7, 8, 9, 10, 12, 13 mm (L=25 mm); CrV 50BV30;  
 1/4" (6.3 mm); (50.8, 152.4 mm); CrV 50BV30;  
 1/4" (6.3 mm); CrV 50BV30;  
 1/4" (6.3 mm); (155 mm); 72T; CrV 6140;  
 1/4" (6.3 mm); (150 mm); CrV 50BV30

YATO		
YT-1444	1/4" (6.3 mm)	10



**20**  
 PCS

1/4" (6.3 mm): 3.5, 4, 4.5, 5, 5.5, 6, 7, 8, 9, 10, 11, 12, 13, 14 mm  
 (L=25 mm); CrV 50BV30;  
 1/4" (6.3 mm); (50.8, 152.4 mm); CrV 50BV30;  
 1/4" (6.3 mm); CrV 50BV30;  
 1/4" (6.3 mm); (152.4 mm); CrV 50BV30;  
 1/4" (6.3 mm); (155 mm); 72T; CrV 6140;  
 1/4" (6.3 mm); (150 mm); CrV 50BV30

YATO		
YT-1449	1/4" (6.3 mm)	10



**23**  
 PCS

1/4" (6.3 mm): 4, 5, 6, 7, 8, 9, 10, 12, 13 mm (L=25 mm); CrV 50BV30;  
 1/4" (6.3 mm): 4, 5, 6, 7, 8, 9, 10, 12, 13 mm (L=50 mm); CrV 50BV30;  
 1/4" (6.3 mm); (50.8, 152.4 mm); CrV 50BV30;  
 1/4" (6.3 mm); CrV 50BV30;  
 1/4" (6.3 mm); (155 mm); 72T; CrV 6140;  
 1/4" (6.3 mm); (150 mm); CrV 50BV30

YATO		
YT-1445	1/4" (6.3 mm)	10

GB Tool set  
D Sechskant-Steckschlüssel-Satz  
PL Zestaw narzędziowy  
RUS Набор инструмента  
CZ Sada nástrčných klíčů a ráčny  
H Dugókulcs készlet racsnis hajtókkal

RO Rotrusa chei tubulare cu antrenor  
F Coffret d'outillage  
I Set di utensili  
E Juego de herramientas  
CN 套筒扳手组套

BMC & COLOR SLEEVE  
XS SIZE



1/4"  
6.3mm

CrV  
50BV30

CrV  
6140

72T

AS-DRIVE

2



25  
PCS

- 1/4" (6.3 mm): 3.5, 4, 4.5, 5, 5.5, 6, 7, 8, 9, 10, 11, 12, 13, 14 mm (L=25 mm); CrV 50BV30;
- 1/4" (6.3 mm): 8, 10, 11, 12, 13 mm (L=50 mm); CrV 50BV30;
- 1/4" (6.3 mm): (50.8, 101.6 mm); CrV 50BV30;
- 1/4" (6.3 mm): CrV 50BV30;
- 1/4" (6.3 mm): (152.4 mm); CrV 50BV30;
- 1/4" (6.3 mm): (155 mm); 72T; CrV 6140;
- 1/4" (6.3 mm): (150 mm); CrV 50BV30

YATO		
YT-1446	1/4" (6.3 mm)	10



38  
PCS

CrV  
6150

S2

- 1/4" (6.3 mm): 3.5, 4, 4.5, 5, 5.5, 6, 7, 8, 9, 10, 11, 12, 13, 14 mm (L=25 mm); CrV 50BV30;
- 1/4" (6.3 mm): (50.8, 101.6 mm); CrV 50BV30;
- 1/4" (6.3 mm): (152.4 mm); CrV 50BV30;
- 1/4" (6.3 mm): (155 mm); 72T; CrV 6140;
- 1/4" (6.3 mm): (150 mm); CrV 50BV30;
- 1/4" (6.3 mm): PZ1, PZ2 (L=37 mm); AISI S2 / CrV 6150;
- 1/4" (6.3 mm): PH1, PH2 (L=37 mm); AISI S2 / CrV 6150;
- 1/4" (6.3 mm): PZ1, PZ2 (L=37 mm); AISI S2 / CrV 6150;
- 1/4" (6.3 mm): T10, T15, T20, T25, T30, T40 (L=37 mm); AISI S2 / CrV 6150;
- 1/4" (6.3 mm): 3, 4, 5, 6, 8 mm (L=37 mm); AISI S2 / CrV 6150

YATO		
YT-1447	1/4" (6.3 mm)	10



42  
PCS

CrV  
6150

S2

- 1/4" (6.3 mm): 4, 4.5, 5, 5.5, 6, 7, 8, 9, 10, 11, 12, 13, 14 mm (L=25 mm); CrV 50BV30;
- 1/4" (6.3 mm): 8, 9, 10, 11, 12, 13 mm (L=50 mm); CrV 50BV30;
- 1/4" (6.3 mm): (50.8, 101.6 mm); CrV 50BV30;
- 1/4" (6.3 mm): (150 mm); CrV 6140;
- 1/4" (6.3 mm): (152.4 mm); CrV 50BV30;
- 1/4" (6.3 mm): (155 mm); 72T; CrV 6140;
- 1/4" (6.3 mm): (150 mm); CrV 50BV30;
- 1/4" (6.3 mm) x 1/4" (6.3 mm); CrV 6140;
- 1/4" (6.3 mm): 3, 4, 5 mm (L=25 mm); AISI S2;
- 1/4" (6.3 mm): PH0, PH1, PH2 (L=25 mm); AISI S2;
- 1/4" (6.3 mm): PZ0, PZ1, PZ2 (L=25 mm); AISI S2;
- 1/4" (6.3 mm): 6, 7, 8 mm (L=25 mm); AISI S2;
- 1.5, 2, 2.5 mm; CrV 6150

YATO		
YT-1448	1/4" (6.3 mm)	6

GB Tool set  
 D Sechskant-Steckschlüssel-Satz  
 PL Zestaw narzędziowy  
 RUS Набор инструмента  
 CZ Sada nástrčných klíčů a ráčny  
 H Dugókulcs készlet racsnis hajtókarral

RO Rotrușă de chei tubulare cu antrenor  
 F Coffret d'outillage  
 I Set di utensili  
 E Juego de herramientas  
 CN 套筒扳手组套

BMC & COLOR SLEEVE  
 XS SIZE



56 PCS	1/4" 6.3mm	CrV 50BV30
	CrV 6150	CrV 6140
	S2	72T
		AS-DRIVE

2



1/4" (6.3 mm): 4, 4.5, 5, 5.5, 6, 7, 8, 9, 10, 11, 12, 13 mm (L=25 mm); CrV 50BV30;  
 1/4" (6.3 mm): 6, 7, 8, 9, 10, 11, 12, 13 mm (L=50 mm); CrV 50BV30; 1/4" (6.3 mm): E4, E5, E6, E7, E8, E10; CrV 50BV30; 1/4" (6.3 mm): (76, 152.4 mm); CrV 50BV30; 1/4" (6.3 mm): (150 mm); CrV 6140; 1/4" (6.3 mm); CrV 50BV30; 1/4" (6.3 mm): (152.4 mm); CrV 50BV30;  
 1/4" (6.3 mm): (155 mm); 72T; CrV 6140; 1/4" (6.3 mm): (150 mm); CrV 50BV30; 1/4" (6.3 mm) (F) x 3/8" (9.5 mm) (M); CrV 50BV30;  
 1/4" (6.3 mm): 4, 5, 5, 6.5 mm (L=37 mm); AISI S2 / CrV 6150; 1/4" (6.3 mm): PH1, PH2, PH3 (L=37 mm); AISI S2 / CrV 6150; 1/4" (6.3 mm): PZ1, PZ2, PZ3 (L=37 mm); AISI S2 / CrV 6150; 1/4" (6.3 mm): T8, T10, T15, T20, T25, T30, T40 (L=37 mm); AISI S2 / CrV 6150; 1/4" (6.3 mm): 3, 4, 5, 6, 7, 8 mm (L=37 mm); AISI S2 / CrV 6150

<b>YATO</b>		
YT-1450	1/4" (6.3 mm)	10

GB Socket set  
D Sechskant-Steckschlüssel-Satz  
PL Komplet nasadek dlugich  
RUS Набор насадок

CZ Sada nástrčných klíčů  
H Dugókulcs készlet  
RO Trusă chei tubulare  
F Set de douilles longues

I Serie di chiavi a bussola lunghi  
E Juego de herramientas  
CN 长套筒组套

9 PCS  
3/8" 10mm  
CrV 50BV30  
AS-DRIVE



3/8" (9.5 mm): 8, 10, 11, 12, 13, 14, 16, 17, 19 mm (L=63 mm); CrV 50BV30

PLASTIC HANGER



<b>YATO</b>	3/8" (9.5 mm)	10
YT-3855		

GB Tool set  
D Sechskant-Steckschlüssel-Satz  
PL Zestaw narzędziowy  
RUS Набор инструмента

CZ Sada nástrčných klíčů a ráčny  
H Dugókulcs készlet racsnis hajtókkal  
RO Rotrusa chei tubulare cu antrenor  
F Coffret d'outillage

I Set di utensili  
E Juego de herramientas  
CN 套筒扳手组套



METAL CASE & COLOR SLEEVE

3/8" 10mm  
CrV 50BV30  
CrV 6140

72T  
AS-DRIVE



15 PCS

3/8" (9.5 mm): 10, 11, 12, 13, 14, 15 (L=28 mm); 17, 19, 21, 22 mm (L=30 mm); CrV 50BV30;  
3/8" (9.5 mm): (76, 152.4 mm); CrV 50BV30;  
3/8" (9.5 mm): 16, 21 mm; CrV 50BV30;  
3/8" (9.5 mm): (200 mm); 72T; CrV 6140

<b>YATO</b>	3/8" (9.5 mm)	10
YT-38631		



19 PCS

3/8" (9.5 mm): 10, 11, 13, 14, 15 (L=28 mm); 17, 19 mm (L=30 mm); CrV 50BV30;  
3/8" (9.5 mm): 10, 11, 12, 13 mm (L=46 mm); 14, 15, 17, 19 mm (L=63 mm); CrV 50BV30;  
3/8" (9.5 mm): (76 mm); CrV 50BV30; 3/8" (9.5 mm); CrV 50BV30;  
3/8" (9.5 mm): (200 mm); 72T; CrV 6140;  
3/8" (9.5 mm): (215 mm); CrV 50BV30

<b>YATO</b>	3/8" (9.5 mm)	8
YT-38641		

GB Tool set  
D Sechskant-Steckschlüssel-Satz  
PL Zestaw narzędziowy  
RUS Набор инструмента  
CZ Sada nástrčných klíčů a ráčny  
H Dugókulcs készlet racsnis hajtókkal

RO Rotrusa chei tubulare cu antrenor  
F Coffret d'outillage  
I Set di utensili  
E Juego de herramientas  
CN 套筒扳手组套

BMC & COLOR SLEEVE  
XS SIZE



22 PCS  
3/8" 10mm  
CrV 50BV30

CrV 6140  
72T

AS-DRIVE



3/8" (9.5 mm): 6, 7, 8, 9, 10, 11, 12, 13, 14, 15, 16 mm (L=28 mm); 17, 18, 19, 20, 21, 22 mm (L=30 mm); CrV 50BV30;  
3/8" (9.5 mm): (76, 152.4 mm); CrV 50BV30;  
3/8" (9.5 mm); CrV 50BV30;  
3/8" (9.5 mm): (198 mm); CrV 50BV30;  
3/8" (9.5 mm): (200 mm); 72T; CrV 6140

<b>YATO</b>	3/8" (9.5 mm)	10
YT-3856		

GB Tool set  
 D Sechskant-Steckschlüssel-Satz  
 PL Zestaw narzędziowy  
 RUS Набор инструмента  
 CZ Sada nástrčných klíčů a ráčny  
 H Dugókulcs készlet racsnis hajtókarral

RO Rotrușa chei tubulare cu antrenor  
 F Coffret d'outillage  
 I Set di utensili  
 E Juego de herramientas  
 CN 套筒扳手组套













BMC & COLOR SLEEVE  
 M SIZE





58 PCS	3/8" 10mm	CrV 50BV30
CrV 6150	CrV 6140	
S2	72T	
AS-DRIVE		

2



 3/8" (9.5 mm): 6, 7, 8, 9, 10, 11, 12, 13, 14, 15, 16 mm (L=28 mm); 17, 18, 19, 20, 21, 22, 24 mm (L=30 mm); CrV 50BV30:  3/8" (9.5 mm): 8, 10, 11, 12, 13, 14, 15, 17, 19 mm (L=63 mm); CrV 50BV30:  3/8" (9.5 mm): (76, 254 mm); CrV 50BV30:  3/8" (9.5 mm); CrV 50BV30:  3/8" (9.5 mm): 16, 21 mm; CrV 50BV30:  3/8" (9.5 mm): (200 mm); 72T; CrV 6140:  1/2" (12.7 mm) (F) x 3/8" (9.5 mm) (M); CrV 50BV30:  3/8" (9.5 mm): 5.5, 6.5, 8 mm (L=50 mm); AISI S2 / CrV 6150:  3/8" (9.5 mm): PH1, PH2, PH3 (L=50 mm); AISI S2 / CrV 6150:  3/8" (9.5 mm): PZ1, PZ2 (L=50 mm); AISI S2 / CrV 6150:  3/8" (9.5 mm): T10, T15, T20, T25, T30, T40, T45, T50, T55 (L=50 mm); AISI S2 / CrV 6150:  3/8" (9.5 mm): 3, 4, 5, 6, 7, 8, 10 mm (L=50 mm); AISI S2 / CrV 6150

<b>YATO</b> 		
YT-3857	3/8" (9.5 mm)	6



GB Socket set  
 D Sechskant-Steckschlüssel-Satz  
 PL Komplet nasadek dlugich  
 RUS Набор насадок

CZ Sada nástrčných klíčů  
 H Dugókulcs készlet  
 RO Trusă chei tubulare  
 F Set de douilles longues

I Serie di chiavi a bussola lunghi  
 E Juego de herramientas  
 CN 长套筒组套

10 PCS  
 1/2" 12.5mm  
 CrV 50BV30  
 AS-DRIVE



1/2" (12.7 mm): 10, 12, 13, 14, 15, 17, 19, 21, 22, 24 mm (L=76 mm); CrV 50BV30

PLASTIC HANGER



<b>YATO</b>		
YT-3886	1/2" (12.7 mm)	10

GB Ratchet handle with socket set  
 D Sechskant-Steckschlüssel-Satz  
 PL Komplet nasadek z grzechotką  
 RUS Набор насадок

CZ Sada nástrčných klíčů a ráčny  
 H Dugókulcs készlet racsnis hajtókarral  
 RO Rotrusa chei tubulare cu antrenor  
 F Clé mixte à cliquet + douilles

I Serie di chiavi con cricchetto  
 E Matraca con boquillas  
 CN 套筒扳手组套

PLASTIC HANGER



12 PCS  
 1/2" 12.5mm  
 CrV 50BV30  
 CrV 6140  
 72T  
 AS-DRIVE



1/2" (12.7 mm): 10, 11, 12, 13, 14, 15, 17, 19, 21, 24 mm (L=38 mm); CrV 50BV30;  
 1/2" (12.7 mm): (127 mm); CrV 50BV30;  
 1/2" (12.7 mm); (255 mm); 72T; CrV 6140

<b>YATO</b>		
YT-3882	1/2" (12.7 mm)	10

GB Ratchet handle with socket set  
 D Sechskant-Steckschlüssel-Satz  
 PL Komplet nasadek z grzechotką  
 RUS Набор насадок

CZ Sada nástrčných klíčů a ráčny  
 H Dugókulcs készlet racsnis hajtókarral  
 RO Rotrusa chei tubulare cu antrenor  
 F Clé mixte à cliquet + douilles

I Serie di chiavi con cricchetto  
 E Matraca con boquillas  
 CN 套筒扳手组套

PLASTIC HANGER



19 PCS  
 1/2" 12.5mm  
 CrV 50BV30  
 CrV 6140  
 72T  
 AS-DRIVE



1/2" (12.7 mm): 8, 9, 10, 11, 12, 13, 14, 15, 16, 17, 19, 21, 22, 23, 24 mm (L=38 mm);  
 27, 30, 32 mm (L=42 mm); CrV 50BV30;  
 1/2" (12.7 mm); (255 mm); 72T; CrV 6140

<b>YATO</b>		
YT-3868	1/2" (12.7 mm)	6

GB Ratchet handle with socket set  
 D Sechskant-Steckschlüssel-Satz  
 PL Komplet nasadek z grzechotką  
 RUS Набор насадок

CZ Sada nástrčných klíčů a ráčny  
 H Dugókulcs készlet racsnis hajtókarral  
 RO Rotrusa chei tubulare cu antrenor  
 F Clé mixte à cliquet + douilles

I Serie di chiavi con cricchetto  
 E Matraca con boquillas  
 CN 套筒扳手组套

PLASTIC HANGER



19 PCS  
 1/2" 12.5mm  
 12 pt  
 CrV 50BV30  
 CrV 6140  
 72T  
 AS-DRIVE



1/2" (12.7 mm): 8, 9, 10, 11, 12, 13, 14, 15, 16, 17, 19, 21, 22, 23, 24 mm (L=38 mm);  
 27, 30, 32 mm (L=42 mm); CrV 50BV30;  
 1/2" (12.7 mm); (255 mm); 72T; CrV 6140

<b>YATO</b>		
YT-38682	1/2" (12.7 mm)	6

GB Tool set  
 D Sechskant-Steckschlüssel-Satz  
 PL Zestaw narzędziowy  
 RUS Набор инструмента

CZ Sada nástrčných klíčů a ráčny  
 H Dugókulcs készlet racsnis hajtókarral  
 RO Rotrusa chei tubulare cu antrenor  
 F Coffret d'outillage

I Set di utensili  
 E Juego de herramientas  
 CN 套筒扳手组套



METAL CASE & COLOR SLEEVE

1/2" 12.5mm  
 CrV 50BV30  
 CrV 6140  
 72T  
 AS-DRIVE



12 PCS

1/2" (12.7 mm): 10, 11, 12, 13, 14, 15, 17, 19, 21, 24 mm (L=38 mm); CrV 50BV30;  
 1/2" (12.7 mm): (125 mm); CrV 50BV30;  
 1/2" (12.7 mm); (250 mm); 72T; CrV 6140

<b>YATO</b>		
YT-12621	1/2" (12.7 mm)	8

GB Tool set  
D Sechskant-Steckschlüssel-Satz  
PL Zestaw narzędziowy  
RUS Набор инструмента

CZ Sada nástrčných klíčů a ráčny  
H Dugókulcs készlet racsnis hajtókarral  
RO Rotrușă chei tubulare cu antrenor  
F Coffret d'outillage

I Set di utensili  
E Juego de herramientas  
CN 套筒扳手套



METAL CASE & COLOR SLEEVE

1/2"  
12.5mm

CrV  
50BV30

CrV  
6140

72T

AS-DRIVE

2



18  
PCS

- 1/2" (12.7 mm): 11, 13, 14, 15, 17, 19, 21, 22, 23, 24 mm (L=38 mm); 27, 30, 32 mm (L=42 mm); CrV 50BV30;
- 1/2" (12.7 mm); (125 mm); CrV 50BV30;
- 1/2" (12.7 mm); 16, 21 mm; CrV 50BV30;
- 1/2" (12.7 mm); (250 mm); 72T; CrV 6140;
- 1/2" (12.7 mm); (460 mm); CrV 50BV30

<b>YATO</b>	○	
YT-12641	1/2" (12.7 mm)	3



23  
PCS

- 1/2" (12.7 mm): 10, 11, 12, 13, 14, 15, 16, 17, 18, 19, 20, 21, 22, 23, 24 mm (L=38 mm); 27, 30, 32 mm (L=42 mm); CrV 50BV30;
- 1/2" (12.7 mm); (125, 250 mm); CrV 50BV30;
- 1/2" (12.7 mm); CrV 50BV30;
- 1/2" (12.7 mm); (250 mm); CrV 50BV30;
- 1/2" (12.7 mm); (250 mm); 72T; CrV 6140

<b>YATO</b>	○	
YT-12651	1/2" (12.7 mm)	3



24  
PCS

- 1/2" (12.7 mm): 10, 11, 12, 13, 14, 15, 16, 17, 18, 19, 20, 21, 22, 23, 24 mm (L=38 mm); 27, 30, 32 mm (L=42 mm); CrV 50BV30;
- 1/2" (12.7 mm); (125 mm); CrV 50BV30; 1/2" (12.7 mm); CrV 50BV30;
- 1/2" (12.7 mm); 16, 21 mm; CrV 50BV30;
- 1/2" (12.7 mm); (250 mm); CrV 50BV30;
- 1/2" (12.7 mm); (250 mm); 72T; CrV 6140

<b>YATO</b>	○	
YT-12661	1/2" (12.7 mm)	3



25  
PCS

- 1/2" (12.7 mm): 10, 11, 12, 13, 14, 15, 16, 17, 18, 19, 20, 21, 22, 23, 24 mm (L=38 mm); 27, 30, 32 mm (L=42 mm); CrV 50BV30;
- 1/2" (12.7 mm); (50, 125 mm); CrV 50BV30;
- 1/2" (12.7 mm); 16, 21 mm; CrV 50BV30;
- 1/2" (12.7 mm); (250 mm); CrV 50BV30;
- 1/2" (12.7 mm); (250 mm); 72T; CrV 6140;
- 1/2" (12.7 mm); (317 mm); CrV 50BV30

<b>YATO</b>	○	
YT-12671	1/2" (12.7 mm)	3

GB Tool set  
D Sechskant-Steckschlüssel-Satz  
PL Zestaw narzędziowy  
RUS Набор инструмента

CZ Sada nástrčných klíčů a ráčny  
H Dugókulcs készlet racsnis hajtókarral  
RO Rotrușă chei tubulare cu antrenor  
F Coffret d'outillage

I Set di utensili  
E Juego de herramientas  
CN 套筒扳手套

1/2"  
12.5mm

CrV  
50BV30

CrV  
6140

72T

AS-DRIVE



12  
PCS

- 1/2" (12.7 mm): 10, 11, 12, 13, 14, 15, 17, 19, 21, 24 mm (L=38 mm); CrV 50BV30;
- 1/2" (12.7 mm); (127 mm); CrV 50BV30;
- 1/2" (12.7 mm); (255 mm); 72T; CrV 6140

BMC & COLOR SLEEVE  
XS SIZE



<b>YATO</b>	○	
YT-3867	1/2" (12.7 mm)	10

GB Tool set  
D Sechskant-Steckschlüssel-Satz  
PL Zestaw narzędziowy  
RUS Набор инструмента

CZ Sada nástrčných klíčů a ráčny  
H Dugókulcs készlet racsnis hajtókarral  
RO Rotruasa chei tubulare cu antrenor  
F Coffret d'outillage

I Set di utensili  
E Juego de herramientas  
CN 套筒扳手组套

1/2"  
12.5mm

CrV  
50BV30

CrV  
6140

72T

AS-DRIVE

2



18  
PCS

- 1/2" (12.7 mm): 11, 13, 14, 15, 17, 19, 21, 22, 23, 24 mm (L=38 mm); 27, 30, 32 mm (L=42 mm); CrV 50BV30;
- 1/2" (12.7 mm): (127 mm); CrV 50BV30;
- 1/2" (12.7 mm): 16, 21 mm; CrV 50BV30;
- 1/2" (12.7 mm): (255 mm); 72T; CrV 6140;
- 1/2" (12.7 mm): (457 mm); CrV 50BV30

BMC & COLOR SLEEVE  
S SIZE



YATO		
YT-3870	1/2" (12.7 mm)	6



20  
PCS

- 1/2" (12.7 mm): 10, 11, 12, 13, 14, 15, 16, 17, 18, 19, 22, 24 mm (L=38 mm); CrV 50BV30;
- 1/2" (12.7 mm): 13, 17, 19 mm (L=76 mm); CrV 50BV30;
- 1/2" (12.7 mm): (254 mm); CrV 50BV30;
- 3/8" (9.5 mm) (F) x 1/2" (12.7 mm) (M); CrV 50BV30;
- 1/2" (12.7 mm): CrV 50BV30;
- 1/2" (12.7 mm): 16 mm; CrV 50BV30;
- 1/2" (12.7 mm): (255 mm); 72T; CrV 6140

BMC & COLOR SLEEVE  
M SIZE



YATO		
YT-3869	1/2" (12.7 mm)	6



23  
PCS

- 1/2" (12.7 mm): 10, 11, 12, 13, 14, 15, 16, 17, 18, 19, 20, 21, 22, 23, 24 mm (L=38 mm); 27, 30, 32 mm (L=42 mm); CrV 50BV30;
- 1/2" (12.7 mm): (127, 254 mm); CrV 50BV30;
- 1/2" (12.7 mm); CrV 50BV30;
- 1/2" (12.7 mm): (255 mm); CrV 50BV30;
- 1/2" (12.7 mm): (255 mm); 72T; CrV 6140

BMC & COLOR SLEEVE  
M SIZE



YATO		
YT-3873	1/2" (12.7 mm)	6



24  
PCS

- 1/2" (12.7 mm): 10, 11, 12, 13, 14, 15, 16, 17, 18, 19, 20, 21, 22, 23, 24 mm (L=38 mm); 27, 30, 32 mm (L=42 mm); CrV 50BV30;
- 1/2" (12.7 mm): (127 mm); CrV 50BV30;
- 1/2" (12.7 mm); CrV 50BV30;
- 1/2" (12.7 mm): 16, 21 mm; CrV 50BV30;
- 1/2" (12.7 mm): (255 mm); CrV 50BV30;
- 1/2" (12.7 mm): (255 mm); 72T; CrV 6140

BMC & COLOR SLEEVE  
M SIZE



YATO		
YT-3872	1/2" (12.7 mm)	6

GB Tool set  
 D Sechskant-Steckschlüssel-Satz  
 PL Zestaw narzędziowy  
 RUS Набор инструмента

CZ Sada nástrčných klíčů a ráčny  
 H Dugókulcs készlet racsnis hajtókarral  
 RO Rotrusa chei tubulare cu antrenor  
 F Coffret d'outillage

I Set di utensili  
 E Juego de herramientas  
 CN 套筒扳手套

1/2"  
12.5mm  
CrV  
50BV30  
CrV  
6140  
72T  
AS-DRIVE

2



25  
PCS

- 1/2" (12.7 mm): 8, 9, 10, 11, 12, 13, 14, 15, 16, 17, 18, 19, 20, 21, 22, 23, 24 mm (L=38 mm); 27, 30, 32 mm (L=42 mm); CrV 50BV30;
- 1/2" (12.7 mm): (127, 254 mm); CrV 50BV30;
- 3/8" (9.5 mm) (F) x 1/2" (12.7 mm) (M); CrV 50BV30;
- 1/2" (12.7 mm); CrV 50BV30;
- 1/2" (12.7 mm); (255 mm); 72T; CrV 6140

BMC & COLOR SLEEVE  
M SIZE



<b>YATO</b>		
YT-3871	1/2" (12.7 mm)	6



25  
PCS

- 1/2" (12.7 mm): 10, 11, 12, 13, 14, 15, 16, 17, 18, 19, 20, 21, 22, 23, 24 mm (L=38 mm); 27, 30, 32 mm (L=42 mm); CrV 50BV30;
- 1/2" (12.7 mm): (127 mm); CrV 50BV30;
- 1/2" (12.7 mm): 16, 21 mm; CrV 50BV30;
- 1/2" (12.7 mm); (255 mm); CrV 50BV30;
- 1/2" (12.7 mm); (255 mm); 72T; CrV 6140;
- 1/2" (12.7 mm); (317 mm); CrV 50BV30;
- 1/2" (12.7 mm) (F) x 3/8" (9.5 mm) (M); CrV 50BV30

BMC & COLOR SLEEVE  
L SIZE



<b>YATO</b>		
YT-3874	1/2" (12.7 mm)	6



38  
PCS

- 1/2" (12.7 mm): 10, 11, 12, 13, 14, 15, 16, 17, 18, 19, 20, 21, 22, 23, 24 mm (L=38 mm); 27, 30, 32 mm (L=42 mm); CrV 50BV30;
- 1/2" (12.7 mm): 10, 13, 17, 19 mm (L=76 mm); CrV 50BV30;
- 1/2" (12.7 mm): (127, 254 mm); CrV 50BV30;
- 1/2" (12.7 mm); CrV 50BV30;
- 1/2" (12.7 mm): 16, 21 mm; CrV 50BV30;
- 1/2" (12.7 mm); (255 mm); CrV 50BV30;
- 1/2" (12.7 mm); (255 mm); 72T; CrV 6140;
- 8, 10, 11, 12, 13, 14, 17, 19, 22 mm; CrV

BMC & COLOR SLEEVE  
M SIZE



<b>YATO</b>		
YT-3876	1/2" (12.7 mm)	6

GB Tool set  
D Sechskant-Steckschlüssel-Satz  
PL Zestaw narzędziowy  
RUS Набор инструмента

CZ Sada nástrčných klíčů a ráčny  
H Dugókulcs készlet racsnis hajtókarral  
RO Rotruasa chei tubulare cu antrenor  
F Coffret d'outillage

I Set di utensili  
E Juego de herramientas  
CN 套筒扳手组套

BMC & COLOR SLEEVE  
M SIZE



46 PCS	1/2" 12.5mm
METRIC & S.A.E.	CrV 50BV30
CrV 6140	72T
AS-DRIVE	



1/2" (12.7 mm): 8, 9, 10, 11, 12, 13, 14, 15, 16, 17, 18, 19, 20, 21, 22, 23, 24 mm (L=38 mm); 27, 30, 32 mm (L=42 mm); CrV 50BV30: 1/2" (12.7 mm): 10, 12, 13, 14, 15, 17, 19 mm (L=76 mm); CrV 50BV30: 1/2" (12.7 mm) x 3/8" (9.5 mm), 1/2" (12.7 mm) x 7/16" (11.1 mm), 1/2" (12.7 mm) x 1/2" (12.7 mm), 1/2" (12.7 mm) x 9/16" (14.3 mm), 1/2" (12.7 mm) x 5/8" (15.9 mm), 1/2" (12.7 mm) x 11/16" (17.5 mm), 1/2" (12.7 mm) x 3/4" (19.0 mm), 1/2" (12.7 mm) x 13/16" (20.6 mm), 1/2" (12.7 mm) x 7/8" (22.2 mm), 1/2" (12.7 mm) x 15/16" (23.8 mm), 1/2" (12.7 mm) x 1" (25.4 mm); CrV 50BV30: 1/2" (12.7 mm): (127, 254 mm); CrV 50BV30: 3/8" (9.5 mm) (F) x 1/2" (12.7 mm) (M); CrV 50BV30: 1/2" (12.7 mm); CrV 50BV30: 1/2" (12.7 mm): 16, 21 mm; CrV 50BV30: 1/2" (12.7 mm); (255 mm); 72T: CrV 6140: 1/2" (12.7 mm); (250 mm); CrV 50BV30

YATO	1/2" (12.7 mm)	6
YT-3877		

GB Tool set  
D Sechskant-Steckschlüssel-Satz  
PL Zestaw narzędziowy  
RUS Набор инструмента

CZ Sada nástrčných klíčů a ráčny  
H Dugókulcs készlet racsnis hajtókarral  
RO Rotruasa chei tubulare cu antrenor  
F Coffret d'outillage

I Set di utensili  
E Juego de herramientas  
CN 套筒扳手组套

BMC & COLOR SLEEVE  
M SIZE



72 PCS	1/2" 12.5mm	1/4" 6.3mm
CrV 50BV30	CrV 6140	
72T	AS-DRIVE	



1/2" (12.7 mm): 10, 11, 12, 13, 14, 15, 16, 17, 18, 19, 20, 21, 22, 23, 24 mm (L=38 mm); 27 mm (L=42 mm), 1/4" (6.3 mm): 4, 5, 6, 7, 8, 9, 10, 11, 12, 13 mm (L=25 mm); CrV 50BV30: 1/2" (12.7 mm): (127, 254 mm), 1/4" (6.3 mm): (152.4 mm); CrV 50BV30: 3/8" (9.5 mm) (F) x 1/2" (12.7 mm) (M); CrV 50BV30: 1/2" (12.7 mm); CrV 50BV30: 1/2" (12.7 mm): 21 mm; CrV 50BV30: 1/2" (12.7 mm): (255 mm), 1/4" (6.3 mm): (155 mm); 72T: CrV 6140: 1/4" (6.3 mm); (150 mm); CrV 50BV30: 1/4" (6.3 mm) x 1/4" (6.3 mm); CrV 6140: 1/4" (6.3 mm): 4, 5, 5.5, 6, 7 mm (L=25 mm); CrV 6150: 1/4" (6.3 mm): PH0, PH1, PH2, PH3 (L=25 mm); CrV 6150: 1/4" (6.3 mm): PZ0, PZ1, PZ2, PZ3 (L=25 mm); CrV 6150: 1/4" (6.3 mm): T8, T9, T10, T15, T20, T25, T27, T30, T40 (L=25 mm); CrV 6150: 1/4" (6.3 mm): 3, 4, 5, 6, 7, 8 mm (L=25 mm); CrV 6150: 1/4" (6.3 mm): S0, S1, S2, S3 (L=25 mm); CrV 6150: 1.25, 1.5, 2.5, 3 mm; CrV 6150

YATO	1/2" (12.7 mm)	1/4" (6.3 mm)	4
YT-38782			

GB Tool set  
 D Sechskant-Steckschlüssel-Satz  
 PL Zestaw narzędziowy  
 RUS Набор инструмента

CZ Sada nástrčných klíčů a ráčny  
 H Dugókulcs készlet racsnis hajtókarral  
 RO Rotrusa chei tubulare cu antrenor  
 F Coffret d'outillage

I Set di utensili  
 E Juego de herramientas  
 CN 套筒扳手组套

1/2" 12.5mm  
 CrV 50BV30  
 S2  
 1/4" 6.3mm  
 CrV 6140  
 72T  
 AS-DRIVE

2



BMC & COLOR SLEEVE L SIZE



77 PCS  
 CrV 6150

1/2" (12.7 mm): 10, 11, 12, 13, 14, 15, 17, 19, 22, 24 mm (L=38 mm); 27, 30, 32 mm (L=42 mm), 1/4" (6.3 mm): 4, 5, 6, 7, 8, 9, 10, 11, 12 mm (L=25 mm); CrV 50BV30: 1/2" (12.7 mm): (127, 254 mm), 1/4" (6.3 mm): (76, 101.6 mm); CrV 50BV30: 1/2" (12.7 mm), 1/4" (6.3 mm); CrV 50BV30: 1/2" (12.7 mm): 16, 21 mm; CrV 50BV30: 1/2" (12.7 mm); (255 mm), 1/4" (6.3 mm); (155 mm); 72T; CrV 6140: 1/4" (6.3 mm) x 1/4" (6.3 mm); CrV 6140: 1/4" (6.3 mm) x 1/4" (6.3 mm) (L=25 mm); CrV 6140: 1/4" (6.3 mm): 3, 4, 5.5, 7 mm (L=25 mm); AISI S2: 1/4" (6.3 mm): PH0, PH1, PH2, PH3 (L=25 mm); AISI S2: 1/4" (6.3 mm): PZ1, PZ3 (L=25 mm); AISI S2: 1/4" (6.3 mm): T10, T15, T20, T25, T30 (L=25 mm); AISI S2: 1/4" (6.3 mm): 2, 3, 4, 5, 6 mm (L=25 mm); AISI S2: 7, 8, 9, 10, 11, 12, 13, 14, 15, 17, 19 mm; CrV: 8x9, 10x11, 12x13, 14x15 mm; CrV 6140: 1.5, 2, 2.5, 5, 6, 8, 10 mm; CrV 6150

YATO	1/2" (12.7 mm)	1/4" (6.3 mm)	2
YT-3878			



BMC & COLOR SLEEVE XXXL SIZE



79 PCS  
 CrV 60  
 CrV 55

CrMo  
 SVC55  
 SK5

1/2" (12.7 mm): 10, 11, 12, 13, 14, 16, 17, 19, 22, 24, 26 mm (L=38 mm); 27, 30, 32 mm (L=42 mm), 1/4" (6.3 mm): 5, 6, 7, 8, 9, 10, 11, 12, 13 mm (L=25 mm); CrV 50BV30: 1/2" (12.7 mm): 10, 11, 12, 13, 14, 17, 19 mm (L=76 mm); CrV 50BV30: 1/2" (12.7 mm): (127 mm), 1/4" (6.3 mm): (50.8 mm); CrV 50BV30: 1/2" (12.7 mm); CrV 50BV30: 1/2" (12.7 mm): 16, 21 mm; CrV 50BV30: 1/2" (12.7 mm); (255 mm), 1/4" (6.3 mm); (155 mm); 72T; CrV 6140: 1/4" (6.3 mm): (150 mm); CrV 50BV30: 1/2" (12.7 mm): (420 mm); CrV 50BV30: 6, 7, 8, 9, 10, 11, 12, 13, 14, 16, 17, 19, 22, 24 mm; CrV: 2.0x40, 2.4x75 mm; S2: 3.0x75, 4.0x100, 6.5x150, 8.0x150 mm; SVC55: PH0x75 mm; S2: PH1x75, PH2x100 mm; SVC55: 180 mm; CrV 55: 160 mm; CrV 55: 160, 200 mm; CrV 55: 250 mm; CrV: 300 g; 300 mm; 180 mm; CrMo: 120 mm; CrV 60: SK5; 2.5, 3, 4, 5, 6, 8, 10 mm; CrV

YATO	1/2" (12.7 mm)	1/4" (6.3 mm)	2
YT-3891			

GB Tool set  
D Sechskant-Steckschlüssel-Satz  
PL Zestaw narzędziowy  
RUS Набор инструмента

CZ Sada nástrčných klíčů a ráčny  
H Dugókulcs készlet racsnis hajtókarral  
RO Rotruşa chei tubulare cu antrenor  
F Coffret d'outillage

I Set di utensili  
E Juego de herramientas  
CN 套筒扳手组套

BMC & COLOR SLEEVE  
L SIZE



1/2" 12.5mm	1/4" 6.3mm
CrV 50BV30	CrV 6150
CrV 6140	S2
72T	AS-DRIVE

2



**82**  
PCS

1/2" (12.7 mm): 14, 15, 16, 17, 18, 19, 20, 22, 24 mm (L=38 mm); 27, 30, 32 mm (L=42 mm), 1/4" (6.3 mm): 4, 4.5, 5, 5.5, 6, 7, 8, 9, 10, 11, 12, 13, 14 mm (L=25 mm); CrV 50BV30: 1/2" (12.7 mm): (127, 254 mm), 1/4" (6.3 mm): (50.8, 101.6 mm); CrV 50BV30: 3/8" (9.5 mm) (F) x 1/2" (12.7 mm) (M); CrV 50BV30: 1/4" (6.3 mm): (150 mm); CrV 6140: 1/2" (12.7 mm), 1/4" (6.3 mm); CrV 50BV30: 1/2" (12.7 mm): 16, 21 mm; CrV 50BV30: 1/4" (6.3 mm): (152.4 mm); CrV 50BV30: 1/2" (12.7 mm): (255 mm), 1/4" (6.3 mm): (155 mm); 72T: CrV 6140: 1/4" (6.3 mm): (150 mm); CrV 50BV30: 1/2" (12.7 mm) x 5/16" (7.9 mm); CrV 6140: 1/4" (6.3 mm) x 1/4" (6.3 mm); CrV 6140: 5/16" (7.9 mm): 8, 10, 12 mm (L=30 mm); AISI S2: 5/16" (7.9 mm): PH3, PH4 (L=30 mm); AISI S2: 5/16" (7.9 mm): PZ3, PZ4 (L=30 mm); AISI S2: 5/16" (7.9 mm): T40, T45, T50, T55 (L=30 mm); AISI S2: 5/16" (7.9 mm): 8, 10, 12, 14 mm (L=30 mm); AISI S2: 1/4" (6.3 mm): 4, 5.5, 7 mm (L=37 mm); AISI S2 / CrV 6150: 1/4" (6.3 mm): PH1, PH2 (L=37 mm); AISI S2 / CrV 6150: 1/4" (6.3 mm): PZ1, PZ2 (L=37 mm); AISI S2 / CrV 6150: 1/4" (6.3 mm): T8, T10, T15, T20, T25, T30 (L=37 mm); AISI S2 / CrV 6150: 1/4" (6.3 mm): 3, 4, 5, 6 mm (L=37 mm); AISI S2 / CrV 6150: 8, 10, 11, 12, 13, 14, 17, 19, 22 mm; CrV

YATO	1/2" (12.7 mm)	1/4" (6.3 mm)	4
YT-1269	1/2" (12.7 mm)	1/4" (6.3 mm)	4



**94**  
PCS

1/2" (12.7 mm): 10, 11, 12, 13, 14, 15, 16, 17, 18, 19, 20, 21, 22, 23, 24 mm (L=38 mm); 27, 30, 32 mm (L=42 mm), 1/4" (6.3 mm): 4, 4.5, 5, 5.5, 6, 7, 8, 9, 10, 11, 12, 13, 14 mm (L=25 mm); CrV 50BV30: 1/2" (12.7 mm): 14, 15, 17, 19 mm (L=76 mm), 1/4" (6.3 mm): 6, 7, 8, 9, 10, 11, 12, 13 mm (L=50 mm); CrV 50BV30: 1/2" (12.7 mm): (127, 254 mm), 1/4" (6.3 mm): (50.8, 101.6 mm); CrV 50BV30: 3/8" (9.5 mm) (F) x 1/2" (12.7 mm) (M); CrV 50BV30: 1/4" (6.3 mm): (150 mm); CrV 6140: 1/2" (12.7 mm), 1/4" (6.3 mm); CrV 50BV30: 1/2" (12.7 mm): 16, 21 mm; CrV 50BV30: 1/4" (6.3 mm): (152.4 mm); CrV 50BV30: 1/2" (12.7 mm): (255 mm), 1/4" (6.3 mm): (155 mm); 72T: CrV 6140: 1/4" (6.3 mm): (150 mm); CrV 50BV30: 1/2" (12.7 mm) x 5/16" (7.9 mm); CrV 6140: 1/4" (6.3 mm) x 1/4" (6.3 mm) (L=25 mm); CrV 6140: 5/16" (7.9 mm): 8, 10, 12 mm (L=30 mm); AISI S2: 5/16" (7.9 mm): PH3, PH4 (L=30 mm); AISI S2: 5/16" (7.9 mm): PZ3, PZ4 (L=30 mm); AISI S2: 5/16" (7.9 mm): T40, T45, T50, T55 (L=30 mm); AISI S2: 5/16" (7.9 mm): 8, 10, 12, 14 mm (L=30 mm); AISI S2: 1/4" (6.3 mm): 4, 5.5, 7 mm (L=37 mm); AISI S2 / CrV 6150: 1/4" (6.3 mm): PH1, PH2 (L=37 mm); AISI S2 / CrV 6150: 1/4" (6.3 mm): PZ1, PZ2 (L=37 mm); AISI S2 / CrV 6150: 1/4" (6.3 mm): T8, T10, T15, T20, T25, T30 (L=37 mm); AISI S2 / CrV 6150: 1/4" (6.3 mm): 3, 4, 5, 6 mm (L=37 mm); AISI S2 / CrV 6150: 1.5, 2.0, 2.5 mm; CrV 6150

YATO	1/2" (12.7 mm)	1/4" (6.3 mm)	4
YT-1268	1/2" (12.7 mm)	1/4" (6.3 mm)	4

GB Tool set  
 D Sechskant-Steckschlüssel-Satz  
 PL Zestaw narzędziowy  
 RUS Набор инструмента

CZ Sada nástrčných klíčů a ráčny  
 H Dugókulcs készlet racsnis hajtókarral  
 RO Rotrusa chei tubulare cu antrenor  
 F Coffret d'outillage

I Set di utensili  
 E Juego de herramientas  
 CN 套筒扳手套

BMC & COLOR SLEEVE  
 L SIZE



1/2" 12.5mm	1/4" 6.3mm
CrV 50BV30	CrV 6150
CrV 6140	S2
72T	AS-DRIVE

2



94  
PCS

12pt

1/2" (12.7 mm): 10, 11, 12, 13, 14, 15, 16, 17, 18, 19, 20, 21, 22, 23, 24 mm (L=38 mm); 27, 30, 32 mm (L=42 mm), 1/4" (6.3 mm): 4, 4.5, 5, 5.5, 6, 7, 8, 9, 10, 11, 12, 13, 14 mm (L=25 mm); CrV 50BV30: 1/2" (12.7 mm): 14, 15, 17, 19 mm (L=76 mm), 1/4" (6.3 mm): 6, 7, 8, 9, 10, 11, 12, 13 mm (L=50 mm); CrV 50BV30: 1/2" (12.7 mm): (127, 254 mm), 1/4" (6.3 mm): (50.8, 101.6 mm); CrV 50BV30: 3/8" (9.5 mm) (F) x 1/2" (12.7 mm) (M); CrV 50BV30: 1/4" (6.3 mm): (150 mm); CrV 6140: 1/2" (12.7 mm), 1/4" (6.3 mm); CrV 50BV30: 1/2" (12.7 mm): 16, 21 mm; CrV 50BV30: 1/4" (6.3 mm): (152.4 mm); CrV 50BV30: 1/2" (12.7 mm): (255 mm), 1/4" (6.3 mm): (155 mm); 72T; CrV 6140: 1/4" (6.3 mm): (150 mm); CrV 50BV30: 1/2" (12.7 mm) x 5/16" (7.9 mm); CrV 6140: 1/4" (6.3 mm) x 1/4" (6.3 mm) (L=25 mm); CrV 6140: 5/16" (7.9 mm): 8, 10, 12 mm (L=30 mm); AISI S2: 5/16" (7.9 mm): PH3, PH4 (L=30 mm); AISI S2: 5/16" (7.9 mm): PZ3, PZ4 (L=30 mm); AISI S2: 5/16" (7.9 mm): T40, T45, T50, T55 (L=30 mm); AISI S2: 5/16" (7.9 mm): 8, 10, 12, 14 mm (L=30 mm); AISI S2: 1/4" (6.3 mm): 4, 5.5, 7 mm (L=37 mm); AISI S2 / CrV 6150: 1/4" (6.3 mm): PH1, PH2 (L=37 mm); AISI S2 / CrV 6150: 1/4" (6.3 mm): PZ1, PZ2 (L=37 mm); AISI S2 / CrV 6150: 1/4" (6.3 mm): T8, T10, T15, T20, T25, T30 (L=37 mm); AISI S2 / CrV 6150: 1/4" (6.3 mm): 3, 4, 5, 6 mm (L=37 mm); AISI S2 / CrV 6150: 1.5, 2.0, 2.5 mm; CrV 6150

YATO	1/2" (12.7 mm)	1/4" (6.3 mm)	4
YT-12682			



108  
PCS

1/2" (12.7 mm): 10, 11, 12, 13, 14, 15, 16, 17, 18, 19, 20, 21, 22, 24 mm (L=38 mm); 27, 30, 32 mm (L=42 mm), 1/4" (6.3 mm): 4, 4.5, 5, 5.5, 6, 7, 8, 9, 10, 11, 12, 13, 14 mm (L=25 mm); CrV 50BV30: 1/2" (12.7 mm): 14, 15, 17, 19, 22 mm (L=76 mm), 1/4" (6.3 mm): 6, 7, 8, 9, 10, 11, 12, 13 mm (L=50 mm); CrV 50BV30: 1/2" (12.7 mm): E10, E11, E12, E14, E16, E18, E20, E24, 1/4" (6.3 mm): E4, E5, E6, E7, E8; CrV 50BV30: 1/2" (12.7 mm): (127, 254 mm), 1/4" (6.3 mm): (50.8, 101.6 mm); CrV 50BV30: 3/8" (9.5 mm) (F) x 1/2" (12.7 mm) (M); CrV 50BV30: 1/2" (12.7 mm), 1/4" (6.3 mm); CrV 50BV30: 1/2" (12.7 mm): 16, 21 mm; CrV 50BV30: 1/4" (6.3 mm): (152.4 mm); CrV 50BV30: 1/2" (12.7 mm): (255 mm), 1/4" (6.3 mm): (155 mm); 72T; CrV 6140: 1/4" (6.3 mm): (150 mm); CrV 50BV30: 1/2" (12.7 mm) x 5/16" (7.9 mm); CrV 6140: 5/16" (7.9 mm): 8, 10, 12 mm (L=30 mm); AISI S2: 5/16" (7.9 mm): PH3, PH4 (L=30 mm); AISI S2: 5/16" (7.9 mm): PZ3, PZ4 (L=30 mm); AISI S2: 5/16" (7.9 mm): T40, T45, T50, T55, T60 (L=30 mm); AISI S2: 5/16" (7.9 mm): 7, 8, 10, 12, 14 mm (L=30 mm); AISI S2: 1/4" (6.3 mm): 4, 5.5, 6.5 mm (L=37 mm); AISI S2 / CrV 6150: 1/4" (6.3 mm): PH1, PH2 (L=37 mm); AISI S2 / CrV 6150: 1/4" (6.3 mm): PZ1, PZ2 (L=37 mm); AISI S2 / CrV 6150: 1/4" (6.3 mm): T8, T10, T15, T20, T25, T27, T30 (L=37 mm); AISI S2 / CrV 6150: 1/4" (6.3 mm): 3, 4, 5, 6 mm (L=37 mm); AISI S2 / CrV 6150: 1.5, 2.0, 2.5 mm; CrV 6150

YATO	1/2" (12.7 mm)	1/4" (6.3 mm)	2
YT-3879			



GB Tool set  
 D Sechskant-Steckschlüssel-Satz  
 PL Zestaw narzędziowy  
 RUS Набор инструмента

CZ Sada nástrčných klíčů a ráčny  
 H Dugókulcs készlet racsnis hajtókarral  
 RO Roturusa chei tubulare cu antrenor  
 F Coffret d'outillage

I Set di utensili  
 E Juego de herramientas  
 CN 套筒扳手组套

BMC & COLOR SLEEVE  
 XXL SIZE



1/2" 12.5mm	1/4" 6.3mm
CrV 50BV30	CrV 6150
CrV 6140	CrV 55
SVC 55	S2
72T	AS-DRIVE

2



**109**  
PCS

1/2" (12.7 mm): 12, 13, 14, 15, 16, 17, 18, 19, 20, 21, 22, 24 mm (L=38 mm); 27, 30, 32 mm (L=42 mm), 1/4" (6.3 mm): 4, 4.5, 5, 5.5, 6, 7, 8, 9, 10, 11, 12, 13, 14 mm (L=25 mm); CrV 50BV30: 1/2" (12.7 mm): 10, 12, 13, 14, 17, 19 mm (L=76 mm), 1/4" (6.3 mm): 4, 5, 6, 7, 8, 9 mm (L=50 mm); CrV 50BV30: 1/2" (12.7 mm): E10, E12, E14, E16, E18, E20, E22, E24; CrV 50BV30: 1/2" (12.7 mm): (254 mm), 1/4" (6.3 mm): (152.4 mm); CrV 50BV30: 3/8" (9.5 mm) (F) x 1/2" (12.7 mm) (M), 3/8" (9.5 mm) (F) x 1/4" (6.3 mm) (M); CrV 50BV30: 1/2" (12.7 mm), 1/4" (6.3 mm); CrV 50BV30: 1/2" (12.7 mm): 16, 21 mm; CrV 50BV30: 1/2" (12.7 mm): (255 mm), 1/4" (6.3 mm): (155 mm); 72T; CrV 6140: 1/4" (6.3 mm): (150 mm); CrV 50BV30: 1/4" (6.3 mm): 4.0, 5.5, 6.5 mm (L=37 mm); AISI S2 / CrV 6150: 1/4" (6.3 mm): PH1, PH2, PH3 (L=37 mm); AISI S2 / CrV 6150: 1/4" (6.3 mm): PZ2, PZ3 (L=37 mm); AISI S2 / CrV 6150: 1/4" (6.3 mm): T8, T10, T15, T20, T25 (L=37 mm); AISI S2 / CrV 6150: 1/4" (6.3 mm): T10, T15, T20, T25, T40 (L=37 mm); AISI S2 / CrV 6150: 1/4" (6.3 mm): 3, 4, 5, 6 mm (L=37 mm); AISI S2 / CrV 6150: 8, 9, 10, 11, 12, 13, 14, 15, 16, 17, 18, 19 mm; CrV: 8x9, 10x11, 12x13, 14x15 mm; CrV 6140: 8x10, 12x13, 17x19 mm; CrV 6140: 3x75, 4x100, 6.5x150, PH1x75, PH2x100, PH3x150 mm; SVC55: 180 mm; CrV 55: 160 mm; CrV 55: 300 g

YATO	1/2" (12.7 mm)	1/4" (6.3 mm)	2
YT-3889			



**122**  
PCS

1/2" (12.7 mm): 12, 13, 14, 15, 16, 17, 18, 19, 20, 21, 22, 24 mm (L=38 mm); 27, 30, 32 mm (L=42 mm), 1/4" (6.3 mm): 4, 4.5, 5, 5.5, 6, 7, 8, 9, 10, 11, 12, 13, 14 mm (L=25 mm); CrV 50BV30: 1/2" (12.7 mm): 10, 12, 13, 14, 17, 19 mm (L=76 mm), 1/4" (6.3 mm): 4, 5, 6, 7, 8, 9 mm (L=50 mm); CrV 50BV30: 1/2" (12.7 mm): E10, E12, E14, E16, E18, E20, E22, E24; CrV 50BV30: 1/2" (12.7 mm): (254 mm), 1/4" (6.3 mm): (152.4 mm); CrV 50BV30: 3/8" (9.5 mm) (F) x 1/2" (12.7 mm) (M), 3/8" (9.5 mm) (F) x 1/4" (6.3 mm) (M); CrV 50BV30: 1/2" (12.7 mm), 1/4" (6.3 mm); CrV 50BV30: 1/2" (12.7 mm): 16, 21 mm; CrV 50BV30: 1/2" (12.7 mm): (255 mm), 1/4" (6.3 mm): (155 mm); 72T; CrV 6140: 1/4" (6.3 mm): (150 mm); CrV 50BV30: 1/4" (6.3 mm) x 1/4" (6.3 mm); CrV 6140: 1/4" (6.3 mm): 3, 4, 5, 6 mm (L=25 mm); AISI S2: 1/4" (6.3 mm): PH0, PH1, PH2 (L=25 mm); AISI S2: 1/4" (6.3 mm): PZ0, PZ1, PZ2 (L=25 mm); AISI S2: 1/4" (6.3 mm): 4.0, 5.5, 6.5 mm (L=37 mm); AISI S2 / CrV 6150: 1/4" (6.3 mm): PH1, PH2, PH3 (L=37 mm); AISI S2 / CrV 6150: 1/4" (6.3 mm): PZ2, PZ3 (L=37 mm); AISI S2 / CrV 6150: 1/4" (6.3 mm): T8, T10, T15, T20, T25 (L=37 mm); AISI S2 / CrV 6150: 1/4" (6.3 mm): T10, T15, T20, T25, T40 (L=37 mm); AISI S2 / CrV 6150: 1/4" (6.3 mm): 3, 4, 5, 6 mm (L=37 mm); AISI S2 / CrV 6150: 8, 9, 10, 11, 12, 13, 14, 15, 16, 17, 18, 19 mm; CrV: 4x100, 6.5x150, PH2x100, PH3x150 mm; SVC55: 180 mm; CrV 55: 160 mm; CrV 55: 160 mm; CrV 55: 300 g; 2, 2.5, 3, 4, 5, 6, 7, 8, 10 mm; CrV 6150

YATO	1/2" (12.7 mm)	1/4" (6.3 mm)	2
YT-3890			

GB Tool set  
D Sechskant-Steckschlüssel-Satz  
PL Zestaw narzędziowy  
RUS Набор инструмента

CZ Sada nástrčných klíčů a ráčny  
H Dugókulcs készlet racsnis hajtókarral  
RO Rotrusa chei tubulare cu antrenor  
F Coffret d'outillage

I Set di utensili  
E Juego de herramientas  
CN 套筒扳手组套

BMC & COLOR SLEEVE  
XL SIZE



1/2"	3/8"	1/4"
12.5mm	10mm	6.3mm
CrV 50BV30	CrV 6150	CrV 6140
S2	72T	AS-DRIVE

2



111  
PCS

1/2" (12.7 mm): 14, 15, 16, 17, 18, 19, 20, 21, 22, 23, 24 mm (L=38 mm); 27, 30, 32 mm (L=42 mm); 3/8" (9.5 mm): 9, 10, 11, 12, 13, 14, 15, 16 mm (L=28 mm); 17, 18, 19 mm (L=30 mm); 1/4" (6.3 mm): 3.5, 4, 4.5, 5, 5.5, 6, 7, 8, 9, 10, 11, 12, 13 mm (L=25 mm); CrV 50BV30: 1/2" (12.7 mm): (127, 254 mm); 3/8" (9.5 mm): (76, 152.4 mm); 1/4" (6.3 mm): (50.8, 152.4 mm); CrV 50BV30: 3/8" (9.5 mm) (F) x 1/2" (12.7 mm) (M), 1/2" (12.7 mm) (F) x 3/8" (9.5 mm) (M), 3/8" (9.5 mm) (F) x 1/4" (6.3 mm) (M); CrV 50BV30: 1/2" (12.7 mm); 3/8" (9.5 mm); 1/4" (6.3 mm); CrV 50BV30: 1/2" (12.7 mm): 16, 21 mm; 3/8" (9.5 mm): 16, 21 mm; CrV 50BV30: 1/2" (12.7 mm); (255 mm); 3/8" (9.5 mm): 200 mm; 1/4" (6.3 mm): (155 mm); 72T: CrV 6140: 1/4" (6.3 mm): (150 mm); CrV 50BV30: 1/2" (12.7 mm) x 5/16" (7.9 mm); 3/8" (9.5 mm) x 5/16" (7.9 mm); CrV 6140: 5/16" (7.9 mm): 6, 6.5, 8 mm (L=30 mm); AISI S2: 5/16" (7.9 mm): PH2, PH3 (L=30 mm); AISI S2: 5/16" (7.9 mm): PZ2, PZ3 (L=30 mm); AISI S2: 5/16" (7.9 mm): T27, T30, T35, T40, T45 (L=30 mm); AISI S2: 5/16" (7.9 mm): 5.5, 6, 6.5 mm (L=30 mm); AISI S2: 1/4" (6.3 mm): 4, 5.5, 6.5 mm (L=37 mm); AISI S2 / CrV 6150: 1/4" (6.3 mm): PH1, PH2 (L=37 mm); AISI S2 / CrV 6150: 1/4" (6.3 mm): PZ1, PZ2 (L=37 mm); AISI S2 / CrV 6150: 1/4" (6.3 mm): T8, T10, T15, T20, T25 (L=37 mm); AISI S2 / CrV 6150: 1/4" (6.3 mm): T10, T15, T20, T25, T40 (L=37 mm); AISI S2 / CrV 6150: 1/4" (6.3 mm): 3, 4, 5, 6 mm (L=37 mm); AISI S2 / CrV 6150: 8, 9, 10, 11, 12, 13, 14, 15, 16, 17, 18, 19 mm; CrV: 1.5, 2, 2.5 mm; CrV 6150

YATO				
YT-3883	1/2" (12.7 mm)	3/8" (9.5 mm)	1/4" (6.3 mm)	2



120  
PCS

METRIC  
& S.A.E.

1/2" (12.7 mm): 20, 21, 22, 24 mm (L=38 mm); 27, 30, 32 mm (L=42 mm); 3/8" (9.5 mm): 9, 10, 11, 12, 13, 14, 15, 16 mm (L=28 mm); 17, 18, 19 mm (L=30 mm); 1/4" (6.3 mm): 4, 5, 6, 7, 8, 9, 10, 11, 12, 13 mm (L=25 mm); CrV 50BV30: 3/8" (9.5 mm): 13, 14, 15, 17 mm (L=63 mm); 1/4" (6.3 mm): 8, 9, 10, 12 mm (L=50 mm); CrV 50BV30: 1/2" (12.7 mm) x 15/16" (23.8 mm); 1/2" (12.7 mm) x 1" (25.4 mm); 1/2" (12.7 mm) x 1-1/16" (27.0 mm); 1/2" (12.7 mm) x 1-1/4" (31.8 mm); 3/8" (9.5 mm) x 3/8" (9.5 mm); 3/8" (9.5 mm) x 7/16" (11.1 mm); 3/8" (9.5 mm) x 1/2" (12.7 mm); 3/8" (9.5 mm) x 9/16" (14.3 mm); 3/8" (9.5 mm) x 5/8" (15.9 mm); 3/8" (9.5 mm) x 11/16" (17.5 mm); 3/8" (9.5 mm) x 3/4" (19.0 mm); 3/8" (9.5 mm) x 13/16" (20.6 mm); 3/8" (9.5 mm) x 7/8" (22.2 mm); 1/4" (6.3 mm) x 5/32" (4.0 mm); 1/4" (6.3 mm) x 3/16" (4.8 mm); 1/4" (6.3 mm) x 7/32" (5.6 mm); 1/4" (6.3 mm) x 1/4" (6.3 mm); 1/4" (6.3 mm) x 9/32" (7.1 mm); 1/4" (6.3 mm) x 5/16" (7.9 mm); 1/4" (6.3 mm) x 11/32" (8.7 mm); 1/4" (6.3 mm) x 3/8" (9.5 mm); 1/4" (6.3 mm) x 7/16" (11.1 mm); 1/4" (6.3 mm) x 1/2" (12.7 mm); CrV 50BV30: 1/2" (12.7 mm): 17, 19, 21, 23 mm; CrV 50BV30: 3/8" (9.5 mm): E8, E10, E11, E12, E14, E16, E18, E20; CrV 50BV30: 1/2" (12.7 mm): (127, 254 mm); 3/8" (9.5 mm): (76, 152.4 mm); 1/4" (6.3 mm): (50.8 mm); CrV 50BV30: 1/2" (12.7 mm); 3/8" (9.5 mm); 1/4" (6.3 mm); CrV 50BV30: 3/8" (9.5 mm); 16, 21 mm; CrV 50BV30: 1/2" (12.7 mm); (255 mm); 3/8" (9.5 mm); 200 mm; 1/4" (6.3 mm): (155 mm); 72T: CrV 6140: 1/4" (6.3 mm): (150 mm); CrV 50BV30: 1/4" (6.3 mm) x 1/4" (6.3 mm); CrV 6140: 1/4" (6.3 mm): T10, T15, T20, T25, T27, T30, T40 (L=25 mm); AISI S2: 3/8" (9.5 mm): 5.5, 6.5 mm (L=50 mm); AISI S2 / CrV 6150: 3/8" (9.5 mm): PH1, PH2 (L=50 mm); AISI S2 / CrV 6150: 3/8" (9.5 mm): PZ1, PZ2 (L=50 mm); AISI S2 / CrV 6150: 3/8" (9.5 mm): T20, T30, T40, T45, T50, T55, T60 (L=50 mm); AISI S2 / CrV 6150: 3/8" (9.5 mm): 3, 4, 5, 6 mm (L=50 mm); AISI S2 / CrV 6150: 8, 9, 10, 11, 12, 13, 14, 17, 18, 19 mm; CrV

YATO				
YT-3880	1/2" (12.7 mm)	3/8" (9.5 mm)	1/4" (6.3 mm)	2

# Sockets, accessories & sets Klucze nasadowe, akcesoria i zestawy



GB Tool set  
D Sechskant-Steckschlüssel-Satz  
PL Zestaw narzędziowy  
RUS Набор инструмента

CZ Sada nástrčných klíčů a ráčny  
H Dugókulcs készlet racsni hajtókarral  
RO Rotruşa chei tubulare cu antrenor  
F Coffret d'outillage

I Set di utensili  
E Juego de herramientas  
CN 套筒扳手组套

1/2" 12.5mm	3/8" 10mm	1/4" 6.3mm
CrV 50BV30	CrV 6150	CrV 6140
S2	72T	AS-DRIVE

2



128  
PCS

BMC & COLOR SLEEVE  
XL SIZE



1/2" (12.7 mm): 14, 15, 16, 17, 18, 19, 20, 21, 22, 24 mm (L=38 mm); 27, 30, 32 mm (L=42 mm), 3/8" (9.5 mm): 10, 11, 12, 13, 14, 15, 16 mm (L=28 mm); 17, 18 mm (L=30 mm), 1/4" (6.3 mm): 6, 7, 8, 9, 10, 11, 12, 13 mm (L=25 mm); CrV 50BV30: 1/2" (12.7 mm): 17, 18, 19, 22 mm (L=76 mm), 3/8" (9.5 mm): 8, 10, 12, 13, 14, 15 mm (L=63 mm), 1/4" (6.3 mm): 6, 7, 8, 10, 12, 13 mm (L=50 mm); CrV 50BV30: 1/2" (12.7 mm): 17, 19, 21, 22 mm; CrV 50BV30: 3/8" (9.5 mm): E8, E10, E11, E12, E14, E16; CrV 50BV30: 1/2" (12.7 mm): (127, 254 mm), 3/8" (9.5 mm): (152.4, 254 mm), 1/4" (6.3 mm): (50.8, 101.6 mm); CrV 50BV30: 3/8" (9.5 mm) (F) x 1/2" (12.7 mm) (M); CrV 50BV30: 1/2" (12.7 mm), 3/8" (9.5 mm), 1/4" (6.3 mm); CrV 50BV30: 1/2" (12.7 mm): 16, 21 mm; CrV 50BV30: 3/8" (9.5 mm): (198 mm), 1/4" (6.3 mm): (152.4 mm); CrV 50BV30: 1/2" (12.7 mm): (255 mm), 3/8" (9.5 mm): (200 mm), 1/4" (6.3 mm): (155 mm); 72T; CrV 6140: 1/4" (6.3 mm): (150 mm); CrV 50BV30: 1/2" (12.7 mm): (250 mm); CrV 50BV30: 3/8" (9.5 mm) x 5/16" (7.9 mm); CrV 6140: 1/2" (12.7 mm) x 3/8" (9.5 mm), 3/8" (9.5 mm) x 1/4" (6.3 mm); CrV 50BV30: 1/4" (6.3 mm) x 1/4" (6.3 mm); CrV 6140: 3/8" (9.5 mm): 5.5, 6.5 mm (L=70 mm); AISI S2: 3/8" (9.5 mm): PH1, PH2, PH3 (L=70 mm); AISI S2: 3/8" (9.5 mm): T20, T30, T40, T45, T50, T55 (L=70 mm); AISI S2: 3/8" (9.5 mm): 6, 7, 8, 10, 12 mm (L=70 mm); AISI S2: 1/4" (6.3 mm): PZ1, PZ2 (L=25 mm); AISI S2: 1/4" (6.3 mm): T8, T10 (L=25 mm); AISI S2: 1/4" (6.3 mm): 1/4" (6.3 mm): 4.0, 5.5, 6.5 mm (L=37 mm); AISI S2 / CrV 6150: 1/4" (6.3 mm): PH1, PH2 (L=37 mm); AISI S2 / CrV 6150: 1/4" (6.3 mm): T8, T10, T15, T20, T25, T30, T40 (L=37 mm); AISI S2 / CrV 6150: 1/4" (6.3 mm): 3, 4, 5, 6 mm (L=37 mm); AISI S2 / CrV 6150: 8, 10, 12, 13, 14, 15, 16, 17, 18, 19 mm; CrV: 1.5, 2, 2.5 mm; CrV 6150

YATO	1/2" (12.7 mm)	3/8" (9.5 mm)	1/4" (6.3 mm)	2
YT-3887				



129  
PCS

CrV  
55

SVC  
55

BMC & COLOR SLEEVE  
XXL SIZE



1/2" (12.7 mm): 12, 13, 14, 15, 16, 17, 18, 19, 20, 21, 22, 24 mm (L=38 mm); 27, 30, 32 mm (L=42 mm), 3/8" (9.5 mm): 10, 11, 12, 13, 14, 15, 16 mm (L=28 mm); 17, 18, 19 mm (L=30 mm), 1/4" (6.3 mm): 4, 4.5, 5, 5.5, 6, 7, 8, 9, 10, 11, 12, 13, 14 mm (L=25 mm); CrV 50BV30: 1/2" (12.7 mm): 10, 12, 13, 14, 17, 19 mm (L=76 mm), 1/4" (6.3 mm): 4, 5, 6, 7, 8, 9 mm (L=50 mm); CrV 50BV30: 1/2" (12.7 mm): 17, 19, 21, 23 mm; CrV 50BV30: 3/8" (9.5 mm): E8, E10, E11, E12, E14, E16, E18, E20; CrV 50BV30: 1/2" (12.7 mm): (127, 254 mm), 3/8" (9.5 mm): (76, 152.4 mm), 1/4" (6.3 mm): (50.8 mm); CrV 50BV30: 1/2" (12.7 mm), 3/8" (9.5 mm), 1/4" (6.3 mm); CrV 50BV30: 3/8" (9.5 mm): 16, 21 mm; CrV 50BV30: 1/2" (12.7 mm): (255 mm), 3/8" (9.5 mm): (200 mm), 1/4" (6.3 mm): (155 mm); 72T; CrV 6140: 1/4" (6.3 mm): (150 mm); CrV 50BV30: 3/8" (9.5 mm): 4.0, 5.5, 6.5 mm (L=50 mm); AISI S2 / CrV 6150: 3/8" (9.5 mm): PH1, PH2, PH3 (L=50 mm); AISI S2 / CrV 6150: 3/8" (9.5 mm): PZ1, PZ2, PZ3 (L=50 mm); AISI S2 / CrV 6150: 3/8" (9.5 mm): T20, T30, T40, T45, T50, T55, T60 (L=50 mm); AISI S2 / CrV 6150: 3/8" (9.5 mm): 3, 4, 5, 6, 8, 10 mm (L=50 mm); AISI S2 / CrV 6150: 8, 10, 11, 12, 13, 14, 15, 16, 17, 18, 19, 22 mm; CrV: 3x75, 4x100, 6.5x150, PH1x75, PH2x100, PH3x150 mm; SVC/55: 180 mm; CrV 55: 160 mm; CrV 55: 160 mm; CrV 55: 1.5, 2, 2.5, 3, 4, 5, 6, 7, 8, 10 mm; CrV 6150

YATO	1/2" (12.7 mm)	3/8" (9.5 mm)	1/4" (6.3 mm)	2
YT-3888				

GB Tool set  
D Sechskant-Steckschlüssel-Satz  
PL Zestaw narzędziowy  
RUS Набор инструмента

CZ Sada nástrčných klíčů a ráčny  
H Dugókulcs készlet racsnis hajtókarral  
RO Rotrusa chei tubulare cu antrenor  
F Coffret d'outillage

I Set di utensili  
E Juego de herramientas  
CN 套筒扳手组套

1/2" 12.5mm	3/8" 10mm	1/4" 6.3mm	CrV 50BV30	CrV 6150
CrV 6140	S2	72T	AS-DRIVE	

2



**150**  
PCS

METRIC  
& S.A.E.

BMC & COLOR  
SLEEVE  
XXL SIZE



1/2" (12.7 mm): 20, 21, 22, 24 mm (L=38 mm); 27, 30, 32 mm (L=42 mm); 3/8" (9.5 mm): 9, 10, 11, 12, 13, 14, 15, 16 mm (L=28 mm); 17, 18, 19 mm (L=30 mm); 1/4" (6.3 mm): 4, 5, 6, 7, 8, 9, 10, 11, 12, 13 mm (L=25 mm); CrV 50BV30: 1/2" (12.7 mm): 10, 12, 13, 14, 17, 19 mm (L=76 mm); 3/8" (9.5 mm): 10, 11, 12, 13, 14, 15 mm (L=63 mm); 1/4" (6.3 mm): 4, 5, 6, 7, 8, 9 mm (L=50 mm); CrV 50BV30: 1/2" (12.7 mm) x 15/16" (23.8 mm); 1/2" (12.7 mm) x 1" (25.4 mm); 1/2" (12.7 mm) x 1-1/16" (27.0 mm); 1/2" (12.7 mm) x 1-1/4" (31.8 mm); 3/8" (9.5 mm) x 3/8" (9.5 mm); 3/8" (9.5 mm) x 7/16" (11.1 mm); 3/8" (9.5 mm) x 1/2" (12.7 mm); 3/8" (9.5 mm) x 9/16" (14.3 mm); 3/8" (9.5 mm) x 5/8" (15.9 mm); 3/8" (9.5 mm) x 11/16" (17.5 mm); 3/8" (9.5 mm) x 3/4" (19.0 mm); 3/8" (9.5 mm) x 13/16" (20.6 mm); 3/8" (9.5 mm) x 7/8" (22.2 mm); 1/4" (6.3 mm) x 5/32" (4.0 mm); 1/4" (6.3 mm) x 3/16" (4.8 mm); 1/4" (6.3 mm) x 7/32" (5.6 mm); 1/4" (6.3 mm) x 1/4" (6.3 mm); 1/4" (6.3 mm) x 9/32" (7.1 mm); 1/4" (6.3 mm) x 5/16" (7.9 mm); 1/4" (6.3 mm) x 11/32" (8.7 mm); 1/4" (6.3 mm) x 3/8" (9.5 mm); 1/4" (6.3 mm) x 7/16" (11.1 mm); 1/4" (6.3 mm) x 1/2" (12.7 mm); CrV 50BV30: 1/2" (12.7 mm): 17, 19, 21, 23 mm; CrV 50BV30: 3/8" (9.5 mm): E8, E10, E11, E12, E14, E16, E18, E20; CrV 50BV30: 1/2" (12.7 mm): (127, 254 mm); 3/8" (9.5 mm): (76, 152.4 mm); 1/4" (6.3 mm): (50.8 mm); CrV 50BV30: 1/2" (12.7 mm); 3/8" (9.5 mm); 1/4" (6.3 mm); CrV 50BV30: 3/8" (9.5 mm): 16, 21 mm; CrV 50BV30: 1/2" (12.7 mm): (255 mm); 3/8" (9.5 mm): (200 mm); 1/4" (6.3 mm): (155 mm); 72T: CrV 6140: 1/2" (12.7 mm): (150 mm); CrV 50BV30: 1/4" (6.3 mm) x 1/4" (6.3 mm); CrV 6140: 1/4" (6.3 mm): T10, T15, T20, T25, T27, T30, T40 (L=25 mm); AISI S2: 3/8" (9.5 mm): 4, 5, 5.5, 6.5 mm (L=50 mm); AISI S2 / CrV 6150: 3/8" (9.5 mm): PH1, PH2, PH3 (L=50 mm); AISI S2 / CrV 6150: 3/8" (9.5 mm): PZ1, PZ2, PZ3 (L=50 mm); AISI S2 / CrV 6150: 3/8" (9.5 mm): T20, T30, T40, T45, T50, T55, T60 (L=50 mm); AISI S2 / CrV 6150: 3/8" (9.5 mm): 3, 4, 5, 6, 8, 10 mm (L=50 mm); AISI S2 / CrV 6150: 8, 9, 10, 11, 12, 13, 14, 15, 16, 17, 18, 19 mm; CrV: 8x10, 12x13, 17x19 mm; 1.5, 2, 2.5, 3, 4, 5, 6, 7, 8, 10 mm; CrV 6150

YATO	1/2" (12.7 mm)	3/8" (9.5 mm)	1/4" (6.3 mm)	2
YT-3881				



**173**  
PCS

BMC & COLOR  
SLEEVE  
XL SIZE



1/2" (12.7 mm): 10, 11, 12, 13, 14, 15, 16, 17, 18, 19, 20, 21, 22, 23, 24 mm (L=38 mm); 27, 30, 32 mm (L=42 mm); 3/8" (9.5 mm): 10, 11, 12, 13, 14, 15, 16 mm (L=28 mm); 17, 18, 19 mm (L=30 mm); 1/4" (6.3 mm): 4, 4.5, 5, 5.5, 6, 7, 8, 9, 10, 11, 12, 13, 14 mm (L=25 mm); CrV 50BV30: 1/2" (12.7 mm): 16, 17, 18, 19, 22 mm (L=76 mm); 3/8" (9.5 mm): 10, 11, 12, 13, 14, 15 mm (L=63 mm); 1/4" (6.3 mm): 4, 5, 6, 7, 8, 9, 10 mm (L=50 mm); CrV 50BV30: 1/2" (12.7 mm): E18, E20, E24, 3/8" (9.5 mm): E10, E11, E12, E14, E16, 1/4" (6.3 mm): E4, E5, E6, E7, E8; CrV 50BV30: 1/2" (12.7 mm): (127, 254 mm); 3/8" (9.5 mm): (152.4 mm); 1/4" (6.3 mm): (50.8, 101.6 mm); CrV 50BV30: 3/8" (9.5 mm) (F) x 1/2" (12.7 mm) (M); CrV 50BV30: 1/2" (12.7 mm); 3/8" (9.5 mm); 1/4" (6.3 mm); CrV 50BV30: 1/2" (12.7 mm): 16, 21 mm; 3/8" (9.5 mm): 18 mm; CrV 50BV30: 1/4" (6.3 mm): (152.4 mm); CrV 50BV30: 1/2" (12.7 mm): (255 mm); 3/8" (9.5 mm): (200 mm); 1/4" (6.3 mm): (155 mm); 72T: CrV 6140: 1/4" (6.3 mm): (150 mm); CrV 50BV30: 1/2" (12.7 mm) x 5/16" (7.9 mm); 3/8" (9.5 mm) x 5/16" (7.9 mm); CrV 6140: 1/4" (6.3 mm) x 1/4" (6.3 mm); CrV 6140: 5/16" (7.9 mm): 8, 10, 12 mm (L=30 mm); AISI S2: 5/16" (7.9 mm): PH3, PH4 (L=30 mm); AISI S2: 5/16" (7.9 mm): PZ3, PZ4 (L=30 mm); AISI S2: 5/16" (7.9 mm): T40, T45, T50, T55, T60, T70 (L=30 mm); AISI S2: 5/16" (7.9 mm): T40, T45, T50, T55, T60, T70 (L=30 mm); AISI S2: 5/16" (7.9 mm): 7, 8, 10, 12, 14 mm (L=30 mm); AISI S2: 1/4" (6.3 mm): T5, T6, T7 (L=25 mm); AISI S2: 1/4" (6.3 mm): T7, T10, T15, T20, T25, T27, T30, T40, T45 (L=25 mm); AISI S2: 1/4" (6.3 mm): M5, M6, M8 (L=25 mm); AISI S2: 1/4" (6.3 mm): RM5, RM6, RM7, RM8, RM9 (L=25 mm); AISI S2: 1/4" (6.3 mm): 4, 5.5, 6.5, 7 mm (L=37 mm); AISI S2 / CrV 6150: 1/4" (6.3 mm): PH0, PH1, PH2 (L=37 mm); AISI S2 / CrV 6150: 1/4" (6.3 mm): PZ0, PZ1, PZ2 (L=37 mm); AISI S2 / CrV 6150: 1/4" (6.3 mm): T8, T9, T10, T15, T20, T25, T27, T30 (L=37 mm); AISI S2 / CrV 6150: 1/4" (6.3 mm): T8, T9, T10, T15, T20, T25, T27, T30 (L=37 mm); AISI S2 / CrV 6150: 1/4" (6.3 mm): 3, 4, 5, 6 mm (L=37 mm); AISI S2 / CrV 6150: 1.25, 1.5, 2, 2.5, 3, 4, 5 mm; CrV 6150

YATO	1/2" (12.7 mm)	3/8" (9.5 mm)	1/4" (6.3 mm)	2
YT-3893				

GB Tool set  
 D Sechskant-Steckschlüssel-Satz  
 PL Zestaw narzędziowy  
 RUS Набор инструмента

CZ Sada nástrčných klíčů a ráčny  
 H Dugókulcs készlet racsni hajtókarral  
 RO Rotrua sa chei tubulare cu antrenor  
 F Coffret d'outillage

I Set di utensili  
 E Juego de herramientas  
 CN 套筒扳手组套

1/2" 12.5mm	3/8" 10mm	1/4" 6.3mm	CrV 50BV30	CrV 6150
CrV 6140	S2	72T	AS-DRIVE	MAGNETIC

2



**216**  
PCS

BMC & COLOR  
SLEEVE  
XXL SIZE



1/2" (12.7 mm): 10, 11, 12, 13, 14, 15, 17, 19, 20, 21, 22, 24 mm (L=38 mm); 27, 30, 32 mm (L=42 mm); 3/8" (9.5 mm): 10, 11, 12, 13, 14, 15, 16 mm (L=28 mm); 17, 18, 19 mm (L=30 mm); 1/4" (6.3 mm): 4, 4.5, 5, 5.5, 6, 7, 8, 9, 10, 11, 12, 13, 14 mm (L=25 mm); CrV 50BV30: 1/2" (12.7 mm): 16, 17, 18, 19, 22 mm (L=76 mm); 3/8" (9.5 mm): 10, 11, 12, 13, 14, 15 mm (L=63 mm); 1/4" (6.3 mm): 4, 5, 6, 7, 8, 9, 10 mm (L=50 mm); CrV 50BV30: 1/2" (12.7 mm): E20, E22, E24, 3/8" (9.5 mm): E10, E11, E12, E14, E16, E18, 1/4" (6.3 mm): E4, E5, E6, E7, E8; CrV 50BV30: 1/2" (12.7 mm): (127, 254 mm); 3/8" (9.5 mm): (125 mm); 1/4" (6.3 mm): (50.8, 101.6 mm); CrV 50BV30: 1/2" (12.7 mm); 3/8" (9.5 mm); 1/4" (6.3 mm); CrV 50BV30: 1/2" (12.7 mm): 16, 21 mm; 3/8" (9.5 mm): 18 mm; CrV 50BV30: 1/2" (12.7 mm): (255 mm); 1/4" (6.3 mm): (152.4 mm); CrV 50BV30: 1/2" (12.7 mm): (255 mm); 3/8" (9.5 mm): (200 mm); 1/4" (6.3 mm): (155 mm); 72T; CrV 6140: 1/4" (6.3 mm): (150 mm); CrV 50BV30: 1/4" (6.3 mm); (200 mm); CrV 6140: 1/2" (12.7 mm); 1/4" (6.3 mm); 5/16" (7.9 mm); 3/8" (9.5 mm) x 5/16" (7.9 mm); CrV 6140: 1/4" (6.3 mm) x 1/4" (6.3 mm); CrV 6140: 5/16" (7.9 mm): 6, 6.5, 8 mm (L=30 mm); AISI S2: 5/16" (7.9 mm): PH3, PH4 (L=30 mm); AISI S2: 5/16" (7.9 mm): PZ3, PZ4 (L=30 mm); AISI S2: 5/16" (7.9 mm): T25, T27, T30, T35, 2xT40, T45, T50 (L=30 mm); AISI S2: 5/16" (7.9 mm): T27, T30, T35, T40, T45, T50 (L=30 mm); AISI S2: 5/16" (7.9 mm): 5.5, 6, 6.5, 7, 8 mm (L=30 mm); AISI S2: 5/16" (7.9 mm): M5, M6, M8, M10 (L=30 mm); AISI S2: 1/4" (6.3 mm): 4, 5, 5.5, 6, 6.5 mm (L=25 mm); AISI S2: 1/4" (6.3 mm): PH1, PH2 (L=25 mm); AISI S2: 1/4" (6.3 mm): PZ1, PZ2 (L=25 mm); AISI S2: 1/4" (6.3 mm): T8, T10, T15, T20, T25 (L=25 mm); AISI S2: 1/4" (6.3 mm): T8, 2xT10, 2xT15, 2xT20, 2xT25, T40 (L=25 mm); AISI S2: 1/4" (6.3 mm): 3, 4, 5, 6 mm (L=25 mm); AISI S2: 1/4" (6.3 mm): 3, 4, 5, 6 mm (L=25 mm); AISI S2: 1/4" (6.3 mm): M5, M6, M8 (L=25 mm); AISI S2: 1/4" (6.3 mm): S1, S2 (L=25 mm); AISI S2: 1/4" (6.3 mm): 1, 2, 3 mm (L=25 mm); AISI S2: 1/4" (6.3 mm): 6, 8, 10 mm (L=25 mm); AISI S2: 1/4" (6.3 mm): 4, 6, 8 mm (L=25 mm); AISI S2: 1/2" (12.7 mm): T55, T60 (L=50 mm); AISI S2 / CrV 6150: 1/4" (6.3 mm): 6, 6.5, 8 mm (L=37 mm); AISI S2 / CrV 6150: 1/4" (6.3 mm): PH3, PH4 (L=37 mm); AISI S2 / CrV 6150: 1/4" (6.3 mm): PZ3, PZ4 (L=37 mm); AISI S2 / CrV 6150: 1/4" (6.3 mm): T25, T27, T30, T35, 2xT40, T45, T50 (L=37 mm); AISI S2 / CrV 6150: 1/4" (6.3 mm): T27, T30, T35, T40, T45, T50 (L=37 mm); AISI S2 / CrV 6150: 1/4" (6.3 mm): 5.5, 6, 6.5, 7, 8 mm (L=37 mm); AISI S2 / CrV 6150: 1/4" (6.3 mm): M5, M6, M8, M10 (L=37 mm); AISI S2 / CrV 6150: 8, 10, 11, 12, 13, 14, 15, 16, 17, 18, 19, 22 mm; CrV: 1.27, 1.5, 2, 2.5, 3, 4, 5 mm; CrV 6150

<b>YATO</b>	○	○	○	📦
YT-3884	1/2" (12.7 mm)	3/8" (9.5 mm)	1/4" (6.3 mm)	2



**224**  
PCS

METRIC  
& S.A.E.

CrV  
55

BMC & COLOR  
SLEEVE  
XXXL SIZE



1/2" (12.7 mm): 10, 13, 15, 16, 17, 18, 19, 20, 21, 22, 23, 24 mm (L=38 mm); 3/8" (9.5 mm): 10, 11, 12, 13, 14, 15, 16 mm (L=28 mm); 1/4" (6.3 mm): 3.5, 4, 4.5, 5, 5.5, 6, 7, 8, 9, 10, 11, 12, 13, 14 mm (L=25 mm); CrV 50BV30: 1/2" (12.7 mm): 10, 11, 12, 13, 14, 15, 17, 19, 21 mm (L=76 mm); 3/8" (9.5 mm): 6, 7, 8, 9, 10 mm (L=63 mm); CrV 50BV30: 1/2" (12.7 mm) x 7/16" (11.1 mm); 1/2" (12.7 mm) x 1/2" (12.7 mm); 1/2" (12.7 mm) x 9/16" (14.3 mm); 1/2" (12.7 mm) x 5/8" (15.9 mm); 1/2" (12.7 mm) x 11/16" (17.5 mm); 1/2" (12.7 mm) x 3/4" (19.0 mm); 1/2" (12.7 mm) x 13/16" (20.6 mm); 1/2" (12.7 mm) x 7/8" (22.2 mm); 1/4" (6.3 mm) x 1/4" (6.3 mm); 1/4" (6.3 mm) x 9/32" (7.1 mm); 1/4" (6.3 mm) x 5/16" (7.9 mm); 1/4" (6.3 mm) x 11/32" (8.7 mm); 1/4" (6.3 mm) x 3/8" (9.5 mm); CrV 50BV30: 1/2" (12.7 mm): 17, 19, 21 mm; CrV 50BV30: 1/2" (12.7 mm): E16, E18, E20, E22, E24, 3/8" (9.5 mm): E10, E11, E12, E14, 1/4" (6.3 mm): E4, E5, E6, E7, E8; CrV 50BV30: 1/2" (12.7 mm): (127, 254 mm); 3/8" (9.5 mm): (76, 254 mm); 1/4" (6.3 mm): (50.8, 101.6 mm); CrV 50BV30: 3/8" (9.5 mm) (F) x 1/2" (12.7 mm) (M); 1/2" (12.7 mm) (F) x 3/8" (9.5 mm) (M); CrV 50BV30: 1/2" (12.7 mm); 3/8" (9.5 mm); 1/4" (6.3 mm); CrV 50BV30: 1/2" (12.7 mm): 16, 21 mm; 3/8" (9.5 mm); 1/4" (6.3 mm); (152.4 mm); CrV 50BV30: 1/2" (12.7 mm): (255 mm); 3/8" (9.5 mm): (200 mm); 1/4" (6.3 mm): (155 mm); 72T; CrV 6140: 1/4" (6.3 mm): (150 mm); CrV 50BV30: 1/4" (6.3 mm); (200 mm); CrV 6140: 1/2" (12.7 mm); 1/4" (6.3 mm); 5/16" (7.9 mm); 3/8" (9.5 mm) x 5/16" (7.9 mm); CrV 6140: 1/4" (6.3 mm) x 1/4" (6.3 mm); CrV 6140: 5/16" (7.9 mm): 6, 6.5, 8 mm (L=30 mm); AISI S2: 5/16" (7.9 mm): PH3, PH4 (L=30 mm); AISI S2: 5/16" (7.9 mm): PZ3, PZ4 (L=30 mm); AISI S2: 5/16" (7.9 mm): T40, T45, T50, T55, T60, T70 (L=30 mm); AISI S2: 5/16" (7.9 mm): T40, T45, T50, T55, T60, T70 (L=30 mm); AISI S2: 5/16" (7.9 mm): 10, 12, 14 mm (L=30 mm); AISI S2: 1/4" (6.3 mm): 3, 4, 5, 6, 5, 6, 7, 8 mm (L=25 mm); AISI S2: 1/4" (6.3 mm): PH0, PH1, PH2, PH3 (L=25 mm); AISI S2: 1/4" (6.3 mm): PZ0, PZ1, PZ2, PZ3 (L=25 mm); AISI S2: 1/4" (6.3 mm): T8, T9, T10, T15, T20, T25, T27, T30 (L=25 mm); AISI S2: 1/4" (6.3 mm): T8, T9, T10, T15, T20, T25, T27, T30 (L=25 mm); AISI S2: 1/4" (6.3 mm): 3, 4, 5, 6, 7, 8 mm (L=25 mm); AISI S2: 1/4" (6.3 mm): 1, 2, 3, 4 mm (L=25 mm); AISI S2: 1/4" (6.3 mm): 6, 8, 10 mm (L=25 mm); AISI S2: 1/4" (6.3 mm): 4, 6, 8, 10 mm (L=25 mm); AISI S2: 1/4" (6.3 mm): 8, 9, 10, 11, 12, 13, 14, 15, 17, 19, 22 mm; CrV: 6.5x38 mm, PH2x38 mm; SVCM55: 180 mm; CrV 55: 250 mm; CrV: 2, 2.5, 3, 4, 5, 6, 7, 8, 10, 12 mm; CrV 6150

<b>YATO</b>	○	○	○	📦
YT-3894	1/2" (12.7 mm)	3/8" (9.5 mm)	1/4" (6.3 mm)	2

- GB Torx socket
- D Torx-Steckschlüssel
- PL Nasadka Torx
- RUS Головка
- CZ Nástavec Torx
- H Hatszögű rátét Torx
- RO Cheie tubulară Torx
- F Douille Torx
- I Bullone Torx
- E Boquilla Torx
- CN 星型套筒

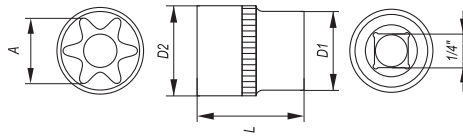

COLOR BOX



1/4" 6.3mm TORX CrV 50BV30

YATO	A (mm)	D1 (mm)	D2 (mm)	L (mm)	PCS packing	
YT-05211	E4	11.9	6.7	25	24	240/480
YT-05212	E5	11.9	7.2	25	24	240/480
YT-05213	E6	11.9	8.3	25	24	240/480
YT-05214	E7	11.9	9.4	25	24	240/480
YT-05215	E8	11.9	10.0	25	24	240/480

- GB Torx socket set
- D Torx-Steckschlüsselsatz
- PL Klucze nasadowe Torx
- RUS Набор головок
- CZ Nástrčné kľíče
- H Dugókulcs
- RO Trusa tubulară
- F Clés à tube
- I Chiavi a bussola bulloni Torx
- E Llaves de vaso
- CN 星型套筒组套



9 PCS TORX CrV 50BV30



1/4" (6.3 mm): E5, E6, E7, E8, 3/8" (9.5 mm): E10, E12, E14, E16;  
 1/4" (6.3 mm) (M) x 3/8" (9.5 mm) (F)

YATO		
YT-0520	1/4" (6.3 mm)	10/40

- GB Torx socket
- D Torx-Steckschlüssel
- PL Nasadka Torx
- RUS Головка
- CZ Nástavec Torx
- H Hatszögű rátét Torx
- RO Cheie tubulară Torx
- F Douille Torx
- I Bullone Torx
- E Boquilla Torx
- CN 星型套筒

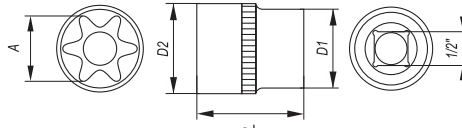

1/2" 12.5mm TORX CrV 50BV30

COLOR BOX



YATO	A (mm)	D1 (mm)	D2 (mm)	L (mm)	PCS packing	
YT-05220	E10	21.8	13.1	38	12	120/240
YT-05221	E11	21.8	13.9	38	12	120/240
YT-05222	E12	21.8	14.9	38	12	120/240
YT-05223	E14	21.8	16.3	38	12	120/240
YT-05224	E16	21.8	18.2	38	12	120/240

YATO	A (mm)	D1 (mm)	D2 (mm)	L (mm)	PCS packing	
YT-05225	E18	23.8	19.4	38	12	120/240
YT-05226	E20	21.8	23.9	38	12	120/240
YT-05227	E22	23.2	25.7	38	12	120/240
YT-05228	E24	23.8	27.8	38	12	60/120

- GB Torx socket set
- D Torx-Steckschlüsselsatz
- PL Klucze nasadowe Torx
- RUS Набор головок
- CZ Nástrčné kľíče
- H Dugókulcs
- RO Trusa tubulară
- F Clés à tube
- I Chiavi a bussola bulloni Torx
- E Llaves de vaso
- CN 星型套筒组套



9 PCS TORX CrV 50BV30

METAL CASE & COLOR SLEEVE



1/2" (12.7 mm): E10, E11, E12, E14, E16, E18, E20, E22, E24

YATO		
YT-0521	1/2" (12.7 mm)	20

- GB Go-through socket set
- D Durchgangs-Knarrenkasten
- PL Zestaw nasadek przelotowych z grzechotką
- RUS Набор торцевых головок сквозных с гречоткой
- CZ Sada průchodných nástrčných kľíčů

- H Dugókulcs készlet, csavarszár átengedős
- RO Set chei tubulare cu cricchet
- F Set de douilles à cliquet
- I Set chiavi a bussola con cricchetto

- E Juego de boquillas con orificio pasante, con carraca
- CN 套筒扳手组套

21 PCS 1/2" 12.5mm 1/4" 6.3mm CrV 50BV30 CrV 6140 QUICK RELEASE SZYBKÓ-ZŁĄCZACZE

METRIC METRYCZNE IMPERIAL



10, 11, 12, 13, 14, 15, 16, 17, 18, 19 mm (L=32 mm);  
 3/8" (9.5 mm), 7/16" (11.1 mm), 1/2" (12.7 mm), 9/16" (14.3 mm),  
 5/8" (15.9 mm), 11/16" (17.5 mm), 3/4" (19.0 mm) (L=32 mm); CrV 50BV30;  
 L=178 mm; CrV 6140; 1/2" (12.7 mm), 1/4" (6.3 mm); CrV 6140;  
 17 mm (L=75 mm); CrV 50BV30

YATO			
YT-3865	1/2" (12.7 mm)	1/4" (6.3 mm)	3/12

BMC & COLOR SLEEVE



- GB Hexagonal socket  
D Sechskantenschlüssel  
PL Nasadka sześciokątna  
RUS Головка шестигранная  
CZ Šestihranný nástavec  
H Hatszögű rátét  
RO Cheie tubulară hexagonală  
F Douille 6 pans  
I Chiave a bussola esagonale  
E Boquilla hexagonal  
CN 六角套筒

- application: industry, car service stations and workshops
- for high loads
- drive locks
- surface finish: chromed, satin
- przeznaczenie: przemysł, serwisy i warsztaty
- do największych obciążeń
- zamki blokujące
- wykończenie powierzchni: chromowana, satynowa

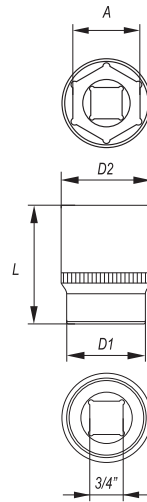

INCREASED CONTACT AREA

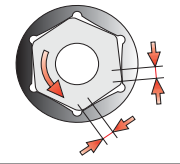

3/4" 19mm  
DIN 3121  
CrV 50BV30  
AS-DRIVE



YATO	∅ A (mm)	D1 (mm)	D2 (mm)	L (mm)	PCS packing	
YT-1301	19	30	36	50	12	96
YT-1302	21	32	36	50	12	96
YT-1303	22	32	36	50	12	96
YT-1304	23	34	36	50	12	96
YT-1305	24	34	36	50	12	96
YT-1306	25	36	36	50	12	96
YT-1307	26	37	34	50	12	96
YT-1308	27	38	34	50	12	96
YT-1309	28	40	34	50	12	96
YT-1310	29	40	35	50	12	96
YT-1311	30	42	36	55	8	48
YT-1312	32	44	37	55	8	48
YT-1313	33	46	38	55	8	48

YATO	∅ A (mm)	D1 (mm)	D2 (mm)	L (mm)	PCS packing	
YT-1314	34	47	38	55	8	48
YT-1315	35	48	42	60	6	36
YT-1316	36	50	42	60	6	36
YT-1317	38	52	45	60	6	36
YT-1318	41	56	45	65	4	32
YT-1319	42	57	45	65	4	32
YT-1320	43	58	45	65	4	32
YT-1322	46	62	48	70	4	32
YT-1323	48	64	48	70	4	24
YT-1324	50	68	48	70	4	24
YT-1326	52	70	48	70	4	20
YT-1328	55	73	48	75	4	20
YT-1330	60	80	48	80	4	20

- GB Extension bar  
D Verlängerung  
PL Przedłużka  
RUS Удлинитель для воротка  
CZ Prodlužovací přípravek  
H Toldalék  
RO Prelungitor  
F Rallonge  
I Prolunga  
E Tubo de prolongación  
CN 接杆

3/4" 19mm  
DIN 3121  
CrV 50BV30

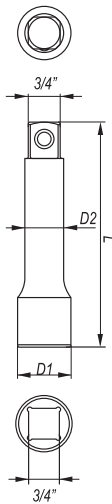

YATO	∅	D1 (mm)	D2 (mm)	L (mm)	PCS packing	
YT-1340	3/4" (19.0 mm)	36	22	100	6	36
YT-1341	3/4" (19.0 mm)	36	22	200	5	20
YT-1342	3/4" (19.0 mm)	36	22	400	5	10

- GB Sliding T-bar  
D Handgriff mit Gleitstück  
PL Pokrętko typu „T”  
RUS Вороток T-образный  
CZ Otočná račká typ „T”  
H „T” alakú hajtókar  
RO Mâner clupă tipul „T”  
E Mango tipo „T”  
F Barre type „T”  
I Manopola „T” scorrevole  
CN 滑行杆

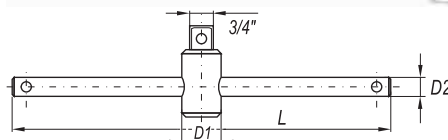

3/4" 19mm  
DIN 3121  
CrV 50BV30



YATO	∅	D1 (mm)	D2 (mm)	L (mm)	PCS packing	
YT-1350	3/4" (19.0 mm)	37	20	500	5	10

- GB Adapter  
D Reduktion  
PL Redukcja  
RUS Переходник  
CZ Redukce  
H Redukció  
RO Reducție  
F Réduction  
I Riduttore  
E Reducción  
CN 转换头

3/4" 19mm  
DIN 3121  
CrV 50BV30

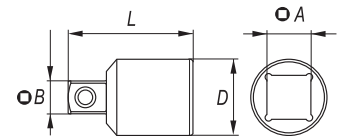

YATO	∅ A	∅ B	D (mm)	L (mm)	PCS packing	
YT-1355	3/4" (19.0 mm)	(F) 1/2" (12.7 mm)	(M) 36	53	12	48

- GB Universal joint  
D Kardangelen  
PL Przegub Cardana  
RUS Карданный шарнир  
CZ Kardanový kloub  
H Kardán csukló
- RO Articulație Cardanică  
F Cardan  
I Snodo cardanico  
E Articulación Cardan  
CN 万向接头

3/4" 19mm  
DIN 3121  
CrV 50BV30

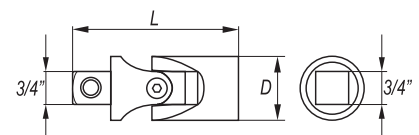

YATO	∅	D (mm)	L (mm)	PCS packing	
YT-1352	3/4" (19.0 mm)	40	106	12	36

- GB Flexible handle
- D Gelenkgriff
- PL Pokręto lamane
- RUS Вороток шарнирный
- CZ Otočná lomená ráčka
- H Hajlított hajtókár
- RO Prelungitor cu prindere flexibilă
- F Barre pivotante
- I Manopola a snodo
- E Mango articulado
- CN 转向手柄

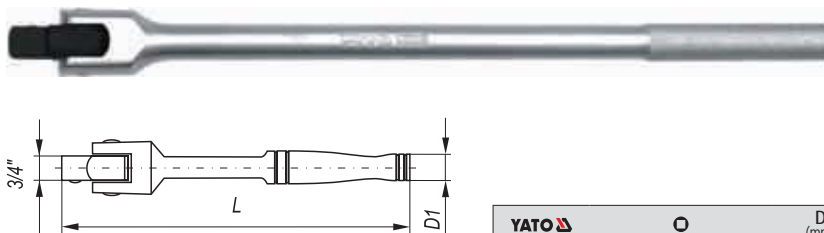

3/4" 19mm  
DIN 3121  
CrV 50BV30



YATO	Ø	D (mm)	L (mm)	PCS packing	Box
YT-1345	3/4" (19.0 mm)	25	507	5	10

- GB L-type handle
- D Admutterschlüssel
- PL Pokręto typu „L”
- RUS Вороток 1/2" тип „L”
- CZ Páka zahnutá
- H „L” alakú hajtókár
- RO Mâner clupă tipul „L”
- F Barre type „L”
- I Leva tipo „L”
- E Mango tipo „L”
- CN L型套筒扳手



3/4" 19mm  
DIN 3121  
CrV 50BV30



YATO	Ø	D (mm)	L (mm)	PCS packing	Box
YT-1347	3/4" (19.0 mm)	25	385	5	10
YT-1348	3/4" (19.0 mm)	25	440	5	10

- GB Quick release ratchet handle
- D Hebelumschaltknarre
- PL Grzechotka
- RUS Трещотка
- CZ Řehtačka
- H Racsnis hajtókár
- RO Dispozitiv de prindere cu clichet
- F Clé à cliquet
- I Cricchetto bussola
- E Carraca
- CN 快速脱落棘轮扳手

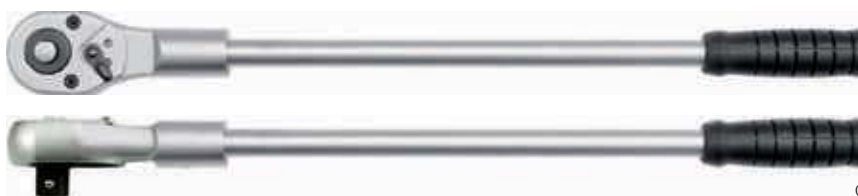

3/4" 19mm  
DIN 3122  
24T

QUICK RELEASE SZYBKO-ZŁĄCZE  
CrV 6140



YATO	Ø	T	L (mm)	Box
YT-1360	3/4" (19.0 mm)	24	625	10

- GB Socket set
- D Sechskant-Steckschlüssel-Satz
- PL Komplet nasadek z akcesoriami
- RUS Набор насадок
- CZ Sada nástrčných kľúčů a ráčny
- H Dugókulcs készlet racsnis hajtókarral

- RO Rotrușă chei tubulare cu antrenor
- F Clé à cliquet
- I Cricchetto bussola
- E Juego de boquillas con accesorios
- CN 套筒扳手套组



3/4" 19mm  
CrV 50BV30  
CrV 6140

QUICK RELEASE SZYBKO-ZŁĄCZE  
24T

AS-DRIVE



3/4" (19.0 mm): 30, 32, 34 (L=55 mm); 36, 38 (L=60 mm); 41 (L=65 mm); 46, 50 (L=70 mm); 55 (L=75 mm); 60 mm (L=80 mm); CrV 50BV30; 3/4" (19.0 mm); (L=500 mm); 24T; CrV 6140; 3/4" (19.0 mm); (L=500 mm); CrV 50BV30; 3/4" (19.0 mm); (L=100, 200 mm); CrV 50BV30; 3/4" (19.0 mm); (L=106 mm); CrV 50BV30

15 PCS

YATO	Ø	Box
YT-1334	3/4" (19.0 mm)	1

3/4" (19.0 mm): 19, 21, 22, 24 mm (L=50 mm); 26, 27, 28 mm (L=52 mm); 30, 32 mm (L=53 mm); 33, 34 mm (L=56 mm); 36 mm (L=58 mm); 38 mm (L=60 mm); 41 mm (L=64 mm); 46 mm (L=68 mm); 50 mm (L=72mm); CrV 50BV30; 3/4" (19.0 mm) x 620 mm; CrV 6140; 3/4" (19.0 mm); (L=500 mm); CrV 50BV30; 3/4" (19.0 mm) x 100 mm; 3/4" (19.0 mm) x 200 mm; CrV 50BV30

20 PCS

YATO	Ø	Box
YT-1335	3/4" (19.0 mm)	1



- GB Star bit sockets  
D Aufsteckschlüssel  
PL Klucze trzpieniowe  
RUS Набор головок-вставок  
CZ Čepové klíče  
H Csapkulcs
- RO Chei cu cozi  
F Douille tournevis  
I Chiavi a bussola  
E Llaves de mandril  
CN 星型旋具套筒



SLIDING CARD

1/4"	AISI S2
6.3mm	
DIN 3120	HRC 58-62

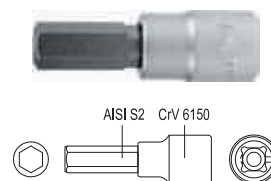
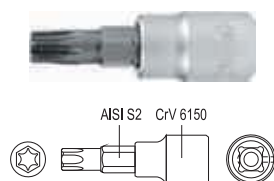

YATO	Ø	☆	L (mm)	torque / moment obrotowy max. (Nm)	☐
YT-7660	1/4" (6.3 mm)	T8	37	3.9	10/100
YT-7661	1/4" (6.3 mm)	T10	37	5.9	10/100
YT-7662	1/4" (6.3 mm)	T15	37	9.8	10/100
YT-7663	1/4" (6.3 mm)	T20	37	18.6	10/100
YT-7664	1/4" (6.3 mm)	T25	37	26.5	10/100
YT-7665	1/4" (6.3 mm)	T30	37	42.9	10/100
YT-7666	1/4" (6.3 mm)	T40	37	75.8	10/100

YATO	Ø	⬡	L (mm)	torque / moment obrotowy max. (Nm)	☐
YT-7667	1/4" (6.3 mm)	3	37	14.7	10/100
YT-7668	1/4" (6.3 mm)	4	37	26.5	10/100
YT-7669	1/4" (6.3 mm)	5	37	53.8	10/100
YT-7670	1/4" (6.3 mm)	6	37	88.6	10/100
YT-7671	1/4" (6.3 mm)	7	37	120.6	10/100
YT-7672	1/4" (6.3 mm)	8	37	170.2	10/100

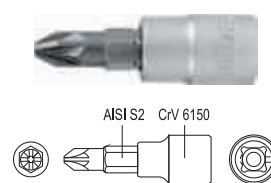
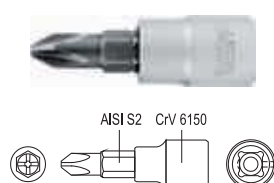

YATO	Ø	⊕	L (mm)	torque / moment obrotowy max. (Nm)	☐
YT-7673	1/4" (6.3 mm)	PH1	37	7.6	10/100
YT-7674	1/4" (6.3 mm)	PH2	37	21.6	10/100
YT-7675	1/4" (6.3 mm)	PH3	37	44.4	10/100

YATO	Ø	⊕	L (mm)	torque / moment obrotowy max. (Nm)	☐
YT-7676	1/4" (6.3 mm)	PZ1	37	6.2	10/100
YT-7677	1/4" (6.3 mm)	PZ2	37	20.1	10/100
YT-7678	1/4" (6.3 mm)	PZ3	37	44.1	10/100

- GB Star bit sockets  
D Aufsteckschlüssel  
PL Klucze trzpieniowe  
RUS Набор головок-вставок  
CZ Čepové klíče  
H Csapkulcs
- RO Chei cu cozi  
F Douille tournevis  
I Chiavi a bussola  
E Llaves de mandril  
CN 星型旋具套筒



SLIDING CARD

3/8"	AISI S2
10mm	
DIN 3120	HRC 58-62

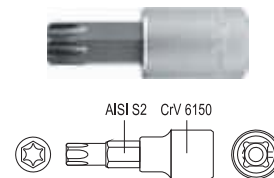

YATO	Ø	☆	L (mm)	torque / moment obrotowy max. (Nm)	☐
YT-7686	3/8" (9.5 mm)	T27	50	34.8	10/100

- GB Star bit sockets  
D Aufsteckschlüssel  
PL Klucze trzpieniowe  
RUS Набор головок-вставок  
CZ Čepové klíče  
H Csapkulcs
- RO Chei cu cozi  
F Douille tournevis  
I Chiavi a bussola  
E Llaves de mandril  
CN 星型旋具套筒



SLIDING CARD

1/2"	AISI S2
12.5mm	
DIN 3120	HRC 58-62

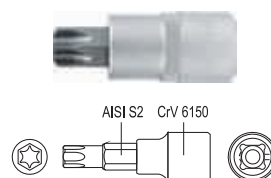
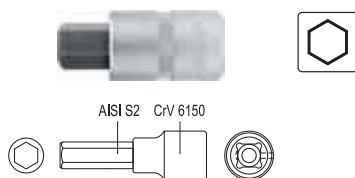

YATO	Ø	⬡	L (mm)	torque / moment obrotowy max. (Nm)	☐
YT-7723	1/2" (12.7 mm)	4	50	26.3	10/100
YT-7724	1/2" (12.7 mm)	5	50	52.7	10/100
YT-7725	1/2" (12.7 mm)	6	50	89.0	10/100
YT-7726	1/2" (12.7 mm)	7	50	128.7	10/100
YT-7727	1/2" (12.7 mm)	8	50	174.1	10/100
YT-7728	1/2" (12.7 mm)	10	50	220.0	10/100
YT-7729	1/2" (12.7 mm)	12	50	370.0	10/100
YT-7730	1/2" (12.7 mm)	14	50	590.0	10/100
YT-7731	1/2" (12.7 mm)	17	50	1000.0	10/100

YATO	Ø	○	L (mm)	torque / moment obrotowy max. (Nm)	☐
YT-7732	1/2" (12.7 mm)	M5	50	33.9	10/100
YT-7733	1/2" (12.7 mm)	M6	50	60.8	10/100
YT-7734	1/2" (12.7 mm)	M8	50	104.2	10/100
YT-7735	1/2" (12.7 mm)	M10	50	176.5	10/100
YT-7736	1/2" (12.7 mm)	M12	50	220.0	10/100
YT-7737	1/2" (12.7 mm)	M14	50	370.0	10/100
YT-7738	1/2" (12.7 mm)	M16	50	590.0	10/100

YATO	Ø	☆	L (mm)	torque / moment obrotowy max. (Nm)	☐
YT-7713	1/2" (12.7 mm)	T20	50	17.9	10/100
YT-7714	1/2" (12.7 mm)	T25	50	25.5	10/100
YT-7715	1/2" (12.7 mm)	T27	50	34.1	10/100
YT-7716	1/2" (12.7 mm)	T30	50	42.6	10/100
YT-7717	1/2" (12.7 mm)	T40	50	76.7	10/100
YT-7718	1/2" (12.7 mm)	T45	50	117.0	10/100
YT-7719	1/2" (12.7 mm)	T50	50	176.5	10/100
YT-7720	1/2" (12.7 mm)	T55	50	218.0	10/100
YT-7721	1/2" (12.7 mm)	T60	50	379.0	10/100
YT-7722	1/2" (12.7 mm)	T70	50	590.0	10/100

GB Star bit sockets RO Chei cu cozi  
 D Aufsteckschlüssel F Douille tournevis  
 PL Klucze trzpieniowe I Chiavi a bussola  
 RUS Набор головок-вставок E Llaves de mandril  
 CZ Čepové klíče CN 星型旋具套筒  
 H Csapkulcs



1/2"  
12.5mm  
DIN 3120  
AISI S2  
HRC 58-62

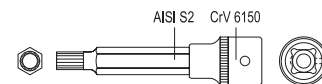
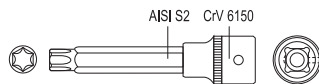
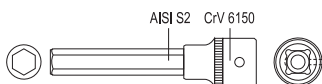

YATO	O	L (mm)	torque / moment obrotowy max. (Nm)	
YT-7739	1/2" (12.7 mm)	4	100	27.5
YT-7740	1/2" (12.7 mm)	5	100	53.4
YT-7741	1/2" (12.7 mm)	6	100	89.4
YT-7742	1/2" (12.7 mm)	7	100	132.2
YT-7743	1/2" (12.7 mm)	8	100	176.3
YT-7744	1/2" (12.7 mm)	10	100	220.0
YT-7745	1/2" (12.7 mm)	12	100	370.0
YT-7746	1/2" (12.7 mm)	14	100	590.0
YT-7747	1/2" (12.7 mm)	17	100	1000.0

YATO	O	L (mm)	torque / moment obrotowy max. (Nm)	
YT-0434	1/2" (12.7 mm)	T20	100	12.7
YT-0441	1/2" (12.7 mm)	T25	100	19.0
YT-0435	1/2" (12.7 mm)	T27	100	26.9
YT-0442	1/2" (12.7 mm)	T30	100	37.4
YT-0436	1/2" (12.7 mm)	T40	100	65.1
YT-0437	1/2" (12.7 mm)	T45	100	104.0
YT-0443	1/2" (12.7 mm)	T50	100	159.0
YT-0438	1/2" (12.7 mm)	T55	100	257.0
YT-0439	1/2" (12.7 mm)	T60	100	446.0
YT-0440	1/2" (12.7 mm)	T70	100	701.0

YATO	O	L (mm)	torque / moment obrotowy max. (Nm)	
YT-0450	1/2" (12.7 mm)	M5	100	16.0
YT-0451	1/2" (12.7 mm)	M6	100	30.0
YT-0452	1/2" (12.7 mm)	M8	100	52.0
YT-0453	1/2" (12.7 mm)	M10	100	120.0
YT-0454	1/2" (12.7 mm)	M12	100	220.0
YT-0455	1/2" (12.7 mm)	M14	100	370.0
YT-0456	1/2" (12.7 mm)	M16	100	590.0
YT-0457	1/2" (12.7 mm)	M17	100	590.0

GB Star bit sockets RO Chei cu cozi  
 D Aufsteckschlüssel F Douille tournevis  
 PL Klucze trzpieniowe I Chiavi a bussola  
 RUS Набор головок-вставок E Llaves de mandril  
 CZ Čepové klíče CN 星型旋具套筒  
 H Csapkulcs



218Nm max.  
DIN 3120  
AISI S2  
HRC 58-62

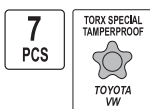

1/4" (6.3 mm): L=35 mm: TS10, TS15, TS20, TS25, TS27, TS30, TS40

1/4" (6.3 mm): L=35 mm: T8, T10, T15, T20, T25, T27, T30  
 3/8" (9.5 mm): L=50 mm: T40, T45, T47, T50, T55

1/4" (6.3 mm): L=35 mm: T8, T10, T15, T20, T25, T27, T30  
 3/8" (9.5 mm): L=50 mm: T40, T45, T47, T50, T55

YATO	YT-0461	12/48
------	---------	-------

YATO	YT-0430	6/48
------	---------	------

YATO	YT-0431	6/48
------	---------	------



1/4" (6.3 mm): L=35 mm: H2, H3, H4, H5, H6  
 3/8" (9.5 mm): L=50 mm: H7, H8, H10, H12

1/4" (6.3 mm): L=35 mm: M5, M6  
 3/8" (9.5 mm): L=50 mm: M8, M10, M12

YATO	YT-0432	6/36
------	---------	------

YATO	YT-0433	12/48
------	---------	-------

GB Bit socket set  
D Aufsteckschlüssel-Satz  
PL Zestaw kluczy trzpieniowych  
RUS Набор головок-вставок

CZ Čepové klíče  
H Csapkulcs  
RO Chei cu cozi  
F Set de douilles tournevis

I Chiavi a bussola a vite  
E Juego de llaves de mandril  
CN 套筒批头组套

BMC  
& COLOR  
SLEEVE



18 PCS	1/2" 12.5mm	1/4" 6.3mm
	CrV 6150	HRC 58-62
	AISI S2	DIN 3120



- 1/4" (6.3 mm): 4, 5, 5, 6.5 mm (L=37 mm); AISI S2 / CrV 6150;
- 1/4" (6.3 mm): PH1, PH2, PH3 (L=37 mm); AISI S2 / CrV 6150;
- 1/2" (12.7 mm): M5, M6, M8, M10, M12, M14 (L=50 mm);  
M5, M6, M8, M10, M12, M14 (L=100 mm); AISI S2 / CrV 6150

YATO	1/2" (12.7 mm)	1/4" (6.3 mm)	10
YT-7750			



- 1/2" (12.7 mm): T30, T40, T45, T50, T55, T60 (L=50 mm);  
T30, T40, T45, T50, T55, T60 (L=100 mm); AISI S2 / CrV 6150;
- 1/4" (6.3 mm): T10, T15, T20, T25, T30, T40 (L=37 mm); AISI S2 / CrV 6150

YATO	1/2" (12.7 mm)	1/4" (6.3 mm)	10
YT-7751			



- 1/2" (12.7 mm): 5, 6, 7, 8, 10, 12 mm (L=50 mm);  
5, 6, 7, 8, 10, 12 mm (L=100 mm); AISI S2 / CrV 6150;
- 1/4" (6.3 mm): 3, 4, 5, 6, 7, 8 mm (L=37 mm); AISI S2 / CrV 6150

YATO	1/2" (12.7 mm)	1/4" (6.3 mm)	10
YT-7752			

GB Bit socket set  
D Aufsteckschlüssel-Satz  
PL Zestaw kluczy trzpieniowych  
RUS Набор головок-вставок

CZ Čepové klíče  
H Csapkulcs  
RO Chei cu cozi  
F Set de douilles tournevis

I Chiavi a bussola a vite  
E Juego de llaves de mandril  
CN 套筒批头组套

BMC  
& COLOR  
SLEEVE



12 PCS	1/2" 12.5mm	CrV 6150
	HRC 58-62	AISI S2
	DIN 3120	



- 1/2" (12.7 mm): M12, M17 (L=50 mm); M6 (L=70 mm); M7, M8 (L=100 mm);  
M8, M10 (L=120 mm); M6, M10, M12 (L=140 mm); M5 (L=180 mm);  
M6 (L=250 mm); AISI S2 / CrV 6150

YATO	1/2" (12.7 mm)	10
YT-7753		

# 3

**Impact sockets,  
accessories & sets**  
**Udarowe klucze nasadowe,  
akcesoria i zestawy**



<b>Impact sockets 3/8"</b> Klucze nasadowe udarowe 3/8"		78
--	---	----

<b>Impact sockets sets</b> Zestawy kluczy nasadowych udarowych krótkich	78
--	----

<b>Impact sockets 1/2"</b> Klucze nasadowe udarowe 1/2"		78-79
--	---	-------

<b>Impact sockets &amp; sets</b> Klucze nasadowe udarowe i zestawy, krótkie	78
<b>Impact sockets, CrV</b> Klucze nasadowe udarowe, krótkie, CrV	78
<b>Deep impact sockets &amp; sets</b> Klucze nasadowe udarowe i zestawy, długie	79
<b>Deep non-slip impact sockets</b> Udarowe nasadki „Non-slip”, długie	79

<b>Impact accessories 1/2"</b> Akcesoria udarowe 1/2"		80
--	---	----

<b>Impact extension bars</b> Przedłużki udarowe	80
<b>Impact adapters</b> Redukcje udarowe	80
<b>Impact universal joints</b> Przeguby kuliste udarowe	80

<b>Impact sockets 3/4"</b> Udarowe klucze nasadowe 3/4"		81-82
--	---	-------

<b>Impact sockets &amp; sets</b> Klucze nasadowe udarowe i zestawy, krótkie	81
<b>Deep impact sockets &amp; sets</b> Klucze nasadowe udarowe i zestawy, długie	81

<b>Impact accessories 3/4"</b> Akcesoria udarowe 3/4"		82
--	---	----

<b>Impact extension bars</b> Przedłużki udarowe	82
<b>Impact adapters</b> Redukcje udarowe	82
<b>Impact universal joints</b> Przeguby kuliste udarowe	82

<b>Impact sockets 1"</b> Udarowe klucze nasadowe 1"		83
--	---	----

<b>Impact sockets</b> Klucze nasadowe udarowe, krótkie	83
<b>Deep impact sockets</b> Klucze nasadowe udarowe, długie	83

<b>Impact accessories 1"</b> Akcesoria udarowe 1"		83
--	---	----

<b>Impact extension bars with adapter</b> Przedłużki udarowe z redukcją	83
--	----

<b>Impact sockets for front hub nuts</b> Nasadki udarowe do piast		84
--	---	----

<b>Impact bit socket sets 1/2"</b> Zestawy udarowych kluczy trzpieniowych 1/2"		84
---	---	----

<b>Spline impact bit sets 3/4"</b> Zestawy bitów udarowych „Spline” 3/4"		84
---	---	----

GB Impact socket set  
D Kraftschrauber-Einsatz  
PL Zestaw nasadek udarowych  
RUS Набор торцевых ударных головок

CZ Sada nástrčných klíčů pro úderové utahováký  
H Dugófej készlet ütvebehajtóhoz  
RO Set chei tubulare pt. impact  
F Douille profonde à choc

I Chiave a bussola esagonale per percussione  
E Juego de boquillas de percusión cortas  
CN 风动套筒组套

METAL CASE & COLOR BOX



10 PCS 3/8" 10mm

CrMo SCM-440



3/8" (9.5 mm): 10, 12, 13, 14, 15, 16, 17, 18, 19, 22 mm (L=39 mm)

<b>YATO</b>		
YT-37690	3/8" (9.5 mm)	20

GB Hexagonal impact socket  
D Kraftschrauber-Einsatz  
PL Nasadka udarowa sześciokątna  
RUS Головка ударная 6-гранная  
CZ Šestihranný nástavec  
H Hatszögű rátét  
RO Cheie tubulară hexagonală de impact  
F Douille à choc  
I Chiave a bussola esagonale per percussione  
E Boquilla de percusión  
CN 六角风动套筒

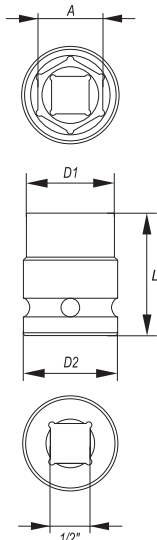

COLOR BOX



1/2" 12.5mm

CrMo SCM-440

AS-DRIVE

YATO	∅ A (mm)	D1 (mm)	D2 (mm)	L (mm)	PCS packing	
YT-1000	10	17.5	25.0	39	60	240
YT-1001	11	18.5	25.0	39	60	240
YT-1002	12	20.0	25.0	39	60	240
YT-1003	13	21.0	25.0	39	60	240
YT-1004	14	22.5	25.0	39	60	240
YT-1005	15	23.5	30.0	39	40	160
YT-1006	16	24.0	30.0	39	40	160
YT-1007	17	26.0	30.0	39	40	160
YT-1008	18	27.5	30.0	39	40	160
YT-1009	19	28.0	30.0	39	40	160
YT-1010	20	30.0	30.0	39	40	160
YT-1011	21	30.0	30.0	39	40	160
YT-1012	22	32.0	30.0	39	30	120
YT-1013	23	32.0	30.0	39	30	120
YT-1014	24	34.0	30.0	43	30	120
YT-1015	25	35.0	30.0	43	30	120
YT-1016	26	38.0	30.0	43	24	96
YT-1017	27	38.0	30.0	43	24	96
YT-1018	28	40.0	30.0	48	24	96
YT-1019	29	41.0	30.0	48	22	88
YT-1020	30	42.0	30.0	48	24	96
YT-1022	32	44.0	30.0	48	20	80

GB Impact socket set  
D Kraftschrauber-Einsatz  
PL Zestaw nasadek udarowych  
RUS Набор торцевых ударных головок

CZ Sada nástrčných klíčů pro úderové utahováký  
H Dugófej készlet ütvebehajtóhoz  
RO Set chei tubulare pt. impact  
F Set de douilles à choc

I Chiave a bussola esagonale per percussione  
E Juego de boquillas de percusión cortas  
CN 风动套筒组套

METAL CASE & COLOR BOX



10 PCS 1/2" 12.5mm

CrMo SCM-440

AS-DRIVE



1/2" (12.7 mm): 10, 12, 13, 14, 15, 16, 17, 18, 19, 22 mm (L=39 mm)

<b>YATO</b>		
YT-1025	1/2" (12.7 mm)	20

GB Hexagonal impact socket  
D Kraftschrauber-Einsatz  
PL Nasadka udarowa sześciokątna  
RUS Головка ударная 6-гранная  
CZ Šestihranný nástavec  
H Hatszögű rátét  
RO Cheie tubulară hexagonală de impact  
F Douille à choc  
I Chiave a bussola esagonale per percussione  
E Boquilla de percusión  
CN 六角风动套筒

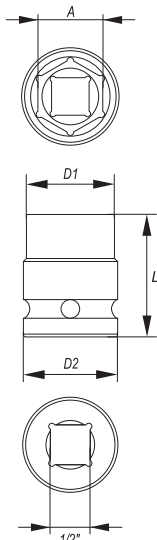

COLOR BOX



1/2" 12.5mm

CrV

AS-DRIVE

YATO	∅ A (mm)	D1 (mm)	D2 (mm)	L (mm)	PCS packing	
YT-1781	9	15.5	24.0	38	12	240
YT-1792	20	30.0	30.0	38	12	144
YT-1795	23	34.0	34.0	40	12	96
YT-1797	27	37.5	37.5	41	10	80
YT-1799	32	44.0	44.0	44	10	80

- GB Hexagonal deep impact socket  
D Kraftschrauber-Einsatz, lang  
PL Nasadka udarowa sześciokątna długa  
RUS Головка ударная 6-гранная глубокая  
CZ Šestihranný hluboký nástavec  
H Hatszögű rátét mély  
RO Cheie tubulară hexagonală de impact adâncă  
F Douille profonde à choc  
I Chiave a bussola esagonale per percussione  
E Boquilla de percusión profunda  
CN 六角风动长套筒

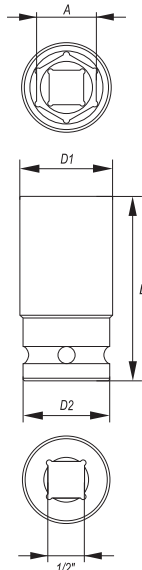

COLOR BOX



1/2"  
12.5mm

CrMo  
SCM-440

AS-DRIVE

YATO	∅ A (mm)	D1 (mm)	D2 (mm)	L (mm)	PCS packing:	
YT-1030	10	17.5	24.0	78	30	120
YT-1031	11	18.5	24.0	78	30	120
YT-1032	12	20.0	24.0	78	30	120
YT-1033	13	21.0	24.0	78	30	120
YT-1034	14	22.0	24.0	78	30	120
YT-1035	15	23.7	24.0	78	30	120
YT-1036	16	24.0	24.0	78	30	120
YT-1037	17	26.0	26.0	78	25	100
YT-1038	18	28.0	28.0	78	24	96
YT-1039	19	28.0	28.0	78	24	96
YT-1040	20	30.0	30.0	78	20	80
YT-1041	21	30.0	30.0	78	20	80
YT-1042	22	32.0	30.0	78	18	72
YT-1043	23	32.0	30.0	78	15	60
YT-1044	24	34.0	30.0	78	15	60
YT-1045	25	35.0	30.0	78	15	60
YT-1046	26	38.0	30.0	78	12	48
YT-1047	27	38.0	30.0	78	12	48
YT-1048	28	40.0	30.0	78	12	48
YT-1049	29	41.0	30.0	78	10	40
YT-1050	30	42.0	30.0	78	10	40
YT-1052	32	44.0	30.0	78	10	40

- GB Impact socket set  
D Kraftschrauber-Einsätze  
PL Zestaw nasadek udarowych  
RUS Набор торцевых ударных головок  
CZ Sada nástrčných klíčů pro úderové utahováky  
H Dugófej készlet ütvebehajtóhoz

- RO Set chei tubulare pt. impact  
F Set de douilles à choc  
I Chiave a bussola esagonale per percussione  
E Juego de boquillas de percusión cortas  
CN 风动套筒组套

METAL CASE & COLOR BOX



1/2"  
12.5mm

CrMo  
SCM-440

AS-DRIVE



11  
PCS

1/2" (12.7 mm): 10, 12, 13, 14, 15, 16, 17, 18, 19, 22, 24 mm (L=39 mm)

15  
PCS

1/2" (12.7 mm): 10, 12, 13, 14, 15, 16, 17, 18, 19, 21, 22, 24, 27, 30, 32 mm (L=39 mm)

YATO	∅	
YT-1054	1/2" (12.7 mm)	10

YATO	∅	
YT-1055	1/2" (12.7 mm)	4

- GB Hexagonal deep impact socket NON-SLIP  
D Kraftschrauber-Einsatz, lang NON-SLIP  
PL Nasadka udarowa sześciokątna długa NON-SLIP  
RUS Головка ударная 6-гранная глубокая NON-SLIP  
CZ Šestihranný hluboký nástavec NON-SLIP  
H Hatszögű rátét mély NON-SLIP  
RO Cheie tubulară hexagonală de impact adâncă NON-SLIP  
F Douille à choc NON-SLIP longue  
I Chiave a bussola esagonale lunga  
E Boquilla de percusión profunda NON-SLIP  
CN 风动防滑长套筒

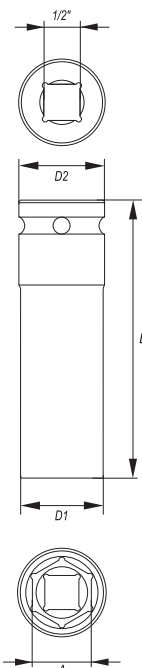

PLASTIC HANGER

COLOR BOX



10 PCS



1/2"  
12.5mm

CrMo  
SCM-440

NON-SLIP  
SYSTEM

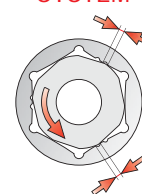

YATO	∅ A (mm)	D1 (mm)	D2 (mm)	L (mm)	PCS packing:	
YT-1588	10	12.40	19.55	80	10	160
YT-1589	11	18.90	19.60	80	10	160
YT-1590	12	19.90	24.62	80	10	160
YT-1591	13	20.95	24.70	80	10	160
YT-1592	14	22.88	24.74	80	10	160
YT-1593	15	23.85	24.63	80	10	120
YT-1594	16	24.64	24.64	80	10	120
YT-1596	18	27.90	29.78	80	10	100
YT-1598	21	31.70	29.90	80	10	80
YT-1599	24	34.75	30.10	80	10	80

- GB Impact extension bar
- D Verlängerung
- PL Przedłużka udarowa
- RUS Удлинитель ударный
- CZ Prodlužovací příravek
- H Toldalék
- RO Prelungitor
- F Rallonge
- I Prolunga per percussione
- E Tubo de prolongación
- CN 风动接杆

**1/2"**  
**12.5mm** CrMo SCM-440



COLOR BOX



YATO	Ø	D1 (mm)	D2 (mm)	L (mm)	PCS packing	
YT-1060	1/2" (12.7 mm)	17.5	25.0	75	40	160
YT-1061	1/2" (12.7 mm)	18.5	25.0	125	28	112
YT-1062	1/2" (12.7 mm)	20.0	25.0	250	30	60

- GB Impact adapter
- D Reduktion
- PL Redukcja udarowa
- RUS Переходник
- CZ Redukce
- H Redukció
- RO Reducție
- F Réduction
- I Prolunga per percussione
- E Reducción
- CN 风动转换头

**1/2"**  
**12.5mm** CrMo SCM-440



COLOR BOX



YATO	Ø	Ø	D (mm)	L (mm)	PCS packing	
YT-1067	1/2" (12.7 mm) (F)	3/4" (19.0 mm) (M)	30	48	40	160

- GB Impact universal joint
- D Gelenkstück
- PL Przegub kulisty udarowy
- RUS Кардан ударный
- CZ Kloub kulový
- H Univerzális csuklós csatlakozó
- RO Adaptor
- F Flector rond
- I Prolunga per percussione
- E Articulación redonda
- CN 风动万向接头

**1/2"**  
**12.5mm** CrMo SCM-440



COLOR BOX



YATO	Ø	D1 (mm)	D2 (mm)	L (mm)	PCS packing	
YT-1064	1/2" (12.7 mm)	31	17	63	25	100



- GB Hexagonal impact socket  
D Kraftschrauber-Einsatz  
PL Nasadka udarowa sześciokątna  
RUS Головка ударная 6-гранная  
CZ Šestihranný nástavec  
H Hatszögű rátét  
RO Cheie tubulară hexagonală de impact  
F Douille à choc  
I Chiave a bussola esagonale per percussione  
E Boquilla de percusión  
CN 六角风动套筒

COLOR BOX



3/4"  
19mm  
CrMo  
SCM-440  
AS-DRIVE

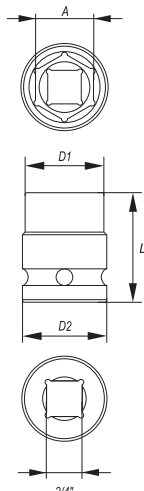

YATO	∅ A (mm)	D1 (mm)	D2 (mm)	L (mm)	PCS packing:	
YT-1070	19	32	40	50	16	64
YT-1071	21	35	40	50	16	64
YT-1072	22	38	40	50	16	64
YT-1073	23	38	40	50	16	64
YT-1074	24	40	40	50	16	64
YT-1075	25	40	40	50	16	64
YT-1076	26	40	40	50	16	64
YT-1077	27	42	42	53	16	64
YT-1078	28	44	44	53	16	64
YT-1079	29	46	44	53	12	48
YT-1080	30	46	44	53	12	48
YT-1082	32	48	44	56	12	48
YT-1083	33	48	44	56	8	32
YT-1084	34	50	44	56	8	32
YT-1085	35	50	44	56	6	24
YT-1086	36	52	44	56	6	24
YT-1088	38	56	44	57	6	24
YT-1091	41	60	44	57	5	20
YT-1092	42	61	44	57	4	16
YT-1093	43	63	44	57	4	16
YT-1096	46	66	44	62	3	12
YT-1098	48	68	44	67	3	12
YT-1100	50	71	54	72	3	12
YT-1102	52	74	54	72	2	8
YT-1105	55	78	54	74	2	8
YT-1110	60	84	54	74	2	8

- GB Impact socket set  
D Kraftschrauber-Einsätze  
PL Zestaw nasadek udarowych  
RUS Набор торцевых ударных головок  
CZ Sada nástrčných klíčů pro úderové utahováky  
H Dugófej készlet ütvebehajtóhoz
- RO Set chei tubulare pt. impact  
F Set de douilles à choc  
I Chiave a bussola esagonale per percussione  
E Juego de boquillas de percusión cortas  
CN 风动套筒组套



METAL CASE & COLOR BOX

8  
PCS  
3/4"  
19mm  
CrMo  
SCM-440  
AS-DRIVE



3/4" (19.0 mm): 22, 24 mm (L=50 mm); 27, 30 mm (L=53 mm);  
32, 36 mm (L=55 mm); 38, 41 mm (L=57 mm)

YATO	∅	
YT-1115	3/4" (19.0 mm)	6

- GB Hexagonal deep impact socket  
D Kraftschrauber-Einsatz, lang  
PL Nasadka udarowa sześciokątna długa  
RUS Головка ударная 6-гранная глубокая  
CZ Šestihranný hluboký nástavec  
H Hatszögű rátét mély  
RO Cheie tubulară hexagonală de impact adâncă
- F Douille profonde à choc  
I Chiave a bussola esagonale per percussione  
E Boquilla de percusión profunda  
CN 六角风动长套筒

COLOR BOX



3/4"  
19mm  
CrMo  
SCM-440  
AS-DRIVE

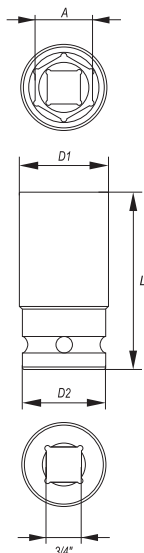

YATO	∅ A (mm)	D1 (mm)	D2 (mm)	L (mm)	PCS packing:	
YT-1119	19	32	44	90	9	36
YT-1121	21	35	44	90	9	36
YT-1122	22	38	44	90	9	36
YT-1123	23	38	44	90	9	36
YT-1124	24	40	44	90	9	36
YT-1125	25	40	44	90	9	36
YT-1127	27	42	44	90	9	36
YT-1128	28	44	44	90	8	32
YT-1129	29	44	44	90	8	32
YT-1130	30	46	44	90	7	28
YT-1132	32	48	44	90	7	28
YT-1133	33	50	44	90	6	24
YT-1134	34	51	44	90	6	24
YT-1135	35	52	44	90	6	24
YT-1136	36	54	44	90	6	24
YT-1138	38	56	44	90	6	24
YT-1141	41	60	44	90	5	20
YT-1142	42	61	44	90	4	16
YT-1143	43	63	44	90	3	12
YT-1146	46	66	44	90	3	12
YT-1148	48	68	44	90	2	8
YT-1150	50	71	54	90	2	8

GB Impact socket set  
D Kraftschrauber-Einsätze  
PL Zestaw nasadek udarowych  
RUS Набор торцевых ударных головок

CZ Sada nástrčných klíčů pro úderové utahovky  
H Dugófej készlet ütvebehajtóhoz  
RO Set chei tubulare pt. impact  
F Douille profonde à choc

I Chiave a bussola esagonale per percussione  
E Juego de boquillas de percusión cortas  
CN 风动长套筒组套



8 PCS  
3/4" 19mm  
CrMo SCM-440  
AS-DRIVE



3/4" (19.0 mm): 22, 24, 27, 30, 32, 36, 38, 41 mm (L=90 mm)

<b>YATO</b>	○	
YT-1155	3/4" (19.0 mm)	4

GB Impact extension bar  
D Verlängerung  
PL Przedłużka udarowa  
RUS Удлинитель ударный  
CZ Prodlužovací přípravek  
H Toldalék  
RO Prelungitor  
F Rallonge  
I Prolunga per percussione  
E Tubo de prolongación  
CN 风动接杆

3/4" 19mm  
CrMo SCM-440

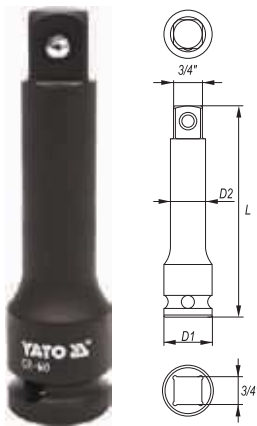

COLOR BOX



YATO	○	D1 (mm)	D2 (mm)	L (mm)	PCS packing:	
YT-1160	3/4" (19.0 mm)	44	24	100	8	32
YT-1161	3/4" (19.0 mm)	44	24	175	10	20
YT-1162	3/4" (19.0 mm)	44	24	250	8	16
YT-1163	3/4" (19.0 mm)	44	24	330	6	12

GB Impact adapter  
D Reduktion  
PL Redukcja udarowa  
RUS Переходник  
CZ Redukce  
H Redukció  
RO Reducție

F Réduction  
I Prolunga per percussione  
E Reducción  
CN 风动转换头

3/4" 19mm  
CrMo SCM-440

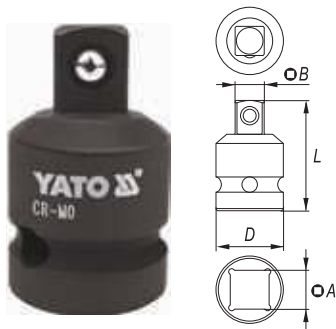

COLOR BOX



YATO	○	○	D (mm)	L (mm)	PCS packing:	
YT-1168	3/4" (19.0 mm) (F)	1" (25.4 mm) (M)	44	63	12	48

GB Impact adapter  
D Reduktion  
PL Redukcja udarowa  
RUS Переходник  
CZ Redukce  
H Redukció  
RO Reducție

F Réduction  
I Prolunga per percussione  
E Reducción  
CN 风动转换头

3/4" 19mm  
CrV 50BV30



COLOR BOX



YATO	○	○	D (mm)	L (mm)	PCS packing:	
YT-11671	3/4" (19.0 mm) (F)	1/2" (12.7 mm) (M)	44	55	12	48

GB Impact universal joint  
D Gelenkstück  
PL Przegub kulisty udarowy  
RUS Кардан ударный  
CZ Kloub kulový  
H Univerzális csuklós csatlakozó  
RO Adaptor  
F Flector rond  
I Prolunga per percussione  
E Articulación redonda  
CN 风动方向接头

3/4" 19mm  
CrMo SCM-440



COLOR BOX



YATO	○	D1 (mm)	D2 (mm)	L (mm)	PCS packing:	
YT-1164	3/4" (19.0 mm)	31	44	102	8	32

- GB Hexagonal impact socket  
D Kraftschrauber-Einsatz  
PL Nasadka udarowa sześciokątna  
RUS Головка ударная 6-гранная  
CZ Šestihranný nástavec  
H Hatszögű rátét  
RO Cheie tubulară hexagonală de impact  
F Douille à choc  
I Chiave a bussola esagonale per percussione  
E Boquilla de percusión  
CN 六角风动套筒

COLOR BOX



1"  
25 mm

CrMo  
SCM-440

AS-DRIVE

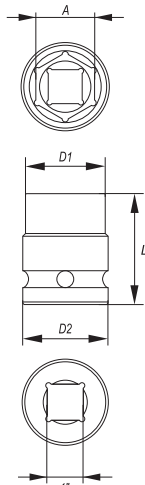

YATO	∅ A (mm)	D1 (mm)	D2 (mm)	L (mm)	PCS packing	
YT-1180	24	42	54	59	6	24
YT-1182	26	43	54	59	6	24
YT-1183	27	46	54	59	6	24
YT-1184	28	47	54	59	6	24
YT-1185	29	48	54	60	6	24
YT-1186	30	49	54	60	6	24
YT-1187	32	52	54	61	6	24
YT-1188	33	53	54	61	6	24
YT-1189	34	54	54	61	6	24
YT-1191	36	57	54	65	6	24
YT-1193	38	60	54	65	5	20
YT-1194	41	63	54	65	4	16
YT-1195	43	65	54	68	4	16
YT-1196	46	69	54	73	3	12
YT-1197	48	72	54	73	2	8
YT-1198	50	75	54	73	2	8

- GB Hexagonal deep impact socket  
D Kraftschrauber-Einsatz, lang  
PL Nasadka udarowa sześciokątna długa  
RUS Головка ударная 6-гранная глубокая  
CZ Šestihranný hluboký nástavec  
H Hatszögű rátét mély  
RO Cheie tubulară hexagonală de impact adâncă  
F Douille profonde à choc  
I Chiave a bussola esagonale per percussione  
E Boquilla de percusión profunda  
CN 六角风动长套筒

COLOR BOX



1"  
25 mm

CrMo  
SCM-440

AS-DRIVE

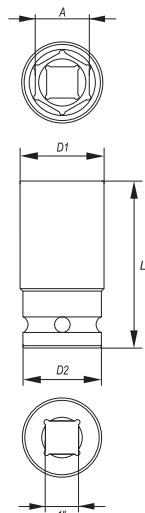

YATO	∅ A (mm)	D1 (mm)	D2 (mm)	L (mm)	PCS packing	
YT-1175	27	46	54	90	6	24
YT-1176	30	50	54	90	6	24
YT-1177	32	52	54	90	6	24
YT-1178	33	54	54	90	6	24
YT-1179	36	57	54	90	6	24

- GB Impact extension bar with adapter  
D Verlängerung mit Adapter  
PL Przedłużka udarowa z redukcją  
RUS Удлинитель с редукцией  
CZ Prodloužení s redukcí  
H Hosszabbító szár adapterrel  
RO Bara extensie cu adaptor  
F Rallonge avec reduction  
I Prolunga per percussione con riduttore  
E Tubo de prolongación con reductor  
CN 风动转换接头

COLOR BOX



1"  
25 mm

CrMo  
SCM-440

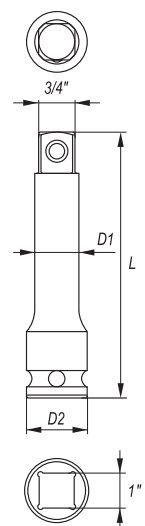

YATO	∅ A	∅ B	D1 (mm)	D2 (mm)	L (mm)	PCS packing	
YT-1169	1" (25.4 mm) (F)	3/4" (19.0mm) (M)	53	33	250	6	12

GB Hexagonal impact socket  
 D Kraftschrauber-Einsatz  
 PL Nasadka uderowa sześciokątna  
 RUS Головка ударная 6-гранная  
 CZ Šestihřanný nástavec  
 H Hatszögű rátét  
 RO Cheie tubulară hexagonală de impact  
 F Douille à choc  
 I Chiave a bussola esagonale per percussione  
 E Boquilla de percusión  
 CN 六角风动套筒

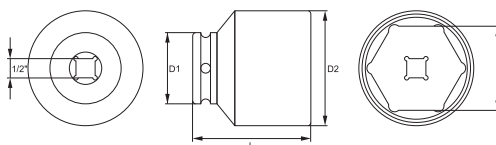

COLOR BOX



1/2"  
12.5mm

FOR FRONT HUB NUTS DO PIAST

CrMo SCM-440

AS-DRIVE

YATO	Ø A (mm)	D1 (mm)	D2 (mm)	L (mm)	PCS packing	
YT-1029	52	44	71	72	3	12

GB Bi-hexagonal impact socket  
 D Zwölfkant-Kraftschrauber-Einsatz  
 PL Nasadka uderowa dwunastokątna  
 RUS Головка ударная 12-гранная  
 CZ Vanáctihřanný nástavec  
 H Dugófej, 12 lapú  
 RO Cheie tubulară bihexagonală de impact  
 F Douille à choc  
 I Chiave a bussola esagonale per percussione  
 E Boquilla bihexagonal de percusión  
 CN 风动套筒

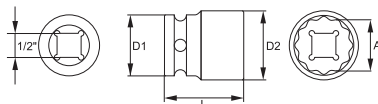

COLOR BOX



1/2"  
12.5mm

FOR FRONT HUB NUTS DO PIAST

CrMo SCM-440

AS-DRIVE

YATO	Ø A (mm)	D1 (mm)	D2 (mm)	L (mm)	PCS packing	
YT-1027	24	30	34	39	10	120

GB Bi-hexagonal deep impact socket  
 D Zwölfkant-Kraftschrauber-Einsatz, lang  
 PL Nasadka uderowa dwunastokątna długa  
 RUS Головка ударная 12-гранная глубокая  
 CZ Vanáctihřanný hluboký nástavec  
 H Dugófej, mély, 12 lapú  
 RO Cheie tubulară bihexagonală de impact adâncă  
 F Douille à choc  
 I Chiave a bussola esagonale per percussione  
 E Boquilla bihexagonal de percusión profunda  
 CN 风动套筒

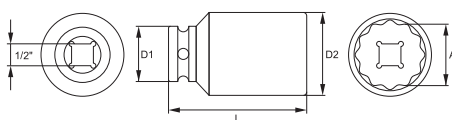

COLOR BOX



1/2"  
12.5mm

FOR FRONT HUB NUTS DO PIAST

CrMo SCM-440

AS-DRIVE

YATO	Ø A (mm)	D1 (mm)	D2 (mm)	L (mm)	PCS packing	
YT-1028	33	30	45	75	8	32

GB Impact bit socket set  
 D Schlagsteckschlüsselsatz  
 PL Zestaw uderowych kluczy trzpieniowych  
 RUS Набор ударных торцовых ключей

CZ Souprava rázových zástrčných klíčů  
 H Űthető dugókulcs bit - készlet  
 RO Set chei de șoc cu bolt  
 F Set de douilles à choc

I Set di chiavi a bussola per percussione  
 E Juego de llaves de mandril de impacto  
 CN 风动套筒批头组套

BMC & COLOR SLEEVE



8 PCS

1/2"  
12.5mm

CrMo

HRC 54



T30, T40, T45, T50, T55, T60, T70, T80

6, 7, 8, 10, 12, 14, 17, 19 mm  
HEX

YATO	Ø	
YT-1065	1/2" (12.7 mm)	15

YATO	Ø	
YT-1066	1/2" (12.7 mm)	15



RMS, RM6, RM7, RM8, RM10, RM11, RM12, RM13

M5, M6, M8, M10, M12, M14, M16, M18  
SPLINE

YATO	Ø	
YT-1068	1/2" (12.7 mm)	15

YATO	Ø	
YT-1069	1/2" (12.7 mm)	15

GB Spline impact bit set  
 D Schlagwerkzeugsatz - Spline  
 PL Zestaw bitów uderowych - Spline  
 RUS Набор ударных битов - Spline  
 CZ Souprava bitů pro rázové utahováky - Spline  
 H Űtő bit készlet - Spline  
 RO Set tubulare de impact  
 F Set d'embouts à choc  
 I Set di chiavi a bussola per percussione Spline  
 E Juego de las piezas de percusión - Spline  
 CN 风动花键批头组套



BMC & COLOR BOX



6 PCS

3/4"  
19mm

SPLINE (XZN)

CrMo

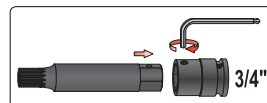

M12, M14, M16, M18 x 22 mm; (L=107 mm); CrMo;  
 3/4" (19.0 mm) x 22 mm; CrMo;

YATO	Ø	
YT-1157	3/4" (19.0 mm)	8

Memo

# 4

## Torque wrenches & torque multipliers Klucze dynamometryczne i wzmacniacze momentu



Torque wrenches

Klucze dynamometryczne

88



Torque angle gauges

Kątomierze do dokręcania śrub

89



Torque wrenches with metal handle

Klucze dynamometryczne z metalową rączką

88

Torque wrenches with plastic handle

Klucze dynamometryczne z plastikową rączką

88

Torque multipliers

Wzmacniacze momentu

89



GB Torque wrench  
D Drehmomentschlüssel  
PL Klucz dynamometryczny  
RUS Ключ динамометрический

CZ Dynamometrický klíč  
H Nyomatékkulcs  
RO Cheie cu dinamometru  
F Clé dynamométrique

I Chiave dinamometrica  
E Llave dinamométrica  
CN 传统型可调式扭力扳手



**1/2"**  
12.5mm

**3/8"**  
10mm

**CrV**  
6140



BMC

YATO 	Ø	Nm	L (mm)	
YT-0750	3/8" (9.5 mm)	20-110	366	20
YT-0760	1/2" (12.7 mm)	42-210	470	12

4

GB Torque wrench  
D Drehmomentschlüssel  
PL Klucz dynamometryczny  
RUS Ключ динамометрический

CZ Dynamometrický klíč  
H Nyomatékkulcs  
RO Cheie cu dinamometru  
F Clé dynamométrique

I Chiave dinamometrica  
E Llave dinamométrica  
CN 传统型可调式扭力扳手

**3/4"**  
19mm

**1/2"**  
12.5mm

**CrV**  
6140





BMC

YT-0771

- application: automotive service stations, trucks
- wrench and extension pipe designed to tighten screws in double wheels
- measurement tolerance +/- 3%

YT-0771

- przeznaczenie: serwis, samochody ciężarowe
- łącznie z przedłużką dostosowany do dokręcania śrub w kołach bliźniaczych
- dokładność pomiarowa +/- 3 %

YATO 	Ø	Nm	L (mm)	
YT-0761	1/2" (12.7 mm)	40-210	535	10
YT-0770	3/4" (19.0 mm)	100-500	865	4
YT-0771	3/4" (19.0 mm)	140-980	1230	2

GB Torque wrench  
D Drehmomentschlüssel  
PL Klucz dynamometryczny  
RUS Ключ динамометрический

CZ Dynamometrický klíč  
H Nyomatékkulcs  
RO Cheie cu dinamometru  
F Clé dynamométrique

I Chiave dinamometrica  
E Llave dinamométrica  
CN 传统型可调式扭力扳手

**1/4"**  
6.3mm

**CrV**  
6140



BMC

YATO 	Ø	Nm	L (mm)	
YT-0751	1/4" (6.3 mm)	2-10	281	24

GB Torque wrench  
D Drehmomentschlüssel  
PL Klucz dynamometryczny  
RUS Ключ динамометрический

CZ Dynamometrický klíč  
H Nyomatékkulcs  
RO Cheie cu dinamometru  
F Clé dynamométrique

I Chiave dinamometrica  
E Llave dinamométrica  
CN 传统型可调式扭力扳手



**3/4"**  
19mm

**1/2"**  
12.5mm

**CrV**  
6140



BMC

YATO 	Ø	Nm	L (mm)	
YT-0754	1/2" (12.7 mm)	60-340	613	10
YT-0755	3/4" (19.0 mm)	200-1000	1234	2



# Torque wrenches & torque multipliers Klucze dynamometryczne i wzmacniacze momentu



- GB Torque angle gauge
- D Winkelmesser zum Anziehen von Schrauben
- PL Kątomierz do dokręcania śrub
- RUS Угломер для подвёртывания болтов
- CZ Úhloměr k utahování šroubů
- H Nyomaték szögmérő
- RO Raportor pt. înşurubat şuruburi
- F Rapporteur à serrer les vis
- I Goniometro per il serraggio controllo
- E Calibrador para apretar tornillos
- CN 扭力角度规



1/2"  
12.5mm 360° CrV



SLIDING CARD

<b>YATO</b>		
YT-0593		12/48

4

- GB Torque multiplier
- CZ Mechanický posilovač momentu
- I Moltiplicatore di coppia
- D Drehmomentverstärker
- H Nyomaték sokszorozó
- E Mecanismo de reforzar el momento
- PL Mechaniczny wzmacniacz momentu
- RO Antrenor cu amplificator de forta
- CN 3倍扭力倍增器
- RUS Мультипликатор крутящего момента
- F Amplificateur de couple mécanique

3/4" max. 900 Nm 1" max. 2700 Nm 3:1 CrMo 4140

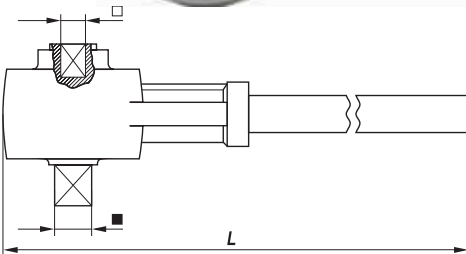

BMC & COLOR SLEEVE

<b>YATO</b>	F	Tmax. (Nm)	M	Tmax. (Nm)	L (mm)	
YT-0781	3/4" (19.0 mm)	900	1" (25.4 mm)	2700	500	4

- GB Labor save wrench
- D Drehmomentverstärker
- PL Mechaniczny wzmacniacz momentu
- RUS Механический усилитель силы
- CZ Mechanický posilovač momentu
- H Nyomaték sokszorozó
- RO Antrenor cu amplificator de forta
- F Amplificateur de couple mécanique
- I Moltiplicatore di coppia
- E Mecanismo de reforzar el momento
- CN 扭力倍增器

1" 25mm 32,33mm 4200 Nm (max) 1-1:3.8 II-1:58 CrV

- GB Labor save wrench
- D Drehmomentverstärker
- PL Mechaniczny wzmacniacz momentu
- RUS Механический усилитель силы
- CZ Mechanický posilovač momentu
- H Nyomaték sokszorozó
- RO Antrenor cu amplificator de forta
- F Amplificateur de couple mécanique
- I Moltiplicatore di coppia
- E Mecanismo de reforzar el momento
- CN 扭力倍增器

1" 25mm 32,33mm 5800 Nm (max) 1:66 CrV



BMC & COLOR SLEEVE



<b>YATO</b>	Ø	Nm	L (mm)	
YT-0782	1" (25.4 mm)	4200	330	1



BMC & COLOR SLEEVE



<b>YATO</b>	Ø	Nm	L (mm)	
YT-07822	1" (25.4 mm)	5800	380	1

# 5

## Screwdrivers & screwdriver bits Wkrętaki i końcówki wkrętakowe



Screwdrivers, 2 color handle  
Wkrętaki, dwukolorowa rączka

92-96



Slotted screwdrivers Wkrętaki płaskie.....	92
Phillips screwdrivers Wkrętaki krzyżakowe.....	92
Pozidrive screwdrivers Wkrętaki „Pozidrive”.....	92
Torx screwdrivers Wkrętaki „Torx”.....	92
Torx Security screwdrivers Wkrętaki „Torx Security”.....	92
Slotted screwdrivers with straight tip Wkrętaki płaskie z wąskim grotem.....	93
Go-through screwdrivers Wkrętaki do pobijania.....	93
Screwdriver sets Komplety wkrętaków.....	93
Precision screwdriver sets Zestawy wkrętaków precyzyjnych.....	96

Screwdrivers, 3 color handle  
Wkrętaki, trój kolorowa rączka

97-100



Slotted screwdrivers Wkrętaki płaskie.....	97
Phillips screwdrivers Wkrętaki krzyżakowe.....	97
Pozidrive screwdrivers Wkrętaki „Pozidrive”.....	97
Torx screwdrivers Wkrętaki „Torx”.....	97
Torx Security screwdrivers Wkrętaki „Torx Security”.....	97
Go-through screwdrivers Wkrętaki do pobijania.....	98
Screwdriver sets Komplety wkrętaków.....	98

Screwdrivers, 3 color handle  
Wkrętaki, trój kolorowa rączka

101-102



Slotted screwdrivers Wkrętaki płaskie.....	101
Phillips screwdrivers Wkrętaki krzyżakowe.....	101
Pozidrive screwdrivers Wkrętaki „Pozidrive”.....	101
Torx screwdrivers Wkrętaki „Torx”.....	101
Torx Security screwdrivers Wkrętaki „Torx Security”.....	101
Screwdriver sets Komplety wkrętaków.....	102

Precision screwdrivers, 3 color handle  
Wkrętaki precyzyjne, trój kolorowa rączka

103



Precision slotted screwdrivers Wkrętaki precyzyjne płaskie.....	103
Precision phillips screwdrivers Wkrętaki precyzyjne krzyżakowe.....	103
Precision Pozidrive screwdrivers Wkrętaki precyzyjne „Pozidrive”.....	103
Precision Torx screwdrivers Wkrętaki precyzyjne „Torx”.....	103

Precision screwdriver sets Zestawy wkrętaków precyzyjnych.....	103
---	-----

Insulated screwdrivers  
Wkrętaki izolowane

104



Insulated slotted screwdrivers Wkrętaki izolowane płaskie.....	104
Insulated phillips screwdrivers Wkrętaki izolowane krzyżakowe.....	104
Insulated Pozidrive screwdrivers Wkrętaki izolowane „Pozidrive”.....	104
Insulated screwdriver sets Komplety wkrętaków izolowanych.....	104

Special screwdrivers & impact screwdrivers  
Wkrętaki specjalne i udarowe

105-107



Ratchet screwdriver sets Wkrętaki z grzechotką.....	105
Impact screwdrivers Wkrętaki udarowe.....	107

Screwdriver bits  
Końcówki wkrętakowe

108-112



Phillips screwdriver bits Końcówki wkrętakowe krzyżakowe.....	108
Torx screwdriver bits Końcówki wkrętakowe „Torx”.....	108
YATO NON-SLIP SYSTEM screwdriver bits Końcówki wkrętakowe „YATO NON-SLIP SYSTEM”.....	108
Screwdriver bit sets Zestawy końcówek wkrętakowych.....	108

Nut setters  
Nasadki magnetyczne do wkrętarek

113



Screwdriver bit holders  
Uchwyty do końcówek wkrętakowych

113



Hex & Torx keys & sets  
Klucze imbusowe i zestawy

113-117



Hex keys with handle Klucze imbusowe z rękojeścią.....	113
Hex keys & sets Klucze imbusowe i zestawy.....	114
Torx Tamperproof keys Klucze imbusowe „Torx Tamperproof”.....	117
Plastic covered Hex keys Klucze imbusowe powlekane.....	117

GB Screwdriver RO Șurubelniță  
 D Schraubendreher F Tournevis  
 PL Wkrętarz I Cacciavite  
 RUS Отвёртка E Destornillador  
 CZ Šroubovák CN 螺丝刀  
 H Csavarhúzó

PLASTIC HANGER



COLOR BOX



PCS packing:



S2

HRC 58



YATO	⊖	L (mm)	PCS packing:	
YT-2675	2	75	12	96/384
YT-2760	3	75	12	96/384
YT-2761	3	100	12	96/384
YT-2715	3	150	12	60/240
YT-2716	3	200	12	60/240
YT-2676	4	100	12	96/384
YT-2677	4	150	12	96/384
YT-2678	4	200	12	96/384

YATO	⊖	L (mm)	PCS packing:	
YT-2679	5	38	12	60/240
YT-2762	5	75	12	60/240
YT-2763	5	100	12	60/240
YT-2764	5	150	12	60/240
YT-2717	5	200	12	36/144
YT-2718	5	250	6	36/144
YT-2719	5	300	6	24/96
YT-2765	6	38	12	60/240

YATO	⊖	L (mm)	PCS packing:	
YT-2766	6	100	12	36/144
YT-2767	6	150	12	36/144
YT-2768	6	200	12	36/144
YT-2721	6	300	6	24/96
YT-2769	8	150	6	24/96
YT-2722	8	200	6	24/96
YT-2723	8	250	6	24/96



YATO	⊕	L (mm)	PCS packing:	
YT-2682	PH00	65	12	96/384
YT-2770	PH0	75	12	96/384
YT-2771	PH0	100	12	96/384
YT-2725	PH0	150	12	60/240
YT-2683	PH1	38	12	60/240
YT-2772	PH1	75	12	60/240
YT-2773	PH1	100	12	60/240

YATO	⊕	L (mm)	PCS packing:	
YT-2774	PH1	150	12	60/240
YT-2727	PH1	200	12	36/144
YT-2728	PH1	250	6	36/144
YT-2729	PH1	300	6	24/96
YT-2775	PH2	38	12	60/240
YT-2776	PH2	100	12	36/144
YT-2777	PH2	150	12	36/144

YATO	⊕	L (mm)	PCS packing:	
YT-2778	PH2	200	12	36/144
YT-2730	PH2	250	6	36/144
YT-2731	PH2	300	6	24/96
YT-2779	PH3	150	6	24/96
YT-2732	PH3	200	6	24/96
YT-2733	PH3	250	6	24/96



YATO	⊕	L (mm)	PCS packing:	
YT-2686	PZ0	75	12	96/384
YT-2687	PZ0	100	12	96/384
YT-2688	PZ1	75	12	60/240

YATO	⊕	L (mm)	PCS packing:	
YT-2689	PZ1	100	12	60/240
YT-2690	PZ1	200	12	36/144
YT-2691	PZ2	100	12	36/144

YATO	⊕	L (mm)	PCS packing:	
YT-2692	PZ2	150	12	36/144
YT-2693	PZ2	200	12	36/144
YT-2694	PZ3	150	6	24/96



YATO	☆	L (mm)	PCS packing:	
YT-2620	T5	75	12	96/384

YATO	☆	L (mm)	PCS packing:	
YT-2621	T6	75	12	96/384



YATO	☆	L (mm)	PCS packing:	
YT-2622	T7	75	12	96/384
YT-2623	T8	75	12	96/384
YT-2624	T9	75	12	96/384
YT-2625	T10	100	12	60/240

YATO	☆	L (mm)	PCS packing:	
YT-2626	T15	100	12	60/240
YT-2627	T20	100	12	60/240
YT-2628	T25	100	12	36/144
YT-2629	T27	100	12	36/144

YATO	☆	L (mm)	PCS packing:	
YT-2630	T30	100	12	36/144
YT-2631	T40	100	6	24/96

GB Screwdriver  
D Schraubendreher  
PL Wkrętak  
RUS Отвёртка  
CZ Šroubovák  
H Csavarhúzó

RO Şurubelniţă  
F Tournevis  
I Cacciavite  
E Destornillador  
CN 螺丝刀

PLASTIC  
HANGER



COLOR BOX

PCS  
packing



S2

HRC  
58



- application: for deep seated screws, e. g. in power tool casings
- przeznaczenie: do wkrętów głęboko osadzonych, np. w obudowach elektronarzędzi
- cut tip, constant diameter of shaft and tip
- grot frezowany, stała średnica grotu i końcówki

YATO	⊖	L (mm)	PCS packing	Box
YT-2840	5	150	12	60/240
YT-2842	5	250	6	36/144
YT-2843	5	300	6	24/96
YT-2844	6	150	12	36/144

YATO	⊖	L (mm)	PCS packing	Box
YT-2845	6	200	12	36/144
YT-2846	6	250	6	36/144
YT-2847	6	300	6	24/96

GB Go-through screwdriver  
D Schlagschrauber  
PL Wkrętak do pobijania  
RUS Отвёртка-било  
CZ Šroubovák s úderným koncem  
H Beütő csavarhúzó

RO Şurubelniţă pt. fixare  
F Tournevis à frapper  
I Cacciavite  
E Destornillador para dar golpes  
CN 敲击螺丝批

PLASTIC  
HANGER



COLOR BOX

6 PCS



CrV  
6150

HRC  
52



YATO	⊖	L (mm)	PCS packing	Box
YT-2699	6	100	6	24/96
YT-2700	6	150	6	24/96
YT-2701	6	200	6	24/96
YT-2702	6	250	6	24/96

YATO	⊖	L (mm)	PCS packing	Box
YT-2703	8	150	6	24/72
YT-2704	8	200	6	24/72
YT-2705	8	250	6	24/72
YT-2706	8	300	6	24/72



YATO	⊕	L (mm)	PCS packing	Box
YT-2708	PH2	100	6	24/96
YT-2709	PH2	150	6	24/96
YT-2710	PH3	150	6	24/72

YATO	⊕	L (mm)	PCS packing	Box
YT-2711	PH3	200	6	24/72
YT-2712	PH3	250	6	24/72

GB Screwdriver set  
D Schraubendrehersatz  
PL Komplet wkrętaków  
RUS Набор отвёрток

CZ Zámečnické šroubováky  
H Lakatos csavarhözó  
RO Şurubelniţe de lăcătuşerie  
F Set de clés à frapper

I Set cacciaviti  
E Juego de destornilladores  
CN 螺丝批组套

2  
PCS



CrV  
6150

HRC  
52



DOUBLE  
BLISTER



YATO	⊖	⊕	L (mm)	Box
YT-1600	6	PH2	150 150	6/36

GB Screwdriver set  
 D Schraubendrehersatz  
 PL Komplet wkrećtaków  
 RUS Набор отвёрток  
 CZ Zámečnické šroubováky  
 H Lakatos csavarhózó

RO Şurubelnițe de lăcătușerie  
 F Set de tournevis  
 I Set cacciaviti  
 E Juego de destornilladores  
 CN 螺丝批组套

DOUBLE BLISTER



S2

HRC 58

5

6  
PCS

⊖

⊕



YATO	⊖	⊕	L (mm)	
YT-2783	3		75	6/24
	5		100	
	6		100	
		PH0	75	
		PH1	100	
		PH2	100	

8  
PCS

⊖

⊕



YATO	⊖	⊕	L (mm)	
YT-2782	2.0		50	6/24
	2.4		50	
	6.0		38	
	6.0		100	
		PH0	50	
		PH1	50	
		PH2	38	
		PH2	100	

8  
PCS

⊖

⊕



YATO	⊖	⊕	L (mm)	
YT-2784	5		100	6/12
	6		100	
	8		150	
		PH0	75	
		PH1	100	
		PH2	38	
		PH2	100	
	PH3	150		

12  
PCS

⊖

⊕

⊗



YATO	⊖	⊕	⊗	L (mm)	
YT-2787	3			75	6/12
	5			75	
	6			38	
	6			150	
	8			150	
		PH0		75	
		PH1		75	
		PH2		38	
		PH2		100	
		PH3		150	
			SQ1	100	
			SQ2	100	

15  
PCS

⊖

⊕

⊗



YATO	⊖	⊕	⊗	L (mm)	
YT-2788	1.5			50	6/24
	2.0			50	
	5.0			75	
	6.0			38	
	6.0			100	
	6.0			125	
		PH00		50	
		PH0		50	
		PH1		75	
		PH2		38	
		PH2		100	
			T5	50	
			T6	50	
			T7	50	
			T8	50	

GB 6 in 1 interchangeable screwdriver set  
D Umsteckschraubendreher  
PL Wkrętak z końcówkami dwustronnymi  
RUS Отвёртка с двухсторонними насадками  
CZ Šroubovák lancet  
z dvoustrannou koncovkou  
H Csavarhúzó kétvégű szárral  
RO Şurubelniţă cu dublu capăt  
F Tournevis embouts réversibles  
I Cacciavite reversibile  
E Destornillador con punta de dos caras  
CN 6合1螺丝批组套



5.0 mm PH1  
6.0 mm PH2  
6 8 mm  
MAGNETIC TIP  
S2

DOUBLE BLISTER

**YATO**  
YT-2781 12/96

GB Screwdriver set  
D Schraubendrehersatz  
PL Komplet wkrętaków  
RUS Набор отвёрток  
CZ Zámečnické šroubováky  
H Lakatos csavarhózá  
RO Şurubelniţe de lăcătuşerie  
F Set de tournevis  
I Set cacciaviti  
E Juego de destornilladores  
CN 螺丝批组套

HRC 58  
S2



PLASTIC HANGER & DOUBLE BLISTER

DOUBLE BLISTER

1/4" (6.3 mm): 5, 8 mm (L=25 mm);  
1/4" (6.3 mm): PH1, PH2, PH3 (L=25 mm);  
1/4" (6.3 mm): T10, T15 (L=25 mm);  
1/4" (6.3 mm): 4, 5, 6 mm (L=25 mm)

9 PCS

PLASTIC HANGER

18 PCS

27 PCS

YATO	⊖	⊕	L (mm)	
YT-2785	3		75	6/12
	5		75	
	6		100	
	6		150	
	8		150	
		PH0	75	
		PH1	75	
		PH2	100	
		PH2	150	

YATO	⊖	⊕	⊗	L (mm)	
YT-2786	2.4			50	6/12
	3.0			50	
	5.0			75	
	6.0			38	
	6.0			100	
	6.0			150	
	8.0			150	
		PH00		50	
		PH0		50	
		PH1		75	
		PH2		38	
		PH2		100	
		PH3		150	
			T5	50	
			T6	50	
			T7	50	
		T8	50		
		T9	50		
		T10	50		

YATO	⊖	⊕	L (mm)		
YT-2789	2.0		50	2/10	
	2.4		50		
	3.0		75		
	5.0		75		
	6.0		38		
	6.0		100		
	8.0		150		
		PH00			50
		PH0			50
		PH0			75
		PH1			75
		PH2			38
		PH2			100
		PH3			150

GB Mini pick & hook set  
D Mini hacken set  
PL Zestaw haczyków z rękojmią  
RUS Набор ключков с рукоятками  
CZ Sada háčkových mini páčidel  
H Mini ár és kampó készlet  
RO Mini-set pt. extras garnituri  
F Set de crochets  
I Set ganci con maniglia  
E Juego de palancas de hierro  
CN 迷你拉拔器组套

HRC 40  
4 PCS



SLIDING CARD

**YATO**  
YT-0843 12/72

- GB Precision screwdriver set
- D Präzisions-Feinmechanikersatz
- PL Zestaw wkrętek precyzyjnych
- RUS Набор прецизионных отвёрток
- CZ Šroubováky sada pro jemnou mechaniku
- H Órás csavarhúzó készlet
- RO Set surubelnite
- F Set de tournevis de précision
- I Set cacciavite di precisione
- E Destornilladores precisos
- CN 螺丝批组套



PLASTIC BOX & DOUBLE BLISTER

5

6 PCS



HRC 58



6 PCS



HRC 58



S2

YATO	⊖	⊕	L (mm)	
YT-2790	1.4		50	15/60
	2.0		50	
	2.4		50	
		PH00	50	
		PH0	50	
		PH1	50	

YATO	⊕	L (mm)	
YT-2791	T5	50	15/60
	T6	50	
	T7	50	
	T8	50	
	T9	50	
	T10	50	



6 PCS



7 PCS



HRC 58



7 PCS



YATO	⊕	L (mm)	
YT-2576	T5	40	6/36
	T6	40	
	T7	40	
	T8	40	
	T9	40	
	T10	40	

YATO	⊖	⊕	⊕	L (mm)	
YT-2795	2.4			40	6/36
	3.0			40	
		PH00		40	
		PH0		40	
			T6	40	
			T7	40	
			T8	40	

YATO	⊖	⊕	⊕	L (mm)	
YT-2577	2.4			40	6/36
	3.0			40	
		PH00		40	
		PH0		40	
			T8	40	
			T9	40	
			T10	40	

- GB Long precision screwdriver set
- D Präzisions-Feinmechanikersatz
- PL Zestaw wkrętek precyzyjnych długich
- RUS Набор прецизионных отвёрток
- CZ Šroubováky sada pro jemnou mechaniku
- H Órás csavarhúzó készlet
- RO Set surubelnite
- F Set de tournevis
- I Set cacciavite di precisione
- E Destornilladores precisos
- CN 长钟表螺丝批组套



6 PCS



S2



SLIDING CARD



YATO	⊖	⊕	L (mm)	
YT-2575	2.5		150	12/120
	3.0		150	
	3.5		150	
		PH00	150	
		PH0	150	
		PH1	150	



GB Screwdriver  
D Schraubendreher  
PL Wkrętak  
RUS Отвёртка  
CZ Šroubovák  
H Csavarhúzó

RO Şurubelniţă  
F Tournevis  
I Cacciavite  
E Destornillador  
CN 螺丝刀

PLASTIC  
HANGER



COLOR BOX





PCS  
packing:





S2



HRC  
58





YATO 	⊖	L (mm)	PCS packing:	
YT-25900	2	75	12	96/384
YT-25901	3	75	12	96/384
YT-25902	3	100	12	96/384
YT-25903	3	150	12	60/240
YT-25904	4	100	12	96/384
YT-25905	4	150	12	96/384
YT-25906	4	200	12	96/384
YT-25907	5	75	12	60/240



YATO 	⊖	L (mm)	PCS packing:	
YT-25908	5	100	12	60/240
YT-25909	5	150	12	60/240
YT-25910	6	38	12	60/240
YT-25911	6	100	12	36/144
YT-25912	6	150	12	36/144
YT-25913	6	200	12	36/144
YT-25914	8	150	6	24/96





YATO 	⊕	L (mm)	PCS packing:	
YT-25920	PH0	75	12	96/384
YT-25921	PH0	100	12	96/384
YT-25922	PH1	38	12	60/240
YT-25923	PH1	75	12	60/240
YT-25924	PH1	100	12	60/240
YT-25925	PH1	150	12	60/240
YT-25926	PH1	200	12	36/144
YT-25927	PH1	300	6	24/96

YATO 	⊕	L (mm)	PCS packing:	
YT-25928	PH2	38	12	60/240
YT-25929	PH2	100	12	36/144
YT-25930	PH2	150	12	36/144
YT-25931	PH2	200	12	36/144
YT-25932	PH2	300	6	24/96
YT-25933	PH3	150	6	24/96
YT-25934	PH3	200	6	24/96



YATO 	⊕	L (mm)	PCS packing:	
YT-25940	PZ1	75	12	60/240
YT-25941	PZ1	100	12	60/240



YATO 	⊕	L (mm)	PCS packing:	
YT-25942	PZ2	100	12	36/144
YT-25943	PZ2	150	12	36/144





YATO 	⊛	L (mm)	PCS packing:	
YT-25950	T5	75	12	96/384

YATO 	⊛	L (mm)	PCS packing:	
YT-25951	T6	75	12	96/384



YATO 	⊛	L (mm)	PCS packing:	
YT-25952	T7	75	12	96/384
YT-25953	T8	75	12	96/384
YT-25954	T9	75	12	96/384
YT-25955	T10	100	12	60/240
YT-25956	T15	100	12	60/240

YATO 	⊛	L (mm)	PCS packing:	
YT-25957	T20	100	12	60/240
YT-25958	T25	100	12	36/144
YT-25959	T27	100	12	36/144
YT-25960	T30	100	12	36/144
YT-25961	T40	100	6	24/96

GB Go-through screwdriver  
D Schlagschrauber  
PL Wkrętek do robienia  
RUS Отвёртка-било  
CZ Šroubovák  
s úderným koncem  
H Beütő csavarhúzó

RO Şurubelniţă pt. fixare  
F Tournevis à frapper  
I Cacciaviti per viti  
con intaglio  
E Destornillador  
para dar golpes  
CN 敲击螺丝批

PLASTIC  
HANGER



6 PCS

COLOR BOX



CrV  
6150

HRC  
52



YATO	⊖	L (mm)	PCS packing	
YT-25985	6	100	6	24/96
YT-25986	6	150	6	24/96
YT-25987	6	200	6	24/96
YT-25988	6	250	6	24/96
YT-25989	8	150	6	24/72
YT-25990	8	200	6	24/72
YT-25991	8	250	6	24/72
YT-25992	8	300	6	24/72

YATO	⊕	L (mm)	PCS packing	
YT-25993	PH2	100	6	24/96
YT-25994	PH2	150	6	24/96
YT-25995	PH3	150	6	24/72
YT-25996	PH3	200	6	24/72
YT-25997	PH3	250	6	24/72

GB Screwdriver set  
D Schraubendrehersatz  
PL Komplet wkręteków  
RUS Набор отвёрток  
CZ Zámečnické šroubováky  
H Lakatos csavarhúzó  
RO Şurubelniţe de lăcătuşerie  
F Set de tournevis  
I Set cacciaviti  
E Juego de destornilladores  
CN 螺丝批组套

2  
PCS



CrV  
6150

HRC  
52



DOUBLE  
BLISTER



YATO	⊖	⊕	L (mm)	
YT-25998	6		150	6/36
		PH2	150	

GB Screwdriver set  
D Schraubendrehersatz  
PL Komplet wkręteków  
RUS Набор отвёрток  
CZ Zámečnické šroubováky  
H Lakatos csavarhúzó

RO Şurubelniţe de lăcătuşerie  
F Set de tournevis  
I Set cacciaviti  
E Juego de destornilladores  
CN 螺丝批组套

DOUBLE  
BLISTER



S2

HRC  
58



6  
PCS



YATO	⊖	⊕	L (mm)	
YT-25965	3.0		75	6/24
	5.0		100	
	6.0		100	
		PH0	75	
		PH1	100	
		PH2	100	



8  
PCS



YATO	⊖	⊕	L (mm)	
YT-25980	2.0		50	6/24
	2.4		50	
	6.0		38	
	6.0		100	
		PH0	50	
		PH1	50	
		PH2	38	
		PH2	100	

GB Screwdriver set  
D Schraubendrehersatz  
PL Komplet wkrętaków  
RUS Набор отвёрток  
CZ Zámečnické šroubováky  
H Lakatos csavarhózó

RO Şurubelnițe de lăcătușerie  
F Set de tournevis  
I Set cacciaviti  
E Juego de destornilladores  
CN 螺丝批组套

DOUBLE  
BLISTER



S2

HRC  
58



8  
PCS



12  
PCS



YATO	⊖	⊕	L (mm)	
YT-25966	5.0		100	6/12
	6.0		100	
	8.0		150	
		PH0	75	
		PH1	100	
		PH2	38	
		PH2	100	
		PH3	150	

YATO	⊖	⊕	⊗	L (mm)	
YT-25967	3.0			75	6/12
	5.0			75	
	6.0			38	
	6.0			150	
	8.0			150	
		PH0		75	
		PH1		75	
		PH2		38	
		PH2		100	
		PH3		150	
			SQ1	100	
		SQ2	100		



15  
PCS



YATO	⊖	⊕	⊗	L (mm)	
YT-25981	1.5			50	6/24
	2.0			50	
	5.0			75	
	6.0			38	
	6.0			100	
	6.0			125	
		PH00		50	
		PH0		50	
		PH1		75	
		PH2		38	
		PH2		100	
			T5	50	
			T6	50	
			T7	50	
			T8	50	

GB 6 in 1 interchangeable screwdriver set  
D Umsteckschraubendreher  
PL Wkrętak z końcówkami dwustronnymi  
RUS Отвёртка с двухсторонними насадками  
CZ Šroubovák lancer  
z dvoustrannou koncovkou  
H Csavarhúzó kétfélgű szárral  
RO Şurubelniță cu dublu capăt  
F Tournevis embouts réversibles  
I Cacciavite reversibile  
E Destornillador con punta de dos caras  
CN 6合1螺丝批组套



⊖ 5.0  
mm  
⊕ PH1

⊖ 6.0  
mm  
⊕ PH2

1/4"  
(6.3 mm)

MAGNETIC  
TIP

S2

5/16"  
(8 mm)

DOUBLE  
BLISTER



YATO

YT-25971

12/96

GB Screwdriver set      CZ Zámečnické šroubováky      I Set cacciaviti  
 D Schraubendrehersatz      H Lakatos csavarhózó      E Juego de destornilladores  
 PL Komplet wkręteków      RO Șurubelnițe de lăcătușerie      CN 螺丝批组套  
 RUS Набор отвёрток      F Set de tournevis



S2

HRC 58

5



9  
PCS



PLASTIC HANGER



YATO	⊖	⊕	L (mm)	
YT-25968	3.0		75	6/12
	5.0		75	
	6.0		100	
	6.0		150	
	8.0		150	
		PH0	75	
		PH1	75	
		PH2	100	
		PH2	150	



18  
PCS



PLASTIC HANGER & DOUBLE BLISTER



YATO	⊖	⊕	★	L (mm)	
YT-25982	2.4			50	6/12
	3.0			50	
	5.0			75	
	6.0			38	
	6.0			100	
	8.0			150	
		PH00		50	
		PH0		50	
		PH1		75	
		PH2		38	
		PH2		100	
		PH3		150	
		T5		50	
		T6		50	
		T7		50	
		T8		50	
	T9		50		
	T10		50		

GB Screwdriver CZ Šroubovák I Cacciavite  
D Schraubendreher H Csavarhúzó E Destornillador  
PL Wkrętak RO Șurubelniță CN 螺丝刀  
RUS Отвёртка F Tournevis

COLOR BOX

SVC55



- application: industry
- can be used as go-through
- special highest quality alloy steel
- przeznaczenie: przemysł
- możliwość pobijania
- stal wysokostopowa



YATO	⊖	L (mm)	PCS packing	☐
YT-2601	3.0	75	12	240
YT-2606	4.0	100	12	240
YT-2608	5.5	100	12	240
YT-2609	5.5	150	12	240
YT-2610	5.5	200	12	240
YT-2612	6.5	38	12	240
YT-2613	6.5	100	12	240
YT-2614	6.5	150	12	240
YT-2615	6.5	200	12	240
YT-2618	8.0	150	6	120

YATO	⊖	L (mm)	PCS packing	☐
YT-2602	3.0	100	12	240
YT-2633	3.0	300	12	240
YT-2603	4.0	38	12	240
YT-2604	4.0	75	12	240
YT-2607	4.0	150	12	240
YT-2634	4.0	400	12	240
YT-2635	5.0	300	12	120
YT-2636	5.0	400	12	120
YT-2619	8.0	200	6	120

- application: industry
- can be used as go-through
- special highest quality alloy steel
- przeznaczenie: przemysł
- możliwość pobijania
- stal wysokostopowa



YATO	⊕	L (mm)	PCS packing	☐
YT-2640	PH0	75	12	240
YT-2642	PH1	75	12	240
YT-2643	PH1	100	12	240
YT-2644	PH1	150	12	240
YT-2645	PH1	200	12	240
YT-2647	PH2	38	12	240
YT-2648	PH2	100	12	240
YT-2649	PH2	150	12	240
YT-2650	PH2	200	12	240
YT-2653	PH3	150	6	120

YATO	⊕	L (mm)	PCS packing	☐
YT-2637	PH0	300	12	240
YT-2641	PH1	38	12	240
YT-2638	PH1	400	12	120
YT-2639	PH2	400	12	120

- application: industry
- can be used as go-through
- special highest quality alloy steel
- przeznaczenie: przemysł
- możliwość pobijania
- stal wysokostopowa



YATO	⊕	L (mm)	PCS packing	☐
YT-2661	PZ0	75	12	240
YT-2663	PZ1	100	12	240
YT-2665	PZ2	150	12	240
YT-2667	PZ3	150	6	240

YATO	⊕	L (mm)	PCS packing	☐
YT-2656	PZ0	300	12	240
YT-2654	PZ1	38	12	240
YT-2657	PZ1	400	12	120
YT-2655	PZ2	38	12	240
YT-2658	PZ2	400	12	120

- application: industry
- can be used as go-through
- special highest quality alloy steel
- przeznaczenie: przemysł
- możliwość pobijania
- stal wysokostopowa



YATO	⊗	L (mm)	PCS packing	☐
YT-2741	T5	75	12	240
YT-2742	T6	75	12	240

YATO	⊗	L (mm)	PCS packing	☐
YT-2743	T7	75	12	240
YT-2744	T8	75	12	240
YT-2745	T9	75	12	240
YT-2746	T10	100	12	240
YT-2748	T15	100	12	240
YT-2750	T20	100	12	240
YT-2752	T25	100	12	240
YT-2753	T27	100	12	240
YT-2754	T30	100	12	240
YT-2756	T40	100	12	240

YATO	⊗	L (mm)	PCS packing	☐
YT-2757	T45	100	12	240

GB Screwdriver set  
 D Schraubendrehersatz  
 PL Komplet wkreteków  
 RUS Набор отвёрток  
 CZ Zámečnické šroubováky  
 H Lakatos csavarhózó

RO Şurubelnițe de lăcătușerie  
 F Set de tournevis  
 I Set cacciaviti  
 E Juego de destornilladores  
 CN 螺丝批组套

DOUBLE  
BLISTER



SVCM  
**55**



HRC  
58-62

5



**6**  
PCS



 

YATO 	⊖	⊕	L (mm)	
YT-2668	5.5		100	6/24
	6.5		100	
	8.0		150	
		PH1	100	
		PH2	100	
		PH3	150	



**7**  
PCS



  

YATO 	⊖	⊕	⊕	L (mm)	
YT-2669	5.5			100	4/16
	6.5			38	
	6.5			150	
		PH1		100	
		PH2		150	
			PZ1	100	
		PZ2	150		



**8**  
PCS

YATO 	⊖	⊕	L (mm)	
YT-2670	4.0		100	4/16
	5.5		100	
	6.5		38	
	6.5		100	
		PH0	75	
		PH1	100	
		PH2	38	
		PH2	100	

GB Precision screwdriver  
D Präzisions-Schraubendreher  
PL Wkrętak precyzyjny  
RUS Отвёртка для точных работ

CZ Šroubovák pro jemnou mechaniku  
H Műszerész csavarhúzó  
RO Șurubelniță mecanica fina  
F Tournevis de précision

I Cacciavite di precisione  
E Destornillador de precisión  
CN 螺丝批

S2

HRC  
57-61



YATO	⊖	L (mm)	
YT-25802	1.4	50	50/400
YT-25803	1.6	50	50/400
YT-25804	1.8	50	50/400
YT-25805	2.0	50	50/400
YT-25806	2.0	75	50/400
YT-25807	2.4	50	50/400
YT-25808	2.4	75	50/400
YT-25809	3.0	50	50/400
YT-25810	3.0	75	50/400
YT-25811	3.0	100	50/400

YATO	⊕	L (mm)	
YT-25831	PH000	50	50/400
YT-25832	PH000	75	50/400
YT-25833	PH00	50	50/400
YT-25834	PH00	75	50/400
YT-25835	PH0	50	50/400
YT-25836	PH0	75	50/400
YT-25837	PH0	100	50/400
YT-25838	PH1	50	50/400
YT-25839	PH1	100	50/400
YT-25840	PH1	150	50/400



YATO	⊕	L (mm)	
YT-25841	PZ0	50	50/400
YT-25842	PZ0	75	50/400
YT-25843	PZ0	100	50/400
YT-25844	PZ1	50	50/400
YT-25845	PZ1	100	50/400
YT-25846	PZ1	150	50/400

YATO	⊗	L (mm)	
YT-25852	T5	50	50/400
YT-25853	T6	50	50/400
YT-25854	T7	50	50/400
YT-25855	T8	50	50/400
YT-25856	T9	50	50/400
YT-25857	T10	50	50/400

GB Precision screwdriver set  
D Präzisions-Feinmechanikersatz  
PL Zestaw wkrętaków precyzyjnych  
RUS Набор прецизионных отвёрток  
CZ Šroubováky sada pro jemnou mechaniku

H Órás csavarhúzó készlet  
RO Set surubelnite  
F Set de tournevis de précision  
I Set cacciavite di precisione  
E Destornilladores precisos  
CN 螺丝批组套

PLASTIC BOX & DOUBLE BLISTER



S2

HRC  
57-61



6  
PCS





6  
PCS



7  
PCS



YATO	⊖	⊕	L (mm)	
YT-25861	1.4		50	6/36
	2.0		50	
	2.4		50	
		PH00	50	
		PH0	50	
		PH1	50	

YATO	⊗	L (mm)	
YT-25862	T5	50	6/36
	T6	50	
	T7	50	
	T8	50	
	T9	50	
	T10	50	

YATO	⊖	⊕	⊗	L (mm)	
YT-25863	2.0			50	6/36
	3.0			50	
		PH00		50	
		PH0		50	
			T5	50	
			T6	50	
			T7	50	

GB Insulated screwdriver  
 D Isolierte Schraubendreher  
 PL Wkrętek izolowany  
 RUS Изолированная отвёртка  
 CZ Izolovaný šroubovák  
 H Szigetelt csavarhúzó

RO Şurubelniţă izolată  
 F Tournevis isolé  
 I Cacciavite isolato  
 E Destornillador aislado  
 CN 绝缘螺丝批

PLASTIC HANGER



1000 V S2 HRC 56-60



• application: industry • przeznaczenie: przemysł  
 • VDE certificate • certyfikat VDE

YATO	⊖	L (mm)	☐
YT-2815	3.0	75	12/120
YT-2816	4.0	75	12/120
YT-2817	4.0	100	12/120

YATO	⊖	L (mm)	☐
YT-2818	5.5	125	12/120
YT-2819	6.5	150	12/120
YT-2820	8.0	175	12/120



• application: industry • przeznaczenie: przemysł  
 • VDE certificate • certyfikat VDE

YATO	⊕	L (mm)	☐
YT-2821	PH0	60	12/120
YT-2822	PH1	80	12/120

YATO	⊕	L (mm)	☐
YT-2823	PH2	100	12/120
YT-2824	PH3	150	12/120



• application: industry • przeznaczenie: przemysł  
 • VDE certificate • certyfikat VDE

YATO	⊕	L (mm)	☐
YT-2825	PZ1	80	12/120

YATO	⊕	L (mm)	☐
YT-2826	PZ2	100	12/120

GB Insulated screwdriver set  
 D Isolierte Schraubendrehersatz  
 PL Komplet wkrętek izolowanych  
 RUS Изолированная отвёртка - набор  
 CZ Izolované šroubováky  
 H Szigetelt csavarhúzó

RO Şurubelniţă izolată  
 F Set de tournevis isolés  
 I Set di cacciavite isolato  
 E Juego de destornilladores aislado  
 CN 绝缘螺丝批组套

DOUBLE BLISTER



1000 V S2 HRC 56-60



5 PCS



• application: industry • przeznaczenie: przemysł  
 • VDE certificate • certyfikat VDE

YATO	⊖	⊕	L (mm)	☐
YT-2827	3.0		75	20/40
	4.0		100	
	5.5		125	
		PH1	80	
		PH2	100	



7 PCS



• application: industry • przeznaczenie: przemysł  
 • VDE certificate • certyfikat VDE

YATO	⊖	⊕	⊕	L (mm)	☐
YT-2828	3.0			75	20/40
	4.0			100	
	5.5			125	
		PH1		80	
		PH2		100	
			PZ1	80	
			PZ2	100	



- GB Ratchet screwdriver set  
D Ratschenschraubendreher-Satz mit einsetzen  
PL Zestaw wkrętask z grzechotką  
RUS Набор головок с трещоткой  
CZ Ráčnový kloubový šroubovák s příslušenstvím  
H Dugókulcs és bit készlet csuklós  
RO Set surubelnita  
F Clé mixte à cliquet tête articulée + embouts  
I Set cacciavite a cricchetto  
E Juego con destornillador y carraca  
CN 棘轮螺丝批组套

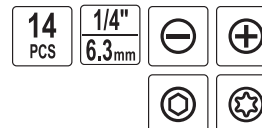

DOUBLE BLISTER

- 5, 6 mm;  
⊕ PH1, PH2;  
⊕ T15, T20;  
○ 5, 6, 7, 8, 10, 12, 13 mm



- GB 22 in 1 interchangeable screwdriver set  
D Umsteckschraubendreher  
PL Wkrętask z końcówkami dwustronnymi  
RUS Отвёртка - двухсторонние насадки  
CZ Šroubovák lancer z dvoustrannou koncovkou  
H Csavarhúzó kétvégű szárral

- RO Şurubelniţă cu dublu capăt  
F Tournevis + embouts 22 en 1  
I Set cacciavite con punte reversibile  
E Destornillador con punta dos caras  
CN 22合一螺丝批组套

DOUBLE BLISTER

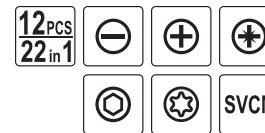

- 4 mm x 5.5 mm (L=175/115 mm);  
□ 6.5 mm x PH3 (L=175/115 mm);  
⊕ PH1 x PH2 (L=175/115 mm);  
⊕ PZ1 x PZ2 (L=175/115 mm);  
○ 3 mm x 3 mm (L=175/115 mm);  
○ 4 mm x 4 mm (L=175/115 mm);  
○ 5 mm x 5 mm (L=175/115 mm);  
○ 6 mm x 6 mm (L=175/115 mm);  
⊕ T10 x T15 (L=175/115 mm);  
⊕ T20 x T25 (L=175/115 mm);  
⊕ T30 x T40 (L=175/115 mm)



- GB Ratchet screwdriver set  
D Ratschenschraubendreher-set mit einsetzen  
PL Wkrętask z grzechotką, nasadkami i bitami  
RUS Набор головок с трещоткой  
CZ Ráčnový kloubový šroubovák s příslušenstvím  
H Dugókulcs és bit készlet csuklós

- RO Set surubelnita  
F Clé mixte à cliquet + embouts + douilles  
I Set cacciavite a cricchetto con prese punta  
E Juego con destornillador y carraca  
CN 棘轮螺丝批组套

DOUBLE BLISTER

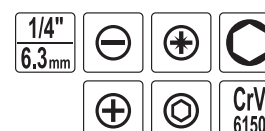

S2



- 1/4" (6.3 mm): 3.5, 4.0, 5.5, 6.5 mm (L=25 mm);  
⊕ 1/4" (6.3 mm): PH0, PH1, PH2, PH3 (L=25 mm);  
⊕ 1/4" (6.3 mm): PZ0, PZ1, PZ2, PZ3 (L=25 mm);  
○ 1/4" (6.3 mm): 4.0, 5.0, 6.0 mm (L=25 mm);  
□ 1/4" (6.3 mm): 5, 6(x2), 7(x2), 8, 9(x2), 10(x2), 11, 13 mm; CrV 6150;  
□ 1/4" (6.3 mm) x 1/4" (6.3 mm); (L=30 mm)

29 PCS



- 1/4" (6.3 mm): 3.5, 4.0, 5.5, 6.5 mm (L=25 mm);  
⊕ 1/4" (6.3 mm): PH0, PH1, PH2, PH3 (L=25 mm);  
⊕ 1/4" (6.3 mm): PZ0, PZ1, PZ2, PZ3 (L=25 mm);  
○ 1/4" (6.3 mm): 4.0, 5.0, 6.0 mm (L=25 mm);  
□ 1/4" (6.3 mm): 5, 6(x2), 7(x2), 8, 9(x2), 10(x2), 11, 13 mm; CrV 6150;  
□ 1/4" (6.3 mm) x 1/4" (6.3 mm); (L=30 mm); □ 1/4" (6.3 mm); (L=30 mm)

30 PCS



GB Ratchet screwdriver set  
 D Ratschenschraubendreher-Satz mit einsätzen  
 PL Wkrętak z grzechotką, przegubem i bitami  
 RUS Набор головок с трещеткой  
 CZ Ráčnový kloubový šroubovák s příslušenstvím

H Dugókulcs és bit készlet csukló  
 RO Set surubelnita  
 F Cliquet avec embouts  
 I Set di cacciavite a cricchetto e inserti  
 E Juego con destornillador y carraca  
 CN 棘轮螺丝批组套

BMC WITH WINDOW & COLOR BOX



1/4" 6.3mm

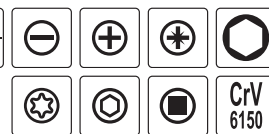

CrV 6150

50 PCS METRIC & S.A.E.



- ▮ 1/4" (6.3 mm): 2.0, 3.0, 3.5, 4.0, 4.5, 5.5, 6.5 mm (L=25 mm); S2;
- ✦ 1/4" (6.3 mm): PH0, PH1, PH2, PH3 (L=25 mm); S2;
- ✦ 1/4" (6.3 mm): PZ0, PZ1, PZ2, PZ3 (L=25 mm); S2;
- ⊛ 1/4" (6.3 mm): T10, T15, T20, T25, T27, T30 (L=25 mm); S2;
- ⊙ 1/4" (6.3 mm): 2.0, 3.0, 4.0, 5.0, 6.0 mm (L=25 mm); S2;
- 1/4" (6.3 mm): SQ0, SQ1, SQ2, SQ3 (L=25 mm); S2;
- ⊘ 1/4" (6.3 mm): 5, 6, 7, 8, 9, 10, 11, 12, 13 mm; CrV 6150;
- ⊘ 1/4" (6.3 mm): 1/4" (6.3 mm) x 3/16" (4.8 mm), 1/4" (6.3 mm) x 7/32" (5.6 mm), 1/4" (6.3 mm) x 1/4" (6.3 mm), 1/4" (6.3 mm) x 5/16" (7.9 mm), 1/4" (6.3 mm) x 11/32" (8.7 mm), 1/4" (6.3 mm) x 3/8" (9.5 mm), 1/4" (6.3 mm) x 7/16" (11.1 mm), 1/4" (6.3 mm) x 15/32" (11.9 mm), 1/4" (6.3 mm) x 1/2" (12.7 mm); CrV 6150;
- ⊘ 1/4" (6.3 mm); (L=150 mm)

**YATO** YT-2799 6/24

75 PCS



- ▮ 1/4" (6.3 mm): 2.0(x2), 3.0(x2), 3.5(x2), 4.0(x2), 4.5(x2), 5.0(x2), 5.5(x2), 6.5(x2) mm (L=25 mm); S2;
- ✦ 1/4" (6.3 mm): PH0(x2), PH1(x2), PH2(x2), PH3(x2) (L=25 mm); S2;
- ✦ 1/4" (6.3 mm): PZ0(x3), PZ1(x3), PZ2(x2), PZ3(x2) (L=25 mm); S2;
- ⊛ 1/4" (6.3 mm): T10(x3), T15(x3), T20(x3), T25(x3), T27(x2), T30(x2) (L=25 mm); S2;
- ⊙ 1/4" (6.3 mm): 2.0, 3.0, 4.0, 5.0, 6.0 mm (L=25 mm); S2;
- 1/4" (6.3 mm): SQ0(x2), SQ1(x2), SQ2(x2), SQ3(x2) (L=25 mm); S2;
- ⊘ 1/4" (6.3 mm): 5, 6, 7, 8, 9, 10, 11, 12, 13 mm; CrV 6150;
- ⊘ 1/4" (6.3 mm); (L=60 mm); CrV 6150/S2

**YATO** YT-2571 6/24

GB Precision screwdriver with bits  
 D Schraubendreher und bit-satz  
 PL Wkrętak elastyczny z wymiennymi bitami  
 RUS Отвёртка с прецизионными битами  
 CZ Šroubovák ráčnový se sadou bitů  
 H Órás csavarահúzó-bit készlet  
 RO Surubelnita + set biti  
 F Tourevis élastique  
 I Cacciavite flessibile con punte intercambiabili  
 E Juego de piezas terminales para destornillador + mango  
 CN 可弯曲批头组套

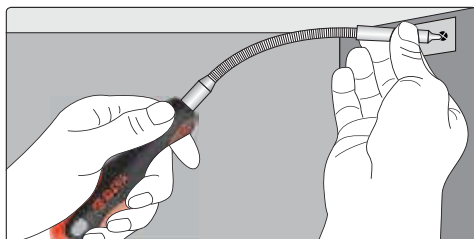

DOUBLE BLISTER

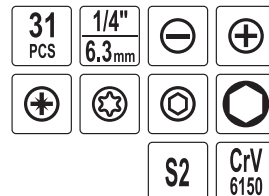

- ▮ 215 mm;
- ▮ 1/4" (6.3 mm): 3.0, 3.5, 4.0, 5.5, 6.5 mm (L=25 mm);
- ✦ 1/4" (6.3 mm): PH0, PH1, PH2, PH3 (L=25 mm);
- ✦ 1/4" (6.3 mm): PZ0, PZ1, PZ2, PZ3 (L=25 mm);
- ⊛ 1/4" (6.3 mm): T10, T15 (L=25 mm);
- ⊙ 1/4" (6.3 mm): 2.0, 3.0, 4.0, 5.0, 6.0 mm (L=25 mm);
- ⊘ 1/4" (6.3 mm): 5.0, 6.0, 7.0, 8.0(x2), 9.0, 10.0, 11.0, 12.0, 13.0 mm



**YATO** YT-2780 6/24

- ▮ 215 mm;
- ▮ 1/4" (6.3 mm): 3.0, 3.5, 4.0, 5.5, 6.5 mm (L=25 mm);
- ✦ 1/4" (6.3 mm): PH0, PH1, PH2, PH3 (L=25 mm);
- ✦ 1/4" (6.3 mm): PZ0, PZ1, PZ2, PZ3 (L=25 mm);
- ⊛ 1/4" (6.3 mm): T10, T15 (L=25 mm);
- ⊙ 1/4" (6.3 mm): 2.0, 3.0, 4.0, 5.0, 6.0 mm (L=25 mm);
- ⊘ 1/4" (6.3 mm): 5.0, 6.0, 7.0, 8.0(x2), 9.0, 10.0, 11.0, 12.0, 13.0 mm



**YATO** YT-25972 6/24

GB Ratchet screwdriver set  
D Ratschenschraubendreher-Satz mit einsätzen  
PL Wkrętak z grzechotką, przegubem i bitami  
RUS Набор головок с трещеткой  
CZ Rácnový kloubový šroubovák s příslušenstvím

H Dugókulcs és bit készlet csukló  
RO Set surubelnita  
F Clé mixte à cliquet + embouts  
I Set do chiavi a cricchetto e inserti  
E Juego con destornillador y carraca  
CN 棘轮螺丝批组套

PLASTIC BOX & COLOR BOX



42  
PCS

1/4"  
6.3mm



BITS x30  
AISI S2



CrV  
50BV30



1/4" (6.3 mm): 5, 6, 7, 8, 9, 10, 11, 12, 13 mm; 1/4" (6.3 mm) x 100 mm;

1/4" (6.3 mm); CrV 50BV30; H2, H2.5, H3, H4, H5, H6;

T10, T15, T20, T25, T27, T30, T40; PH1, PH1, PH2, PH2, PH3, PH3;

3, 4, 5, 6, 7 mm; PZ1, PZ1, PZ2, PZ2, PZ3, PZ3

<b>YATO</b>	
YT-2806	12

GB Impact screwdriver  
D Schlagschrauber  
PL Wkrętak udarowy  
RUS Отвёртка ударная

CZ Narazový šroubovák kovový  
H Csavarbehajtó, ütő üzemmóddal  
RO Șurubelniță metalică cu percutor  
F Tournevis à choc

I Cacciavite percussione  
E Destornillador de percusión  
CN 冲击螺丝批组套

BITS x6  
CrV 6150



1/2"  
12.5mm

5/16"  
8.0mm



8  
PCS

5/16" (7.9 mm) 1/2" (12.7 mm);  
PH2, PH3 (L=35 mm); PH2 (L=80 mm);  
8, 10 mm (L=35 mm); 8 mm (L=80 mm)



BMC & COLOR BOX

7  
PCS

5/16" (7.9 mm) 1/2" (12.7 mm);  
PH2, PH3 (L=35 mm); PH2 (L=80 mm);  
8, 10 mm (L=35 mm); 8 mm (L=80 mm)



METAL CASE & COLOR BOX

<b>YATO</b>	
YT-2800	20

<b>YATO</b>	
YT-2801	5/20



7  
PCS

5/16" (7.9 mm) 1/2" (12.7 mm);  
PH3 (L=35 mm); PH1, PH2, PH3 (L=75 mm);  
8 mm (L=35 mm); 8 mm (L=75 mm)



BMC & COLOR BOX

<b>YATO</b>	
YT-2802	20

GB Screwdriver bit set  
D Schraubendreherbitsatz  
PL Zestaw bitów do wkrętałów udarowych  
RUS Набор бит крестовых  
CZ Sada bitů

H Bitkészlet  
RO Truse bit  
F Embouts à choc  
I Set punte cacciavite  
E Puntas de destornilladora  
CN 冲击批头组套

CrV  
6150



SLIDING CARD

for / dla: YT-2800, YT-2801

YATO	+	-	L (mm)	⊕ (mm)	PCS packing	📦
YT-2810	PH2		36	5/16" (7.9 mm)	5	10/100
YT-2811	PH3		36	5/16" (7.9 mm)	5	10/100
YT-2812	PH2	8	36	5/16" (7.9 mm)	4	10/100
	PH3	10				

GB Screwdriver bit  
D Schraubendreherbit  
PL Końcówka śrubokrętowa  
RUS Бит крестовая  
CZ Šroubovaková koncovka  
H Csavarhúzóvég

RO Capăt pt. șurubelniță  
F Douille tournevis  
I Punta del cacciavite  
E Punta de destornilladora  
CN 旋具头

BLISTER CARD



TORX

AISI S2



YATO	⊕	L (mm)	⊕ (mm)	📦
YT-0404	T25	30	10	10/100
YT-0405	T25	75	10	10/100
YT-04051	T30	30	10	10/100
YT-04052	T30	75	10	10/100
YT-0406	T40	30	10	10/100
YT-0407	T40	75	10	10/100
YT-0408	T45	30	10	10/100
YT-0409	T45	75	10	10/100

GB Screwdriver bit  
D Schraubendreherbit  
PL Końcówka śrubokrętowa  
RUS Бит крестовая  
CZ Šroubovaková koncovka  
H Csavarhúzóvég

RO Capăt pt. șurubelniță  
F Douille tournevis  
I Punta del cacciavite  
E Punta de destornilladora  
CN 旋具头



+

COLD FORGED KUTE NA ZMNO

21.8Nm max.

AISI S2

HRC 58-62



SLIDING CARD



YATO	+	L (mm)	⊕ (mm)	📦
YT-0485	PH2	100	1/4" (6.3 mm)	25/100
YT-0486	PH2	150	1/4" (6.3 mm)	25/100
YT-0487	PH2	200	1/4" (6.3 mm)	25/100

GB Screwdriver bit  
D Schraubendreherbit  
PL Końcówka śrubokrętowa  
RUS Бит крестовая  
CZ Šroubovaková koncovka  
H Csavarhúzóvég

RO Capăt pt. șurubelniță  
F Douille tournevis  
I Punta del cacciavite  
E Punta de destornilladora  
CN 旋具头

PLASTIC BOX

AISI S2

HRC 58-61

COLD FORGED KUTE NA ZMNO



YATO	+	L (mm)	⊕ (mm)	torque / moment obrotowy max. (Nm)	PCS packing	📦
YT-04702	PZ1	25	1/4" (6.3 mm)	6.4	10	25/200
YT-04712	PZ2	25	1/4" (6.3 mm)	19.6	10	25/200
YT-04722	PZ3	25	1/4" (6.3 mm)	45.1	10	25/200

YATO	+	L (mm)	⊕ (mm)	torque / moment obrotowy max. (Nm)	PCS packing	📦
YT-04742	PH1	25	1/4" (6.3 mm)	6.4	10	25/200
YT-04752	PH2	25	1/4" (6.3 mm)	19.6	10	25/200
YT-04762	PH3	25	1/4" (6.3 mm)	45.1	10	25/200



YATO	+	L (mm)	⊕ (mm)	torque / moment obrotowy max. (Nm)	PCS packing	📦
YT-04772	PH1	50	1/4" (6.3 mm)	6.4	10	25/100
YT-04782	PH2	50	1/4" (6.3 mm)	19.6	10	25/100
YT-04792	PH3	50	1/4" (6.3 mm)	45.1	10	25/100

YATO	+	L (mm)	⊕ (mm)	torque / moment obrotowy max. (Nm)	PCS packing	📦
YT-04812	PH2	65	1/4" (6.3 mm)	19.6 / 19.6	10	25/100

GB Screwdriver bit set  
D Schraubendreherbitsatz  
PL Zestaw końcówek śrubokrętowych  
RUS Набор битов  
CZ Sada bitů  
H Bitkészlet

RO Truse bit  
F Embouts de vissage  
I Set punte cacciavite  
E Puntas de destornilladora  
CN 旋具头组套

PLASTIC BOX

10 PCS

AISI S2

HRC 58-61

COLD FORGED KUTE NA ZMNO



⊕ 5, 6 mm; ⊕ PH1, PH1, PH2, PH2;  
⊕ PZ1, PZ1, PZ2, PZ2

⊕ 5, 6 mm; ⊕ PH1, PH1, PH2, PH2;  
⊕ PZ1, PZ1, PZ2, PZ2

YATO	L (mm)	⊕ (mm)	📦
YT-04822	25	1/4" (6.3 mm)	25/200

YATO	L (mm)	⊕ (mm)	📦
YT-04832	50	1/4" (6.3 mm)	25/100

GB Screwdriver bit  
D Schraubendreherbit  
PL Końcówka śrubokrętowa  
RUS Бит крестовая

CZ Šroubovavá koncovka  
H Csavarhúzóvég  
RO Capăt pt. șurubelniță  
F Douille tournevis

I Punta del cacciavite  
E Punta de destornilladora  
CN 旋具头

PLASTIC BOX



AISI S2

HRC 58-61



YATO	+	L (mm)	Hex	torque / moment obrotowy max. (Nm)	PCS packing	Box
YT-78130	PH0	25	1/4" (6.3 mm)	2.1	10	20/100
YT-78131	PH1	25	1/4" (6.3 mm)	7.8	10	20/100
YT-78132	PH2	25	1/4" (6.3 mm)	19.6	10	20/100
YT-78133	PH3	25	1/4" (6.3 mm)	45.6	10	20/100

YATO	+	L (mm)	Hex	torque / moment obrotowy max. (Nm)	PCS packing	Box
YT-78134	PZ1	25	1/4" (6.3 mm)	6.4	10	20/100
YT-78135	PZ2	25	1/4" (6.3 mm)	19.6	10	20/100
YT-78136	PZ3	25	1/4" (6.3 mm)	45.1	10	20/100



YATO	+	L (mm)	Hex	torque / moment obrotowy max. (Nm)	PCS packing	Box
YT-78141	T10	25	1/4" (6.3 mm)	5.9	10	20/100
YT-78142	T15	25	1/4" (6.3 mm)	8.4	10	20/100
YT-78143	T20	25	1/4" (6.3 mm)	14.7	10	20/100
YT-78144	T25	25	1/4" (6.3 mm)	21.6	10	20/100
YT-78145	T27	25	1/4" (6.3 mm)	29.4	10	20/100
YT-78146	T30	25	1/4" (6.3 mm)	45.1	10	20/100
YT-78147	T40	25	1/4" (6.3 mm)	76.5	10	20/100

YATO	+	L (mm)	Hex	torque / moment obrotowy max. (Nm)	PCS packing	Box
YT-78150	PH0	50	1/4" (6.3 mm)	2.1	10	20/100
YT-78151	PH1	50	1/4" (6.3 mm)	6.4	10	20/100
YT-78152	PH2	50	1/4" (6.3 mm)	19.6	10	20/100
YT-78153	PH3	50	1/4" (6.3 mm)	45.1	10	20/100



YATO	+	L (mm)	Hex	torque / moment obrotowy max. (Nm)	PCS packing	Box
YT-78154	PZ1	50	1/4" (6.3 mm)	6.4	10	20/100
YT-78155	PZ2	50	1/4" (6.3 mm)	19.6	10	20/100
YT-78156	PZ3	50	1/4" (6.3 mm)	45.1	10	20/100

YATO	+	+	L (mm)	Hex	torque / moment obrotowy max. (Nm)	PCS packing	Box
YT-78160	PH1	PH1	65	1/4" (6.3 mm)	6.4 / 6.4	10	20/100
YT-78161	PH2	PH2	65	1/4" (6.3 mm)	19.6 / 19.6	10	20/100
YT-78162	PH3	PH3	65	1/4" (6.3 mm)	45.1 / 45.1	10	20/100
YT-78163	PH1	PH2	65	1/4" (6.3 mm)	6.4 / 19.6	10	20/100
YT-78164	PH2	PH3	65	1/4" (6.3 mm)	19.6 / 45.1	10	20/100



YATO	+	+	L (mm)	Hex	torque / moment obrotowy max. (Nm)	PCS packing	Box
YT-78165	PH1	4.5	65	1/4" (6.3 mm)	6.4 / 6.1	10	20/100
YT-78166	PH2	5.5	65	1/4" (6.3 mm)	19.6 / 8.8	10	20/100
YT-78167	PH3	6.5	65	1/4" (6.3 mm)	45.1 / 14.7	10	20/100

YATO	+	L (mm)	Hex (mm)	torque / moment obrotowy max. (Nm)	PCS packing	Box
YT-78190	M5	30	8	20.6	10	20/100
YT-78191	M6	30	8	40.2	10	20/100
YT-78192	M8	30	8	60.8	10	20/100
YT-78193	M10	30	8	156.9	8	10/50
YT-78194	M12	30	8	176.5	6	10/50

GB Screwdriver bit set  
D Schraubendreherbitsatz  
PL Zestaw końcówek śrubokrętowych  
RUS Набор битов  
CZ Sada bitů  
H Bitkészlet

RO Truse bit  
F Embouts de vissage  
I Set punte cacciavite  
E Puntas de destornilladora  
CN 旋具头组套



SLIDING CARD



COLD FORGED KUTE NA ZIMNO

218Nm max.

AISI S2

HRC 58-62



10 PCS



10 PCS



10 PCS



YATO	+	L (mm)	Hex	Box
YT-0470	PZ1	25	1/4" (6.3 mm)	25/200
YT-0471	PZ2	25	1/4" (6.3 mm)	25/200
YT-0472	PZ3	25	1/4" (6.3 mm)	25/200

YATO	+	L (mm)	Hex	Box
YT-0477	PH1	50	1/4" (6.3 mm)	25/100
YT-0478	PH2	50	1/4" (6.3 mm)	25/100
YT-0479	PH3	50	1/4" (6.3 mm)	25/100
YT-0480	PH2	75	1/4" (6.3 mm)	25/100

YATO	+	L (mm)	Hex	Box
YT-0473	PH0	25	1/4" (6.3 mm)	25/200
YT-0474	PH1	25	1/4" (6.3 mm)	25/200
YT-0475	PH2	25	1/4" (6.3 mm)	25/200
YT-0476	PH3	25	1/4" (6.3 mm)	25/200



10 PCS



10 PCS



10 PCS



⌀ 5,6 mm; ⚙ PH1, PH1, PH2, PH2;  
⚙ PZ1, PZ1, PZ2, PZ2

⌀ 5,6 mm; ⚙ PH1, PH1, PH2, PH2;  
⚙ PZ1, PZ1, PZ2, PZ2

YATO	+	L (mm)	Hex	Box
YT-0481	PH2	65	1/4" (6.3 mm)	25/100

YATO	+	L (mm)	Hex	Box
YT-0482		25	1/4" (6.3 mm)	25/200

YATO	+	L (mm)	Hex	Box
YT-0483		50	1/4" (6.3 mm)	25/100

GB Screwdriver bit  
D Schraubendreherbit  
PL Końcówka śrubokrętowa

RUS Бит крестовая  
CZ Šroubovaková koncovka  
H Csavarhúzóvég

RO Capăt pt. șurubelniță  
F Douille tournevis  
I Punta del cacciavite

E Punta de destornilladora  
CN 旋具头

COLOR BOX



AISI S2

HRC 58-62

GOLD FORGED KUTE NA ZMNO



YATO	⊖	L (mm)	⊕	PCS packing	📦
YT-7800	3.0	25	1/4" (6.3 mm)	50	20/40
YT-7801	4.0	25	1/4" (6.3 mm)	50	20/40
YT-7802	5.0	25	1/4" (6.3 mm)	50	20/40
YT-7803	5.5	25	1/4" (6.3 mm)	50	20/40
YT-7804	6.0	25	1/4" (6.3 mm)	50	20/40
YT-7805	6.5	25	1/4" (6.3 mm)	50	20/40



YATO	⊕	L (mm)	⊕	PCS packing	📦
YT-7806	PH0	25	1/4" (6.3 mm)	50	20/40
YT-7807	PH1	25	1/4" (6.3 mm)	50	20/40
YT-7808	PH2	25	1/4" (6.3 mm)	50	20/40
YT-7809	PH3	25	1/4" (6.3 mm)	50	20/40



YATO	⊕	L (mm)	⊕	PCS packing	📦
YT-7810	PZ1	25	1/4" (6.3 mm)	50	20/40
YT-7811	PZ2	25	1/4" (6.3 mm)	50	20/40
YT-7812	PZ3	25	1/4" (6.3 mm)	50	20/40



5



YATO	★	L (mm)	⊕	PCS packing	📦
YT-7813	T8	25	1/4" (6.3 mm)	50	20/40
YT-7814	T10	25	1/4" (6.3 mm)	50	20/40
YT-7815	T15	25	1/4" (6.3 mm)	50	20/40
YT-7816	T20	25	1/4" (6.3 mm)	50	20/40
YT-7817	T25	25	1/4" (6.3 mm)	50	20/40
YT-7818	T27	25	1/4" (6.3 mm)	50	20/40



YATO	★	L (mm)	⊕	PCS packing	📦
YT-7826	T27	25	1/4" (6.3 mm)	50	20/40



YATO	⊕	L (mm)	⊕	PCS packing	📦
YT-7829	2.0	25	1/4" (6.3 mm)	50	20/40
YT-7834	6.0	25	1/4" (6.3 mm)	50	20/40



YATO	⊖	L (mm)	⊕	PCS packing	📦
YT-7846	PH0	50	1/4" (6.3 mm)	50	10/20
YT-7847	PH1	50	1/4" (6.3 mm)	50	10/20
YT-7848	PH2	50	1/4" (6.3 mm)	50	10/20
YT-7849	PH3	50	1/4" (6.3 mm)	50	10/20



YATO	⊕	L (mm)	⊕	PCS packing	📦
YT-7851	PZ2	50	1/4" (6.3 mm)	50	10/20
YT-7852	PZ3	50	1/4" (6.3 mm)	50	10/20



YATO	⊕	L (mm)	⊕	PCS packing	📦
YT-7870	2.5	50	1/4" (6.3 mm)	50	10/20



YATO	⊕	⊕	L (mm)	⊕	PCS packing	📦
YT-7880	PH1	PH1	65	1/4" (6.3 mm)	50	10/20
YT-7881	PH2	PH2	65	1/4" (6.3 mm)	50	10/20
YT-7882	PH3	PH3	65	1/4" (6.3 mm)	50	10/20
YT-7883	PH1	PH2	65	1/4" (6.3 mm)	50	10/20
YT-7884	PH2	PH3	65	1/4" (6.3 mm)	50	10/20

YATO	⊕	⊖	L (mm)	⊕	PCS packing	📦
YT-7886	PH2	5.5	65	1/4" (6.3 mm)	50	10/20
YT-7887	PH3	6.5	65	1/4" (6.3 mm)	50	10/20

YATO	⊕	⊕	L (mm)	⊕	PCS packing	📦
YT-7890	PH3	PH3	110	1/4" (6.3 mm)	20	10/20

GB Screwdriver bit  
D Schraubendreherbit  
PL Końcówka śrubokrętowa

RUS Бит крестовая  
CZ Šroubovaková koncovka  
H Csavarhúzóvég

RO Capăt pt. șurubelniță  
F Douille tournevis  
I Punta del cacciavite

E Punta de destornilladora  
CN 旋具头

COLOR BOX



AISI S2

HRC 58-62



YATO	★	L (mm)	⊕	⊕	PCS packing	📦
YT-7897	T10	30	8	50	10/20	
YT-7898	T15	30	8	50	10/20	
YT-7899	T20	30	8	50	10/20	
YT-7901	T27	30	8	50	10/20	
YT-7906	T55	30	8	20	10/40	



YATO	★	L (mm)	⊕	⊕	PCS packing	📦
YT-7909	T15	30	8	50	10/20	
YT-7910	T20	30	8	50	10/20	
YT-7911	T25	30	8	50	10/20	
YT-7912	T27	30	8	50	10/20	
YT-7916	T50	30	8	50	10/20	



YATO	⊕	L (mm)	⊕	⊕	PCS packing	📦
YT-7929	M5	30	8	50	10/20	
YT-7930	M6	30	8	50	10/20	
YT-7931	M8	30	8	50	10/20	
YT-7932	M10	30	8	20	10/40	
YT-7933	M12	30	8	20	10/20	



YATO	⊖	L (mm)	⊕	⊕	PCS packing	📦
YT-7936	8.0	70	8	20	10/20	

YATO	★	L (mm)	⊕	⊕	PCS packing	📦
YT-7950	T60	70	8	20	5/10	

GB Screwdriver bit  
D Schraubendreherbit  
PL Końcówka śrubokrętowa  
RUS Бит крестовая  
CZ Šroubovaková koncovka  
H Csavarhúzóvég

RO Capăt pt. șurubelniță  
F Douille tournevis  
I Punta del cacciavite  
E Punta de destornilladora  
CN 旋具头



- with limiter
- z ogranicznikiem

COLOR BOX



YATO	L (mm)	⊕	⊕	PCS packing	📦
YT-7980	25	1/4" (6.3 mm)	20	20/40	

GB Screwdriver bit  
D Schraubendreherbit  
PL Końcówka śrubokrętowa  
RUS Бит крестовая

CZ Šroubovaková koncovka  
H Csavarhúzóvég  
RO Capăt pt. șurubelniță  
F Douille tournevis

I Punta del cacciavite  
E Punta de destornilladora  
CN 旋具头

SLIDING  
CARD



**2**  
PCS

**1/4"**  
(6.3mm)

**S2**

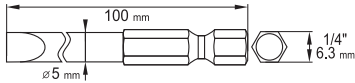

YATO	⊖	L (mm)	⊘	📦
YT-0484	4.0	100	1/4" (6.3 mm)	25/100
	5.0	100		

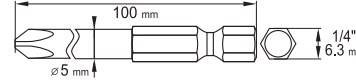

YATO	⊕	L (mm)	⊘	📦
YT-0459	PH00	100	1/4" (6.3 mm)	25/100
	PH0	100		

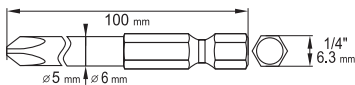

YATO	⊕	L (mm)	⊘	📦
YT-0488	PH1	100	1/4" (6.3 mm)	25/100
	PH2	100		

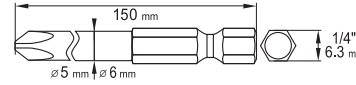

YATO	⊕	L (mm)	⊘	📦
YT-0489	PH1	150	1/4" (6.3 mm)	25/100
	PH2	150		

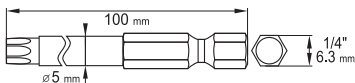

YATO	⊗	L (mm)	⊘	📦
YT-0490	T10	100	1/4" (6.3 mm)	25/100
	T25	100		

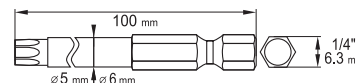

YATO	⊗	L (mm)	⊘	📦
YT-0491	T15	100	1/4" (6.3 mm)	25/100
	T27	100		
YT-0492	T20	100	1/4" (6.3 mm)	25/100
	T30	100		

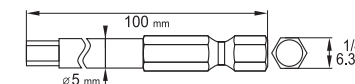

YATO	⊗	L (mm)	⊘	📦
YT-0494	3.0	100	1/4" (6.3 mm)	25/100
	5.0	100		

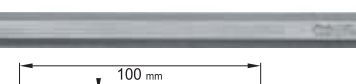
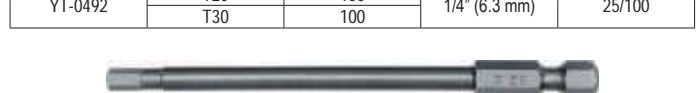

YATO	⊗	L (mm)	⊘	📦
YT-0495	4.0	100	1/4" (6.3 mm)	25/100
	6.0	100		

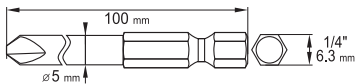
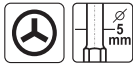

YATO	⊕	L (mm)	⊘	📦
YT-0493	#0	100	1/4" (6.3 mm)	25/100
	#1	100		
YT-0496	#1	100	1/4" (6.3 mm)	25/100
	#3	100		

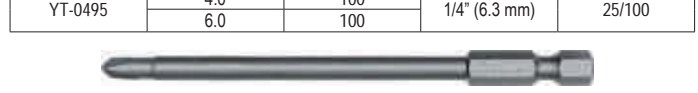

YATO	⊕	L (mm)	⊘	📦
YT-0497	#2	100	1/4" (6.3 mm)	25/100
	#4	100		

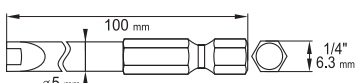

YATO	⊕	L (mm)	⊘	📦
YT-0498	#4	100	1/4" (6.3 mm)	25/100
	#8	100		

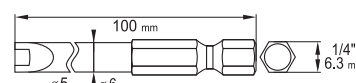

YATO	⊕	L (mm)	⊘	📦
YT-0499	#6	100	1/4" (6.3 mm)	25/100
	#10	100		

- GB Screwdriver bit set
- D Schraubendreherbitsatz
- PL Zestaw końcówek śrubokrętowych
- RUS Набор битов
- CZ Sada bitů
- H Bitkészlet
- RO Truse bit
- F Embouts de vissage
- I Set punte cacciavite
- E Puntas de destornilladora
- CN 旋具头组套

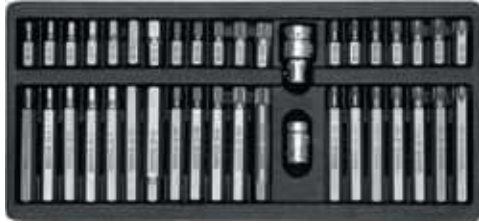

**218**<sub>max.</sub> **AISI S2** **HRC 58-62**

**40** **PCS** **HEX** **SPLINE** **TORX**

METAL CASE & COLOR BOX

○ x14: L=30 mm: H4, H5, H6, H7, H8, H10, H12; L=75 mm: H4, H5, H6, H7, H8, H10, H12; AISI S2;  
 ○ x10: L=30 mm: M5, M6, M8, M10, M12; L=75 mm: M5, M6, M8, M10, M12; AISI S2;  
 ⊕ x14: L=30 mm: T20, T25, T30, T40, T45, T50, T55; L=75 mm: T20, T25, T30, T40, T45, T50, T55; AISI S2;  
 ⊕ x2: 1/2" (12.7 mm): 10 mm, 3/8" (9.5 mm): 10 mm; CrV 6150

**YATO** **YT-0400** 10

**7** **PCS** **TORX**



⊕ x6: L=30 mm: T25, T30, T40, T45, T50, T55; AISI S2;  
 ⊕ 1/2" (12.7 mm): 10 mm; CrV 6150

HANGING COLOR BOX

**YATO** **YT-0410** 24/72

**7** **PCS** **HEX**



○ x6: L=30 mm: H4, H5, H6, H8, H10, H12 mm; AISI S2;  
 ○ 1/2" (12.7 mm): 10 mm; CrV 6150

HANGING COLOR BOX

**YATO** **YT-0412** 24/72

**6** **PCS** **SPLINE**



○ x5: L=30 mm: M5, M6, M8, M10, M12; AISI S2;  
 ○ 1/2" (12.7 mm): 10 mm; CrV 6150

HANGING COLOR BOX

**YATO** **YT-0414** 24/72

**7** **PCS** **TORX TAMPERPROOF**



⊕ x6: L=30 mm: T25, T30, T40, T45, T50, T55; AISI S2;  
 ⊕ 1/2" (12.7 mm): 10 mm; CrV 6150

HANGING COLOR BOX

**YATO** **YT-0416** 24/72

**8** **PCS** **RIBE**



⊕ x7: L=30 mm: M5, M6, M7, M8, M10, M12, M14; AISI S2;  
 ⊕ 1/2" (12.7 mm): 10 mm; CrV 6150

HANGING COLOR BOX

**YATO** **YT-0418** 24/72

**8** **PCS** **RIBE** **TORX TAMPERPROOF**



⊕ x18: L=30 mm: T20, T25, T30, T40, T45, T50, T55, T60, T70; AISI S2; L=75 mm: T20, T25, T30, T40, T45, T50, T55, T60, T70; AISI S2;  
 ⊕ x22: L=30 mm: M4, M5, M6, M7, M8, M9, M10, M11, M12, M13, M14; AISI S2; L=75 mm: M4, M5, M6, M7, M8, M9, M10, M11, M12, M13, M14; AISI S2;  
 ⊕ x2: 1/2" (12.7 mm): 10 mm, 3/8" (9.5 mm): 10 mm; CrV 6150

METAL CASE & COLOR BOX

**YATO** **YT-0420** 10



- GB Nut setter  
D Magnet-Steckschlüssel mit Adapter  
PL Nasadka magnetyczna do wkrętarki  
RUS Магнитная головка для винтовёрта  
CZ Nástrčný klíč magnetický do vrtačky  
H Csavarbehajtó  
RO Cheie tubulara cu prindere tip mandrina  
F Douille tournevis magnétique  
I Cappuccio magnetico la vite  
E Boquilla magnética de destornilladora  
CN 磁性套筒



YATO	Hex	PCS packing	Box
YT-1501	6	20	200/600
YT-1502	7	20	200/600
YT-1503	8	20	200/600
YT-1505	10	20	200/600
YT-1507	12	20	200/600
YT-1508	13	20	200/600

YATO	Hex	Box
YT-1511	6	100/200
YT-1512	7	100/200
YT-1513	8	100/200
YT-1515	10	100/200
YT-1517	12	100/200
YT-1518	13	100/200

- GB Screwdriver bit holder  
D Bithalter  
PL Uchwyt do końcówek śrubokrętowych  
RUS Магнитный держатель
- CZ Držák na šroubovavkovékoncovky  
H Szár a csavarhúzóvégekhez  
RO Capete șurubelniță  
F Mandrin magnétique
- I Mandrino portapunta  
E Mandril para puntas  
CN 旋具磁性接杆



YATO	Hex	L (mm)	Box
YT-0465	1/4" (6.3 mm)	60	20/200

YATO	Hex	L (mm)	Box
YT-0466	1/4" (6.3 mm)	60	20/200



YATO	Hex	L (mm)	Box
YT-0467	1/4" (6.3 mm)	80	20/200

YATO	Hex	L (mm)	Box
YT-0468	1/4" (6.3 mm)	60	20/200

- GB Hex with ball with handle  
D Aufsteckschlüssel  
PL Klucz trzpieniowy z rączką  
RUS Ключ торцевой  
CZ Čepový klíč  
H Csapkulcs  
RO Chei cu cozi  
F Tournevis 6 pans à boule  
I Cacciavite a brugola con testina a sfera  
E Llave de mandril  
CN 球头内六角螺丝批

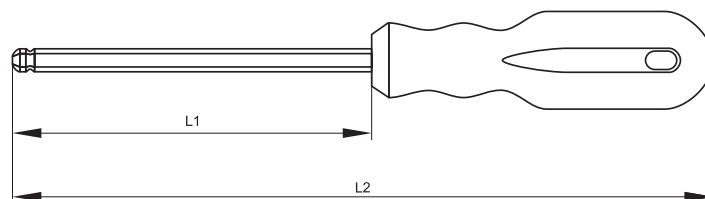

COLOR BOX



YATO	Hex (mm)	L1 (mm)	L2 (mm)	PCS packing	Box
YT-1530	2.0	75	175	12	240
YT-1531	2.5	75	175	12	240
YT-1532	3.0	100	200	12	240
YT-1533	4.0	100	205	12	240

YATO	Hex (mm)	L1 (mm)	L2 (mm)	PCS packing	Box
YT-1534	5.0	100	205	12	240
YT-1535	6.0	125	242	12	240
YT-1537	8.0	150	278	6	120
YT-1539	10.0	150	278	6	120

- GB Hex key
- D Sechskant-Stiftschlüssel
- PL Klucz sześciokątny
- RUS Шестигранный
- CZ Imbusový klíč
- H Imbisz kulcs
- RO Cheie imbus
- F Clé Allen
- I Chiave a brugola
- E Llave hexagonal
- CN 内六角扳手

HEX CrV 6150 HRC 52-55

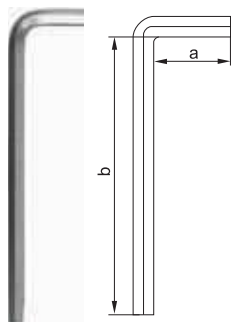

YATO	Ø (mm)	a (mm)	b (mm)	PCS
YT-0546	6	24	110	20/200

5

- GB Hex key
- RUS Шестигранный
- RO Cheie imbus
- E Llave hexagonal
- D Sechskant-Stiftschlüssel
- CZ Imbusový klíč
- F Clé Allen
- CN 内六角扳手
- PL Klucz sześciokątny
- H Imbisz kulcs
- I Chiave esagonale

POUCH



CrV 6150

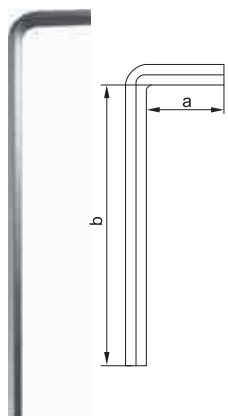

YATO	Ø (mm)	a (mm)	b (mm)	PCS packing:
YT-5761	2.0	16	99	12 20/80

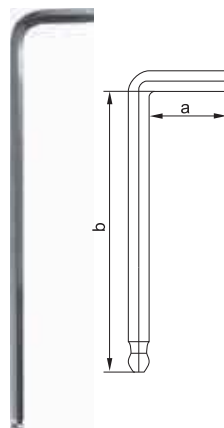

S.A.E.



YATO	Ø (mm)	a (mm)	b (mm)	PCS packing:
YT-5770	1/16" (1.6 mm)	14	90	12 20/80
YT-5771	5/64" (2.0 mm)	16	100	12 20/80
YT-5772	3/32" (2.4 mm)	17	111	12 20/80
YT-5773	7/64" (2.8 mm)	18	116	12 20/80
YT-5774	1/8" (3.2 mm)	19	123	12 20/80
YT-5775	9/64" (3.6 mm)	20	130	12 20/80
YT-5777	3/16" (4.8 mm)	24	151	6 10/20
YT-5778	7/32" (5.6 mm)	25	165	6 10/20
YT-5779	1/4" (6.3 mm)	28	183	6 10/20
YT-5780	5/16" (7.9 mm)	32	202	6 10/20
YT-5781	3/8" (9.5 mm)	35	233	6 10/20

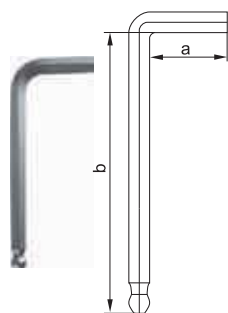

YATO	Ø (mm)	a (mm)	b (mm)	PCS packing:
YT-5785	1.5	13	45	12 20/80
YT-5786	2.0	15	49	12 20/80
YT-5791	6.0	30	91	6 20/40
YT-5792	7.0	32	95	6 20/40
YT-5793	8.0	34	98	6 20/40
YT-5794	10.0	37	111	6 20/40

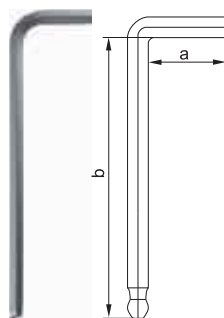

YATO	Ø (mm)	a (mm)	b (mm)	PCS packing:
YT-5795	1.5	13	62	12 20/80
YT-5796	2.0	15	75	12 20/80
YT-5797	2.5	17	85	12 20/80
YT-5798	3.0	19	89	12 20/80
YT-5802	7.0	33	140	6 20/40
YT-5803	8.0	34	150	6 20/40
YT-5804	10.0	36	172	6 20/40

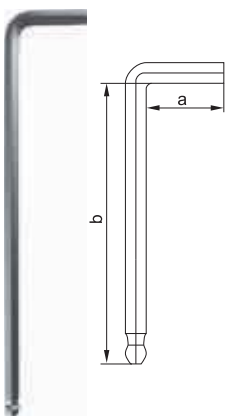

YATO	Ø (mm)	a (mm)	b (mm)	PCS packing:
YT-5805	1.5	14	89	12 20/80
YT-5806	2.0	15	99	12 20/80
YT-5807	2.5	18	110	12 20/80
YT-5808	3.0	20	124	12 20/80
YT-5812	7.0	31	187	6 10/20
YT-5813	8.0	34	198	6 10/20
YT-5814	10.0	38	220	6 10/20

- GB TORX key
- D TORX-Stiftschlüssel
- PL Klucz TORX
- RUS Ключ TORX
- CZ Klíč TORX
- H Kulcs TORX
- RO Cheie TORX
- F Clé TORX
- I Chiavi TORX
- E Llave TORX
- CN 内六角扳手

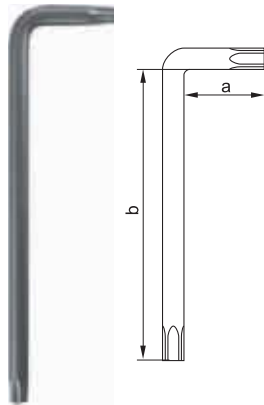

POUCH



CrV  
6150

YATO	Hex	a (mm)	b (mm)	PCS packing	
YT-5820	T6	16	69	12	20/80
YT-5821	T7	16	73	12	20/80
YT-5822	T8	16	77	12	20/80
YT-5823	T9	16	81	12	20/80
YT-5832	T50	32	155	6	20/40
YT-5833	T55	35	164	6	20/40

- GB Hex key set
- D Sechskant-Stiftschlüsselsatz
- PL Zestaw kluczy imbusowych
- RUS Набор шестигранников

- CZ Imbusové klíče
- H Imbisz kulcs
- RO Chei imbus
- F Set de clés Allen

- I Set di chiavi a brugola
- E Juego de llaves hex
- CN 内六角扳手组套

PLASTIC HANGER & SLIDING CARD



12  
PCS

CrV  
6150

S.A.E.

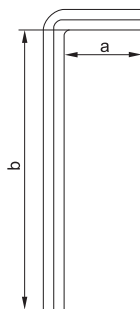

YATO	Hex	a (mm)	b (mm)	
YT-5835	1/16" (1.6 mm)	14	74	6/36
	5/64" (2.0 mm)	16	79	
	3/32" (2.4 mm)	17	83	
	7/64" (2.8 mm)	18	88	
	1/8" (3.2 mm)	19	93	
	9/64" (3.6 mm)	20	99	
	5/32" (4.0 mm)	21	105	
	3/16" (4.8 mm)	24	113	
	7/32" (5.6 mm)	25	122	
	1/4" (6.3 mm)	28	132	
	5/16" (7.9 mm)	32	150	
3/8" (9.5 mm)	35	170		

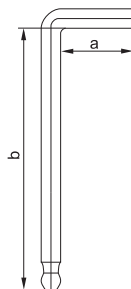

YATO	Hex	a (mm)	b (mm)	
YT-5837	1/16" (1.6 mm)	14	74	6/36
	5/64" (2.0 mm)	16	79	
	3/32" (2.4 mm)	17	83	
	7/64" (2.8 mm)	18	88	
	1/8" (3.2 mm)	19	93	
	9/64" (3.6 mm)	20	99	
	5/32" (4.0 mm)	21	105	
	3/16" (4.8 mm)	24	113	
	7/32" (5.6 mm)	25	122	
	1/4" (6.3 mm)	28	132	
	5/16" (7.9 mm)	32	150	
3/8" (9.5 mm)	35	170		



YATO	Hex	a (mm)	b (mm)	
YT-5838	1/16" (1.6 mm)	14	91	6/36
	5/64" (2.0 mm)	16	100	
	3/32" (2.4 mm)	17	110	
	7/64" (2.8 mm)	18	116	
	1/8" (3.2 mm)	19	123	
	9/64" (3.6 mm)	20	130	
	5/32" (4.0 mm)	21	132	
	3/16" (4.8 mm)	24	150	
	7/32" (5.6 mm)	25	165	
	1/4" (6.3 mm)	28	185	
	5/16" (7.9 mm)	32	200	
3/8" (9.5 mm)	35	233		

GB Hex key set  
D Sechskant-Stiftschlüsselsatz  
PL Zestaw kluczy imbusowych  
RUS Набор шестигранников

CZ Imbusové klíče  
H Imbisz kulcs  
RO Chei imbus  
F Set de clés Allen

I Set di chiavi a brugola  
E Juego de llaves hex  
CN 内六角扳手组套

PLASTIC HANGER & SLIDING CARD



HEX CrV 6150 HRC 52-55

5

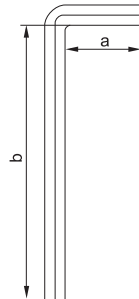

9 PCS

YATO	Ø (mm)	a (mm)	b (mm)	Box
YT-0500	1.5	15	74	6/36
	2.0	16	81	
	2.5	18	88	
	3.0	21	95	
	4.0	23	109	
	5.0	28	121	
	6.0	31	135	
	8.0	35	157	
	10.0	39	174	

9 PCS

YATO	Ø (mm)	a (mm)	b (mm)	Box
YT-0501	1.5	15	90	6/36
	2.0	16	96	
	2.5	18	112	
	3.0	21	125	
	4.0	23	142	
	5.0	28	157	
	6.0	31	180	
	8.0	35	201	
	10.0	39	225	

9 PCS

YATO	Ø (mm)	a (mm)	b (mm)	Box
YT-0502	2.0	16	81	6/36
	2.5	18	88	
	3.0	21	95	
	4.0	23	109	
	5.0	28	121	
	6.0	31	135	
	7.0	33	145	
	8.0	35	157	
	10.0	39	174	

10 PCS

YATO	Ø (mm)	a (mm)	b (mm)	Box
YT-0508	2.0	16	81	6/36
	2.5	18	88	
	3.0	21	95	
	4.0	23	109	
	5.0	28	121	
	6.0	31	135	
	7.0	33	145	
	8.0	35	157	
	10.0	39	174	
	12.0	42	180	

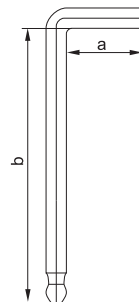

9 PCS

YATO	Ø (mm)	a (mm)	b (mm)	Box
YT-0505	1.5	15	74	6/36
	2.0	16	81	
	2.5	18	88	
	3.0	21	95	
	4.0	23	109	
	5.0	28	121	
	6.0	31	135	
	8.0	35	157	
	10.0	39	174	

9 PCS

YATO	Ø (mm)	a (mm)	b (mm)	Box
YT-0506	1.5	15	90	6/36
	2.0	16	96	
	2.5	18	112	
	3.0	21	125	
	4.0	23	142	
	5.0	28	157	
	6.0	31	180	
	8.0	35	201	
	10.0	39	225	

9 PCS

YATO	Ø (mm)	a (mm)	b (mm)	Box
YT-0507	2.0	16	81	6/36
	2.5	18	88	
	3.0	21	95	
	4.0	23	109	
	5.0	28	121	
	6.0	31	135	
	7.0	33	145	
	8.0	35	157	
	10.0	39	174	

10 PCS

YATO	Ø (mm)	a (mm)	b (mm)	Box
YT-0509	2.0	16	81	6/36
	2.5	18	88	
	3.0	21	95	
	4.0	23	109	
	5.0	28	121	
	6.0	31	135	
	7.0	33	145	
	8.0	35	157	
	10.0	39	174	
	12.0	42	180	

GB Hex key set  
D Sechskant-Stiftschlüsselsatz  
PL Zestaw kluczy imbusowych  
RUS Набор шестигранников

CZ Imbusové klíče  
H Imbisz kulcs  
RO Chei imbus  
F Set de clés Allen

I Set di chiavi a brugola  
E Juego de llaves hex  
CN 内六角扳手组套

POUCH



HEX CrV 6150

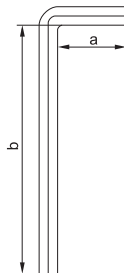

8 PCS

YATO	Ø (mm)	a (mm)	b (mm)	Box
YT-0503	2.0	14	50	12/72
	2.5	16	53	
	3.0	17	60	
	4.0	21	66	
	5.0	22	74	
	6.0	27	81	
	8.0	32	93	
	10.0	38	104	

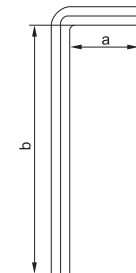

10 PCS

YATO	Ø (mm)	a (mm)	b (mm)	Box
YT-0504	1.5	12	43	12/72
	2.0	14	50	
	2.5	16	53	
	3.0	17	60	
	4.0	21	66	
	5.0	22	74	
	6.0	27	81	
	7.0	31	86	
	8.0	32	93	
	10.0	38	104	

- GB Hex key set
- D Sechskant-Stiftschlüsselsatz
- PL Zestaw kluczy imbusowych
- RUS Набор шестигранников
- CZ Imbusové klíče
- H Imbissz kulcs
- RO Chei imbus
- F Set de clés Allen
- I Set di chiavi a brugola
- E Juego de llaves hex
- CN 内六角扳手组套



10  
PCS



CrV  
6150

HRC  
52-55

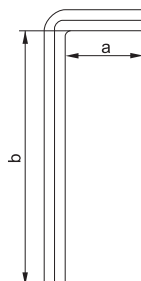

YATO	Ø (mm)	a (mm)	b (mm)	
YT-0519	3.0	20	125	5
	4.0	25	140	
	5.0	28	160	
	5.5	30	170	
	6.0	32	180	
	8.0	35	200	
	10.0	42	220	
	12.0	49	250	
	14.0	57	285	
17.0	65	320		

- GB TORX key set
- D TORX-Stiftschlüsselsatz
- PL Zestaw kluczy TORX
- RUS Набор ключей TORX
- CZ Souprava klíčů TORX
- H Kulcskészlet, TORX
- RO Set de chei TORX
- F Set de clés Allen
- I Set di chiavi a brugola
- E Juego de llaves TORX
- CN 内六角扳手组套

9  
PCS



CrV  
6150

HRC  
52-55

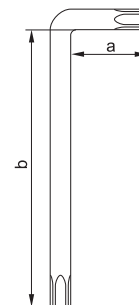

YATO	Ø	a (mm)	b (mm)	
YT-0511	T10	15	72	6/36
	T15	16	79	
	T20	17	86	
	T25	21	94	
	T27	24	107	
	T30	27	122	
	T40	32	133	
	T45	36	155	
	T50	38	174	

YATO	Ø	a (mm)	b (mm)	
YT-0512	T10	15	78	6/36
	T15	16	95	
	T20	19	109	
	T25	23	124	
	T27	26	143	
	T30	27	153	
	T40	32	180	
	T45	36	200	
	T50	41	222	

- GB Hex key set
- D Sechskant-Stiftschlüsselsatz
- PL Zestaw kluczy imbusowych
- RUS Набор шестигранников
- CZ Imbusové klíče
- H Imbissz kulcs
- RO Chei imbus
- F Set de clés Allen
- I Set di chiavi a brugola
- E Juego de llaves hex
- CN 内六角扳手组套

PLASTIC HANGER



S2

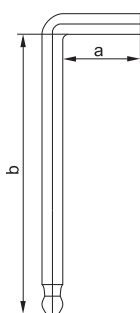

10  
PCS

10  
PCS

YATO	Ø (mm)	a (mm)	b (mm)	
YT-0560	1.27	12	73	12/48
	1.5	14	76	
	2.0	16	82	
	2.5	18	89	
	3.0	18	99	
	4.0	21	104	
	5.0	27	115	
	6.0	32	138	
	8.0	35	161	
	10.0	38	179	

YATO	Ø (mm)	a (mm)	b (mm)	
YT-0561	1.27	10	78	12/48
	1.5	12	89	
	2.0	15	98	
	2.5	17	110	
	3.0	19	124	
	4.0	23	140	
	5.0	28	159	
	6.0	32	179	
	8.0	36	198	
	10.0	50	232	

- GB TORX key set
- D TORX-Stiftschlüsselsatz
- PL Zestaw kluczy TORX
- RUS Набор ключей TORX
- CZ Souprava klíčů TORX
- H Kulcskészlet, TORX
- RO Set de chei TORX
- F Set de clés Allen
- I Set di chiavi a brugola
- E Juego de llaves TORX
- CN 内六角扳手组套



PLASTIC HANGER



S2

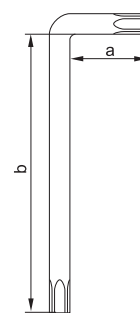

7  
PCS

9  
PCS

YATO	Ø	a (mm)	b (mm)	
YT-0562	T9	18	78	12/48
	T10	19	85	
	T15	19	93	
	T20	19	103	
	T25	22	113	
	T27	24	123	
	T30	26	132	

YATO	Ø	a (mm)	b (mm)	
YT-0563	T10	14	87	12/48
	T15	14	97	
	T20	16	108	
	T25	18	123	
	T27	23	137	
	T30	27	158	
	T40	30	177	
	T45	35	197	
	T50	41	216	

# 6

## Pliers & pipe wrenches Szczypce i klucze do rur



**Pliers, CrV**  
**Szczypce, CrV**



121

Combination pliers	121
Szczypce uniwersalne	121
Side cutting pliers	
Szczypce tnące, boczne	121
Long nose pliers	
Szczypce wydłużone, proste	121
Bent nose pliers	
Szczypce wydłużone, wygięte	121

**Pliers**  
**Szczypce**



121-122

Combination pliers	
Szczypce uniwersalne	121
Side cutting pliers	
Szczypce tnące, boczne	121
Long nose pliers	
Szczypce wydłużone, proste	121
Bent nose pliers	
Szczypce wydłużone, wygięte	121
Flat nose pliers	
Szczypce płaskie	122
Round nose pliers	
Szczypce okrągłe	122
Wire stripping pliers	
Szczypce do ściągania izolacji	122
End cutting pliers	
Szczypce tnące, czołowe	122

**Pliers, CrV**  
**Szczypce, CrV**



122

Combination pliers	
Szczypce uniwersalne	122
Side cutting pliers	
Szczypce tnące, boczne	122

**Pliers**  
**Szczypce**



123

Combination pliers	
Szczypce uniwersalne	123
Side cutting pliers	
Szczypce tnące, boczne	123
Long nose pliers	
Szczypce wydłużone, proste	123

**Mini pliers**  
**Szczypce „Mini”**



124

Combination pliers	
Szczypce uniwersalne	124
Side cutting pliers	
Szczypce tnące, boczne	124
Long nose pliers	
Szczypce wydłużone, proste	124
Bent nose pliers	
Szczypce wydłużone, wygięte	124
Flat nose pliers	
Szczypce płaskie	124
Round nose pliers	
Szczypce okrągłe	124

End cutting pliers	
Szczypce tnące, czołowe	124

**Pliers, CrV**  
**Szczypce, CrV**



125

Combination pliers	
Szczypce uniwersalne	125
Long nose pliers	
Szczypce wydłużone, proste	125

**Insulated pliers**  
**Szczypce izolowane**



126

Combination pliers	
Szczypce uniwersalne	126
Side cutting pliers	
Szczypce tnące, boczne	126
Long nose pliers	
Szczypce wydłużone, proste	126
Bent nose pliers	
Szczypce wydłużone, wygięte	126
Wire stripping pliers	
Szczypce do ściągania izolacji	126

**Plastics & cables cutting pliers**  
**Szczypce do cięcia plastiku i kabli**



127

Side cutting pliers	
Szczypce tnące, boczne	127
Long nose pliers	
Szczypce wydłużone, proste	127

**Carpenter's pliers & tower pincers**  
**Obcęgi i szczypce**



128

Carpenter's pliers	
Obcęgi	128
Tower pincers	
Szczypce tynkarskie	128

**Heavy duty side cutting pliers**  
**Szczypce tnące, boczne**



128

End cutting pliers	
Szczypce tnące czołowe	128

**Circlip pliers**  
**Szczypce Segera**



129-130



**Lock grip pliers**  
**Szczypce zaciskowe**



131-133

Lock grip pliers	
Szczypce zaciskowe, uniwersalne	131



<p><b>Welding locking pliers</b>                  Szczypce zaciskowe, spawalnicze..... 132</p> <p><b>Flat locking pliers</b>                  Szczypce zaciskowe o szerokich szczękach..... 132</p> <p><b>C-type welding locking pliers</b>                  Szczypce zaciskowe, klamrowe typu „C”..... 132</p> <p><b>Chain locking pliers</b>                  Szczypce zaciskowe z łańcuchem..... 132</p> <p><b>Self-locking multi grip pliers</b>                  Szczypce blacharskie..... 133</p>	<p><b>Pipe wrenches</b>                  Klucze do rur..... 134</p> <p><b>Chain pipe wrenches</b>                  Klucze do rur łańcuchowe..... 134</p>	
<p><b>Profile connection &amp; forming pliers</b>                  Szczypce do łączenia i kształtowania profili..... 133</p>	<p><b>Tweezers</b>                  Pęsety..... 135</p>	
<p><b>Water pump pliers</b>                  Szczypce nastawne..... 134</p>		



GB Combination pliers  
D Kombinationszange  
PL Szczypce uniwersalne  
RUS Плоскогубцы универсальные  
CZ Kleště kombinované  
H Kombináltfogó

RO Patent universal  
F Pince universelle  
I Pinze universali  
E Alicates universales  
CN 钢丝钳

160 mm	180 mm	200 mm
HRC 44-50 BODY	HRC 58-62 CUTTER	CrV 55
DIN 5746		



HALF DOUBLE BLISTER

- application: industry
- induction hardening

- przeznaczenie: przemysł
- hartowane indukcyjnie

YATO	L (mm)	
YT-1940	160	6/60
YT-1941	180	6/60
YT-1942	200	6/36

GB Diagonal side cutting pliers  
D Seitenschneider  
PL Szczypce tnące boczne  
RUS Бокорезы  
CZ Řezací kleště boční  
H Oldal csípőfogó

RO Olește tăietor  
F Pince à coupe latérale  
I Pinze taglianti laterali  
E Alicates corte lateral  
CN 斜嘴钳

160 mm	190 mm	HRC 44-50 BODY
HRC 58-62 CUTTER	CrV 55	DIN 5746

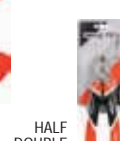

HALF DOUBLE BLISTER

- application: industry
- induction hardening

- przeznaczenie: przemysł
- hartowane indukcyjnie

YATO	L (mm)	
YT-1947	160	6/60
YT-1948	190	6/60

GB Long nose pliers  
D Radiozange  
PL Szczypce wydłużone proste  
RUS Тонкогубцы прямые  
CZ Prodloužené kleště rovné  
H Rádiófogó, egyenes

RO Clește cu vârf ascuțit  
F Pince prolongée  
I Pinze lunghe diritte  
E Alicates de punta  
CN 尖嘴钳

160 mm	200 mm	HRC 44-50 BODY
HRC 58-62 CUTTER	CrV 55	DIN 5746



HALF DOUBLE BLISTER

- application: industry
- induction hardening

- przeznaczenie: przemysł
- hartowane indukcyjnie

YATO	L (mm)	
YT-1943	160	6/60
YT-1944	200	6/60

GB Bent nose pliers  
D Telefonzange  
PL Szczypce wydłużone wygięte  
RUS Тонкогубцы изогнутые  
CZ Prodloužené kleště ohnuté  
H Rádió - és telefonfogó, hajlított

RO Clește cu vârf ascuțit indoit  
F Pince prolongée cambrée  
I Pinze a punte mezzo tonde  
E Alicates de punta curvos  
CN 弯嘴钳

160 mm	200 mm	HRC 44-50 BODY
HRC 58-62 CUTTER	CrV 55	DIN 5746



HALF DOUBLE BLISTER

- application: industry
- induction hardening

- przeznaczenie: przemysł
- hartowane indukcyjnie

YATO	L (mm)	
YT-1945	160	6/60
YT-1946	200	6/60

GB Combination pliers  
D Kombinationszange  
PL Szczypce uniwersalne  
RUS Плоскогубцы универсальные  
CZ Kleště kombinované  
H Kombináltfogó

RO Patent universal  
F Pince universelle  
I Pinze universali  
E Alicates universales  
CN 钢丝钳

160 mm	180 mm	200 mm
DIN 5746		NICKEL IRON FINISH



HALF DOUBLE BLISTER

YATO	L (mm)	
YT-2006	160	6/60
YT-2007	180	6/60
YT-2008	200	6/36

GB Diagonal side cutting pliers  
D Seitenschneider  
PL Szczypce tnące boczne  
RUS Бокорезы  
CZ Řezací kleště boční  
H Oldal csípőfogó

RO Olește tăietor  
F Pince à coupe latérale  
I Pinze taglianti laterali  
E Alicates corte lateral  
CN 斜嘴钳

160 mm	180 mm	
DIN 5746		NICKEL IRON FINISH

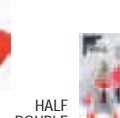

HALF DOUBLE BLISTER

YATO	L (mm)	
YT-2036	160	6/60
YT-2037	180	6/60

GB Long nose pliers  
D Radiozange  
PL Szczypce wydłużone proste  
RUS Тонкогубцы прямые  
CZ Prodloužené kleště rovné  
H Rádiófogó, egyenes

RO Clește cu vârf ascuțit  
F Pince prolongée  
I Pinze lunghe diritte  
E Alicates de punta  
CN 尖嘴钳

160 mm	200 mm	
DIN 5746		NICKEL IRON FINISH



HALF DOUBLE BLISTER

YATO	L (mm)	
YT-2016	160	6/60
YT-2018	200	6/60

GB Bent nose pliers  
D Telefonzange  
PL Szczypce wydłużone wygięte  
RUS Тонкогубцы изогнутые  
CZ Prodloužené kleště ohnuté  
H Rádió - és telefonfogó, hajlított

RO Clește cu vârf ascuțit indoit  
F Pince prolongée cambrée  
I Pinze a punte mezzo tonde  
E Alicates de punta curvos  
CN 弯嘴钳

160 mm	200 mm	
DIN 5746		NICKEL IRON FINISH



HALF DOUBLE BLISTER

YATO	L (mm)	
YT-2026	160	6/60
YT-2028	200	6/60

- GB Flat nose pliers  
 D Elektrikerflachzange  
 PL Szczypce płaskie  
 RUS Утконосы  
 CZ Prodloužené kleště rovné  
 H Rádiófogó, egyenes
- RO Clește cu vârf ascuțit  
 F Pince plate  
 I Pinze piatte  
 E Alicates de bocas planas  
 CN 平嘴钳

**160 mm** **DIN 5745** **NICKEL IRON FINISH**



HALF DOUBLE BLISTER

YATO	L (mm)	
YT-2029	160	6/60

- GB Round nose pliers  
 D Rundzange  
 PL Szczypce okrągłe  
 RUS Круглогубцы  
 CZ Kleště kulaté  
 H Kerekcsőrű fogó
- RO Patent rotund  
 F Pince ronde  
 I Pinze tonde  
 E Alicates de punta redonda  
 CN 圆嘴钳

**160 mm** **DIN 5745** **NICKEL IRON FINISH**



HALF DOUBLE BLISTER

YATO	L (mm)	
YT-2030	160	6/60

- GB Wire stripping pliers  
 D Abisolierzange  
 PL Szczypce do ściągania izolacji  
 RUS Пасатижи для зачистки проводов  
 CZ Kleště odizolovací na drát  
 H Blankoló fogó  
 RO Decablator
- F Pince à l'isolation  
 I Pinze spelafili  
 E Pinzas pelacables  
 CN 剥线钳

**160 mm** **DIN 5745** **NICKEL IRON FINISH**



HALF DOUBLE BLISTER

YATO	L (mm)	
YT-2031	160	6/60

- GB End cutting pliers  
 D Vornscheider  
 PL Szczypce tnące czolowe  
 RUS Кусачки торцевые  
 CZ Kleště štípací čelní  
 H Homlokcsipő fogó  
 RO Cleste rețezat
- F Coupe devant  
 I Pinza a taglio laterale  
 E Cortacables frontales  
 CN 顶切钳

**160 mm** **180 mm**

**DIN 5748** **NICKEL IRON FINISH**



HALF DOUBLE BLISTER

YATO	L (mm)	
YT-2066	160	6/60
YT-2067	180	6/60

- GB Combination pliers  
 D Kombinationszange  
 PL Szczypce uniwersalne  
 RUS Плоскогубцы универсальные  
 CZ Kleště kombinované  
 H Kombináltfogó
- RO Patent universal  
 F Pince universelle  
 I Pinze universali  
 E Alicates universales  
 CN 钢丝钳

**160 mm** **180 mm** **200 mm**

**CrV** **HRC 55-62**



HALF DOUBLE BLISTER

YATO	L (mm)	
YT-6600	160	6/60
YT-6601	180	6/60
YT-6602	200	6/36

- GB Diagonal side cutting pliers  
 D Seitenschneider  
 PL Szczypce tnące boczne  
 RUS Бокорезы  
 CZ Řezací kleště boční  
 H Oldal csipőfogó
- RO Olește tăietor  
 F Pince à coupe latérale  
 I Pinze taglienti laterali  
 E Alicates corte lateral  
 CN 斜嘴钳

**160 mm** **180 mm**

**CrV** **HRC 55-62**



HALF DOUBLE BLISTER

YATO	L (mm)	
YT-6610	160	6/60
YT-6611	180	6/60

- GB Diagonal side cutting pliers  
 D Seitenschneider  
 PL Szczypce tnące boczne  
 RUS Бокорезы  
 CZ Řezací kleště boční  
 H Oldal csipőfogó  
 RO Olește tăietor  
 F Pince à coupe latérale  
 I Pinze taglienti laterali  
 E Alicates corte lateral  
 CN 斜嘴钳

**180 mm** **CrV** **HRC 55-62**



HALF DOUBLE BLISTER

YATO	L (mm)	
YT-6612	180	6/60

- GB Combination pliers  
D Kombinationszange  
PL Szczypce uniwersalne  
RUS Плоскогубцы универсальные  
CZ Kleště kombinované  
H Kombináltfogó
- RO Patent universal  
F Pince universelle  
I Pinze universali  
E Alicates universales  
CN 钢丝钳



160  
mm

200  
mm

HIGH  
LEVERAGE  
ZWIĘKSZONA  
SIŁA NACISKU



HALF  
DOUBLE  
BLISTER

YATO 	L (mm)	
YT-6581	160	6/60
YT-6582	200	6/36

6



- GB Diagonal side cutting pliers  
D Seitenschneider  
PL Szczypce tnące boczne  
RUS Бокорезы  
CZ Řezací kleště boční  
H Oldal csípőfogó
- RO Olește tăietor  
F Pince à coupe latérale  
I Pinze taglianti laterali  
E Alicates corte lateral  
CN 斜嘴钳

160  
mm

HIGH  
LEVERAGE  
ZWIĘKSZONA  
SIŁA NACISKU



HALF  
DOUBLE  
BLISTER

YATO 	L (mm)	
YT-6583	160	6/60

- GB Long nose pliers  
D Radiozange  
PL Szczypce wydłużone proste  
RUS Тонкогубцы прямые  
CZ Prodloužené kleště rovné  
H Rádiófogó, egyenes
- RO Clește cu vârf ascuțit  
F Pince prolongée  
I Pinze lunghe diritte  
E Alicates de punta  
CN 尖嘴钳



160  
mm

200  
mm

HIGH  
LEVERAGE  
ZWIĘKSZONA  
SIŁA NACISKU



HALF  
DOUBLE  
BLISTER

YATO 	L (mm)	
YT-6586	160	6/60
YT-6587	200	6/36

GB Combination pliers  
D Kombinationszange  
PL Szczypce uniwersalne  
RUS Плоскогубцы универсальные  
CZ Kleště kombinované  
H Kombináltfogó  
RO Patent universal  
F Pince universelle

I Pinze universali  
E Alicates universales  
CN 钢丝钳

115 mm

NICKEL IRON FINISH



HALF DOUBLE BLISTER

YATO L (mm) 115 6/120

GB Diagonal side cutting pliers  
D Seitenschneider  
PL Szczypce tnące boczne  
RUS Бокорезы  
CZ Řezací kleště boční  
H Oldal csípőfogó  
RO Olește tăietor  
F Pince à coupe latérale

I Pinze taglianti laterali  
E Alicates corte lateral  
CN 斜嘴钳

115 mm

NICKEL IRON FINISH



HALF DOUBLE BLISTER

YATO L (mm) 115 6/120

GB Long nose pliers  
D Radiozange  
PL Szczypce wydłużone proste  
RUS Тонкогубцы прямые  
CZ Prodloužené kleště rovné  
H Rádiófogó, egyenes

RO Clește cu vârf ascuțit  
F Pince prolongée  
I Pinze lunghe diritte  
E Alicates de punta  
CN 尖嘴钳

115 mm

NICKEL IRON FINISH



HALF DOUBLE BLISTER

YATO L (mm) 115 6/120

GB Bent nose pliers  
D Telefonzange  
PL Szczypce wydłużone wygięte  
RUS Тонкогубцы изогнутые  
CZ Prodloužené kleště ohnuté  
H Rádió - és telefonfogó, hajlítót

RO Clește cu vârf ascuțit îndoit  
F Pince prolongée cambrée  
I Pinze a punte mezzo tonde  
E Alicates de punta curvos  
CN 弯嘴钳

115 mm

NICKEL IRON FINISH



HALF DOUBLE BLISTER

YATO L (mm) 115 6/120

GB Flat nose pliers  
D Elektrikerflachzange  
PL Szczypce płaskie  
RUS Утконосы  
CZ Prodloužené kleště rovné  
H Rádiófogó, egyenes

RO Clește cu vârf ascuțit  
F Pince plate  
I Pinze piatte  
E Alicates de bocas planas  
CN 平嘴钳

115 mm

NICKEL IRON FINISH



HALF DOUBLE BLISTER

YATO L (mm) 115 6/120

GB Round nose pliers  
D Rundzange  
PL Szczypce okrągłe  
RUS Круглогубцы  
CZ Kleště kulaté  
H Kerekcsőrű fogó

RO Patent rotund  
F Pince ronde  
I Pinze tonde  
E Alicates de punta redonda  
CN 圆嘴钳

115 mm

NICKEL IRON FINISH



HALF DOUBLE BLISTER

YATO L (mm) 115 6/120

GB End cutting pliers  
D Vornschnaider  
PL Szczypce tnące czolowe  
RUS Кусачки торцевые  
CZ Kleště štípací čelní  
H Homlokcsípő fogó  
RO Clește retezat  
F Coupe devant  
I Pinza a taglio laterale  
E Cortacables frontales  
CN 顶切钳



115 mm

NICKEL IRON FINISH

HALF DOUBLE BLISTER

YATO L (mm) 115 6/120

GB Combination pliers  
D Kombinationszange  
PL Szcypce uniwersalne  
RUS Плоскогубцы универсальные  
CZ Kleště kombinované  
H Kombináltfogó



RO Patent universal  
F Pince universelle  
I Pinze universali  
E Alicates universales  
CN 钢丝钳

160 mm 200 mm CrV HRC 56-62



SLIDING CARD



YATO 	L (mm)	
YT-6620	160	6/60
YT-6622	200	6/36

6

GB Long nose pliers  
D Radiozange  
PL Szcypce wydłużone proste  
RUS Тонкогубцы прямые  
CZ Prodloužené kleště rovné  
H Rádiófogó, egyenes



RO Clește cu vârf ascuțit  
F Pince prolongée  
I Pinze lunghe diritte  
E Alicates de punta  
CN 尖嘴钳

200 mm CrV HRC 56-62



SLIDING CARD



YATO 	L (mm)	
YT-6624	200	6/36

GB Long nose pliers  
D Radiozange  
PL Szcypce wydłużone proste  
RUS Тонкогубцы прямые  
CZ Prodloužené kleště rovné  
H Rádiófogó, egyenes



RO Clește cu vârf ascuțit  
F Pince prolongée  
I Pinze lunghe diritte  
E Alicates de punta  
CN 尖嘴钳

160 mm CrV HRC 56-62



SLIDING CARD



YATO 	L (mm)	
YT-6625	160	6/60

GB Long nose pliers  
D Radiozange  
PL Szcypce wydłużone proste  
RUS Тонкогубцы прямые  
CZ Prodloužené kleště rovné  
H Rádiófogó, egyenes



RO Clește cu vârf ascuțit  
F Pince prolongée  
I Pinze lunghe diritte  
E Alicates de punta  
CN 尖嘴钳

160 mm CrV HRC 56-62



SLIDING CARD



YATO 	L (mm)	
YT-6626	160	6/60

- GB Combination pliers
- D Kombinationszange
- PL Szczypce uniwersalne
- RUS Плоскогубцы универсальные
- CZ Kleště kombinované
- H Kombináltfogó
- RO Patent universal
- F Pince universelle
- I Pinze universali
- E Alicates universales
- CN 钢丝钳

**160 mm** **180 mm** **200 mm** **1000 V** **DIN 5746** **CrV**



05 VDE  
CERTIFICATE  
-IEC60900:2004

HALF  
DOUBLE  
BLISTER

YATO	L (mm)	
YT-2101	160	6/60
YT-2102	180	6/60
YT-2103	200	6/60

- GB Diagonal side cutting pliers
- D Seitenschneider
- PL Szczypce tnące boczne
- RUS Бокорезы
- CZ Řezací kleště boční
- H Oldal csípőfogó
- RO Olește tăietor
- F Pince à coupe latérale
- I Pinze taglianti laterali
- E Alicates corte lateral
- CN 斜嘴钳

**160 mm** **1000 V** **DIN 5749** **CrV**



05 VDE  
CERTIFICATE  
-EN60900:2004

HALF  
DOUBLE  
BLISTER

YATO	L (mm)	
YT-2109	160	6/60

- GB Diagonal side cutting pliers
- D Seitenschneider
- PL Szczypce tnące boczne
- RUS Бокорезы
- CZ Řezací kleště boční
- H Oldal csípőfogó
- RO Olește tăietor
- F Pince à coupe latérale
- I Pinze taglianti laterali
- E Alicates corte lateral
- CN 斜嘴钳

**180 mm** **1000 V** **DIN 5749** **CrV**



05 VDE  
CERTIFICATE  
-EN60900:2004

HALF  
DOUBLE  
BLISTER

YATO	L (mm)	
YT-2110	180	6/60

- GB Long nose pliers
- D Radiozange
- PL Szczypce wydłużone proste
- RUS Тонкогубцы прямые
- CZ Prodloužené kleště rovné
- H Rádiófogó, egyenes
- RO Clește cu vârf ascuțit
- F Pince prolongée
- I Pinze lunghe diritte
- E Alicates de punta
- CN 尖嘴钳

**160 mm** **200 mm** **1000 V** **DIN 5745** **CrV**



05 VDE  
CERTIFICATE  
-EN60900:2004

HALF  
DOUBLE  
BLISTER

YATO	L (mm)	
YT-2104	160	6/60
YT-2105	200	6/60

- GB Bent nose pliers
- D Telefonzange
- PL Szczypce wydłużone wygięte
- RUS Тонкогубцы изогнутые
- CZ Prodloužené kleště ohnuté
- H Rádió - és telefonfogó, hajlított
- RO Clește cu vârf ascuțit îndoit
- F Pince prolongée cambrée
- I Pinze a punte mezzo tonde
- E Alicates de punta curvos
- CN 弯嘴钳

**200 mm** **1000 V** **DIN 5745** **CrV**



05 VDE  
CERTIFICATE  
-EN60900:2004

HALF  
DOUBLE  
BLISTER

YATO	L (mm)	
YT-2107	200	6/60

- GB Wire stripping pliers
- D Abisolierzange
- PL Szczypce do ściągania izolacji
- RUS Пасатижи для зачистки проводов
- CZ Kleště odizolovací na drát
- H Blankoló fogó
- RO Decablator
- F Pince à l'isolation
- I Pinze spelafili
- E Pinzas pelacables
- CN 剥线钳

**160 mm** **1000 V** **DIN 5745** **CrV**



05 VDE  
CERTIFICATE  
-EN60900:2004

HALF  
DOUBLE  
BLISTER

YATO	L (mm)	
YT-2112	160	6/60

GB Diagonal side cutting pliers  
D Seitenschneider  
PL Szczypce tnące boczne  
RUS Бокорезы  
CZ Řezací kleště boční  
H Oldal csípőfogó

RO Oleşte tăietor  
F Pince à coupe latérale  
I Pinze taglianti laterali  
E Alicates corte lateral  
CN 斜嘴钳

**125 mm**  
**CrV 60**  
**HRC CUTTER 56-62**  
**HRC BODY 43-48**  
**FOR PLASTIC**  
max.  $\varnothing$  **3 mm**



SLIDING CARD

**YATO** L (mm)   
YT-1950 125 6/120

GB Diagonal side cutting pliers  
D Seitenschneider  
PL Szczypce tnące boczne  
RUS Бокорезы  
CZ Řezací kleště boční  
H Oldal csípőfogó

RO Oleşte tăietor  
F Pince à coupe latérale  
I Pinze taglianti laterali  
E Alicates corte lateral  
CN 斜嘴钳

**150 mm**  
**CrV 60**  
**HRC CUTTER 56-62**  
**HRC BODY 43-48**  
**FOR PLASTIC**  
max.  $\varnothing$  **5 mm**



SLIDING CARD

**YATO** L (mm)   
YT-1951 150 6/120

GB Diagonal side cutting pliers  
D Seitenschneider  
PL Szczypce tnące boczne  
RUS Бокорезы  
CZ Řezací kleště boční  
H Oldal csípőfogó

RO Oleşte tăietor  
F Pince à coupe latérale  
I Pinze taglianti laterali  
E Alicates corte lateral  
CN 斜嘴钳

**180 mm**  
**CrV 60**  
**HRC CUTTER 56-62**  
**HRC BODY 43-48**  
**FOR PLASTIC**  
max.  $\varnothing$  **6 mm**



SLIDING CARD

**YATO** L (mm)   
YT-1952 180 6/60

GB Diagonal side cutting pliers  
D Seitenschneider  
PL Szczypce tnące boczne  
RUS Бокорезы  
CZ Řezací kleště boční  
H Oldal csípőfogó

RO Oleşte tăietor  
F Pince à coupe latérale  
I Pinze taglianti laterali  
E Alicates corte lateral  
CN 斜嘴钳

**100 mm**  
**CrV 60**  
**HRC CUTTER 56-62**  
**HRC BODY 43-48**  
**FOR CABLE CUTTING**  
**STEEL max.  $\varnothing$  1.0 mm**  
**COPPER max.  $\varnothing$  1.8 mm**



SLIDING CARD

**YATO** L (mm)   
YT-1953 100 6/120

GB Diagonal side cutting pliers  
D Seitenschneider  
PL Szczypce tnące boczne  
RUS Бокорезы  
CZ Řezací kleště boční  
H Oldal csípőfogó

RO Oleşte tăietor  
F Pince à coupe latérale  
I Pinze taglianti laterali  
E Alicates corte lateral  
CN 斜嘴钳

**125 mm**  
**CrV 60**  
**HRC CUTTER 56-62**  
**HRC BODY 43-48**  
**FOR CABLE CUTTING**  
**STEEL max.  $\varnothing$  1.2 mm**  
**COPPER max.  $\varnothing$  2.0 mm**



SLIDING CARD

**YATO** L (mm)   
YT-1954 125 6/120

GB Long nose pliers  
D Radiozange  
PL Szczypce wydłużone proste  
RUS Тонкогубцы прямые  
CZ Prodloužené kleště rovné  
H Rádiófogó, egyenes

RO Cleşte cu vârf ascuțit  
F Pince prolongée  
I Pinze lunghe diritte  
E Alicates de punta  
CN 尖嘴钳

**150 mm**  
**CrV 60**  
**HRC CUTTER 56-62**  
**HRC BODY 43-48**  
**STEEL max.  $\varnothing$  1.5 mm**  
**COPPER max.  $\varnothing$  2.6 mm**

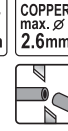

SLIDING CARD

**YATO** L (mm)   
YT-1956 150 6/120

GB Carpenter's pliers  
D Kneifzange  
PL Obcegi  
RUS Клещи строительные

CZ Kleště  
H Harapófógó  
RO Cleste cuie  
F Tenailles

I Tenaglie  
E Tenazas  
CN 胡桃钳

160 mm 180 mm 200 mm DIN 5748 NICKEL IRON FINISH



HALF DOUBLE BLISTER



YATO	L (mm)	
YT-2046	160	6/60
YT-2047	180	6/60
YT-2048	200	6/60

GB Tower pincers  
D Beisszange  
PL Obcegi tynkarskie  
RUS Клещи штукатурные

CZ Kleště štípací čelní  
H Rabitzfógó  
RO Cleste pt. cuie  
F Tenaille russe

I Tenaglie tronchesi  
E Tenazas de enlucido  
CN 扎线钳

200 mm 250 mm 275 mm DIN 5748 NICKEL IRON FINISH



HALF DOUBLE BLISTER



YATO	L (mm)	
YT-2058	200	6/60
YT-2060	250	6/36
YT-2061	275	6/36

GB Tower pincers  
D Beisszange  
PL Obcegi tynkarskie  
RUS Клещи штукатурные

CZ Kleště štípací čelní  
H Rabitzfógó  
RO Cleste pt. cuie  
F Tenaille russe

I Tenaglie tronchesi  
E Tenazas de enlucido  
CN 扎线钳

250 mm HRC 44-50 BODY HRC 58-62 CUTTER CrV 55 DIN 5746



HALF DOUBLE BLISTER



YATO	L (mm)	
YT-1949	250	6/36

GB Heavy duty side cutting pliers  
D Seitenschneider, Schwer Typ  
PL Szczypce tnące boczne  
RUS Бокорезы усиленные  
CZ Řezací kleště boční

H Oldal csípófógó  
RO Olește tăietor  
F Pince à coupe latérale  
I Pinze taglianti laterali

E Alicates de corte lateral tipo pesado  
CN 重型斜口钳

180 mm DIN 5749 NICKEL IRON FINISH



HALF DOUBLE BLISTER



YATO	L (mm)	
YT-2039	180	6/60

GB Carpenter's pliers  
D Kneifzange  
PL Obcegi  
RUS Клещи строительные

CZ Kleště  
H Harapófógó  
RO Cleste cuie  
F Tenailles

I Tenaglie  
E Tenazas  
CN 胡桃钳

150 mm 175 mm 200 mm CrV 50 HRC 55-60



SLIDING CARD



YATO	L (mm)	co ro e ta wa cowa na ta (mm)	tee (mm) imno (mm)	
YT-2050	150		1.5	6/60
YT-2051	175		1.8	6/60
YT-2052	200		2.0	6/48

GB Tower pincers  
D Beisszange  
PL Obcegi tynkarskie  
RUS Клещи штукатурные

CZ Kleště štípací čelní  
H Rabitzfógó  
RO Cleste pt. cuie  
F Tenaille russe

I Tenaglie tronchesi  
E Tenazas de enlucido  
CN 扎线钳

225 mm 250 mm 275 mm CrV 50 HRC 55-62



SLIDING CARD



YATO	L (mm)	co ro e ta wa cowa na ta (mm)	tee (mm) imno (mm)	
YT-2055	225		1.8	6/60
YT-2056	250		2.0	6/48
YT-2057	275		2.2	6/24

GB End cutting pliers  
D Vornschneider  
PL Szczypce tnące czolowe

RUS Кусачки торцевые  
CZ Kleště štípací čelní  
H Homlokcsípó fogó

RO Cleste retezat  
F Coupe devant  
I Pinza a taglio laterale

E Cortacables frontales  
CN 顶切钳

150 mm 175 mm 200 mm CrV 50 HRC 55-60



SLIDING CARD



YATO	L (mm)	co ro e ta wa cowa na ta (mm)	tee (mm) imno (mm)	
YT-2063	175		1.5	6/48
YT-2064	200		1.8	6/48



- |                             |                                       |
|-----------------------------|---------------------------------------|
| GB Circlip pliers           | F Pince pour anneau de retenue seeger |
| D Seegeringgzange           | I Pinze Seger                         |
| PL Szczypce Segera          | E Alicates Seger                      |
| RUS Съёмник стопорных колец | CN 5件套卡簧钳                             |
| CZ Kleště Segera            |                                       |
| H Segerfogó belső           |                                       |
| RO Clește Seger             |                                       |

5 PCS	160 mm	∅ mm 10-50



		23 mm max.		20 mm max.
		28 mm max.		23 mm max.
		30 mm max.		27 mm max.



SLIDING CARD

<b>YATO</b>	L (mm)	
YT-2130	160	20/60

6

- |                             |                                       |
|-----------------------------|---------------------------------------|
| GB Circlip pliers           | RO Clește Seger                       |
| D Seegeringgzange           | F Pince pour anneau de retenue seeger |
| PL Szczypce Segera          | I Pinze Seger                         |
| RUS Съёмник стопорных колец | E Alicates Seger                      |
| CZ Kleště Segera            | CN 直嘴轴用挡圈钳                            |
| H Segerfogó belső           |                                       |

SLIDING CARD



180 mm	HRC 42-48	CrV 50
-----------	--------------	-----------



<b>YATO</b>	L (mm)	
YT-2136	180	6/24



<b>YATO</b>	L (mm)	
YT-2138	180	6/24



<b>YATO</b>	L (mm)	
YT-2137	180	6/24



<b>YATO</b>	L (mm)	
YT-2139	180	6/24

GB Circlip pliers  
 D Seegeringgzange  
 PL Szczypce Segera  
 RUS Съёмник стопорных колец  
 CZ Kleště Segera  
 H Seegerfogó belső  
 RO Clește Seger  
 F Pince pour anneau de retenue seeger  
 I Pinze Seger  
 E Alicates Seger  
 CN 直嘴轴用挡圈钳

SLIDING CARD



**150 mm**  
**200 mm**  
**CrV**  
**NICKEL IRON FINISH**



YATO	L (mm)	
YT-2140	150	6/120
YT-2144	200	6/60



YATO	L (mm)	
YT-2141	150	6/120
YT-2145	200	6/60



YATO	L (mm)	
YT-2142	150	6/60
YT-2146	200	6/60



YATO	L (mm)	
YT-2143	150	6/120
YT-2147	200	6/60

GB Circlip pliers  
 D Seegeringgzange  
 PL Szczypce Segera  
 RUS Съёмник стопорных колец  
 CZ Kleště Segera  
 H Seegerfogó belső  
 RO Clește Seger  
 F Pince pour anneau de retenue seeger  
 I Pinze Seger  
 E Alicates Seger  
 CN 直嘴轴用挡圈钳

SLIDING CARD



**225 mm**  
**325 mm**  
**NICKEL FINISH**  
**CrV**



YATO	L (mm)	
YT-1988	225	6/60
YT-1992	325	6/48



YATO	L (mm)	
YT-1989	225	6/60
YT-1993	325	6/48



YATO	L (mm)	
YT-1990	225	6/60
YT-1994	325	6/48



YATO	L (mm)	
YT-1991	225	6/60
YT-1995	325	6/48

GB Lock grip pliers  
D Gripzange  
PL Szczypce Morse'a  
RUS Зажим ручной  
CZ Kleště Morse'a  
H Morse fogó

RO Clește Morse  
F Pincés de serrage Morse  
I Pinze Morse  
E Alicates Morse  
CN 圓口大力鉗

HALF  
DOUBLE  
BLISTER



140  
mm

240  
mm

180  
mm

WR  
TYPE



165  
mm

220  
mm

CD  
TYPE

YATO	L (mm)	
YT-2151	140	6/48
YT-2152	180	6/36
YT-2153	240	6/36

YATO	L (mm)	
YT-2155	165	6/48
YT-2156	220	6/36

GB Locking pliers  
D Klemmzange  
PL Szczypce zaciskowe  
RUS Клещи давящие  
CZ Kleště samosvorné  
H Patentfogó

RO Clește de strângere  
F Pincés de serrage Morse  
I Pinze Morse  
E Pinzas de tornillo (de apriete)  
CN 圓口大力鉗

HALF  
DOUBLE  
BLISTER



125  
mm



250  
mm

YATO	L (mm)	
YT-2449	125	6/24

YATO	L (mm)	
YT-2453	250	6/24



180  
mm



150  
mm

YATO	L (mm)	
YT-2450	180	6/24

YATO	L (mm)	
YT-2459	150	6/24



250  
mm



225  
mm

YATO	L (mm)	
YT-2451	250	6/24

YATO	L (mm)	
YT-2460	225	6/24



180  
mm

YATO	L (mm)	
YT-2452	180	6/24

GB Locking pliers  
D Klemmzange  
PL Szczypce zaciskowe  
RUS Клещи давящие  
CZ Kleště samosvorné  
H Patentfogó  
RO Clește de strângere

F Pince de serrage courte avec blocage  
I Pinze di bloccaggio  
E Pinzas de tornillo (de apriete)  
CN 大力钳



**250 mm**  
**0-42 mm**

YATO	L (mm)	
YT-2473	250	6/24



**250 mm**  
**0-42 mm**

YATO	L (mm)	
YT-2476	250	6/24

GB C-type welding locking pliers  
D Klemm- und Klammerzange vom Typ „C“  
PL Szczypce zaciskowe klamrowe typu „C“  
RUS Клещи давящие типа „C“  
CZ Kleště samosvorné upínací typu „C“  
H „C“ fogó

RO Clește de strângere cu clemă tip „C“  
F Pince de serrage type „C“  
I Pinze di bloccaggio tipo „C“  
E Pinzas de tornillo (de apriete) de grapa tipo „C“  
CN C型大力钳

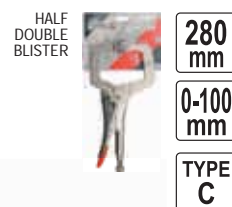

YATO	L (mm)	
YT-2466	280	6/24

YATO	L (mm)	
YT-2468	280	6/24

GB Chain locking pliers  
D Klemmzange mit Kette  
PL Szczypce zaciskowe z łańcuchem  
RUS Клещи давящие с цепью  
CZ Kleště samosvorné s řetězem  
H Láncos csőfogó  
RO Clește de strângere cu lanț  
F Pince de serrage avec une chaîne  
I Pinze di bloccaggio con la catena  
E Pinzas de tornillo (de apriete) con cadena  
CN 链条大力钳

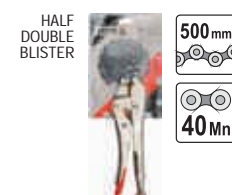

YATO		
YT-2469		6/24

GB Welding locking pliers  
D Klemmzange zum Schweißen  
PL Szczypce zaciskowe spawalnicze  
RUS Клещи давящие сварочные  
CZ Kleště samosvorné svářečské  
H Hegesztő fogó  
RO Clește de strângere pt. sudură  
F Pince de serrage pour soudeur  
I Pinze di bloccaggio per saldatura  
E Pinzas de tornillo (de apriete) para soldar  
CN 焊接用大力钳

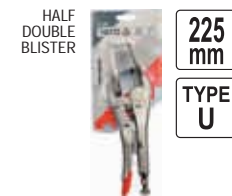

YATO	L (mm)	
YT-2461	225	6/24

GB Flat locking pliers  
D Klemmzange mit breiten Backen  
PL Szczypce zaciskowe o szerokich szczękach  
RUS Клещи давящие с широкими губками  
CZ Kleště samosvorné se širokými čelistmi  
H Lapos fogó  
RO Clește de strângere plat / patent  
F Pince de serrage large  
I Pinze con ganasce piane e palette  
E Pinzas de tornillo (de apriete) con mordazas anchas  
CN 铁皮大力钳

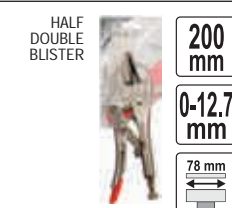

YATO	L (mm)	
YT-2463	200	6/24

- GB Self-locking multi grip pliers  
D Grip-Festhaltezange  
PL Szczypce blacharskie  
RUS Зажим ручной сварочный  
для закрепления лент и профилей  
CZ Kleště klempířské samodržící  
H Őnzáró rögzítőfogó  
RO Cleste autoblocant pt. tinichigerie  
F Pince pour tôle  
I Pinze per lamiera  
E Pinzas de chapa  
CN 多功能大力钳

SLIDING  
CARD



CrMo



200 mm 0-15 mm 70 mm TYPE W

<b>YATO</b>	L (mm)	
YT-2160	200	12/24



230 mm 0-15 mm 45 mm TYPE JJ

<b>YATO</b>	L (mm)	
YT-2161	230	12/24



215 mm 0-10 mm 45 mm TYPE LL

<b>YATO</b>	L (mm)	
YT-2162	215	12/36



210 mm 0-15 mm 25 mm TYPE J

<b>YATO</b>	L (mm)	
YT-2163	210	12/36

- GB Profile connection pliers  
D Zange zum Verbinden der Profile  
PL Szczypce do łączenia profili  
RUS Щипцы для соединения профилей  
CZ Kleště ke spojování profilů  
H Profilgyesítő fogó  
RO Cleste pt. îmbinarea profilelor  
F Pince pour sertir les profiles  
I Pinze per la unione profili  
E Pinzas para conectar perfiles  
CN 龙骨钳

SLIDING  
CARD



SECTION  
THICKNESS  
GRUBOSC  
PROFILU  
0,5-0,8 mm

275 mm

A380  
Al-Ti  
ALLOY  
(HEAD)

GR15  
BEARING  
STEEL  
(PUNCH)



<b>YATO</b>	L (mm)	
YT-5130	275	6/24

345 mm

65 Mn  
MATERIAL  
OF PUNCH  
PUNKTAK



<b>YATO</b>	L (mm)	
YT-5131	345	6/24

- GB Profile forming pliers  
D Zange zur Formgebung der Profile  
PL Szczypce do kształtowania profili  
RUS Щипцы для формировки профилей  
CZ Kleště k tvarování profilů  
H Profilformázó fogó  
RO Cleste pt. modelarea profilelor  
F Pince pour former les profiles  
I Pinze per la formazione di profili  
E Pinzas para formar perfiles  
CN 龙骨钳

SLIDING  
CARD



210 mm



80x35 mm  
JAWS  
SZCZEPKI

<b>YATO</b>	L (mm)	
YT-5140	210	2/12



80x35 mm  
JAWS  
SZCZEPKI

<b>YATO</b>	L (mm)	
YT-5141	210	2/12



150x35 mm  
JAWS  
SZCZEPKI

<b>YATO</b>	L (mm)	
YT-5142	210	2/12

GB Water pump pliers  
D Wasserpumpenzange  
PL Szczypce nastawne  
RUS Ключи переставные  
CZ Keleště siko  
H Vízpumpafágó

RO Cleste papagal  
F Pince réglable  
I Pinze regolabili  
E Alicates de fontanero ajustables  
CN 水泵钳

250 mm 300 mm CrV



YATO	L (mm)	
YT-2090	250	6/36
YT-2091	300	6/36

GB Water pump pliers  
D Wasserpumpenzange  
PL Szczypce nastawne  
RUS Ключи переставные  
CZ Keleště siko  
H Vízpumpafágó

RO Cleste papagal  
F Pince réglable  
I Pinze regolabili  
E Alicates de fontanero ajustables  
CN 水泵钳

250 mm CrV

JAW WIDTH SZEROKOSC SZCZEK 6 mm  
WORKING RANGE ADJUSTMENT REGULACJA ZAKRESU PRACY  
STRENGTHENED JAWS WZMOCNIENA KONSTRUKCJA



YATO	L (mm)	
YT-20911	250	10/50

GB Pipe wrench  
D Rohrschlüssel  
PL Klucz do rur  
RUS Ключ трубный

CZ Klíč součásti na trubky  
H Csőkulcs  
RO Cheie reglabila pt. tevi

F Clé aux tubes  
I Chiave per tubi  
E Llave para tubos  
CN 铝合金管钳

CrMo

HRC 55-60

Al HANDLE



YATO	i e / ro miar	max. pipe lameter / max. srednica rury	
YT-2482	14" (350 mm)	2" (50 mm)	6/12
YT-2483	18" (450 mm)	2.5" (63 mm)	2/10
YT-2484	24" (600 mm)	3" (75 mm)	2/6
YT-2485	36" (900 mm)	5" (125 mm)	3

GB Pipe wrench  
D Rohrschlüssel  
PL Klucz do rur

RUS Ключ трубный  
CZ Klíč součásti na trubky

H Csőkulcs  
RO Cheie reglabila pt. tevi  
F Clé serre-tube

I Chiave per tubi  
E Llave para tubos  
CN 铝合金管钳

HRC 55-60

OFFSET TYPE



GB Water pump pliers  
D Wasserpumpenzange  
PL Szczypce nastawne  
RUS Ключи переставные  
CZ Keleště siko  
H Vízpumpafágó

RO Cleste papagal  
F Pince réglable  
I Pinze regolabili  
E Alicates de fontanero ajustables  
CN 水泵钳

HALF DOUBLE BLISTER



250 mm

NICKEL IRON FINISH



YATO	L (mm)	
YT-2069	250	6/36



YATO	L (mm)	
YT-2070	250	6/24

GB Pipe wrench  
D Rohrschlüssel  
PL Klucz do rur  
RUS Ключ трубный

CZ Klíč součásti na trubky  
H Csőkulcs  
RO Cheie reglabila pt. tevi

F Clé aux tubes  
I Chiave per tubi  
E Llave para tubos  
CN 铝合金管钳

CrMo

HRC 55-60



YATO	i e / ro miar	max. pipe lameter / max. srednica rury	
YT-2488	10" (250 mm)	1" (25 mm)	6/18
YT-2489	12" (300 mm)	1.5" (38 mm)	6/12
YT-2490	14" (350 mm)	2" (50 mm)	2/10
YT-2491	18" (450 mm)	2.5" (63 mm)	3/6
YT-2492	24" (600 mm)	3" (75 mm)	2/4
YT-2493	36" (900 mm)	5" (125 mm)	1
YT-2494	48" (1200 mm)	6" (150 mm)	1

GB Pipe wrench  
D Rohrschlüssel  
PL Klucz do rur  
RUS Ключ трубный

CZ Klíč součásti na trubky  
H Csőkulcs  
RO Cheie reglabila pt. tevi

F Clé aux tubes  
I Chiave per tubi  
E Llave para tubos  
CN 铝合金管钳

HRC 55-60

Al HANDLE



YATO	i e / ro miar	max. pipe lameter / max. srednica rury	
YT-2222	12" (300 mm)	1" (25 mm)	6/24
YT-2223	14" (350 mm)	1.5" (38 mm)	4/16
YT-2224	18" (450 mm)	2" (50 mm)	3/12
YT-2225	24" (600 mm)	2.5" (63 mm)	3/6

GB Chain pipe wrench  
D Kettenrohrzange  
PL Klucz łańcuchowy do rur  
RUS Ключ цепной для труб  
CZ Klíč řetězový na trubky  
H Láncos csőfágó

RO Cheie reglabila pt. tevi cu lant  
F Clé à chaîne  
I Chiave a catena per tubi  
E Llave de cadena  
CN 链条管子钳

SLIDING CARD



4" 100 mm

300 mm

INDUCTION HARDENED TEETH ZĘBY HARTOWANE INDUKCYJNIE  
ADJUSTABLE WORKING RANGE REGULOWANY ZAKRES PRACY



YATO	L (mm)	max. pipe lameter / max. srednica rury	
YT-22260	300	4" (100 mm)	6/24

GB Tweezer  
D Pinzette  
PL Pęseta  
RUS Пинцет  
CZ Pinzeta  
H Csipesz  
RO Pensetă  
F Pince  
I Pinza  
E Pinzas  
CN 镊子

SLIDING  
CARD



302  
STAINLESS  
STEEL  
STAL  
NIEODŻEWNA  
ANTI  
MAGNETIC  
ANTYMAG-  
NETYCZNA  
ANTI ACID  
KWASO-  
ODPORNA



140  
mm HRC  
30

YATO	L (mm)	
YT-6903	140	20/480



115  
mm HRC  
30

YATO	L (mm)	
YT-6907	115	20/480



140  
mm HRC  
40

YATO	L (mm)	
YT-6916	140	20/480













Memo

# 7

## Electrician tools Narzędzia dla elektryków





<b>Insulated screwdrivers</b> <b>Wkrętaki izolowane</b> ..... 138 	<b>Electrical cutters</b> <b>Obcinaki elektryczne</b> ..... 146 
<b>Insulated slotted screwdrivers</b> Wkrętaki izolowane płaskie..... 138 <b>Insulated phillips screwdrivers</b> Wkrętaki izolowane krzyżakowe..... 138 <b>Insulated Pozidrive screwdrivers</b> Wkrętaki izolowane „Pozidrive”..... 138 <b>Insulated screwdriver sets</b> Komplet y wkręta ków izolowan ych..... 138	<b>Cable cutters</b> <b>Nożyce do kabli</b> ..... 146-147 
<b>Insulated pliers</b> <b>Szczypce izolowane</b> ..... 139 	<b>Electric meters &amp; voltage testers</b> <b>Mierniki elektryczne i próbniki napięcia</b> ..... 148 
<b>Combination pliers</b> Szczypce uniwersalne..... 139 <b>Side cutting pliers</b> Szczypce tnące, boczne..... 139 <b>Long nose pliers</b> Szczypce wydłużone, proste..... 139 <b>Bent nose pliers</b> Szczypce wydłużone, wygięte..... 139 <b>Wire stripping pliers</b> Szczypce do ściągania izolacji..... 139	<b>Multimeters</b> <b>Mierniki</b> ..... 149 
<b>Crimping pliers &amp; sets</b> <b>Szczypce do zaciskania konektorów i zestawy</b> ..... 140-142 	<b>Glue guns</b> <b>Pistolety do klejenia</b> ..... 150 
<b>Hydraulic pliers</b> <b>Ręczne praski hydrauliczne</b> ..... 143 	<b>Soldering tools &amp; accessories</b> <b>Lutownice i akcesoria</b> ..... 150-151 
<b>Wire strippers</b> <b>Ściągacze izolacji</b> ..... 143-145 	<b>Tweezers</b> <b>Pęsety</b> ..... 151 
	<b>Electrical insulation tapes &amp; sets</b> <b>Taśmy elektroizolacyjne i zestawy</b> ..... 152 

GB Insulated screwdriver  
D Isolierte Schraubendreher  
PL Wkrętki izolowane  
RUS Изолированная отвёртка  
CZ Izolovaný šroubovák  
H Szigetelt csavarhúzó

RO Şurubelniţă izolată  
F Tournevis isolé  
I Cacciavite isolato  
E Destornillador aislado  
CN 绝缘螺丝批

PLASTIC HANGER



1000 V

S2

HRC 56-60



- application: industry
- VDE certificate
- przeznaczenie: przemysł
- certyfikat VDE

YATO	⊖	L (mm)	☐
YT-2815	3.0	75	12/120
YT-2816	4.0	75	12/120
YT-2817	4.0	100	12/120

YATO	⊖	L (mm)	☐
YT-2818	5.5	125	12/120
YT-2819	6.5	150	12/120
YT-2820	8.0	175	12/120

7



- application: industry
- VDE certificate
- przeznaczenie: przemysł
- certyfikat VDE

YATO	⊕	L (mm)	☐
YT-2821	PH0	60	12/120
YT-2822	PH1	80	12/120

YATO	⊕	L (mm)	☐
YT-2823	PH2	100	12/120
YT-2824	PH3	150	12/120



- application: industry
- VDE certificate
- przeznaczenie: przemysł
- certyfikat VDE

YATO	⊕	L (mm)	☐
YT-2825	PZ1	80	12/120

YATO	⊕	L (mm)	☐
YT-2826	PZ2	100	12/120

GB Insulated screwdriver set  
D Isolierte Schraubendrehersatz  
PL Komplet wkrętek izolowanych  
RUS Изолированная отвёртка - набор  
CZ Izolované šroubováky  
H Szigetelt csavarhúzó

RO Şurubelniţă izolată  
F Set de tournevis isolés  
I Set di cacciavite isolato  
E Juego de destornilladores aislado  
CN 绝缘螺丝批组套

DOUBLE BLISTER



1000 V

S2

HRC 56-60



5 PCS



- application: industry
- VDE certificate
- przeznaczenie: przemysł
- certyfikat VDE

YATO	⊖	⊕	L (mm)	☐
YT-2827	3.0		75	20/40
	4.0		100	
	5.5		125	
		PH1	80	
		PH2	100	



7 PCS



- application: industry
- VDE certificate
- przeznaczenie: przemysł
- certyfikat VDE

YATO	⊖	⊕	⊕	L (mm)	☐
YT-2828	3.0			75	20/40
	4.0			100	
	5.5			125	
		PH1		80	
		PH2		100	
			PZ1	80	
			PZ2	100	

GB Combination pliers  
D Kombinationszange  
PL Szczypce uniwersalne  
RUS Плоскогубцы универсальные  
CZ Kleště kombinované  
H Kombinaltfogó  
RO Patent universal  
F Pince universelle  
I Pinze universali  
E Alicates universales  
CN 钢丝钳

160 mm 180 mm 200 mm 1000 V DIN 5746 CrV



05 VDE  
CERTIFICATE  
-IEC60900:2004

HALF  
DOUBLE  
BLISTER

YATO	L (mm)	
YT-2101	160	6/60
YT-2102	180	6/60
YT-2103	200	6/60

GB Diagonal side cutting pliers  
D Seitenschneider  
PL Szczypce tnące boczne  
RUS Бокорезы  
CZ Řezací kleště boční  
H Oldal csípőfogó  
RO Olește tăietor  
F Pince à coupe latérale  
I Pinze taglianti laterali  
E Alicates corte lateral  
CN 斜嘴钳

160 mm 1000 V DIN 5749 CrV



05 VDE  
CERTIFICATE  
-EN60900:2004

HALF  
DOUBLE  
BLISTER

YATO	L (mm)	
YT-2109	160	6/60

GB Diagonal side cutting pliers  
D Seitenschneider  
PL Szczypce tnące boczne  
RUS Бокорезы  
CZ Řezací kleště boční  
H Oldal csípőfogó  
RO Olește tăietor  
F Pince à coupe latérale  
I Pinze taglianti laterali  
E Alicates corte lateral  
CN 斜嘴钳

180 mm 1000 V DIN 5749 CrV



05 VDE  
CERTIFICATE  
-EN60900:2004

HALF  
DOUBLE  
BLISTER

YATO	L (mm)	
YT-2110	180	6/60

GB Long nose pliers  
D Radiozange  
PL Szczypce wydłużone proste  
RUS Тонкогубцы прямые  
CZ Prodloužené kleště rovné  
H Rádiófogó, egyenes  
RO Clește cu vârf ascuțit  
F Pince prolongée  
I Pinze lunghe diritte  
E Alicates de punta  
CN 尖嘴钳

160 mm 200 mm 1000 V DIN 5745 CrV



05 VDE  
CERTIFICATE  
-EN60900:2004

HALF  
DOUBLE  
BLISTER

YATO	L (mm)	
YT-2104	160	6/60
YT-2105	200	6/60

GB Bent nose pliers  
D Telefonzange  
PL Szczypce wydłużone wygięte  
RUS Тонкогубцы изогнутые  
CZ Prodloužené kleště ohnuté  
H Rádió - és telefonfogó, hajlítót  
RO Clește cu vârf ascuțit îndoit  
F Pince prolongée cambrée  
I Pinze a punte mezzo tonde  
E Alicates de punta curvos  
CN 弯嘴钳

200 mm 1000 V DIN 5745 CrV



05 VDE  
CERTIFICATE  
-EN60900:2004

HALF  
DOUBLE  
BLISTER

YATO	L (mm)	
YT-2107	200	6/60

GB Wire stripping pliers  
D Abisolierzange  
PL Szczypce do ściągania izolacji  
RUS Пасатижи для зачистки проводов  
CZ Kleště odizolovací na drát  
H Blankoló fogó  
RO Decablator  
F Pince à l'isolation  
I Pinze spelafili  
E Pinzas pelacables  
CN 剥线钳

160 mm 1000 V DIN 5745 CrV



05 VDE  
CERTIFICATE  
-EN60900:2004

HALF  
DOUBLE  
BLISTER

YATO	L (mm)	
YT-2112	160	6/60

- GB Quick interchangeable ratchet crimper set
- D Kabelschuhzange
- PL Zestaw do zaciskania konektorów
- RUS Инструмент для обжима и зачистки проводов
- CZ Kleště pro svěráni zaciskania konektorů
- H Krimpelő fogó
- RO Clește sertizat conectori
- F Pince à sertir pour connecteurs
- I Set pinze i compare a connettori
- E Pinzas de apretar de conectores
- CN 棘轮压线钳组套



6  
PCS

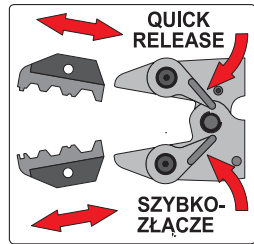

BMC & COLOR SLEEVE



YATO	mm <sup>2</sup>	A	mm <sup>2</sup>	A	mm <sup>2</sup>	A	mm <sup>2</sup>	A		
YT-2245	0.5-6.0	20-10	0.5-6.0	22-10	1.5-10.0	20-8	0.5-4.0	22-12	RG6, RG58, RG59, RG62	10

7

- GB Ratchet crimping pliers
- D Kabelschuhzange
- PL Szczypce do zaciskania konektorów
- RUS Инструмент для обжима и зачистки проводов

- CZ Kleště pro svěráni zaciskania konektorů
- H Krimpelő fogó
- RO Clește sertizat conectori
- F Pince pour serrer les connecteurs

- I Pinze i compare a connettori
- E Pinzas de apretar de conectores
- CN 棘轮压线钳

SLIDING CARD



YATO	mm <sup>2</sup>	A	
YT-2250	0.5-6.0	20-10	5/30

YATO	mm <sup>2</sup>	A	
YT-2300	0.5-6.0	20-10	5/30

- GB Ratchet crimping pliers
- D Kabelschuhzange
- PL Szczypce do zaciskania konektorów
- RUS Инструмент для обжима и зачистки проводов

- CZ Kleště pro svěráni zaciskania konektorů
- H Krimpelő fogó
- RO Clește sertizat conectori
- F Pince pour serrer les connecteurs

- I Pinze i compare a connettori
- E Pinzas de apretar de conectores
- CN 棘轮压线钳

BLISTER CARD



YATO	mm <sup>2</sup>	A	mm <sup>2</sup>	A	
YT-2255	0.08-2.0	28-14	0.12-0.3	26-22	10/60

YATO	mm <sup>2</sup>	A	mm <sup>2</sup>	A	mm <sup>2</sup>	A	
YT-2256	0.08-2.0	28-14	0.3-6.0	22-10	0.12-0.3	26-22	10/60

- GB Ratchet crimping pliers
- D Kabelschuhzange
- PL Szczypce do zaciskania konektorów
- RUS Инструмент для обжима и зачистки проводов

- CZ Kleště pro svěráni zaciskania konektorů
- H Krimpelő fogó
- RO Clește sertizat conectori
- F Pince pour serrer les connecteurs

- I Pinze i compare a connettori
- E Pinzas de apretar de conectores
- CN 棘轮压线钳

SLIDING CARD



YATO	mm <sup>2</sup>	A	
YT-2296	0.5-6.0	22-10	5/30



YATO	mm <sup>2</sup>	A	
YT-2246	0.5-6.0	22-10	5/30

GB Ratchet crimping pliers  
D Kabelschuhzange  
PL Szczypce do zaciskania konektorów  
RUS Инструмент для обжима  
и зачистки проводов



CZ Kleště pro svěrání zaciskania konektorů  
H Krimpelö fogó  
RO Clește sertizat conectori  
F Pince pour serrer les connecteurs

I Pinze i compare a conettori  
E Pinzas de apretar de conectores  
CN 棘轮压线钳





<b>YATO</b> 			
	mm <sup>2</sup>	A	
YT-2251	0.5-6.0	22-10	5/30





<b>YATO</b> 			
	mm <sup>2</sup>	A	
YT-2302	0.5-6.0	22-10	5/30



<b>YATO</b> 			
	mm <sup>2</sup>	A	
YT-2283	0.5-2.5	22-14	6/36





<b>YATO</b> 			
	mm <sup>2</sup>	A	
YT-2307	0.5-2.5	22-14	6/36



<b>YATO</b> 			
	mm <sup>2</sup>	A	
YT-2297	1.5-10.0	20-8	5/30



<b>YATO</b> 			
	mm <sup>2</sup>	A	
YT-2247	1.5-10.0	20-8	5/30



<b>YATO</b> 			
	mm <sup>2</sup>	A	
YT-2301	0.5-10.0	22-8	6/36



<b>YATO</b> 			
	mm <sup>2</sup>	A	
YT-2298	RG6, RG58, RG59, RG62		5/30



<b>YATO</b> 			
	mm <sup>2</sup>	A	
YT-2299	0.5-4.0	22-12	5/30



<b>YATO</b> 			
	mm <sup>2</sup>	A	
YT-2249	0.5-4.0	22-12	5/30

GB Ratchet crimping pliers  
D Kabelschuhzange  
PL Szczypce do zaciskania konektorów  
RUS Инструмент для обжима  
и зачистки проводов

CZ Kleště pro svěrání zaciskania konektorů  
H Krimpelő fogó  
RO Clește sertizat conectori  
F Pince pour serrer les connecteurs

I Pinze i compare a connettori  
E Pinzas de apretar de conectores  
CN 棘轮压线钳

SLIDING  
CARD



HRC  
44-47



<b>YATO</b> 	 mm²	
YT-2240	0.2-6.0	6/36

<b>YATO</b> 	 mm²	
YT-2305	0.2-6.0	6/36

GB Crimping pliers  
D Kabelschuhzange  
PL Szczypce do zaciskania konektorów  
RUS Инструмент для обжима  
и зачистки проводов  
CZ Kleště pro svěrání zaciskania konektorů

H Krimpelő fogó  
RO Clește sertizat conectori  
F Pince pour serrer les connecteurs  
I Pinze i compare a connettori  
E Pinzas de apretar de conectores  
CN 棘轮压线钳

SLIDING  
CARD



CAT.5

HRC  
42-48



<b>YATO</b> 		
YT-2242	RJ45	10/60



SK5

<b>YATO</b> 		
YT-2243	RJ45, RJ11	8/48



SK5

<b>YATO</b> 		
YT-22422	RJ45, RJ11, RJ12	10/60



SK5

<b>YATO</b> 		
YT-2244	RJ45, RJ11, RJ12, RJ22	10/60

- GB Hydraulic pliers  
D Manuelle Hydraulikpresse  
PL Ręczna praska hydrauliczna  
RUS Ручной гидравлический обжимной инструмент  
CZ Ruční hydraulický lis  
H Kézí hidraulikus prés  
RO Presă hidraulică manuală  
F Pince à sertir  
I Pressa idraulica manuale  
E Prensa hidráulica manual  
CN 液压钳



BMC & COLOR SLEEVE



YATO	crimping area / a uminium	range / ania mm <sup>2</sup> / copper / miedz	L (mm)	pressure / naci (T)	crimping jaws size / rozmiar szczęk zaciskających mm <sup>2</sup>	
YT-22860	10-95	10-120	415	8	10; 16; 25; 35; 50; 70; 95; 120	4
YT-22861	16-185	16-240	470	12	16; 25; 35; 50; 70; 95; 120; 150; 185; 240	3
YT-22862	16-240	16-300	470	18-20	16; 25; 35; 50; 70; 95; 120; 150; 185; 240; 300	3

- GB Crimping pliers  
D Kabelschuhzange  
PL Szczypce do zaciskania konektorów  
RUS Инструмент для обжима и зачистки проводов  
CZ Kleště pro svěření zaciskania konektorů  
H Krimpelő fogó  
RO Clește sertizat conectori  
F Pince pour serrer les connecteurs  
I Pinze i compare a conettori  
E Pinzas de apretar de conectores  
CN 棘轮压线钳

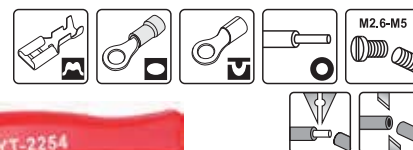

SLIDING CARD

YATO	mm <sup>2</sup>	A	mm <sup>2</sup>	A	mm <sup>2</sup>	A	mm <sup>2</sup>	A	
YT-2254	0.5-5.0	20-10	0.5-5.0	20-10	0.5-5.5	20-10	0.5-5.0	20-10	12/48

- GB Crimping pliers  
D Kabelschuhzange  
PL Szczypce do zaciskania konektorów  
RUS Инструмент для обжима и зачистки проводов  
CZ Kleště pro svěření zaciskania konektorů  
H Krimpelő fogó  
RO Clește sertizat conectori  
F Pince pour serrer les connecteurs

- I Pinze i compare a conettori  
E Pinzas de apretar de conectores  
CN 棘轮压线钳



SLIDING CARD



YATO	mm <sup>2</sup>	A	
YT-2271	0.5-6.0	22-10	20/120

- GB Wire stripper  
D Abisolierzange  
PL Ściągacz izolacji  
RUS Съёмник изоляции  
CZ Odizolovací klejtle  
H Blankolo fogo

- RO Decablator  
F Extracteur d'isolation  
I Pinze per scaricare isolamento  
E Extractor de aislado  
CN 万用剥线钳



SLIDING CARD



HRC 48-52

YATO	mm <sup>2</sup>	A	
YT-2266	0.25-1.3	30-16	10/60

YATO	mm <sup>2</sup>	A	
YT-2267	0.8-2.6	20-10	10/60

- GB Wire stripper  
D Abisolierzange  
PL Ściągacz izolacji  
RUS Съёмник изоляции  
CZ Odizolovací klejtle  
H Blankolo fogo  
RO Decablator  
F Extracteur d'isolation

- I Pinze per scaricare isolamento  
E Extractor de aislado  
CN 万用剥线钳



SLIDING CARD

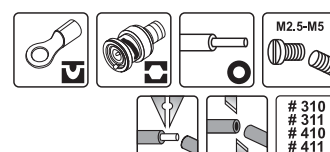

YATO	mm <sup>2</sup>	A	RG6	mm <sup>2</sup>	A	
YT-2277	0.5-6.0	22-10	RG6	0.5-6.0	20-8	10/60

GB Wire stripper  
 D Abisolierzange  
 PL Ściągacz izolacji  
 RUS Съёмник изоляции  
 CZ Odizolovací klejte

H Blankolo fogo  
 RO Decablator  
 F Extracteur d'isolation

I Pinze per scaricare isolamento  
 E Extractor de aislado  
 CN 万用剥线钳

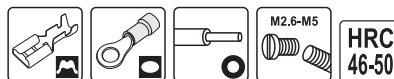
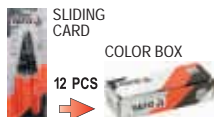
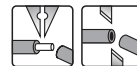

YATO	mm <sup>2</sup>	A		mm <sup>2</sup>	A	PCS packing	
YT-2292	0.5-6.0	22-10	RG6	0.64-2.6	22-10	12	72

YATO	mm <sup>2</sup>	A		mm <sup>2</sup>	A	PCS packing	
YT-22930	1.5-6.0	22-10		1.5-6.0	22-10	0.75-6.0	22-10 12/48

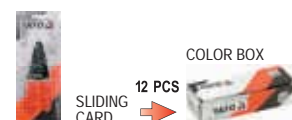
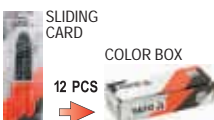
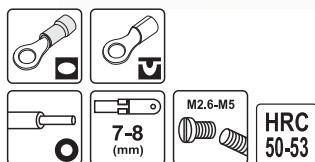

YATO	mm <sup>2</sup>	A		mm <sup>2</sup>	A	PCS packing	
YT-2293	1.25-2.5	8-12		1.0	8	12	72

YATO	mm <sup>2</sup>	A		mm <sup>2</sup>	A	PCS packing	
YT-2294	0.64-2.6	22-10				12	120

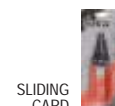
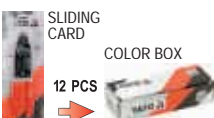
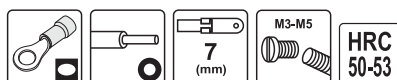

YATO	mm <sup>2</sup>	A		mm <sup>2</sup>	A	PCS packing	
YT-2295	0.5-6.0	22-10		0.8-2.6	20-10	12	72

YATO	mm <sup>2</sup>	A		mm <sup>2</sup>	A	PCS packing	
YT-2319	0.8-2.6	20-10				10/60	

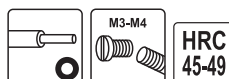
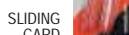

YATO	mm <sup>2</sup>	A		mm <sup>2</sup>	A	PCS packing	
YT-2272	0.34-6.0	22-10				20/120	

YATO	mm <sup>2</sup>	A		mm <sup>2</sup>	A	PCS packing	
YT-2273	0.8-2.6	20-10				10/60	

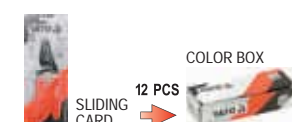
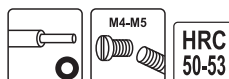

YATO	mm <sup>2</sup>	A		mm <sup>2</sup>	A	PCS packing	
YT-2290	0.64-2.6	22-10				12	120



- GB Universal wire stripper  
& ratchet crimping pliers  
D Multifunktion Abisolierzange  
& Kabelschuhklemmzange  
PL Uniwersalny ściągacz izolacji  
i szczypce do zaciskania konektorów  
RUS Инструмент для снятия изоляции и зажима проводов  
CZ Univerzální odizolovací klejtky  
& kleště pro svěrání  
zaciskání konektorů  
H Blankolo fogo & krimpelő fogó  
RO Decablator universal & clește sertizat conectori  
F Extracteur d'isolation multifonction  
I Pinze per scaricare isolamento  
E Extractor de aislado  
multifunción  
CN 万用剥线钳

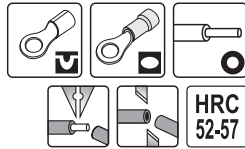

HRC  
52-57



7-8  
(mm)

HALF  
DOUBLE  
BLISTER



YATO	□		○		○		📦
	mm <sup>2</sup>	A	mm <sup>2</sup>	A	mm <sup>2</sup>	A	
YT-2270	0.5-6.0	22-10	1.5-6.0	22-10	0.2-6.0	24-10	5/30



SLIDING  
CARD



YATO	□		○		○		📦
	mm <sup>2</sup>	A	mm <sup>2</sup>	A	mm <sup>2</sup>	A	
YT-2313	0.5-6.0	22-10	1.5-6.0	22-10	0.2-6.0	24-10	5/30

- GB Universal wire stripper & ratchet crimping pliers  
D Multifunktion Abisolierzange & Kabelschuhklemmzange  
PL Uniwersalny ściągacz izolacji i szczypce  
do zaciskania konektorów  
RUS Инструмент для снятия изоляции и зажима проводов  
CZ Univerzální odizolovací klejtky  
& kleště pro svěrání zaciskání konektorů  
H Blankolo fogo & krimpelő fogó  
RO Decablator universal & clește sertizat conectori  
F Extracteur d'isolation multifonction  
I Pinze per scaricare isolamento  
E Extractor de aislado multifunción  
CN 剥线钳

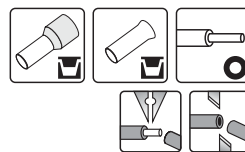

SLIDING  
CARD



YATO	□		○		📦
	mm <sup>2</sup>	A	mm <sup>2</sup>	A	
YT-2278	0.5-6.0	22-10	0.2-6.0	24-10	10/60

- GB Automatic wire stripper  
D Automatische Abisolierzange  
PL Automatyczny ściągacz izolacji  
RUS Клещи для удаления изоляции  
CZ Automatický stahovač izolace  
H Automatikus szigeteléselhúzó  
RO Clește automat pt. desizolat
- F Extracteur d'isolation  
automatique  
I Pinze per scaricare isolamento  
E Pelacables automatico  
CN 万用剥线钳

SLIDING  
CARD

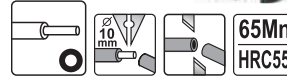

65Mn  
HRC55

YATO	📦
YT-2268	10/60

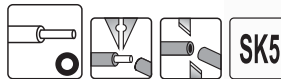

SK5

YATO	mm <sup>2</sup>	A	📦
YT-2275	0.5-6.0	20-10	10/60



SK5

YATO	mm <sup>2</sup>	A	📦
YT-2276	1.0-3.2	18-12	8/48



SK5

YATO	mm <sup>2</sup>	A	📦
YT-2316	1.0-3.2	18-12	8/48

- GB Wire stripper  
D Abisolierzange  
PL Ściągacz izolacji  
RUS Съёмник изоляции  
CZ Odizolovací klejtky  
H Blankolo fogo
- RO Decablator  
F Extracteur d'isolation  
I Pinze per scaricare  
isolamento  
E Extractor de aislado  
CN 万用剥线钳

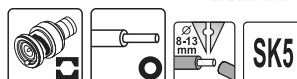

SK5

SLIDING  
CARD



YATO	□	○		📦
		mm <sup>2</sup>	A	
YT-2274	RG9, RG59	0.5-6.0	20-10	15/90

GB Electrical cutter  
D Seitenschneider  
PL Obcinak elektryczny  
RUS Инструмент для обрезки проводов  
CZ Elektrické upichováky  
H Kábelvágó  
RO Clește tăietor - electrician  
F Coupeur isolé

I Pinza per elettronica  
E Cortacables eléctricos  
CN 电子斜嘴钳

125 mm

SLIDING CARD



YATO	mm <sup>2</sup>	A	L (mm)	
YT-2260	0.5-1.5	20-18	125	15/150



YATO	L (mm)	
YT-2261	125	15/150

GB Electrical cutter  
D Seitenschneider  
PL Obcinak elektryczny  
RUS Инструмент для обрезки проводов  
CZ Elektrické upichováky  
H Kábelvágó  
RO Clește tăietor - electrician  
F Coupeur isolé

I Pinza per elettronica  
E Cortacables eléctricos  
CN 电子斜嘴钳

125 mm

3.0 (mm)

STAINLESS STEEL  
STAL  
NERDZEWA



SLIDING CARD



YATO	L (mm)	
YT-2262	125	20/120

GB Electrical cutter  
D Seitenschneider  
PL Obcinak elektryczny  
RUS Инструмент для обрезки проводов  
CZ Elektrické upichováky  
H Kábelvágó

RO Clește tăietor - electrician  
F Coupeur isolé  
I Pinza per elettronica  
E Cortacables eléctricos  
CN 电子斜嘴钳

130 mm



HRC 55-57

65 Mn

SLIDING CARD



YATO	L (mm)	
YT-2263	130	12/120

GB Cable cutter  
D Kabelschere  
PL Szczypce do cięcia przewodów  
RUS Кабелерезы  
CZ Elektrické upichováky  
H Kábelvágó  
RO Patent tăietor pt. electrice

F Pince pour câbles  
I Cesoia per cavi elettrici  
E Tijeras para cables  
CN 电缆断线钳

170 mm

3.5 mm

10.5 (mm)

SK5

SLIDING CARD



YATO	L (mm)	
YT-2279	170	10/60

GB Cable stripper  
D Kabelmesser  
PL Nożyk do kabli  
RUS Нож кабельный

CZ Nůž na kabele  
H Kábelkés  
RO Cuțitaș pt. cabluri  
F Couteau aux câbles

I Coltellino per cavi  
E Cuchillo  
CN 电缆剥线钳

8-28 mm



SLIDING CARD



YATO	Ø (mm)	
YT-2280	8-28	10/100

GB Electrician scissors  
D Elektrische Schere  
PL Nożyczki dla elektryków  
RUS Ножницы универсальные  
CZ Elektrické nůžky  
H Univerzális olló  
RO Foarfece - electrician

F Ciseaux pour electriciens  
I Forbici per elettricisti  
E Tijeras eléctricos  
CN 电工剪

140 mm

STAINLESS STEEL  
STAL  
NERDZEWA

HRC 5-5



SLIDING CARD



YATO	L (mm)	
YT-1974	140	12/120

GB Electrician's knife  
D Montagemesser  
PL Nóż składany monterski  
RUS Нож складной

CZ Montážní nůž  
H Szerelőkécs  
RO Cuțit pt. decablat  
F Couteau d'électricien

I Coltello  
E Cuchillo de montaje  
CN 电工刀

SLIDING CARD



3CR13

HRC 42-48

85 mm

200 mm



YATO	L (mm)	
YT-7600	200	6/96

75 mm

190 mm



YATO	L (mm)	
YT-7601	190	6/96

GB Cable cutter  
D Kabelschere  
PL Szczypce do cięcia przewodów  
RUS Кабелерезы  
CZ Elektrické upichováky  
H Kábelvágó  
RO Patent tăietor pt. electricie  
F Pince à couper les fils  
I Pinze per tagliare i cavi  
E Tijeras para cables  
CN 电缆剪

SLIDING  
CARD



- application: for copper and aluminium electric cables
- przeznaczenie: do cięcia miedzianych i aluminiowych kabli

YATO	L (mm)	max. Ø (mm)	
YT-1966	160	6	6/60
YT-1967	210	7	6/60
YT-1968	240	8	6/48

GB Heavy duty cable cutter  
D Schwere Drahtschere  
PL Wzmocnione nożyce do cięcia przewodów  
RUS Кабелерезы  
CZ Elektrické upichováky  
H Kábelvágó  
RO Patent tăietor pt. electricie  
F Pince renforcée à couper les fils  
I Pinze per tagliare i cavi  
E Tijeras para cables  
CN 电缆剪

SLIDING  
CARD



- application: for copper and aluminium electric cables
- przeznaczenie: do cięcia miedzianych i aluminiowych kabli

YATO	L (mm)	max. Ø (mm)	
YT-1969	240	9	6/48

GB Heavy duty cable cutter  
D Schwere Drahtschere  
PL Wzmocnione nożyce do cięcia przewodów  
RUS Кабелерезы  
CZ Elektrické upichováky  
H Kábelvágó  
RO Patent tăietor pt. electricie  
F Pince renforcée à couper les fils  
I Pinze per tagliare i cavi  
E Tijeras para cables  
CN 电缆剪

SLIDING  
CARD

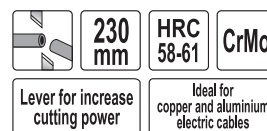

YATO	L (mm)	max. Ø (mm)	
YT-1933	230	9	6/36

GB Cable cutter  
D Kabelschere  
PL Nożyce do kabli  
RUS Кабелерезы  
CZ Elektrické upichováky  
H Kábelvágó  
RO Patent tăietor pt. electricie  
F Cisailles à câbles  
I Cesiole per cavi  
E Tijeras para cables  
CN 电缆剪



COLOR BOX



STEEL  
STAL

GB Ratchet cable cutter  
D Ratschenkabelschneider  
PL Nożyce zapadkowe do kabli  
RUS Кабелерез секторный  
CZ Kleště na kabely, rohatka se západkou  
H Racsnis kábelvágó  
RO Cleste pt. taiat cablu cu clichet  
F Cisailles à câbles  
I Cricchetto taglia cavo  
E Cortacables de carraca  
CN 棘轮电缆剪

COLOR BOX



Cu/Al  
CABLE  
KABEL

60Si2Mn

HRC 50  
CUTTING BLADE  
OSTRZE TNAČE



YATO	cutting range / max. przekrój cięcia mm <sup>2</sup>	L (mm)	
YT-18600	240	300	10



YATO	cutting range / max. przekrój cięcia mm <sup>2</sup>	L (mm)	
YT-18602	380	380	10

YATO	cutting range / max. przekrój cięcia mm <sup>2</sup>	L (mm)	
YT-18610	125	370	20
YT-18611	250	580	10
YT-18612	500	770	5

GB Voltage tester  
 D Spannungsprüfer  
 PL Próbnik napięcia  
 RUS Отвёртка с передачей  
 CZ Zkoušeč napětí

H Fáziskereső  
 RO Creion de tensiune  
 F Testeur de tension  
 type tournevis

I Cerca fase  
 E Comprobador de corriente  
 CN VDE 测电笔

PLASTIC HANGER



<b>YATO</b>	⊖	L (mm)	
YT-2830	4	190	12/144

GB Digital voltage tester  
 D Spannungsprüfer  
 PL Uniwersalny tester elektryczny  
 RUS Отвёртка с передачей  
 CZ Zkoušeč napětí

H Fáziskereső  
 RO Creion de tensiune  
 F Testeur de tension  
 type tournevis

I Cerca fase  
 E Comprobador de corriente  
 CN 多功能测电笔

SLIDING CARD



1.5-9 V 	50-500 Hz	CONTINUITY TEST TEST CIĄGŁOŚCI	70-250 V 	70-600 V 	POWER ZASILANE 2x1.5 V LR41 BATTERY* * BATTERY NOT INCLUDED *BATERII NIE DOŁĄCZONO



<b>YATO</b>	
YT-2864	6/120

7

GB Digital voltage tester  
 D Spannungsprüfer  
 PL Uniwersalny tester elektryczny  
 RUS Отвёртка с передачей  
 CZ Zkoušeč napětí

H Fáziskereső  
 RO Creion de tensiune  
 F Testeur de tension  
 type tournevis

I Cerca fase digitale  
 E Comprobador de corriente  
 CN 测电笔

SLIDING CARD



1.5-9 V 	50-500 Hz	70-250 V 	70-1000 V 	POWER ZASILANE 2x1.5 V LR44 BATTERY* * BATTERY NOT INCLUDED *BATERII NIE DOŁĄCZONO

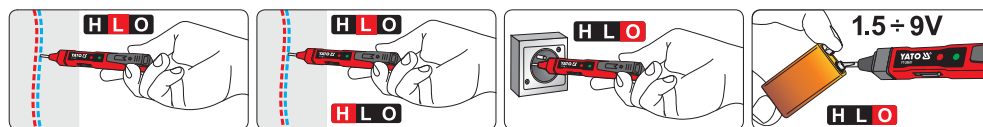

<b>YATO</b>	
YT-28631	6/120

GB Digital voltage tester  
 D Digitaler-Spannungsprüfer  
 PL Wskaźnik elektryczny  
 RUS Тестер напряжения цифровой  
 CZ Zkoušečka napětí digitální  
 H Digitális voltmérő

RO Tester digital pt. tensiune electrica  
 F Testeur de tension  
 type tournevis

I Cerca fase digitale  
 E Indicador eléctrico  
 CN 数显测电笔

SLIDING CARD



12-250 V 	50-500 Hz	CONTINUITY TEST TEST CIĄGŁOŚCI	LCD DISPLAY	NO BATTERY NEEDED NIE POTRZEBUJE BATERII
--------------	-----------	-----------------------------------	-------------	---



<b>YATO</b>	
YT-2861	20/500



<b>YATO</b>	
YT-2862	20/500



<b>YATO</b>	
YT-2863	6/120

GB Digital universal multimeter  
D Universell digital Messgerät  
PL Cyfrowy miernik uniwersalny  
RUS Универсальный цифровой измеритель  
CZ Digitální multimetr univerzální  
H Digitális multiméter  
RO Multimetru digital universal  
F Multimètre numérique  
I Universale tester digitale  
E Manómetro digital universal  
CN 数字万用表

U 0-500 ~V	U 0-500 ~V	I 0-5 ~A
R 0-2 MΩ		h <sub>FE</sub> PNP NPN



COLOR BOX

**YATO**  
YT-73080 50

	U 0-600 ~V	U 0-600 ~V	I 0-10 ~A	I 0-10 ~A	R 0-40 MΩ
C 0-100 μF	f 100 kHz		T -20°+ +1000°C		AUTO RANGE AUTO ZAKRES
				AUTO POWER OFF	



NYLON CASE & COLOR BOX

**YATO**  
YT-73086 24

U 0-1000 ~V	U 0-750 ~V	I 0-10 ~A	I 0-10 ~A	R 0-20 MΩ	C 0-20 μF
			h <sub>FE</sub> PNP NPN	AUTO POWER OFF	



COLOR BOX

**YATO**  
YT-73082 30

5 in 1 5 w 1	U 0-600 ~V	U 0-600 ~V	I 0-10 ~A	I 0-10 ~A	R 0-40 MΩ
C 0-100 μF	f 200 kHz		T -20°+ +1000°C		%RH 30%+ 90%
			AUTO RANGE AUTO ZAKRES	AUTO POWER OFF	



NYLON CASE & COLOR BOX

**YATO**  
YT-73087 24

U 0-600 ~V	U 0-600 ~V	I 0-10 ~A	I 0-10 ~A	R 0-20 MΩ	C 0-1000 μF
T -20°+ +1000°C		h <sub>FE</sub> PNP NPN	AUTO RANGE AUTO ZAKRES	AUTO POWER OFF	



COLOR BOX

**YATO**  
YT-73084 44

TRUE RMS	U 0-600 ~V	U 0-600 ~V	I 0-10 ~A	I 0-10 ~A	R 0-60 MΩ
C 0-4000 μF	f 9.999 MHz		T -20°+ +1000°C		AUTO RANGE AUTO ZAKRES
				AUTO POWER OFF	



COLOR BOX

**YATO**  
YT-73088 20

U 0-600 ~V	U 0-600 ~V	I 0-600 ~A	R 0-200 MΩ
T -20°+ +1000°C		AUTO RANGE AUTO ZAKRES	AUTO POWER OFF



NYLON CASE & COLOR BOX

**YATO**  
YT-73091 20

- GB Electric glue gun
- D Heissklebepistole
- PL Pistolet do klejenia
- RUS Пистолет для клея
- CZ Pistole na lepení
- H Ragasztópisztoly
- RO Pistol pt. lipit
- F Pistolet à colle
- I Pistola colla
- E Pistola de cola
- CN 热胶枪

230V~ 50Hz	35 (400) W	11 mm	
---------------	------------------	-------	---

- GB Cordless glue gun
- D Heissklebepistole
- PL Akumulatorowy pistolet do klejenia
- RUS Пистолет для клея
- CZ Pistole na lepení

- H Ragasztópisztoly
- RO Pistol pt. lipit
- F Pistolet à colle
- I Pistola colla con batteria
- E Pistola de cola
- CN 热胶枪

7.4 V 2.6 Ah Li-Ion		8W	11 mm
---------------------------	---	----	-------



COLOR BOX



DOUBLE BLISTER

<b>YATO</b>	
YT-82401	35 (400) 12/24

<b>YATO</b>	
YT-82421	8 6/24

- GB Soldering station
- D Lötstation
- PL Stacja lutownicza
- RUS Паяльная станция
- CZ Letovací stanice
- H Forrasztópáka állomás
- RO Stație de lipit
- F Station de soudage
- I Stazione digitale di saldatura
- E Estación de soldadura
- CN 数显焊台

230V~ 50Hz	48W	150-450 °C	7.1 mm 65 mm	LCD DISPLAY
---------------	-----	---------------	-----------------	----------------

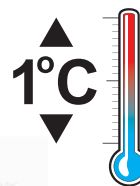

COLOR BOX

<b>YATO</b>	
YT-82455	48 4

GB Soldering iron  
D LötKolben  
PL Lutownica oporowa  
RUS Электропаяльник

CZ Pájka odporová  
H Forrasztópáka  
RO Ciocan de lipit  
F Fer à souder

I Saldatore a stagno  
E Soldador de resistencia  
CN 电烙铁

230V~  
50Hz



HANGING  
DISPLAY  
COLOR BOX



YATO	working temp. soldering tip (°C)	length (mm)	width (mm)	height (mm)
YT-8271	30	400	ø3.8 x 70	16
YT-8272	60	500	ø6.0 x 78	16
YT-8273	80	520	ø6.8 x 64	16

GB Transformer soldering gun  
D Lötpestole  
PL Lutownica transformatorowa  
RUS Паяльник электрический  
CZ Transformátorová ráječka  
H Forrasztópáka  
RO Aparat de lipit letcon  
cu transformator

F Fer à souder  
I Saldatore istantaneo  
E Soldador transformador  
CN 电烙铁

230V~  
50Hz

180  
W

LED



BMC  
& COLOR  
SLEEVE



YATO	Power (W)	Quantity
YT-8245	180	10

GB Tweezer  
D Pinzette  
PL Pęseta  
RUS Пинцет

CZ Pinzeta  
H Csipesz  
RO Pensetă  
F Pince

I Pinza  
E Pinzas  
CN 镊子

SLIDING  
CARD



302  
STAINLESS  
STEEL  
STAL  
NIERDZEWNIA

ANTI  
MAGNETIC  
ANTYMAG-  
NETYCZNA

ANTI ACID  
KWASO-  
ODPORNA



140  
mm

HRC  
30

YATO	L (mm)	Quantity
YT-6903	140	20/480



115  
mm

HRC  
30

YATO	L (mm)	Quantity
YT-6907	115	20/480



140  
mm

HRC  
40

YATO	L (mm)	Quantity
YT-6916	140	20/480



GB Insulation tape  
D Isolierband  
PL Taśma elektroizolacyjna  
RUS Изолянта



CZ Izolační páska  
H Szigetelőszalag  
RO Banda izolatoare  
F Ruban électrique

I Nastro isolante  
E Cinta aislante  
CN 绝缘胶带

EN60454-3-1-1/F-PVC/60/R-Tp  
DIELECTRIC STRENGTH / WYTRZYMAŁOŚĆ DIELEKTRYCZNA > 35 Kv / mm  
ELONGATION / WYDŁUŻENIE > 125%  
FLAME TEST / TEST OGNIOWY < 1 s  
STORE TEMPERATURE / TEMPERATURA SKŁADOWANIA +10°C ~ +40°C  
USING TEMPERATURE / TEMPERATURA UŻYTKOWANIA +5°C ~ +50°C







YATO 	imen ion / wymiary	
YT-8152	12 mm x 10 m x 0.13 mm	96/384
YT-8159	15 mm x 20 m x 0.13 mm	72/288
YT-8165	19 mm x 20 m x 0.13 mm	72/288
YT-8174	25 mm x 20 m x 0.19 mm	48/192
YT-8177	50 mm x 33 m x 0.19 mm	48

YATO 	imen ion / wymiary	
YT-81592	15 mm x 20 m x 0.13 mm	72/288
YT-8166	19 mm x 20 m x 0.13 mm	72/288



7





YATO 	imen ion / wymiary	
YT-81591	15 mm x 20 m x 0.13 mm	72/288
YT-81651	19 mm x 20 m x 0.13 mm	72/288

YATO 	imen ion / wymiary	
YT-81594	15 mm x 20 m x 0.13 mm	72/288
YT-81654	19 mm x 20 m x 0.13 mm	72/288





YATO 	imen ion / wymiary	
YT-81593	15 mm x 20 m x 0.13 mm	72/288
YT-81655	19 mm x 20 m x 0.13 mm	72/288



YATO 	imen ion / wymiary	
YT-81595	15 mm x 20 m x 0.13 mm	72/288
YT-81652	19 mm x 20 m x 0.13 mm	72/288



10  
PCS

10  
PCS

YATO 	imen ion / wymiary	
YT-8156	12 mm x 10 m x 0.13 mm	10/40

YATO 	imen ion / wymiary	
YT-8173	19 mm x 20 m x 0.13 mm	6/24



Memo

# 8

**Hammers, chisels,  
punches & axes**  
**Młotki, dłuta,  
przecinaki i siekiery**



Machinist hammers  
Młotki ślusarskie

156



Dead blow hammers  
Młotki bezodrzutowe

158



Stoning hammers  
Młotki kamieniarskie

156



Ball pein hammers & sets  
Młotki blacharskie i zestawy

158-159



Hammers with tubular steel handle  
Młotki z trzonkiem rurowym

157



Chisels, cold chisels & punches  
Dłuta, przecinaki i przebijaki

160-162



Claw hammers

Młotki szewskie..... 157

Roofing hammers

Młotki ciesielskie..... 157

Mason's hammers

Młotki murarskie..... 157

Plasterer's hatchets

Toporki tynkarskie..... 157

Wood chisels & sets

Dłuta stolarskie i zestawy..... 160

Cold chisels

Przecinaki..... 160

Punches

Przebijaki..... 160

Pin punches

Wybijaki..... 161

Punches

Punktaki..... 161

Cold chisel & punch sets

Zestawy przecinaków i punktaków..... 161

Fully drop forged hammers  
Młotki monolityczne kute

157



Wrecking bars

Łomy

163



Claw hammers

Młotki szewskie..... 157

Roofing hammers

Młotki ciesielskie..... 157

Mason's hammers

Młotki murarskie..... 157

Axes

Siekiery

163



Rubber mallets  
Młotki gumowe

158



GB Machinist hammer CZ Zámečnické kladívko I Martello da aggiustatore  
 D Schlosserhammer H Vaskalapács E Martillo  
 PL Miotek ślusarski RO Ciocan de lăcătușerie F 钳工锤  
 RUS Молоток слесарный F Marteau serrurier

DIN  
1041

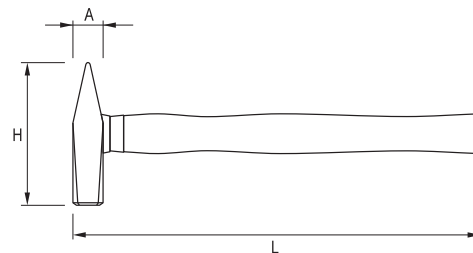

YATO	m (g)	L (mm)	A (mm)	H (mm)	
YT-4491	100	260	15	80	12/120
YT-4492	200	280	20	93	6/60
YT-4493	300	300	21	103	6/60
YT-4494	400	310	23	111	6/48
YT-4495	500	320	26	118	6/36

YATO	m (g)	L (mm)	A (mm)	H (mm)	
YT-4496	600	330	28	119	6/36
YT-4497	800	350	31	125	6/24
YT-4498	1000	360	35	132	6/24
YT-4499	1500	380	40	143	6/12
YT-4500	2000	400	45	153	6/12

8

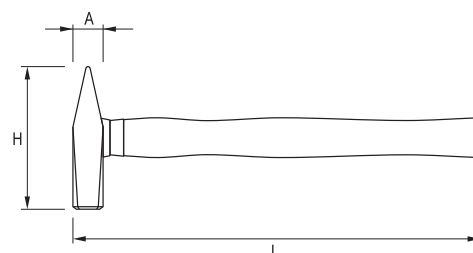

YATO	m (g)	L (mm)	A (mm)	H (mm)	
YT-4501	100	260	15	82	12/120
YT-4502	200	280	19	95	6/60
YT-4503	300	300	23	105	6/60
YT-4504	400	310	25	112	6/48
YT-4505	500	320	27	118	6/36

YATO	m (g)	L (mm)	A (mm)	H (mm)	
YT-4506	600	330	29	122	6/36
YT-4507	800	350	33	135	6/24
YT-4508	1000	360	36	135	6/24
YT-4509	1500	380	42	145	6/12
YT-4510	2000	400	47	155	6/12

GB Safety stoning hammer H Kőtörő kalapács I Martello da aggiustatore  
 D Fäustel RO Ciocan pt. zidarie E Martillo  
 PL Miotek kamieniarski F Marteau de tailleur de pierres CN 石工锤  
 RUS Молоток каменщика  
 CZ Palička kovová

DIN  
6475

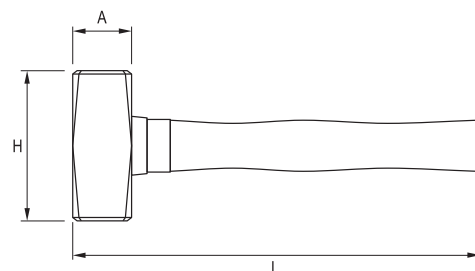

YATO	m (g)	L (mm)	A (mm)	H (mm)	
YT-4550	1000	260	40	95	6/24
YT-4551	1250	260	43	100	6/24

YATO	m (g)	L (mm)	A (mm)	H (mm)	
YT-4552	1500	280	45	110	6/12
YT-4553	2000	300	50	120	6/12

GB Claw hammer  
D Schusterhammer  
PL Młotek szewski  
RUS Молоток гвоздодёр  
CZ Ševcovské kladívko  
H Cipész kalapács

RO Ciocan de cizmărie  
F Marteau de cordonnier  
I Martello calzolaio  
E Martillo sacador  
CN 羊角锤



- high quality steel handle
- forged carbon steel head hardened and tempered
- stalowa rączka
- główka ze stali węglowej, kuta, ulepszona cieplnie

YATO	m (g)	L (mm)	A (mm)	H (mm)	
YT-4560	450	318	30	130	6/24

GB Mason's hammer, type B  
D Berliner Mauerhammer  
PL Młotek murarski berliński  
RUS Молоток каменщика широкий

F Marteau de maçon  
I Martello muratore tipo Berlin  
E Martillo de albanil de Berlín  
CN B型泥工锤



- high quality steel handle
- forged carbon steel head hardened and tempered
- stalowa rączka
- główka ze stali węglowej, kuta, ulepszona cieplnie

YATO	m (g)	L (mm)	A (mm)	H (mm)	
YT-4562	600	315	24x23	200	6/24

GB Plasterer's hatchet  
D Gipserbeil  
PL Toporek tynkarski  
RUS Топор штукатурный  
CZ Omitáči sekyrka  
H Kőműves szekerce  
RO Toporaș de tencuit  
F Hachette de plâtrier  
I Martello con accetta  
E Hacha enlucido  
CN 多用斧



- high quality steel handle
- forged carbon steel head hardened and tempered
- stalowa rączka
- główka ze stali węglowej, kuta, ulepszona cieplnie

YATO	m (g)	L (mm)	A (mm)	H (mm)	
YT-4564	600	315	25x20	175	6/24

GB Roofing hammer  
D Latthammer Geschmiedet  
PL Młotek ciesielski  
RUS Молоток желязячкіца  
CZ Tesařské kladívko  
H Ácskalapács  
RO Ciocan de dulgherie

F Marteau de charpentier  
I Martello calzolaio  
E Martillo techumbre  
CN 连体独角锤



- high quality steel handle
- forged carbon steel head hardened and tempered
- stalowa rączka
- główka ze stali węglowej, kuta, ulepszona cieplnie

YATO	m (g)	L (mm)	A (mm)	H (mm)	
YT-4571	600	331	25x25	165	6/24

GB Roofing hammer  
D Latthammer Geschmiedet  
PL Młotek ciesielski  
RUS Молоток желязячкіца  
CZ Tesařské kladívko

H Ácskalapács  
RO Ciocan de dulgherie  
F Marteau de charpentier  
I Martello per carpentiere  
E Martillo techumbre  
CN 独角锤



- high quality steel handle
- forged carbon steel head hardened and tempered
- stalowa rączka
- główka ze stali węglowej, kuta, ulepszona cieplnie

YATO	m (g)	L (mm)	A (mm)	H (mm)	
YT-4561	600	318	25x25	165	6/24

GB Mason's hammer, type R  
D Mauerhammer Rheinische Form  
PL Młotek murarski reński  
RUS Молоток каменщика узкий  
CZ Zednické kladívko renské  
H Kőműves kalapács, rajnai típus

RO Ciocan de zidărie (tip ren)  
F Marteau de maçon  
I Martello muratore tipo rin  
E Martillo de albañil de Rin  
CN R型泥工锤



- high quality steel handle
- forged carbon steel head hardened and tempered
- stalowa rączka
- główka ze stali węglowej, kuta, ulepszona cieplnie

YATO	m (g)	L (mm)	A (mm)	H (mm)	
YT-4563	600	315	23x23	170	6/24

GB Claw hammer  
D Schusterhammer  
PL Młotek szewski  
RUS Молоток гвоздодёр  
CZ Ševcovské kladívko  
H Cipész kalapács  
RO Ciocan de cizmărie  
F Marteau de cordonnier  
I Martello calzolaio  
E Martillo sacador  
CN 连体羊角锤



- high quality steel handle
- forged carbon steel head hardened and tempered
- stalowa rączka
- główka ze stali węglowej, kuta, ulepszona cieplnie

YATO	m (g)	L (mm)	A (mm)	H (mm)	
YT-4570	450	315	30	130	6/24

GB Mason's hammer, type R  
D Mauerhammer Rheinische Form  
PL Młotek murarski reński  
RUS Молоток каменщика узкий  
CZ Zednické kladívko renské  
H Kőműves kalapács, rajnai típus

RO Ciocan de zidărie (tip ren)  
F Marteau de maçon  
I Martello muratore tipo rin  
E Martillo de albañil de Rin  
CN 连体R型泥工锤



- high quality steel handle
- forged carbon steel head hardened and tempered
- stalowa rączka
- główka ze stali węglowej, kuta, ulepszona cieplnie

YATO	m (g)	L (mm)	A (mm)	H (mm)	
YT-4573	600	382	25x24	158	6/24

- GB Rubber mallet with fibreglass, TPR handle  
 D Gummihammer mit Fiberglasstiel  
 PL Młotek gumowy z trzonkiem z włókna szklanego  
 RUS Киянка резиновая со стеклопластиковой ручкой  
 CZ Pryžové kladívko  
 H Gumikalapács
- RO Ciocan de cauciuc  
 F Maillet caoutchouc  
 I Martello mazzuola in gomma  
 E Mazo de goma  
 CN 纤维柄橡胶锤



YATO	m (g)	L (mm)	Ø (mm)	H (mm)	
YT-4594	440	340	50	87.5	6/36

- GB Dead blow mallet  
 D Rückschlagsfreier Schonhammer  
 PL Młotek bezodrzutowy  
 RUS Молоток безинерционный  
 CZ Palička nárazová plněná celogumová  
 H Visszarúgás mentes gumikalapács  
 RO Ciocan cu absorbție  
 F Maillet sans recul  
 I Martello morto colpo  
 E Martillo sin reacción  
 CN 防震无回弹橡胶锤

**PU**

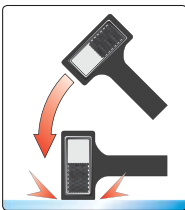

YATO	m (g)	L (mm)	Ø (mm)	H (mm)	
YT-4620	740	300	44.5	100.0	4/24
YT-4622	900	336	53.5	100.0	4/24
YT-4623	1300	350	59.0	118.5	3/12

- GB PU & nylon heads mallet  
 D Schonhammer mit PU & Nylon-Schlagkopf  
 PL Młotek blacharski  
 RUS Молоток рихтовочный  
 CZ Palička klempířská  
 H Vaskalapács  
 RO Ciocan tinichigerie cap PU / nylon  
 F Marteau spécial en PU/nylon  
 I Martello per lamiera  
 E Martillo chapista  
 CN 木柄安装锤



**PU** **NYLON**

- GB Rubber mallet with wooden handle  
 D Gummihammer mit Holzstiel  
 PL Młotek gumowy z drewnianym trzonkiem  
 RUS Молоток резиновый  
 CZ Pryžové kladívko  
 H Gumikalapács
- RO Ciocan de cauciuc  
 F Maillet caoutchouc  
 I Martello mazzuola in gomma  
 E Mazo de goma  
 CN 木柄橡胶锤



YATO	m (g)	L (mm)	Ø (mm)	H (mm)	
YT-4600	230	259	44	71.0	12/48
YT-4601	340	291	49	79.5	12/48
YT-4602	370	300	50	87.5	6/36
YT-4603	580	341	58	96.0	6/36
YT-4604	780	341	63	117.0	6/36
YT-4605	980	345	72	122.0	6/24

- GB Dead blow mallet  
 D Rückschlagsfreier Schonhammer  
 PL Młotek bezodrzutowy  
 RUS Молоток безинерционный  
 CZ Palička nárazová plněná celogumová  
 H Visszarúgás mentes gumikalapács
- RO Ciocan cu absorbție  
 F Maillet sans recul  
 I Martello morto colpo  
 E Martillo sin reacción  
 CN 尼龙安装锤

**PU**



YATO	m (g)	L (mm)	Ø (mm)	H (mm)	
YT-4624	265	318	30.0	94	10/40
YT-4625	430	350	40.0	100	6/36
YT-4626	490	348	45.0	110	6/36

- GB PU head for mallet  
 D Polyurethan Schlagkopf  
 PL Końcówka PU do młotka  
 RUS Наконечник молотка из полиуретана  
 CZ Náhradní koncovka k paličce PU  
 H PU kalapácsfej cserélhető  
 RO Cap PU pt. ciocan tinichigerie  
 F Tête PU pour marteau  
 I Bocca PU di ricambio  
 E Cabeza PU para martillo chapista  
 CN PU软头

**PU**

**SOFT**  
**MIĘKKA**



YATO	Ø (mm)	or / a	
YT-4635	22	YT-4630	6/60
YT-4636	28	YT-4631	6/60
YT-4637	35	YT-4632	6/60
YT-4638	45	YT-4633	6/60
YT-4639	60	YT-4634	6/60

- GB Nylon head for mallet  
 D Nylon Schlagkopf  
 PL Końcówka nylonowa do młotka  
 RUS Наконечник молотка из твердого нейлона  
 CZ Náhradní koncovka k paličce nylon  
 H Műanyag kalapácsfej cserélhető  
 RO Cap nylon pt. ciocan tinichigerie  
 F Tête nylon pour marteau  
 I Bocca di ricambio, nylon  
 E Cabeza de nylon para martillo chapista  
 CN 尼龙硬头

**NYLON**

**HARD**  
**TWARDA**



YATO	Ø (mm)	or / a	
YT-4640	22	YT-4630	6/60
YT-4641	28	YT-4631	6/60
YT-4642	35	YT-4632	6/60
YT-4643	45	YT-4633	6/60
YT-4644	60	YT-4634	6/60

GB Auto body fender set  
D Karosserie-Ausbeulsatz  
PL Komplet młotków blacharskich  
RUS Молотки рихтовочные  
CZ Souprava klempířských kladívek  
H Bádogos kalapács készlet

RO Set de ciocane de tablă  
F Set pour carrossier  
I Martello per lamiera  
E Juego de mazos de hojalatero  
CN 钣金工具组套

7  
PCS

DROP  
FORGED  
KUTE

GENUINE  
HICKORY



BMC  
& COLOR  
SLEEVE

YATO	m (g)	
YT-4590	4900	4

GB Ball pein hammer  
D Ausbeulhammer  
PL Młotek blacharski  
RUS Молоток рихтовочный  
CZ Klempířské kladívko  
H Bádogos kalapács

RO Ciocan pt. tabla  
F Marteau à panne ronde  
I Martello per lamiera  
E Martillo de hojalatero  
CN 圆头锤

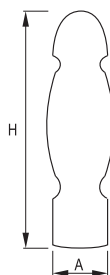

YATO	m (g)	L (mm)	A (mm)	H (mm)	
YT-4515	225	280	26	80	6/36
YT-4516	450	315	34	100	6/24
YT-4518	900	380	40	125	6/12

GB Ball pein hammer  
D Ausbeulhammer  
PL Młotek blacharski  
RUS Молоток рихтовочный  
CZ Klempířské kladívko  
H Bádogos kalapács

RO Ciocan pt. tabla  
F Marteau à panne ronde  
I Martello per lamiera  
E Martillo de hojalatero  
CN 圆头锤

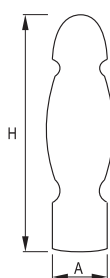

YATO	m (g)	L (mm)	A (mm)	H (mm)	
YT-4519	225	295	26	80	6/36
YT-4520	450	335	35	100	6/24
YT-4521	680	360	36	115	6/12
YT-4522	900	380	40	125	6/12

GB Wood chisel  
D Stechbeitel  
PL Dłuto stolarskie  
RUS Долото  
CZ Rezbářské dláto  
H Asztalos véső

RO Daltă de tâmplărie  
F Ciseau  
I Scalpello  
per falegname  
E Cíncel para madera  
CN 木工凿

DOUBLE BLISTER

**CrV 60**  
**HRC 56-62**



YATO	i e / ro miar (mm)	
YT-6241	8	10/60
YT-6242	10	10/60
YT-6243	12	10/60
YT-6244	14	10/60
YT-6245	15	10/60
YT-6246	16	10/60
YT-6247	18	10/60

YATO	i e / ro miar (mm)	
YT-6248	20	10/60
YT-6249	22	10/60
YT-6251	25	10/60
YT-6253	28	10/60
YT-6256	35	10/60
YT-6258	38	10/60

GB Chisel set  
D Meißelsatz  
PL Zestaw dłut  
RUS Набор зубил

CZ Sada dlát  
H Hidegvágó készlet  
RO Set de dălți  
F Set de ciseaux à bois

I Set scalpelli  
E Juego de cinceles  
CN 木工凿组套

**4 PCS**  
**10 16 20 25 mm**  
**CrV 60**  
**HRC 58-60**



DOUBLE BLISTER

**YATO**  
YT-6260 **5/20**

GB Chisel set  
D Meißelsatz  
PL Zestaw dłut  
RUS Набор зубил

CZ Sada dlát  
H Hidegvágó készlet  
RO Set de dălți  
F Set de ciseaux à bois

I Set scalpelli  
E Juego de cinceles  
CN 木工凿组套

**3 PCS**  
**CrV**  
**16 25 32 mm**



PLASTIC HANGER

**YATO**  
YT-6280 **10/30**

**4 PCS**  
**CrV**  
**10 12 16 20 mm**



PLASTIC HANGER

**YATO**  
YT-6281 **6/24**

GB Cold chisel with protection  
D Schlitzmeißel mit Handschutz  
PL Przecinak z osłoną  
RUS Зубило с протектором  
CZ Plochý sekáč (z krytem)  
H Hidegvágó, lapos (védőfejjel)

RO Daltă - tăietor  
plată (cu apărătoare)  
F Burin  
I Scalpello con protezione  
E Cíncel plano (con protector)  
CN 石工凿

**25x300 mm**  
**CrV**



PLASTIC HANGER

**YATO**  
YT-4700 **L (mm)** **4/24**  
300

GB Cold chisel with protection  
D Schlitzmeißel mit Handschutz  
PL Przecinak z osłoną  
RUS Зубило с протектором  
CZ Plochý sekáč (z krytem)  
H Hidegvágó, lapos (védőfejjel)  
RO Daltă - tăietor plată (cu apărătoare)

F Burin  
I Scalpello con protezione  
E Cíncel plano (con protector)  
CN 石工凿

**76x267 mm**  
**CrV**



PLASTIC HANGER

**YATO**  
YT-4701 **L (mm)** **4/24**  
267

GB Punch with protection  
D Spitzmeißel mit Handschutz  
PL Przebijak z osłoną  
RUS Скарпель с пластмассовой ручкой  
CZ Zednický průbojník (z krytem)  
H Falvéső (védőfejjel)  
RO Dorn (perforator) pt. perete (cu apărătoare)  
F Perçoir  
I Scalpello a punta con protezione  
E Cíncel de cerrajería con protector  
CN 水泥尖凿

**300 mm**  
**CrV**



PLASTIC HANGER

**YATO**  
YT-4705 **L (mm)** **4/24**  
300

GB Chisel and punch set  
D Trennmeißel- und Durchtreiber-Satz  
PL Zestaw przecinaków i punktaków  
RUS Зубила и пробойники с протектором  
CZ Sekáče a průbojníky  
H Véső és lyukasztó készlet

RO Set dalti de impact  
F Kit de burins et perçoirs  
I Scalpelli e bulino  
E Juego de cinceles de acero templado y punzones  
CN 冲凿组套

**6 PCS**  
**CHISEL 12x180 mm 16x180 mm 19x180 mm**  
**PUNCH 3x180 mm 3x180 mm 4x180 mm**  
**CrV**



PLASTIC HANGER

**YATO**  
YT-4710 **L (mm)** **10/20**  
180



- GB Cold chisel  
D Flachmeißel  
PL Przecinak płaski  
RUS Зубило плоское  
CZ Sekáč plochý  
H Laposvágó
- RO Dalta lata  
F Burin  
I Scalpello a punta  
E Tajadera en frío  
CN 凿子



CrV  
6150



SLIDING  
CARD

YATO	L (mm)	chisel width / szerokość dłuta (mm)	
YT-47147	142	10.0	20/120
YT-47148	152	12.5	20/120
YT-47149	172	16.0	20/120

- GB Taper punch  
D Durchtreiber  
PL Dobijak stożkowy  
RUS Пробойник конусный  
CZ Průbojník  
H Lyukasztó
- RO Dorn conic  
F Percuteur  
I Scalpello a punta  
E Retacador de cono  
CN 冲子

150  
mm



CrV  
6150



SLIDING  
CARD

YATO	L (mm)	pin diameter / średnica grotu (mm)	
YT-47141	150	1.5	20/120
YT-47142	150	3.0	20/120
YT-47143	150	4.0	20/120
YT-47144	150	5.0	20/120
YT-47145	150	6.0	20/120
YT-47146	150	8.0	20/120

- GB Taper punch  
D Durchtreiber  
PL Dobijak stożkowy  
RUS Пробойник конусный  
CZ Průbojník  
H Lyukasztó  
RO Dorn conic
- F Matoir  
I Scalpello a punta  
E Retacador de cono  
CN 冲子

SLIDING  
CARD



140  
mm



CrV  
6150



YATO	L (mm)	center punch / średnica punktaka (mm)	
YT-47152	140	2.0	20/120

- GB Center punch  
D Kömer  
PL Punktak  
RUS Пробойник - керн  
CZ Důlčik  
H Pontozó  
RO Punctator
- F Pointeau  
I Punzoni  
E Retacador - punzón centrador  
CN 冲子

SLIDING  
CARD



CrV  
6150



YATO	L (mm)	taper point en / średnica stożka (mm)	
YT-47150	100	6.0	20/120
YT-47151	112	8.0	20/120

- GB Pin punch set  
D Splintentreiber Satz  
PL Zestaw wybijaków  
RUS Пробойник булавочный- набор  
CZ Sada vyrážečů  
H Csapszegkiütő készlet
- RO Set de dornuri  
F Set de perceuteurs  
I Set scalpelli  
E Juego de punzones  
CN 销式冲子组套

SLIDING  
CARD



6  
PCS

150  
mm



Pin diameter:  
1.5, 3.0, 4.0,  
5.0, 6.0,  
8.0 mm

CrV  
6150



YATO	L (mm)	
YT-47121	150	6/24

- GB Chisel set  
D Flachmeißelsatz  
PL Zestaw przecinaków  
RUS Зубила в наборе  
CZ Sekáče  
H Hidegvágó
- RO Set dalti zidarie  
F Set de burins  
I Set scalpelli  
E Cinceles  
CN 冲凿组套

PLASTIC  
HANGER



3  
PCS

CHISEL  
10x142 mm  
12x152 mm  
16x172 mm

CrV



YATO		
YT-4711		6/24

- GB Chisel and punch set  
D Trennmeißel- und Durchtreiber-Satz  
PL Zestaw przecinaków i punktaków  
RUS Зубила, керны и пробойники в наборе  
CZ Sekáče a průbojníky  
H Véső és lyukasztó készlet  
RO Set dalti de impact  
F Set de burins et pointeaux  
I Set scalpelli  
E Juego de cinceles de acero templado y punzones  
CN 冲凿组套

PLASTIC  
HANGER



6  
PCS

CHISEL  
10x142  
12x152  
mm

PUNCH  
2x140 mm  
3x152 mm  
6x152 mm  
8x115 mm

CrV



YATO		
YT-4712		6/24

GB Mini cold chisel and punch set  
 D Trennmeissel- und Durchtreiber-Satz  
 PL Zestaw wybijaków i przecinak  
 RUS Зубила и керны в наборе  
 CZ Sekáče a průbojníky  
 H Véső és lyukasztó készlet  
 RO Set dalti de impact  
 F Set de burins et perceurs mini  
 I Set scalpelli e bulini  
 E Juego de cinceles de acero templado y punzones  
 CN 迷你冲凿组套

PLASTIC HANGER



3 PCS 125 mm  
 CrV COLD CHISEL: 10 mm  
 PIN PUNCH: 3 mm SOLID PUNCH: 3 mm



**YATO** YT-4713 10/60

GB Chisel and punch set  
 D Trennmeissel- und Durchtreiber-Satz  
 PL Zestaw przecinaków i punktaków  
 RUS Зубила, керны и пробойники в наборе  
 CZ Sekáče a průbojníky  
 H Véső és lyukasztó készlet  
 RO Set dalti de impact  
 F Set de burins et pointeaux  
 I Set scalpelli  
 E Juego de cinceles de acero templado y punzones  
 CN 冲凿组套

PLASTIC HANGER



12 PCS CrV SOLID PUNCH: 4 mm CENTER PUNCH: 90 DEGR. 6 mm 8 mm  
 PIN PUNCH: 1.5 mm 3 mm 4 mm 5 mm 6 mm 8 mm  
 COLD CHISEL: 10 mm 13 mm 16 mm



**YATO** YT-4714 10/20

GB Pin punch  
 D Splintentreiber  
 PL Wybijak  
 RUS Пробойник булавочный  
 CZ Vyrážeč  
 H Csapszegkiütő

RO Dorn cilindric  
 F Percuteur  
 I Punzoni  
 E Punzón expulsador  
 CN 销式冲子

SLIDING CARD



150 mm CrV 60 PIN DIAMETER: Ø 3.8 mm



**YATO** YT-4690 L (mm) 150 20/120

GB Taper punch  
 D Durchtreiber  
 PL Dobijak stożkowy  
 RUS Пробойник конусный  
 CZ Průbojník  
 H Lyukasztó  
 RO Dorn conic

F Mator  
 I Punzoni  
 E Retacador de cono  
 CN 冲孔器

SLIDING CARD



120 mm CrV 60 CENTER PUNCH: Ø 3.3 mm



**YATO** YT-4691 L (mm) 120 20/120

GB Center punch  
 D Körner  
 PL Dobijak punktak  
 RUS Пробойник - керн  
 CZ Důlčák  
 H Pontozó

RO Punctator  
 F Pointeau  
 I Punzoni  
 E Retacador - punzón centrador  
 CN 冲子

SLIDING CARD



120 mm CrV 60 TAPER POINT END



**YATO** YT-4692 L (mm) 120 20/120

GB Cold chisel  
 D Flach Meissel  
 PL Przecinak płaski  
 RUS Зубило плоское  
 CZ Sekáč plochý  
 H Laposvágó

RO Dalta lata  
 F Burin plat  
 I Scalpello piatto  
 E Tajadera en frío  
 CN 扁铲

SLIDING CARD



130 mm CrV 60 CHISEL WIDTH: 12 mm



**YATO** YT-4693 L (mm) 130 20/120

GB Cape chisel  
 D Kreuzmeissel  
 PL Przecinak prostokątny  
 RUS Зубило „лика”  
 CZ Sekáč křížový  
 H Keresztvágó  
 RO Dalta ascutita

F Burin  
 I Scalpello rettangolare  
 E Tajadera rectangular  
 CN 钎头

SLIDING CARD



130 mm CrV 60 CHISEL WIDTH: 5.5 mm



**YATO** YT-4694 L (mm) 130 20/120

GB Chisel and punch set  
 D Trennmeissel- und Durchtreiber-Satz  
 PL Zestaw przecinaków i punktaków  
 RUS Зубила и керны в наборе  
 CZ Sekáče a průbojníky  
 H Véső és lyukasztó készlet  
 RO Set dalti de impact  
 F Set de burins  
 I Set scalpelli e bulino  
 E Juego de cinceles de acero templado y punzones  
 CN 样冲组套

SLIDING CARD



5 PCS CrV 60 PIN PUNCH: Ø 3.8 mm TAPER PUNCH: Ø 3.3 mm  
 TAPER POINT END COLD CHISEL: 12 mm  
 CAPE CHISEL: 5.5 mm



**YATO** YT-4695 6/24

GB Hexagonal wrecking bar  
D Brechstange  
PL Łom sześciokątny  
RUS Лом-гвоздодёр шестигранный  
CZ Šestiúhlé páčidlo  
H Hatszögű feszítővas  
RO Ranga pt. scos cuie  
F Pied-de-biche manche hexagonal  
I Mazza di ferro  
E Palanqueta  
CN 撬棒

**DROP FORGED KUTE**

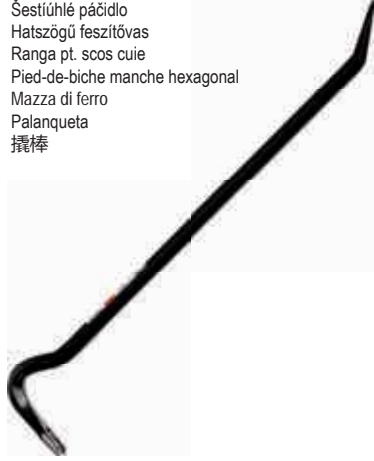

YATO	i e / ro miar (mm)	
YT-46800	400x18	6/12
YT-46801	450x18	6/12
YT-46802	600x18	6/12
YT-46803	750x18	6/12
YT-46804	900x18	5/10

GB Profiled wrecking bar  
D Nageleisen  
PL Łom profilowany  
RUS Лом-гвоздодёр  
CZ Páčidlo  
H Szögkihúzó  
RO Ranga pt. scos cuie  
F Pied-de-biche profilé  
I Mazza di ferro  
E Palanqueta  
CN 撬棒

**DROP FORGED KUTE**



YATO	i e / ro miar (mm)	
YT-46810	350x22x13	6/12
YT-46811	450x30x17	6/12
YT-46812	600x30x17	4/8
YT-46813	750x30x17	4/8
YT-46814	900x30x17	3/6

GB Flat wrecking bar  
D Nageleisen spitze  
PL Łom płaski  
RUS Лом плоский  
CZ Páčidlo ploché  
H Lapos feszítővas  
RO Ranga plata  
F Pied-de-biche plat  
I Mazza di ferro  
E Palanqueta  
CN 撬棒

**DROP FORGED KUTE**



YATO	i e / ro miar (mm)	
YT-46820	300x35x6	10/30
YT-46821	380x35x6	10/20
YT-46822	450x35x6	10/20
YT-46823	600x35x6	10/20

GB Go-through pry bar set  
D Nageleisensatz  
PL Zestaw łomów  
RUS Набор ломов  
CZ Sada mini páčidel  
H Szögkihúzó készlet  
RO Set leviere  
F Set de pieds-de-biche  
I Set mazza di ferro  
E Juego de palancas de hierro  
CN 穿心撬棒组套

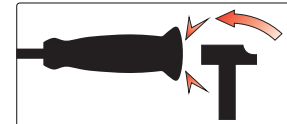

**4 PCS**

- 198x6x6 mm, 110 g
- 304x10x10 mm, 292 g
- 456x10x10 mm, 479 g
- 608x12x12 mm, 745 g

DOUBLE BLISTER

YATO		
YT-4730		3/6

GB Axe  
D Beil Hicorystiel  
PL Siekiera  
RUS Топор  
CZ Sekerka  
H Szekecse  
RO Secure  
F Hache  
I Ascia  
E Hacha  
CN 把斧

**DIN 5131 7294** GENUINE HICKORY



YATO	m (g)	L (mm)	D N	
YT-8001	600	360	5131	24
YT-8002	800	380	5131	20
YT-8003	1000	430	5131	12
YT-8004	1250	710	7294	12
YT-8005	1400	710	7294	12
YT-8006	1600	810	7294	12

GB Axe  
D Beil Hicorystiel  
PL Siekiera  
RUS Топор  
CZ Sekerka  
H Szekecse  
RO Secure  
F Hache  
I Ascia  
E Hacha  
CN 把斧

GENUINE HICKORY

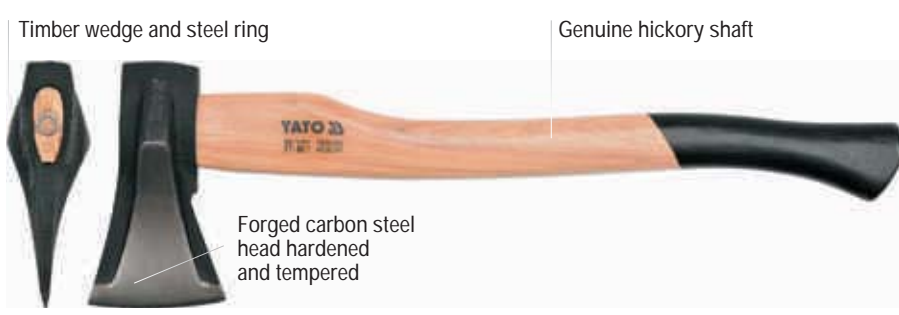

YATO	m (g)	L (mm)	
YT-8011	1000	515	6
YT-8012	2000	820	6

# 9

## Clamps, vices & holders Ściski, imadła i wsporniki



Clamps  
Ściski



166

Magnetic holders  
Wsporniki magnetyczne



168

Vices  
Imadła



167

- GB F-clamp
- D Schraubzwinge
- PL Ścisk stolarski
- RUS Струбцина
- CZ Truhlářské upínadlo
- H Asztalos szorító
- RO Menghină pt. tâmplărie
- F Presse à serrage pour menuisier
- I Morsetto da falegname
- E Tornillo de apriete
- CN F夹钳



**QUICK ADJUSTMENT SZYBKA REGULACJA**



**QUICK ADJUSTMENT SZYBKA REGULACJA**

YATO	L (mm)	
YT-6401	160x80	10/30
YT-6402	200x80	10/30
YT-6403	250x80	10/30
YT-6404	300x80	10/30
YT-6405	450x80	10/20

YATO	L (mm)	
YT-6406	600x80	10/20
YT-6407	400x120	10
YT-6408	500x120	10
YT-6409	600x120	10
YT-6410	900x120	5

YATO	L (mm)	
YT-6412	300x120	10
YT-6413	400x120	10
YT-6414	500x120	5
YT-6415	600x120	5
YT-6416	900x120	5
YT-6417	1050x120	5



YATO	L (mm)	
YT-6440	100x50	12/60
YT-6441	150x50	12/48
YT-6442	200x50	12/48
YT-6443	250x50	12/48
YT-6444	300x50	12/48
YT-6445	200x80	10/20
YT-6446	250x80	10/20
YT-6447	300x80	10/20

YATO	L (mm)	
YT-6448	500x80	10/20
YT-6449	300x120	10
YT-6450	500x120	10
YT-6451	800x120	6
YT-6452	1000x120	6
YT-6453	1200x120	6
YT-6454	1500x120	6

- GB Quick release clamp
- D Schnellklemme
- PL Ścisk szybkozaciskowy
- RUS Быстрозажимная струбцина
- CZ Svěrka rychloupínací
- H Gyors asztalos szorító
- RO Clemă cu prindere rapidă

- F Presse à serrage rapide pour menuisier
- I Morsetto rapido
- E Apretador rápido
- CN 快速夹



**QUICK ADJUSTMENT SZYBKA REGULACJA**

YATO	L (mm)	max. expan range / max. zasięg ro pierania (mm)	max. c.amping range / max. zasięg sciskania (mm)	max. jaws depth / max. głębokość szczęk (mm)	
YT-64280	200	247-515	0-203	92	6/18
YT-64281	300	247-616	0-304	92	6/12
YT-64282	450	247-769	0-457	92	6/12
YT-64283	600	247-921	0-609	92	6/12
YT-64284	750	247-1074	0-762	92	4/8

YATO	L (mm)	max. expan range / max. zasięg ro pierania (mm)	max. c.amping range / max. zasięg sciskania (mm)	max. jaws depth / max. głębokość szczęk (mm)	
YT-64290	200	206-456	0-203	85	6/18
YT-64291	300	206-557	0-304	85	6/18
YT-64292	450	206-710	0-457	85	6/12
YT-64293	600	206-862	0-609	85	6/12
YT-64294	750	206-1015	0-762	85	6/12
YT-64295	900	206-1167	0-914	85	6/12

- GB Spring clamp
- D Federklemme
- PL Ścisk sprężynowy
- RUS Струбцина
- CZ Pružinové upínadlo
- H Rugós szorító
- RO Cleste presa pt. lemn
- F Pince de serrage
- I Morsetto a molla
- E Pinza
- CN 弹簧夹



YATO	L (mm)	max. aw range / max. zasięg szczęk (mm)	max. jaws depth / max. głębokość szczęk (mm)	
YT-64270	100	42	44	24/240
YT-64271	150	55	68	12/120
YT-64272	200	79	91	10/100

- GB C-Clamp
- D C-Schraubzwinge
- PL Ścisk typu „C”
- RUS Струбцина типа „С”
- CZ Svěrka tvaru „C”
- H Pillanatszorító
- RO Menghină tip „C”
- F Serre-joint
- I Morsetto tipo „C”
- E Tornillo tipo „C”
- CN 深喉型C型夹



**DROP FORGED KUTE**

YATO	i e / ro miar (mm)	force pressure / sila naci u (kg)	
YT-6420	50	1500	6/30
YT-6421	75	1950	6/18
YT-6422	100	2980	6/12
YT-6423	150	3200	6/12
YT-6424	200	3600	6

GB Swivel base bench vice  
D Drehbare Schraubstock  
PL Imadło ślusarskie obrotowe  
RUS Тиски слесарные поворотные  
CZ Zámečnický svěrák otáčivě  
H Satu, lakatos forgó  
RO Menghină rotativă  
F Étau rotatif de serrurier  
I Morsa a cerniera  
E Tornillo de apriete giratorio  
CN 台虎钳

COLOR BOX



- anvil and changeable jaws made of hardened steel
- kowadełko i wymienne szczęki z hartowanej stali

	<b>7 kg</b>	<b>YATO</b>	weight (kg) waga (kg)	
		YT-6501	7	2
	<b>10 kg</b>	<b>YATO</b>	weight (kg) waga (kg)	
		YT-6502	10	2
	<b>15 kg</b>	<b>YATO</b>	weight (kg) waga (kg)	
		YT-6503	15	1
	<b>19 kg</b>	<b>YATO</b>	weight (kg) waga (kg)	
		YT-65048	19	1
	<b>21 kg</b>	<b>YATO</b>	weight (kg) waga (kg)	
		YT-6504	21	1
	<b>29.5 kg</b>	<b>YATO</b>	weight (kg) waga (kg)	
		YT-65049	29.5	1

GB Hinged pipe vice  
D Rohrschraubstock  
PL Imadło zaciskowe do rur  
RUS Тиски для труб  
CZ Uprínací svěrák na trubky  
H Satu, csőszorító  
RO Menghină pt. țevi  
F Étau de serrage à tuyaux  
I Morsa stringi tubo  
E Tornillo de apriete para tubos  
CN 管子台虎钳



**S55C**

COLOR BOX



<b>YATO</b>	Ø (mm)	
YT-6510	60	4
YT-6511	76	2
YT-6512	90	2
YT-6513	110	1

GB Swivel base bench vice  
D Drehbare Schraubstock  
PL Imadło ślusarskie obrotowe  
RUS Тиски слесарные поворотные  
CZ Zámečnický svěrák otáčivě  
H Satu, lakatos forgó  
RO Menghină rotativă  
F Étau rotatif de serrurier  
I Morsa a cerniera  
E Tornillo de apriete giratorio  
CN 台虎钳

COLOR BOX



- anvil and changeable jaws made of hardened steel
- kowadełko i wymienne szczęki z hartowanej stali

				<b>HRC 45-52</b> JAWISZCZĘKI	<b>10 kg</b>	<b>YATO</b>	weight (kg) waga (kg)	
						YT-6505	10	1
				<b>HRC 45-52</b> JAWISZCZĘKI	<b>20 kg</b>	<b>YATO</b>	weight (kg) waga (kg)	
						YT-6506	20	1

GB Adjustable angle welding magnet  
 D Verstellbarer Magnet-Werkstückhalter  
 PL Wspornik magnetyczny spawalniczy regulowany  
 RUS Регулируемый магнит заварки угла  
 CZ Pohovovací magnetický držák ke svařování  
 H Állítható, mágneses, hegesztő támasz  
 RO Dispozitiv magnetic reglabil pt. sudura  
 F Support magnétique de soudure  
 I Supporto della saldatura magnetico  
 E Soporte magnético de soldadura, ajustable  
 CN 焊接磁铁



DOUBLE BLISTER

YATO	⤴ (kg)	mm	
YT-0862	2x22.5	85x65x22	6

GB Magnetic welding holder  
 D Magnet-Werkstückhalter  
 PL Kątownik magnetyczny spawalniczy  
 RUS Магнитная струцина заварки

CZ Magnetický uhelník ke svařování  
 H Mágneses, hegesztő szögvas  
 RO Dispozitiv magnetic fixare pt. sudura  
 F Support magnétique de soudure

I Angolo magnetico da saldatura  
 E Escuadra magnética de soldadura  
 CN 焊接磁铁

DOUBLE BLISTER



YATO	⤴ (kg)	mm	
YT-0863	11.5	82x120x13	6/48



YATO	⤴ (kg)	∅ (mm)	mm	
YT-0864	22.5	18	102x155x17	6/30
YT-0865	34.0	46	122x190x25	6/18

GB Magnetic welding holder  
 D Magnet-Werkstückhalter  
 PL Kątownik magnetyczny spawalniczy z wyłącznikiem  
 RUS Магнитная струцина заварки с выключателем

CZ Magnetický uhelník ke svařování s vypínačem  
 H Mágneses, hegesztő szögvas, kapcsolóval  
 RO Dispozitiv magnetic fixare pt. sudura cu intreruptor  
 F Support magnétique de soudure

I Triangolo magnetico da saldatura con interruttore  
 E Escuadra magnética de soldadura con interruptor  
 CN 焊接磁铁

DOUBLE BLISTER

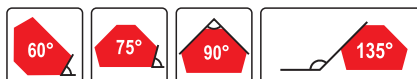

YATO	⤴ (kg)	mm	
YT-0866	11.5	64x95x14	6/24
YT-0867	34.0	111x136x24	6/18

GB Magnetic welding holder with switch  
 D Magnet-Werkstückhalter mit Schalter  
 PL Kątownik magnetyczny spawalniczy z wyłącznikiem  
 RUS Магнитный держатель заварки с выключателем

CZ Magnetický uhelník ke svařování s vypínačem  
 H Mágneses, hegesztő szögvas, kapcsolóval  
 RO Dispozitiv magnetic fixare pt. sudura cu intreruptor  
 F Support magnétique de soudure

I Triangolo magnetico da saldatura con interruttore  
 E Escuadra magnética de soldadura, con interruptor  
 CN 焊接磁铁

DOUBLE BLISTER



YATO	⤴ (kg)	mm	
YT-0870	13.5	107x160x26	6/24



Memo

# 10

## Cutting tools Narzędzia tnące

**YATO** 

item number:  
YT-6068

GB TCT circular saw blade for cutting of wood

D Hartmetallbestückt

Kreissägeblatt

für schneiden von Holz

PL Pila tarczowa do drewna

z węglikiem wolframu

RUS Пила дисковая по дереву

(твердый сплав)

RO Ferăstrău circular

cu dinți din wolfram pt. Lemn

210x30x3.2x2.2H

60T



10000 obr/min

**YATO** 

item number:  
YT-6068

GB TCT circular saw blade for cutting of wood

D Hartmetallbestückt

Kreissägeblatt

für schneiden von Holz

PL Pila tarczowa do drewna

z węglikiem wolframu

RUS Пила дисковая по дереву

(твердый сплав)

RO Ferăstrău circular

cu dinți din wolfram pt. Lemn

210x30x3.2x2.2HW

60T



$n_{max}$  8 000 obr/min



**Drills**  
Wiertła

173-178



Twist drill bits HSS & sets	
Wiertła do metalu HSS i zestawy	173
Twist drill bits HSS-E Co	
Wiertła do metalu HSS-E Co	174
SDS masonry drill bits X-TIP	
Wiertła do betonu SDS, z grotem krzyżowym	174
SDS masonry drill bits	
Wiertła do betonu SDS	175
Masonry drill bits with cylindrical shank & sets	
Wiertła do betonu z uchwytem cylindrycznym i zestawy	175
Flat wood drill bits & sets	
Wiertła łopatkowe do drewna i zestawy	176
Spur wood drill bits	
Wiertła do drewna spiralne	177
Auger wood drill bits & sets	
Świdry do drewna i zestawy	177
Drills for glass	
Wiertła do szkła	178

**Adjustable hand reamers**  
Rozwiertaki nastawne

178



**SDS Chisels**  
Przecinaki i dłuta SDS

178



**Hollow drill sets**  
Wiertła koronowe do betonu

179



**Bi-metal hole saws**  
Otwornice bimetalowe

179-180



Bi-metal hole saws	
Otwornice bimetalowe	179
Arbors for hole saws	
Uchwyty do otwornic bimetalowych	179
Hole saw kits	
Zestawy otwornic bimetalowych	179

**Taps & dies**  
Narzędzia do gwintowania

181-183



Hand taps & sets	
Gwintowniki i zestawy	181
Circular dies	
Narzynki	182
Tap wrenches & die holders	
Pokrętła do gwintowników i narzynek	182
Thread repair sets & accessories	
Zestawy do naprawy gwintów i akcesoria	183

**Router bits**  
Frezy do drewna

184



**Diamond tools**  
Narzędzia diamentowe

185-186



Diamond blades for cutting construction materials	
Tarcze diamentowe do cięcia materiałów budowlanych	185
Diamond blades for cutting concrete	
Tarcze diamentowe do cięcia betonu	185
Diamond blades for cutting stone	
Tarcze diamentowe do cięcia kamienia	185
Diamond blades for cutting ceramic tiles	
Tarcze diamentowe do cięcia płytek ceramicznych	186
Diamond blades for cutting asphalt	
Tarcze diamentowe do cięcia asfaltu	186
Diamond grinding cup wheels	
Diamentowe talerze szlifierskie do betonu i kamienia	186
Diamond core drill bits	
Diamentowe wiertła koronowe	186

**Tungsten carbide tipped tools**  
Narzędzia z ostrzem z węgliku wolframu

187



Tungsten carbide saws for wood	
Tarcze z węglikiem do drewna	187
Tungsten carbide saws for aluminium	
Tarcze z węglikiem do aluminium	187

**Cutting & grinding discs**  
Tarcze do cięcia i szlifowania

187-188



Stainless steel cutting discs	
Tarcze do cięcia stali nierdzewnej	187
Metal cutting discs	
Tarcze do cięcia metalu	187
Metal grinding discs	
Tarcze do szlifowania metalu	188
Stone cutting discs	
Tarcze do cięcia kamienia	188
Stone grinding discs	
Tarcze do szlifowania kamienia	188



**Shears**  
Nożyce

189-193



Heavy duty cable cutters	
Nożyce do cięcia przewodów	189
Tin snips	
Nożyce do blachy	189
Steel strap cutters	
Nożyce do cięcia taśm stalowych	192
Bolt cutters	
Nożyce do prętów	192
Hydraulic cutters & accessories	
Nożyce z siłownikiem hydraulicznym i akcesoria	193
Cable cutters	
Nożyce do kabli	193
Multifunctional scissors	
Nożyce wielofunkcyjne	193



<b>Saws &amp; blades</b>			<b>Punch sets</b>	
<b>Piły i brzeszczoty</b>				
..... 194-200			Przebijaki do skóry..... 208	
<b>Hand saws</b>			<b>Cutters</b>	
Piły do drewna..... 194			Obcinaki..... 209	
<b>Bow saws</b>			<b>Window scrapers</b>	
Piły kabłąkowe..... 194			Skrobaki do szyb..... 211	
<b>Blades</b>			<b>Scrapers</b>	
Brzeszczoty..... 195			Cykliny metalowe..... 211	
<b>Hacksaw frames</b>			<b>Steel files &amp; sets</b>	
Piły do metalu..... 195			Pilniki do metalu i zestawy..... 212	
<b>Hacksaw frame blades</b>			<b>Needle file sets</b>	
Brzeszczoty do metalu..... 195			Zestawy pilników iglaków..... 213	
<b>Jig saw blades</b>			<b>Diamond needle files &amp; sets</b>	
Brzeszczoty do wyrzynarek..... 196			Pilniki iglaki diamentowe i zestawy..... 213	
<b>Accessories for multi-purpose oscillating tools</b>			<b>Rasps &amp; sets</b>	
Akcesoria do wielofunkcyjnych narzędzi oscylacyjnych..... 198			Tarniki do drewna i zestawy..... 215	
<b>Brushes, knives &amp; files</b>			<b>Abrasive products</b>	
<b>Szczotki, noże i pilniki</b>			<b>Artykuły ścierne</b>	
..... 201-215			..... 216-221	
<b>Wire brushes &amp; sets</b>			<b>Sand papers</b>	
Szczotki druciane i zestawy..... 201			Papiery ścierne..... 216	
<b>Cup brushes</b>			<b>Waterproof sand papers</b>	
Szczotki tarczowe..... 203			Papiery ścierne wodoodporne..... 217	
<b>Knives &amp; blades</b>			<b>Abrasive clothes</b>	
Noże i ostrza..... 204			Płótna ścierne..... 218	
<b>Scissors</b>			<b>No end abrasive bands</b>	
Nożyczki..... 207			Taśmy ścierne bezkońcowe..... 218	
<b>Profile gauges</b>			<b>Flap discs</b>	
Wzorniki profili..... 208			Ściernice listkowe..... 219	
			<b>Abrasive sheets and discs</b>	
			Arkusze i krążki ścierne..... 221	

GB Twis dri HSS  
D Me s ira bohrer HSS  
PL Wiertło do metalu HSS  
RUS Свёрло по металлу HSS  
CZ r ák na kov HSS  
H Fúrószár fémhez HSS  
RO Burghiu pt. metal HSS

F Foret métal HSS  
I Punta per metallo HSS  
E Broca para metal HSS  
CN 轧制麻花钻

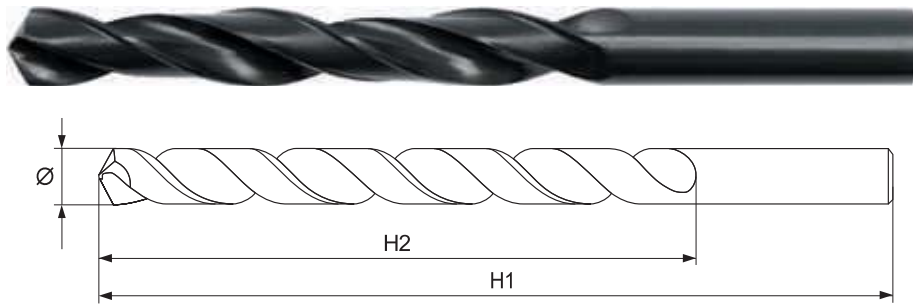
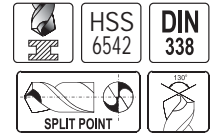

- application: industr
- for precise drilling in steels, cast steels, non ferrous metals, plastics
- przeznaczenie: przemysł
- do precyzyjnych wierceń w stalach, żeliwach, metalach nieżelaznych, tworwach sztucznych



YATO	Ø (mm)	H1 (mm)	H2 (mm)	R.P.M.max.	PCS packing	Box
YT-4430	1.0	34	12	3800	10	80/320
YT-4431	1.5	43	20	3800	10	80/320
YT-4432	2.0	49	24	4000	10	80/320
YT-4433	2.5	57	30	3200	10	80/320
YT-4434	2.8	61	33	2800	10	80/320
YT-4435	3.0	61	33	2600	10	80/320
YT-4436	3.2	65	36	2500	10	80/320
YT-4437	3.5	70	39	2300	10	80/320
YT-4438	4.0	75	43	2000	10	80/320
YT-4439	4.2	75	43	1900	10	20/80
YT-4440	4.5	80	47	1800	10	20/80
YT-4441	4.8	86	52	1600	10	20/80
YT-4442	5.0	86	52	1600	10	20/80
YT-4443	5.2	86	52	1500	10	20/80
YT-4444	5.5	93	57	1500	10	20/80

YATO	Ø (mm)	H1 (mm)	H2 (mm)	R.P.M.max.	PCS packing	Box
YT-4445	6.0	93	57	1300	10	20/80
YT-4446	6.5	101	63	1200	10	10/40
YT-4447	7.0	109	69	1100	10	10/40
YT-4448	7.5	109	69	1100	10	10/40
YT-4449	8.0	117	75	1000	10	10/40
YT-4450	8.5	117	75	900	5	10/40
YT-4451	9.0	125	81	900	5	10/40
YT-4452	9.5	125	81	800	5	10/40
YT-4453	10.0	133	87	800	5	10/40
YT-4454	10.5	133	87	800	3	10/40
YT-4455	11.0	142	94	700	3	10/40
YT-4456	12.0	151	101	700	3	10/40
YT-4457	12.5	151	101	600	3	10/40
YT-4458	13.0	151	101	600	3	10/40

GB Twis dri se  
D Me s ira bohrersa z  
PL Komplet wiertel do metalu  
RUS Набор сверл по металлу  
CZ Souprava vrtáků na kov  
H Fúrószárkészlet fémhez

RO Set de burghie pt. metal  
F Set des forets métal HSS  
I Set punte per metallo  
E Broca para metal  
CN 轧制麻花钻组套

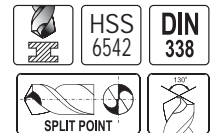

6  
PCS

Ø mm  
2-8

PLASTIC  
HANGING BOX

10  
PCS

Ø mm  
1-10

PLASTIC  
HANGING BOX

19  
PCS

Ø mm  
1-10

PLASTIC  
HANGING BOX

YATO	Ø (mm)	Box
YT-4460	2 3 4 5 6 8	15/60

YATO	Ø (mm)	Box
YT-4461	1 2 3 4 5 6 7 8 9 10	20/40

YATO	Ø (mm)	Box
YT-4462	1.0; 1.5; 2.0; 2.5; 3.0; 3.5; 4.0; 4.5; 5.0; 5.5; 6.0; 6.5; 7.0; 7.5; 8.0; 8.5; 9.0; 9.5; 10.0	15/30

GB Twis dri HSS-COB T H Fűrőszár fémhez HSS-COBALT  
 D Me as ira bohrer HSS-COB T RO Burghiu pt. metal HSS-COBALT  
 PL Wiertło do metalu HSS-COBALT F Foret métal HSS -COBALT  
 RUS Сверло по металлу I Punte per metallo HSS -COBALT  
 HSS-COB T E Broca para metal HSS-COBALT  
 CZ r ák na kov HSS-COB T CN 全磨制含钴麻花钻

<b>DIN 338</b>	<b>HSS-E Co HS6-5-2-5</b> (PN-EN ISO 4957:2002(U))	<b>Rm &gt;900 N/mm<sup>2</sup></b>
	<b>SPLIT POINT</b>	

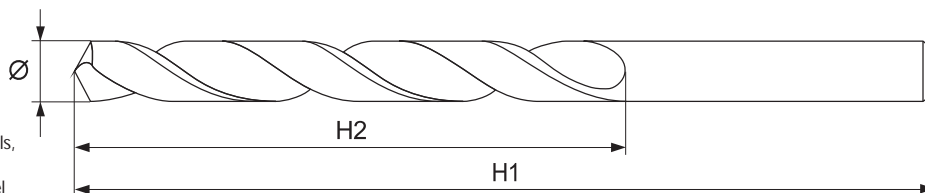

- application: industr
- for precise drilling in hard steels, non ferrous metals, plastics, stainless steel and acid resistant steel
- resistant to high temperatures
- *przeznaczenie: przemysl*
- *do precyzyjnych wierceń w trudnych materiałach, np. stalach szlachetnych, metalach kolorow ch, tworw wach, stalach nierdzewn ch i kwasoodporn ch*
- *odporne na działanie wysokiej temperatury*

BLISTER CARD



YATO	Ø (mm)	H1 (mm)	H2 (mm)	PCS packing	
YT-4020	2.0	49	24	2	125/500
YT-4025	2.5	57	30	2	125/500
YT-4030	3.0	61	33	2	125/500
YT-4032	3.2	65	36	1	100/400
YT-4035	3.5	70	39	1	100/400
YT-4040	4.0	75	43	1	100/400
YT-4042	4.2	75	43	1	100/400
YT-4045	4.5	80	47	1	100/400

YATO	Ø (mm)	H1 (mm)	H2 (mm)	PCS packing	
YT-4048	4.8	86	52	1	100/400
YT-4050	5.0	86	52	1	100/400
YT-4052	5.2	86	52	1	100/400
YT-4055	5.5	93	57	1	100/400
YT-4060	6.0	93	57	1	100/400
YT-4065	6.5	101	63	1	75/300
YT-4070	7.0	109	69	1	75/300
YT-4075	7.5	109	69	1	75/300

YATO	Ø (mm)	H1 (mm)	H2 (mm)	PCS packing	
YT-4080	8.0	117	75	1	75/300
YT-4085	8.5	117	75	1	75/300
YT-4090	9.0	125	81	1	75/300
YT-4100	10.0	133	87	1	75/300
YT-4110	11.0	142	94	1	75/300
YT-4120	12.0	151	101	1	75/300
YT-4140	14.0	160	108	1	25/100
YT-4160	16.0	178	120	1	25/100

10

GB Masonr dri bi X-T P RO Burghiu pt. beton X-TIP  
 D Be ons ira bohrer X-T P F Fore b on à oin e en croi  
 PL Wiertło do betonu X-TIP I Punta per cemento X-TIP  
 RUS Сверло по бетону X-TIP E Broca para hormigón X-TIP  
 CZ r ák na be on X-T P CN 十字头电锤钻  
 H Fűrőszár be onhoz X-T P

	<b>SDS PLUS</b>	<b>X-TIP YG-11C</b>
--	-----------------	---------------------

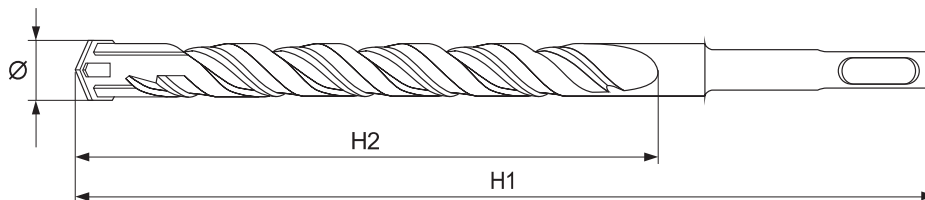

PLASTIC TUBE & PLASTIC HANGER



YATO	Ø (mm)	H1 (mm)	H2 (mm)	PCS packing	
YT-4200	5	110	45	10	300
YT-4201	6	110	45	10	300
YT-4202	6	160	95	10	200
YT-4203	6	210	135	10	150
YT-4204	8	110	45	10	300
YT-4205	8	160	95	10	200
YT-4206	8	210	140	10	150
YT-4207	8	460	370	10	50
YT-4208	8	600	500	10	50
YT-4209	10	160	95	10	150
YT-4210	10	210	140	10	150

YATO	Ø (mm)	H1 (mm)	H2 (mm)	PCS packing	
YT-4211	10	300	220	10	100
YT-4212	10	460	370	10	50
YT-4213	10	600	500	10	50
YT-4214	12	160	95	10	150
YT-4215	12	260	185	10	100
YT-4216	12	460	360	10	50
YT-4217	12	600	490	10	40
YT-4218	14	260	180	10	80
YT-4219	14	460	360	10	40
YT-4220	16	200	125	10	60
YT-4221	16	460	360	10	20

YATO	Ø (mm)	H1 (mm)	H2 (mm)	PCS packing	
YT-4222	16	600	490	10	20
YT-4223	18	460	360	10	20
YT-4224	18	600	490	10	20
YT-4225	20	460	360	5	20
YT-4226	20	600	490	5	20
YT-4227	22	460	360	5	20
YT-4228	22	600	490	5	20
YT-4229	25	460	360	5	20
YT-4230	25	600	490	5	10

GB Masonry drill bit  
D Beonsira bohrer  
PL Wiertło do betonu  
RUS Сверло по бетону

CZ r ák na be on  
H Fúrószár be onhoz  
RO Burghiu pt. beton  
F Fore b on

I Punta per cemento  
E Broca para hormigón  
CN 建工钻



SDS PLUS

3 POINT  
TIP DK-30

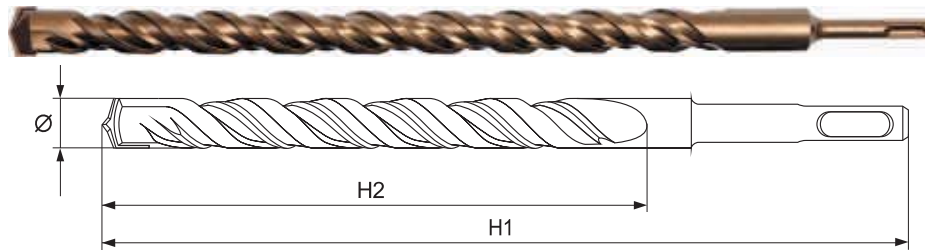

PLASTIC TUBE  
& PLASTIC HANGER



YATO	Ø (mm)	H1 (mm)	H2 (mm)	PCS packing:	
YT-4161	5	110	45	10	300
YT-4162	6	110	45	10	300
YT-4163	6	160	95	10	200
YT-4164	6	210	140	10	150
YT-4165	8	110	45	10	300
YT-4166	8	160	90	10	200
YT-4167	8	210	140	10	150
YT-4168	8	460	370	10	50
YT-4169	8	600	500	10	50
YT-4170	10	160	95	10	150
YT-4171	10	210	140	10	150

YATO	Ø (mm)	H1 (mm)	H2 (mm)	PCS packing:	
YT-4172	10	300	220	10	100
YT-4173	10	460	370	10	50
YT-4174	10	600	500	10	50
YT-4175	12	160	85	10	150
YT-4176	12	260	180	10	100
YT-4177	12	460	360	10	50
YT-4178	12	600	490	10	40
YT-4179	14	260	180	10	80
YT-4180	14	460	360	10	40
YT-4181	16	200	125	10	60
YT-4182	16	300	220	10	50

YATO	Ø (mm)	H1 (mm)	H2 (mm)	PCS packing:	
YT-4183	16	460	360	10	20
YT-4184	16	600	490	10	20
YT-4185	18	460	360	10	20
YT-4186	18	600	490	10	20
YT-4187	20	460	360	5	20
YT-4188	20	600	490	5	20
YT-4189	22	460	360	5	20
YT-4190	22	600	490	5	20
YT-4191	25	460	360	5	20
YT-4192	25	600	490	5	10

GB Masonry drill bit  
D Beonsira bohrer  
PL Wiertło do betonu  
RUS Сверло по бетону  
CZ r ák na be on  
H Fúrószár be onhoz

RO Burghiu pt. beton  
F Fore b on  
I Punta per cemento  
E Broca para hormigón  
CN 建工钻



YG-8C  
HRC 89-90



40CR  
HRC 47

10

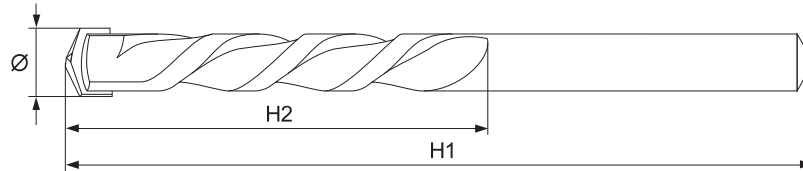

BLISTER CARD



YATO	Ø (mm)	H1 (mm)	H2 (mm)	
YT-4361	4	70	35	100/400
YT-4362	5	90	50	100/400
YT-4363	6	100	60	100/400
YT-4364	6	150	100	100/400
YT-4367	7	100	60	75/300
YT-4369	8	120	80	75/300
YT-4370	8	200	140	50/150

YATO	Ø (mm)	H1 (mm)	H2 (mm)	
YT-4373	9	120	80	75/300
YT-4375	10	120	80	75/300
YT-4376	10	200	140	50/150
YT-4379	12	150	100	50/150
YT-4380	12	200	140	50/150
YT-4383	14	180	120	25/100
YT-4385	16	180	120	25/100

GB Masonry drill bit set  
D Beonsira bohrers z  
PL Komplet wiertło do betonu  
RUS Сверла по бетону в наборе  
CZ Souprava vrtáků do betonu  
H Fúrószárk sz e be onhoz  
RO Set de burghie pt. beton  
F Set des fore s b on  
I Set punte per cemento  
E Brocas para hormigón  
CN 建工钻组套



7  
PCS



YG-8C  
HRC 89-90



40CR  
HRC 47

PLASTIC  
HANGING BOX



YATO	Ø (mm)	
YT-4390	4 5 6 8 9 10 12	10/80

GB Fa wood dri bi  
D Schaufelbohrer  
PL Wiertło łopatkowe do drewna  
RUS Перовые сверло

CZ Pochý vrák  
H Homlokmarós fúró  
RO Burghiu plate  
F Mèche à bois a e

I Punta per legno piatta  
E Broca de a e as  
CN 木工扁钻

DOUBLE BLISTER



1/4" (6.3mm)

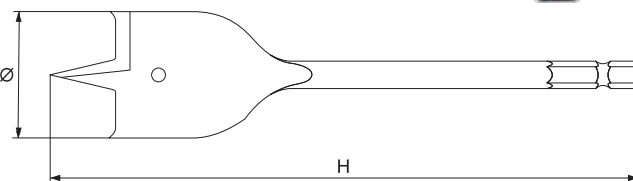

YATO	Ø (mm)	H (mm)	
YT-3236	6	152	50/400
YT-3237	8	152	50/400
YT-3238	10	152	50/300
YT-3239	12	152	50/300
YT-3240	13	152	50/300
YT-3241	14	152	50/300
YT-3242	16	152	50/300
YT-3243	18	152	50/300
YT-3244	20	152	50/300
YT-3245	22	152	50/300

YATO	Ø (mm)	H (mm)	
YT-3246	24	152	50/300
YT-3247	25	152	50/300
YT-3248	26	152	50/300
YT-3249	28	152	50/300
YT-3250	30	152	50/200
YT-3251	32	152	50/200
YT-3252	34	152	50/200
YT-3253	35	152	50/200
YT-3254	38	152	50/200
YT-3255	40	152	50/200

GB Extension for flat wood drill bits  
D Verlängerung für Schaufelbohrer  
PL Przedłużka do wiertel łopatkowych  
RUS Удлинитель для перовых сверл  
CZ Násavec ro och vrák  
H Hosszabbító homlokmarós fáfúrókhoz  
RO Prelungitor pt. burghie plate  
F Rallonge pour mèches à bois  
I Prolunga per punta fresatrice  
E extensión para brocas de a e as  
CN 木工扁钻延长杆

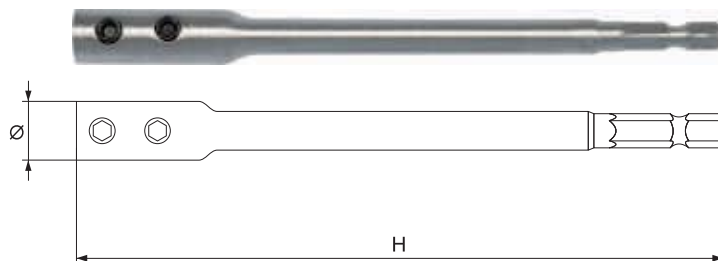

1/4" (6.3mm)

DOUBLE BLISTER



YATO	Ø (mm)	H (mm)	
YT-3256	12.2	150	60/120
YT-3257	13.5	300	30/60

GB Fa wood dri bi se  
D Schaufelbohrersatz  
PL Zestaw wiertel łopatkowych  
RUS Набор перовых сверл  
CZ Sada plochých vrtáků  
H Homlokmarós fáfúró készlet

RO Set burghie plate  
F Set de mèche à bois  
I Set di punte per legno piatta  
E Juego de brocas de aletas  
CN 木工扁钻组套

6 PCS

1/4" (6.3mm)

GB Fa wood dri bi se  
D Schaufelbohrersatz  
PL Zestaw wiertel łopatkowych  
RUS Набор перовых сверл  
CZ Sada plochých vrtáků  
H Homlokmarós fáfúró készlet

RO Set burghie plate  
F Set de mèche à bois  
I Set di punte per legno piatta  
E Juego de brocas de aletas  
CN 木工扁钻组套

8 PCS

1/4" (6.3mm)



POUCH



YATO	Ø (mm)	H (mm)	
YT-3258	10 12 16 18 20 25	152	25/50



PLASTIC CASE & DOUBLE BLISTER



YATO	Ø (mm)	H (mm)	
YT-3259	12 16 18 20 22 25 28 32	152	5/20



GB Spur wood drill bit  
D Spiralbohrer für Holz  
PL Wiertło do drewna spiralne

RUS Спиральное сверло по дереву  
CZ Vrták do dřeva spirálový  
H Csigafúró fához

RO Burghiu spirală pt. lemn  
F M ches h ico da es à bois  
I Punta per legno spirale

E Barrena para madera espiral  
CN 木工钻

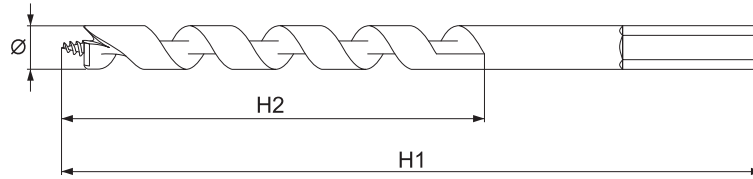

DOUBLE BLISTER



YATO	Ø (mm)	H1 (mm)	H2 (mm)	
YT-4350	3	60	35	30/300
YT-4351	4	75	44	30/300
YT-4352	5	85	52	30/300
YT-4353	6	90	57	30/300
YT-4354	7	100	67	30/300

YATO	Ø (mm)	H1 (mm)	H2 (mm)	
YT-4355	8	110	75	30/300
YT-4356	10	120	77	30/300
YT-4357	12	150	97	15/120
YT-4358	13	150	102	15/120
YT-4359	16	180	120	15/120

GB Auger wood drill bit  
D Ho zbohrer  
PL Świder do drewna

RUS Бур по дереву  
CZ Vrták do dřeva hadovitý  
H Fafúró

RO Burghiu elicoidal pt. lemn  
F Fore s ira e à bois  
I Punta a torciglione per legno

E Barrena para madera  
CN 螺旋木工钻

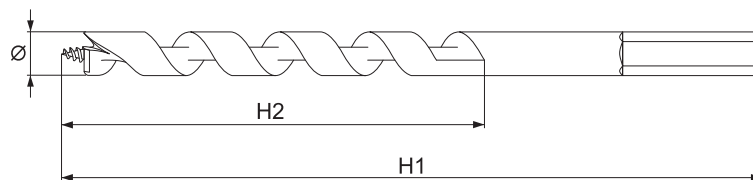

DOUBLE BLISTER

10



YATO	Ø (mm)	H1 (mm)	H1 (mm)	
YT-3261	6	191	121	60/360
YT-3262	8	191	121	70/280
YT-3263	8	400	310	60/120
YT-3264	10	191	121	50/200
YT-3265	10	400	310	50/100
YT-3266	12	191	121	50/150
YT-3267	12	400	310	20/60
YT-3268	13	191	121	50/100
YT-3269	13	400	310	20/60
YT-3270	14	191	121	50/100
YT-3271	14	400	310	20/60
YT-3272	16	191	121	50/100
YT-3273	16	400	310	20/40

YATO	Ø (mm)	H1 (mm)	H1 (mm)	
YT-3274	18	215	142	40/80
YT-3275	18	400	310	20/40
YT-3276	20	215	145	20/60
YT-3277	20	400	310	20/40
YT-3278	22	215	145	20/60
YT-3279	22	400	310	10/30
YT-3280	24	215	145	20/60
YT-3281	24	400	310	6/30
YT-3282	25	215	145	20/40
YT-3283	25	400	310	5/25
YT-3284	26	215	145	10/40
YT-3285	26	400	310	10/20
YT-3286	28	240	145	9/36

YATO	Ø (mm)	H1 (mm)	H1 (mm)	
YT-3287	28	400	310	5/20
YT-3288	30	240	170	10/30
YT-3289	30	400	310	5/10
YT-3290	32	240	170	5/25
YT-3291	32	400	310	5/15
YT-3292	35	240	170	5/20
YT-3293	35	400	310	5/10
YT-3294	36	240	170	10/20
YT-3295	36	400	310	5/10
YT-3296	38	240	170	5/15
YT-3297	40	240	170	5/15

GB Auger wood drill bit set  
D Ho zbohresa z  
PL Zestaw świderów do drewna  
RUS Набор буров по дереву  
CZ Sada hadovitých vrtáků do dřeva  
H Fafúró k sze  
RO Set de burghie elicoidale pt. lemn  
F Set de fore s ira es à bois  
I Set di punte a torciglione  
E Juego de barrenas para madera  
CN 螺旋木工钻组套



WOOD CASE & COLOR BOX



6 PCS	13mm	YATO	Ø (mm)	H (mm)	
		YT-3299	10 12 14 16 18 20	460	8



6 PCS	13mm	YATO	Ø (mm)	H (mm)	
		YT-3298	10 12 14 16 18 20	230	15

6 PCS	SDS PLUS	YATO	Ø (mm)	H (mm)	
		YT-3300	10 12 14 16 18 20	200	20

- GB Drill for glass F Fore à verre  
 D Bohrer für Glas et à ceramique  
 PL Wiertło do szkła I Punta per vetro  
 RUS Сверло по стеклу E Broca ara vidrio  
 CZ Vrták do skla CN 玻璃钻  
 H Üvegfúró  
 RO Burghiu pt. sticlă



YG6X  
 TRANSFER CARBIDE TIP  
 CONTROLLED BREAKING POINT  
**HRA 90**

SLIDING CARD

YATO	Ø (mm)	
YT-3725	4	100/400
YT-3726	6	100/400

YATO	Ø (mm)	
YT-3727	8	100/400
YT-3728	10	50/200

- GB Adjustable hand reamer  
 D ers e bare Reibah e  
 PL Rozwier ak nas awn  
 RUS Регулируемая развертка  
 CZ Nastavitelný výstružník  
 H ha ó dorzsár  
 RO Alezor reglabil  
 F Alesoir à main réglable  
 I Alesatore regolabile  
 E Escariador ajustable  
 CN 可调式用手铰刀



**HSS 4241**

PLASTIC TUBE

YATO	working diameter / średnica robocza (mm <sup>2</sup> )	L (mm)	arbor diameter / średnica trzpienia (mm <sup>2</sup> )	
YT-28950	7.75-8.5	107	4.5	50/200
YT-28951	8.5-9.25	112	4.5	50/200
YT-28952	9.25-10	116	5.0	50/200
YT-28953	10-10.75	125	5.5	50/200
YT-28954	10.75-11.75	130	6.5	50/200
YT-28955	11.75-12.75	135	7.5	50/150
YT-28956	12.75-13.75	140	7.5	50/150
YT-28957	13.75-15.25	158	8.0	20/60
YT-28958	15.25-17	165	9.0	20/60

YATO	working diameter / średnica robocza (mm <sup>2</sup> )	L (mm)	arbor diameter / średnica trzpienia (mm <sup>2</sup> )	
YT-28959	17-19	175	10.0	20/60
YT-28960	19-21	180	11.5	20/60
YT-28961	21-23	193	13.5	20/40
YT-28962	23-26	210	15.4	4/20
YT-28963	26-29.5	245	17.0	4/20
YT-28964	29.5-33.5	270	19.0	4/12
YT-28965	33.5-38	310	21.0	2/10
YT-28966	38-44	345	24.0	2/10
YT-28967	44-54	400	30.0	5

- GB Poin chise SDS RUS Зубило SDS+ RO Punctator SDS+ E Cincel puntiagudo SDS+  
 D Spitzmeissel SDS+ CZ Sekáč špičák SDS+ F Per oir SDS CN SDS尖凿  
 PL Przecinak SDS H Hegyes véső SDS+ I Sca e o SDS

4x14  
x250  
mm **SDS PLUS** **CrV**



PLASTIC HANGER



YATO	L (mm)	
YT-4720	250	6/48

- GB Flat chise SDS RUS Долото узкое SDS+ RO Punctator pt. adancit SDS+ E Cince ane es recho SDS  
 D Flachmeissel SDS+ CZ Sekáč plochý SDS+ F Ciseau SDS+ CN SDS平凿  
 PL Dłuto wąskie SDS+ H Lapos véső SDS+ I Scalpello punto stretto SDS+

20x14  
x250  
mm **SDS PLUS** **CrV**



PLASTIC HANGER



YATO	L (mm)	
YT-4721	250	6/48

- GB Hollow chise SDS RUS Бороздник SDS+ RO Punctator pt. adancit SDS+ E Cince acana ado SDS  
 D Nutenmeissel SDS+ CZ Sekáč drážkovací SDS+ F Burin à entailler SDS+ CN SDS空心凿  
 PL Bruzdownik SDS+ H Horonyvéső SDS+ I Caibro sca e o SDS

22x18  
x250  
mm **SDS PLUS** **CrV**



PLASTIC HANGER



YATO	L (mm)	
YT-4722	250	6/48

- GB Flat chise SDS RUS Долото плоское SDS+ RO Punctator tip dalta SDS+ E Cince ane SDS  
 D Spatmeissel SDS+ CZ Sekáč plochý SDS+ F Ciseau SDS+ CN SDS平凿  
 PL Dłuto płaskie SDS+ H Széles lapos véső SDS+ I Sca e o ia o SDS

40x14  
x250  
mm **SDS PLUS** **CrV**



PLASTIC HANGER



YATO	L (mm)	
YT-4723	250	6/48

GB Ho ow dri se CZ Korunový vrták na zeď I Punta a corona per calcestruzzo  
D Bohrkrona H Koronafúró fa hoz E Broca widia para muro  
PL Wiertło koronowe do betonu RO Burghiu cu coroaă pt. beton CN 扩孔钻  
RUS Сверла по бетону корончатые F Trépid à mur

COLOR BOX



**HEX**  
12mm

**SDS**  
PLUS

YATO	Ø (mm)	T	T	☐
YT-4400	65	6	6	24
YT-4401	80	8	8	20

YATO	Ø (mm)	T	T	☐
YT-4402	65	6	6	24
YT-4403	80	8	8	20

GB Bi-metal hole saw  
D Bimetall-Lochsäge  
PL Otwornica bimetalowa  
RUS Ножовка к отверстиям би-металлическая  
CZ Vrtací korunka bimetalová  
H Bi-metál koronafúró  
RO Găurăritori bimetali  
F Scie-trépan bimétal  
I Foro sega utensile da taglio bi-metallo  
E Sierra de marquetería bi-metálica  
CN 双金属孔锯

- application: industr
- to drill holes in stainless steels, cast steels, aluminium, wood, plastics
- cutting depth: mm
- przeznaczenie: przemysł
- do wycinania otworów w stalach nierdzewnych, żeliwie, aluminium, drewnie, tworzyw sztucznych
- głębokość cięcia: 40 mm



**BI-METAL**

**HSS M3**

**ALLOY STEEL**

**4-6 TPI**

**40mm**

10

YATO	Ø (mm)	t rea / gwint	☐
YT-3303	19	1/2" (12.5 mm)	25/100
YT-3304	20	1/2" (12.5 mm)	25/100
YT-3306	22	1/2" (12.5 mm)	25/100
YT-3308	25	1/2" (12.5 mm)	25/100
YT-3311	29	1/2" (12.5 mm)	25/100
YT-3313	32	5/8" (16 mm)	25/100
YT-3315	35	5/8" (16 mm)	25/100
YT-3317	38	5/8" (16 mm)	25/100
YT-3318	40	5/8" (16 mm)	25/100
YT-3321	44	5/8" (16 mm)	25/100

YATO	Ø (mm)	t rea / gwint	☐
YT-3322	46	5/8" (16 mm)	25/100
YT-3323	48	5/8" (16 mm)	25/100
YT-3324	51	5/8" (16 mm)	25/100
YT-3327	57	5/8" (16 mm)	25/50
YT-3329	60	5/8" (16 mm)	25/50
YT-3330	64	5/8" (16 mm)	25/50
YT-3332	67	5/8" (16 mm)	25/50
YT-3333	68	5/8" (16 mm)	25/50
YT-3334	70	5/8" (16 mm)	25/50
YT-3336	76	5/8" (16 mm)	25/50

YATO	Ø (mm)	t rea / gwint	☐
YT-3338	83	5/8" (16 mm)	25/50
YT-3343	95	5/8" (16 mm)	25/50
YT-3345	102	5/8" (16 mm)	10/20
YT-3346	105	5/8" (16 mm)	10/20
YT-3349	114	5/8" (16 mm)	10/20
YT-3350	121	5/8" (16 mm)	10/20
YT-3351	127	5/8" (16 mm)	10/20
YT-3353	140	5/8" (16 mm)	10/20

GB rbor for ho e saw H Befogószár a koronafúróhoz I Pergolato per sega  
D Halterung für Lochsägen RO Dis ozi iv de an renare E Mango para las sierras  
PL Uchw do o wornic pt. găurăritori bimetali de marquetería  
RUS Ружья к ножовке F Mandrin aux scies-trépan CN 孔锯柄轴

**HEX**

**SDS**  
**PLUS**



**1/2"**  
**(12.5mm)**  
**20UNF**

DOUBLE  
BLISTER

**5/8"**  
**(16 mm)**  
**18UNF**

DOUBLE  
BLISTER

YATO	SDS / H	☐
YT-3370	HEX 7/16" (11 mm)	25/100
YT-3373	SDS	25/100

YATO	SDS / H	☐
YT-3371	HEX 7/16" (11 mm)	25/100
YT-3372	HEX 7/16" (11 mm)	25/50
YT-3374	SDS	25/50

GB Pi o dri CZ Středící vrták I Punta pilota  
D Pi o bohrer H Köz on fúró E Broca io o  
PL Wiertło pilot RO Burghiu pilot CN 导向钻  
RUS Сверло пилот F Fore - io

**HSS**



YATO	Ø (mm)	H (mm)	☐
YT-3376	6.0	75	25/100

YATO	Ø (mm)	H (mm)	☐
YT-3377	6.0	100	25/100

- GB Combination hole saw kit
- D Lochsägensatz für Elektriker
- PL Zesawo wornic dla elektryków
- RUS Набор ножовок к отверстиям для электриков
- CZ Sada vrtacích korunek pro elektrikáře
- H Koronafúró készlet villanyszerelőknek
- RO Set de găuritori pt. electricieni
- F Set de scies trépan aux électriciens
- I Set universale a tazza fresa con strumenti
- E Juego de sierras de marquetería para electricistas
- CN 双金属开孔器组套

8 PCS	BI-METAL	HSS M3
ALLOY STEEL	4-6 TPI	40mm



BMC & COLOR SLEEVE

YATO	Ø (mm)	
YT-3380	22 29 35 44 67 73	10

10

- GB Combination hole saw kit
- D Universal-Lochsägensatz
- PL Uniwersalny zesawo wornic
- RUS Универсальный набор ножовок к отверстиям
- CZ Univerzální sada vrtacích korunek
- H Univerzális koronafúró készlet
- RO Set univesal de găuritori
- F Set de scies trépan universelles
- I Set universale a tazza fresa con strumenti
- E Juego universal de sierras de marquetería
- CN 双金属开孔器组套

15 PCS	BI-METAL	HSS M3
ALLOY STEEL	4-6 TPI	40mm



BMC & COLOR SLEEVE

YATO	Ø (mm)	
YT-3381	19 22 25 32 35 38 44 51 57 64 76	5

GB Hand a  
D Handgewindebohrer  
PL Gwintownik ręczny  
RUS Ручной метчик  
CZ Závitník  
H Mene fűró

RO Tarozii  
F Taraud à main  
I Maschi filettatura a mano  
E Machos de rosca  
CN 三件套手动丝锥



SLIDING CARD



3  
PCS

DIN  
352

HSS  
M2

3-STAGE  
TAPPING

METRIC  
COARSE

YATO	size x pitch rozmiar x skok gwintu	t rea engt (mm) długość gwintu (mm)	L (mm)	an iiameter (mm) średnica trzonu (mm)	PCS packing:	weig t (g) waga (g)	
YT-2930	M3x0.5	11	40	3.5	3	25	100/400
YT-2931	M4x0.7	13	45	4.5	3	35	50/200
YT-2932	M5x0.8	16	50	6.0	3	45	60/240
YT-2933	M6x1.0	19	50	6.0	3	45	60/240
YT-2934	M7x1.0	19	50	6.0	3	55	75/300
YT-2935	M8x1.25	22	56	6.0	3	60	50/200
YT-2937	M10x1.5	24	70	7.0	3	85	50/200

YATO	size x pitch rozmiar x skok gwintu	t rea engt (mm) długość gwintu (mm)	L (mm)	an iiameter (mm) średnica trzonu (mm)	PCS packing:	weig t (g) waga (g)	
YT-2939	M12x1.75	29	75	9.0	3	125	50/200
YT-2940	M14x2.0	30	80	10.5	3	200	20/80
YT-2941	M16x2.0	32	80	11.0	3	235	20/80
YT-2942	M18x2.5	40	95	12.0	3	345	20/80
YT-2943	M20x2.5	40	95	14.0	3	445	10/40
YT-2926	M22x2.5	40	100	18.0	3	600	10/40
YT-2927	M24x3.0	50	110	18.0	3	700	15/30

GB Machine a  
D Maschinengewindebohrer  
PL Gwintownik maszynowy  
RUS Машинный метчик  
CZ S ron závitník  
H Gépi menetfűró

RO Tarod de mașină  
F Taraud machine  
I Maschi filettatura  
E Macho mecanico  
CN 机用丝锥

DIN  
371M

HSS  
M2

1-STAGE  
TAPPING

METRIC  
COARSE

GB Machine a  
D Maschinengewindebohrer  
PL Gwintownik maszynowy  
RUS Машинный метчик  
CZ S ron závitník  
H Gépi menetfűró

RO Tarod de mașină  
F Taraud machine  
I Maschi filettatura  
E Macho mecanico  
CN 机用丝锥

DIN  
376

HSS  
M2

1-STAGE  
TAPPING

METRIC  
COARSE



SLIDING CARD



SLIDING CARD



YATO	size x pitch rozmiar x skok gwintu	t rea engt (mm) długość gwintu (mm)	L (mm)	an iiameter (mm) średnica trzonu (mm)	weig t (g) waga (g)	
YT-2950	M3x0.5	11	56	3.5	15	100/400
YT-2951	M4x0.7	13	63	4.5	20	100/400
YT-2952	M5x0.8	16	70	6.0	25	60/240
YT-2953	M6x1.0	19	80	6.0	30	50/200
YT-2954	M7x1.0	19	80	7.1	35	30/120
YT-2955	M8x1.25	22	90	8.0	45	50/200
YT-2956	M10x1.5	24	100	10.0	65	50/200

YATO	size x pitch rozmiar x skok gwintu	t rea engt (mm) długość gwintu (mm)	L (mm)	an iiameter (mm) średnica trzonu (mm)	weig t (g) waga (g)	
YT-2944	M12x1.75	29	110	9.0	70	25/100
YT-2945	M14x2.0	30	110	11.0	110	25/100
YT-2946	M16x2.0	32	110	12.0	120	25/100
YT-2947	M18x2.5	34	125	14.0	200	25/100
YT-2948	M20x2.5	34	140	16.0	260	25/100
YT-2949	M22x2.5	34	140	18.0	340	20/80
YT-2957	M24x3.0	38	160	18.0	400	15/60
YT-2958	M27x3.0	38	160	20.0	500	15/60
YT-2959	M30x3.5	45	180	22.0	700	15/60

GB Ta s and dies se  
D Gewindefschneidwerkzeug-Satz  
PL Zestaw narzynek i gwintowników  
RUS Набор плашек и метчиков  
CZ Souprava závitníků  
a kruhových závitových čelistí  
H Menetfűró és menetvágó készlet  
RO Set de tarozii și filiere  
F Set de filières et tarauds  
I Set di filiera a maschi  
E Juego de machos de rosca y cojinetes  
CN 丝锥板牙组套

METAL CASE  
& COLOR BOX



HSS



44  
PCS

DIN223  
DIN225  
DIN352  
DIN1814



YATO	size / rozmiar	
YT-2978	M3 M4 M5 M6 M8 M10 M12	4



32  
PCS

DIN223  
DIN352

YATO	size / rozmiar	
YT-2975	M3 M4 M5 M6 M8 M10 M12	10



56  
PCS

DIN223  
DIN225  
DIN352  
DIN1814

YATO	size / rozmiar	
YT-2979	M3 M4 M5 M6 M8 M10 M12 M14 M16 M18 M20	2

GB Tasse  
D Gewindeschneidwerkzeug-Satz  
PL Zestaw gwintowników  
RUS Набор метчиков  
CZ Souprava závitníků  
H Menefúrók sze  
RO Se de arozi  
F Set de tarauds  
I Set di filettature  
E Juego de machos de roscar  
CN 丝锥组套



21  
PCS

DIN  
352

29  
PCS

DIN338  
DIN352  
DIN1814



YATO	size / rozmiar	
YT-2976	M3 M4 M5 M6 M8 M10 M12	20

YATO	size / rozmiar	
YT-2977	M3 M4 M5 M6 M8 M10 M12	12

GB Circular die  
D Schneideisen  
PL Narz nka  
RUS Плашка  
CZ Kruhová závitová čelist

H Menetvágó  
RO Filieră  
F Fii re  
I Fii re onde  
E Co ine e de roscar  
CN 圆板牙



10

SLIDING CARD



YATO	size x pitch rozmiar x skok gwintu	outside diameter (mm) średnica zewnętrzna (mm)	thickness (mm) grubość (mm)	weig t (g) waga (g)	
YT-2961	M4x0.7	20	5	20	125/500
YT-2962	M5x0.8	20	7	20	100/400
YT-2963	M6x1.0	20	7	20	100/400
YT-2964	M7x1.0	25	9	35	100/200
YT-2965	M8x1.25	25	9	35	100/400
YT-2967	M10x1.5	30	11	50	70/280
YT-2969	M12x1.75	38	14	90	60/240
YT-2970	M14x2.0	38	14	95	63/252

YATO	size x pitch rozmiar x skok gwintu	outside diameter (mm) średnica zewnętrzna (mm)	thickness (mm) grubość (mm)	weig t (g) waga (g)	
YT-2971	M16x2.0	45	18	160	50/200
YT-2972	M18x2.5	45	18	160	50/200
YT-2973	M20x2.5	45	18	150	50/200
YT-2960	M22x2.5	55	22	300	20/80
YT-2966	M24x3.0	55	22	300	20/80
YT-2968	M27x3.0	65	25	400	15/60
YT-2974	M30x3.5	65	25	400	15/60

GB T-hand e a wrench  
D Werkzeughalter für Gewinde  
PL Pokrętko typu „T”  
do gwintowników  
RUS Рукоятка типа „T”  
к гаечному ключу  
CZ Vratidlo na závitníky typ „T”  
H Menetfúró befogó T-nyelű  
RO Port tarod cu maner  
F Porte-taraud type „T”  
I Chiave giramaschio tipo „T” per maschi  
E Llave giramachos „T”  
CN 丝锥铰手



SLIDING CARD

YATO	size / rozmiar	L (mm)	
YT-2986	M3-M8	70	20/80
YT-2987	M5-M10	80	20/80
YT-2988	M6-M12	90	20/80

GB Ra che a wrench  
D Werkzeughalter  
PL Grzechotka do gwintownika  
RUS Трещетка для метчика  
CZ Řečtačka na závitník  
H Racsnis hajtászár menetfúróhoz  
RO Por arod  
F Porte-taraud à cliquet  
I Chiave giramaschi a cricchetto  
E Carraca para macho de roscar  
CN 棘轮丝锥铰手



SLIDING CARD

YATO	size / rozmiar	L (mm)	
YT-2989	M3-M10	85	20/80
YT-2997	M3-M10	250	20/80
YT-2990	M5-M12	100	20/80
YT-2991	M5-M12	300	20/40

GB Die hand e  
D Schneideisenha er  
PL O rawa do narz nek  
RUS Плашкодержатель

CZ Závitová objímka  
H Menetvágó tartó  
RO Portfilieră  
F Porte-filière

I Porta filiere  
E Por aco ine e  
CN 板牙铰手



SLIDING CARD

YATO	size / rozmiar	Ø (mm)	L (mm)	
YT-2980	M3-M4	20 5	200	25/100
YT-2981	M4.5-M6	20 7	200	25/100
YT-2982	M7-M9	25 9	224	25/100
YT-2983	M10-M11	30 11	280	25/50
YT-2984	M12-M14	38 14	315	15/30
YT-2985	M16-M20	45 18	450	10/20

GB Ta wrench  
D Werkzeughalter für Gewinde  
PL Pokrętko do gwintowników

RUS Вороток для метчиков  
CZ Ovládací kolečko na závitník  
H Hajtászár menetfúróhoz

RO Cheie (mâner) pt. tarod  
F Porte-taraud  
I Manopola per il maschio

E Llave giramachos  
CN 一型丝锥铰手



SLIDING CARD

YATO	size / rozmiar	L (mm)	
YT-2995	M1-M8	125	50/200
YT-2996	M3-M10	180	25/100
YT-2992	M3-M12	200	25/100
YT-2993	M4-M12	280	25/100
YT-2994	M5-M20	375	20/40

- GB Thread re-amer  
D Reparatursatz für Gewinde  
PL Zestaw do naprawy gwintów  
RUS Набор для ремонта резьбы  
CZ Souprava na opravu závitů  
H Mene avók sze  
RO Set pt. reparare filete
- F Se d'heicois  
I Ki di ri arazione per filettature  
E Juego para reparar roscas  
CN 螺纹修复组套





METAL BOX & COLOR BOX

**HSS 4341**  
STAINLESS STEEL  
STAL NERDZEWNA





**88**  
PCS

YATO 	size / rozmiar	
YT-1769	M6 x 1.0 x 10.8 mm	5/10
	M8 x 1.25 x 10.8 mm	
	M10 x 1.5 x 13.5 mm	



**131**  
PCS

YATO 	size / rozmiar	
YT-1763	M5 x 0.8 x 6.7 mm	5/10
	M6 x 1.0 x 10.8 mm	
	M8 x 1.25 x 10.8 mm	
	M10 x 1.5 x 13.5 mm	
	M12 x 1.75 x 16.3 mm	



for / dla: YT-1763, YT-1769

STAINLESS STEEL  
STAL NERDZEWNA

- GB Wire threads  
D Spiraleinlagen für Gewindereparatur  
PL Wkłady spiralne do naprawy gwintów  
RUS Метчики и сверла для ремонта резьбы  
CZ Spirálové vložky na opravu závitů  
H Mene avó beék  
RO Insertii spirală pt. reparare filete  
F Heicois  
I nseri s'ira e erri arazione  
E Elementos espirales para reparar roscas  
CN 螺纹修复组套



POLYBAG WITH HEADER

YATO 	size / rozmiar	PCS packing:	
YT-1764	M5 x 0.8 x 6.7 mm	20	50/250
YT-1765	M6 x 1.0 x 10.8 mm	20	50/250
YT-1766	M8 x 1.25 x 10.8 mm	20	50/200
YT-1767	M10 x 1.5 x 13.5 mm	15	25/100
YT-1768	M12 x 1.75 x 16.3 mm	10	25/100

GB Router bit set  
 D Oberfräsersatz  
 PL Zes aw frezów do drewna  
 RUS Набор фрез по дереву  
 CZ Souprava frézů do dřeva  
 H Medtjo frezů kompletas  
 RO Set de freze pt. lemn  
 F Fraises pour le bois  
 I Set di frese per legno  
 E Juego de frezas para madera  
 CN 木工铣刀组套



ALUMINIUM CASE & COLOR SLEEVE

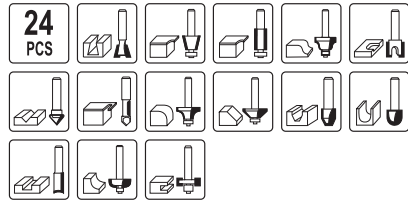

**YATO**  
YT-6801 10

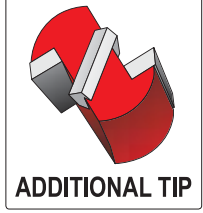

Router bit parameter												
Shank diameter [mm]	8	8	8	8	8	8	8	8	8	8	8	8
Length [mm]	42.0	47.0	47.0	43.5	50.0	51.5	51.0	52.0	58.0	51.5	58.0	56.5
Router bit diameter [mm]	12.7	12.7	9.5	12.7	12.7	9.5	12.7	16.0	6.35	6.35	9.5	12.7
Cutting edge length [mm]	12.7	14.8	11.6	13.0	12.5	20.0	20.0	9.5	19.5	20.0	24.5	25.0
Curvature radius [mm]	-	-	-	-	-	4.75	6.35	-	-	-	-	-
Bearing diameter [mm]	-	-	-	-	-	-	-	12.7	-	-	-	-
Angle [°]	-	15	10	-	45	-	-	15	-	-	-	-
Router bit parameter												
Shank diameter [mm]	8	8	8	8	8	8	8	8	8	8	8	8
Length [mm]	52.0	65.0	51.0	51.5	53.5	57.5	50.5	53.5	52.0	55.0	50.0	54.0
Router bit diameter [mm]	19.0	12.7	19.0	22.0	26.0	32.0	22.0	28.5	27.0	30.0	32.0	32.0
Cutting edge length [mm]	20.4	25.0	9.5	10.0	11.5	16.5	9.72	13.5	12.3	14.0	6.35	12.7
Curvature radius [mm]	-	-	3.2	4.76	6.35	9.5	6.35	9.5	4.0	-	-	-
Bearing diameter [mm]	-	12.7	-	12.7	12.7	12.7	9.5	9.5	9.5	12.7	12.7	12.7
Angle [°]	-	-	-	-	-	-	-	-	-	45	-	-

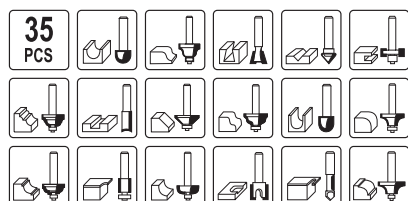

**YATO**  
YT-6803 10

Router bit parameter																									
Shank diameter [mm]	8	8	8	8	8	8	8	8	8	8	8	8	8	8	8	8	8	8	8	8	8	8	8	8	
Length [mm]	43.0	38.0	38.0	50.5	42.0	43.5	51.5	49.5	51.5	58.0	58.5	56.5	52.0	58.0	53.5	66.0	53.0	65.0	-	-	-	-	-	-	
Router bit diameter [mm]	6.35	12.7	12.7	12.7	12.7	12.7	14.3	3.175	6.35	9.5	12.7	12.7	19.0	6.35	9.5	9.5	12.7	12.7	-	-	-	-	-	-	
Cutting edge length [mm]	6.0	9.5	9.5	18.0	12.7	13.0	12.3	13.0	20.0	24.5	20.3	25.0	20.4	19.5	15.0	26.0	15.0	25.0	-	-	-	-	-	-	
Curvature radius [mm]	3.175	6.35	-	6.35	-	-	-	-	-	-	-	-	-	-	-	-	-	-	-	-	-	-	-	-	
Bearing diameter [mm]	-	-	-	-	-	-	-	-	-	-	-	-	-	-	-	9.5	9.5	12.7	12.7	-	-	-	-	-	
Angle [°]	-	-	45	-	-	10	14	-	-	-	-	-	-	-	-	-	-	-	-	-	-	-	-	-	
Router bit parameter																									
Shank diameter [mm]	8	8	8	8	8	8	8	8	8	8	8	8	8	8	8	8	8	8	8	8	8	8	8	-	
Length [mm]	65.5	55.0	51.0	55.0	50.0	52.5	54.0	55.5	60.0	60.0	56.0	60.0	52.5	58.0	53.5	57.5	61.0	-	-	-	-	-	-	-	
Router bit diameter [mm]	19.0	30.0	26.0	32.0	32.0	32.0	32.0	32.0	32.0	38.0	32.0	38.0	26.0	38.0	26.0	32.0	38.0	-	-	-	-	-	-	-	
Cutting edge length [mm]	26.0	14.0	9.7	13.3	6.35	8.0	9.5	15.0	18.5	20.0	16.0	19.0	12.5	17.8	11.5	16.5	20.8	-	-	-	-	-	-	-	
Curvature radius [mm]	-	-	6.35	9.5	-	-	-	8.0	4.76	12.7	4.76	6.35	3.175	6.35	6.35	9.5	12.7	-	-	-	-	-	-	-	
Bearing diameter [mm]	19.0	12.7	12.7	12.7	12.7	12.7	12.7	9.5	12.7	9.5	9.5	9.5	9.5	9.5	9.5	12.7	12.7	-	-	-	-	-	-	-	
Angle [°]	-	45	-	-	-	-	-	-	-	-	-	-	-	-	-	-	-	-	-	-	-	-	-	-	



GB Diamond blade  
D Diamant-Trennscheibe  
PL Tarcza diamentowa  
RUS Отрезной алмазный диск  
CZ Diamantový kotouč  
H Gyémántkorong

RO Discu cu diamant  
F Disque diamant  
I Disco diamantato  
E Disco de diamante  
CN 金刚石切片

DOUBLE  
BLISTER

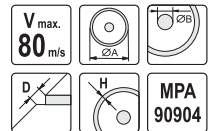

- application: concrete, brick, tile, masonr , stone
- przeznaczenie: beton utwardzony, cegła, granit, mur, kamień

- application: ceramic, glaze, glass, porcelain
- przeznaczenie: płytki ceramiczne, glazura, płytki kamienne, szkło, porcelana

- application: concrete, brick, tile, masonr , stone, sandstone
- przeznaczenie: beton utwardzony, cegła, granit, mur, kamień, piaskowiec

YATO	∅A (mm)	∅B (mm)	R.P.M.max.	D (mm)	H (mm)	Box
YT-6002	115	22.2	12000	2.1	8.0	20/200
YT-6003	125	22.2	11000	2.2	8.0	20/160
YT-6004	180	22.2	8000	2.5	8.0	15/60
YT-6005	230	22.2	6500	2.7	8.0	10/40

YATO	∅A (mm)	∅B (mm)	R.P.M.max.	D (mm)	H (mm)	Box
YT-6012	115	22.2	12000	2.1	5.3	20/200
YT-6013	125	22.2	11000	2.2	5.3	20/160
YT-6014	180	22.2	8000	2.5	5.3	15/60
YT-6015	230	22.2	6500	2.7	5.3	10/40
YT-6016	180	25.4	8000	2.2	5.3	15/60
YT-6017	200	25.4	8000	2.2	5.3	10/40

YATO	∅A (mm)	∅B (mm)	R.P.M.max.	D (mm)	H (mm)	Box
YT-6022	115	22.2	12000	2.4	8.0	20/200
YT-6023	125	22.2	11000	2.6	8.0	20/160
YT-6024	180	22.2	8000	2.8	8.0	15/60
YT-6025	230	22.2	6500	3.1	8.0	10/40

GB Diamond blade  
D Diamant-Trennscheibe  
PL Tarcza diamentowa  
RUS Отрезной алмазный диск  
CZ Diamantový kotouč  
H Gyémántkorong

RO Discu cu diamant  
F Disque diamant  
I Disco diamantato  
E Disco de diamante  
CN 金刚石切片

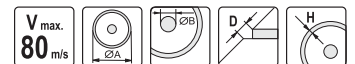

DOUBLE BLISTER



PAPER ENVELOPE



- application: concrete, reinforced concrete, clinkier, brick
- przeznaczenie: beton, beton zbrojony, klinkier, cegła

- application: concrete, reinforced concrete, clinkier, brick
- przeznaczenie: beton, beton zbrojony, klinkier, cegła

YATO	∅A (mm)	∅B (mm)	R.P.M.max.	D (mm)	H (mm)	Box
YT-5953	300	25.4	5100	3.0	10.0	10
YT-5954	350	25.4	4300	3.2	10.0	5
YT-5955	400	25.4	3800	3.6	10.0	5

YATO	∅A (mm)	∅B (mm)	R.P.M.max.	D (mm)	H (mm)	Box
YT-5956	450	25.4	3400	3.8	10.0	5



DOUBLE BLISTER



PAPER ENVELOPE



- application: natural stone, artificial stone
- przeznaczenie: kamień naturalny, kamień sztuczny

- application: natural stone, artificial stone
- przeznaczenie: kamień naturalny, kamień sztuczny

YATO	∅A (mm)	∅B (mm)	R.P.M.max.	D (mm)	H (mm)	Box
YT-5965	400	25.4	3800	3.6	10.0	5

YATO	∅A (mm)	∅B (mm)	R.P.M.max.	D (mm)	H (mm)	Box
YT-5966	450	25.4	3400	3.8	10.0	5

- GB Diamond blade
- D Diamant-Trennscheibe
- PL Tarcza diamentowa
- RUS Отрезной алмазный диск
- CZ Diamantový kotouč
- H Gyémántkorong
- RO Disc cu diamant
- F Disque diamant
- I Disco diamantato
- E Disco de diamante
- CN 金刚石切片



- application: ceramic tiles, thin natural stone tiles, glaze, glass, porcelain
- przeznaczenie: płytki ceramiczne, cienkie płytki z naturalnego kamienia, glazura, szkło, porcelana

DOUBLE BLISTER



- application: asphalt, checker brick, silicate, chamotte, fresh concrete materials, other ceramic building materials
- przeznaczenie: asfalt, cegła „kratówka”, silikaty, szamot, świeży beton, inne ściernalne materiały budowlane

DOUBLE BLISTER



YATO	∅A (mm)	∅B (mm)	R.P.M.max.	D (mm)	H (mm)	Box
YT-5973	250	25.4	6100	1.8	10.0	20
YT-5974	300	25.4	5100	2.1	10.0	10
YT-5975	350	25.4	4300	2.4	10.0	5

YATO	∅A (mm)	∅B (mm)	R.P.M.max.	D (mm)	H (mm)	Box
YT-5991	300	25.4	5100	3.2	10.0	10
YT-5992	350	25.4	4300	3.2	10.0	5

10



- application: asphalt, checker brick, silicate, chamotte, fresh concrete materials, other ceramic building materials
- przeznaczenie: asfalt, cegła „kratówka”, silikaty, szamot, świeży beton, inne ściernalne materiały budowlane

PAPER ENVELOPE



YATO	∅A (mm)	∅B (mm)	R.P.M.max.	D (mm)	H (mm)	Box
YT-5994	450	25.4	3400	3.6	10.0	5

- GB Diamond grinding cup wheel
- D Diamant Schleiftopf Schleifteller
- PL Tarcza szlifierska diamentowa
- RUS Алмазный диск шлифовальный
- CZ Diamantový brusný kotouč
- H Gyémánt csiszoló kúpos
- RO Disc cupa diamantat pt. slefuit
- F Disque diamant
- I Disco diamantato
- E Disco diamante de lijat
- CN 金刚石杯型磨轮

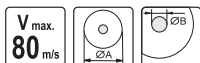

HANGING COLOR BOX



- application: concrete, clinker, natural stone
- przeznaczenie: beton, klinkier, kamień naturalny

YATO	∅A (mm)	∅B (mm)	R.P.M.max.	segment size (mm)	Box
YT-6030	125	22.2	12200	5.0x7.5	20
YT-6032	125	22.2	12200	4.5x20.0	20

- GB Diamond core bit drilling holes for sockets
- D Diamant-Bohrkrone
- PL Diamantowe wiertło koronowe
- RUS Алмазное сверло корончатое
- CZ Diamantový korunkový vrták
- H Gyémánt fúrókorona
- RO Carota diamantata pt. beton
- F Trépiéd à mur diamantées
- I Corona diamantata per calcestruzzo
- E Corona con broca diamante
- CN 金刚石薄壁钻



COLOR BOX



YATO	∅ (mm)	R.P.M.max.	segment size (mm)	Box
YT-6045	68	1030	3.5x10x24	24
YT-6046	82	850	3.5x10x24	20

GB TCT circular saw blade for wood  
D Kreissägeblatt HM-Bestückt  
PL Piła tarczowa do drewna z węglikiem wolframu  
RUS Диск пильный с карбидом вольфрама

CZ Kotoučová pila na dřevo z karbidem wolframu  
H Wolframkarbidos körfűrész fához  
RO Ferăstrău circular cu diniți din wolfram pt. lemn

F Lame de scie circulaire carburé  
I Lama troncatrice taglio legno  
E Disco de sierra con carbono de tungsteno  
CN 木工锯片

DOUBLE BLISTER



- application: for cutting wood and plastics
- przeznaczenie: do cięcia drewna, płyt drewnopochodnych, tworzyw sztucznych



YATO	Ø (mm)	Ø (mm)	R.P.M.max.	D (mm)	thickness of blade / grubość ostrza	T	Box
YT-6050	130	16.0	10000	2.8	2.0	24	25/50
YT-6052	140	20.0	10000	2.8	2.0	16	25/50
YT-6053	140	16.0	10000	2.8	2.0	30	25/50
YT-6055	160	20.0	9500	2.8	2.0	18	25/50
YT-6056	160	30.0	9500	2.8	2.0	24	25/50
YT-6057	160	30.0	9500	2.8	2.0	36	25/50
YT-6058	160	20.0	9500	2.8	2.0	48	25/50
YT-6060	184	30.0	9000	3.2	2.2	24	25/50
YT-6061	184	30.0	9000	3.2	2.2	40	25/50
YT-6062	184	30.0	9000	3.2	2.2	50	25/50
YT-6063	185	20.0	9000	2.4	1.4	18	25/50
YT-6065	200	30.0	8000	3.2	2.2	24	10/20
YT-6066	205	18.0	6000	3.2	2.0	24	10/20
YT-6067	210	30.0	8000	3.2	2.2	40	10/20

YATO	Ø (mm)	Ø (mm)	R.P.M.max.	D (mm)	thickness of blade / grubość ostrza	T	Box
YT-6068	210	30.0	8000	3.2	2.2	60	10/20
YT-6070	250	30.0	6000	3.2	2.2	24	10/20
YT-6071	250	30.0	6000	3.2	2.2	40	10/20
YT-6072	250	30.0	6000	3.2	2.2	60	10/20
YT-6075	300	30.0	6000	3.2	2.2	24	10
YT-6076	300	30.0	5000	3.2	2.2	40	10
YT-6077	300	30.0	5000	3.2	2.2	60	10
YT-6078	300	30.0	5000	3.2	2.2	96	10
YT-6080	350	30.0	4500	3.5	2.5	28	10
YT-6081	350	30.0	4500	3.5	2.5	40	10
YT-6082	350	30.0	4500	3.5	2.5	54	10
YT-6083	350	30.0	4500	3.5	2.5	84	10
YT-6085	400	30.0	4000	3.8	2.8	32	10
YT-6086	400	30.0	4000	3.8	2.8	60	10

GB TCT circular saw blade for aluminium  
D Hartmetallbestückt Kreissägeblatt für Aluminium  
PL Piła tarczowa do aluminium z węglikiem wolframu  
RUS Диск пильный по алюминию

CZ Kotoučová pila na hliník s karbidem wolframu  
H Wolframkarbidos körfűrészlap, alumíniumhoz  
RO Disc circular pt. aluminiu  
F Lame de scie circulaire pour aluminium

I Lama troncatrice alluminio  
E Disco de sierra con carbono  
CN 锯片

DOUBLE BLISTER

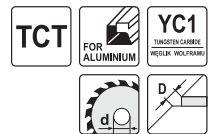

- application: for cutting aluminium profiles, laminates, plexi, corian and other plastics
- negati e angle of teeth
- przeznaczenie: do cięcia profili aluminiowych, laminatów, plexi, korianu, tworzyw sztucznych
- negatywny kąt natarcia zębów



YATO	Ø (mm)	Ø (mm)	R.P.M.max.	D (mm)	thickness of blade / grubość ostrza	T	Box
YT-6091	200	30	8000	3.0	2.2	60	10/20
YT-6093	210	30	8000	3.0	2.2	72	10/20
YT-6095	250	30	6000	3.0	2.2	100	10/20

YATO	Ø (mm)	Ø (mm)	R.P.M.max.	D (mm)	thickness of blade / grubość ostrza	T	Box
YT-6097	300	30	5000	3.0	2.2	100	10
YT-6099	350	30	4500	3.2	2.5	100	10

GB Metal cutting disc  
D Trennscheibe für Metall  
PL Tarcza do cięcia metalu

RUS Диск отрезной по металлу  
CZ Kotouč pro řezání kovů  
H Vágókorong fémhez

RO Disc debitat metal  
F Lame de scie pour métaux  
I Disco per taglio metallo

E Disco cortador para metal  
CN 锯片

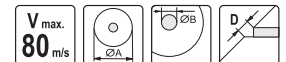

**INOX**

**INOX**

- depressed center
- wypukła

YATO	ØA (mm)	ØB (mm)	D (mm)	R.P.M.max.	PCS packing	Box
YT-6101	115	22	1.2	13200	5	25/200
YT-6102	115	22	2.5	13200	5	25/200
YT-6103	125	22	1.2	12200	5	25/200
YT-6104	125	22	2.5	12200	5	25/200
YT-6105	180	22	1.5	8600	5	25/50
YT-6106	180	22	2.5	8600	5	25/100
YT-6107	230	22	2.0	6500	5	25/50
YT-6108	230	22	3.2	6500	5	25/50

YATO	ØA (mm)	ØB (mm)	D (mm)	R.P.M.max.	PCS packing	Box
YT-5940	115	22	2.5	13200	5	25/200
YT-5942	125	22	2.5	12200	5	25/200
YT-5944	180	22	3.2	8600	5	25/50
YT-5945	230	22	3.2	6500	5	25/50

YATO	ØA (mm)	ØB (mm)	D (mm)	R.P.M.max.	PCS packing	Box
YT-5920	115	22	1.2	13200	5	25/200
YT-5921	115	22	2.5	13200	5	25/200
YT-5922	115	22	3.2	13200	5	25/200
YT-5923	125	22	1.2	12200	5	25/200
YT-5924	125	22	2.5	12200	5	25/200
YT-6110	125	22	3.2	12200	5	25/200
YT-5925	180	22	1.5	8600	5	25/50
YT-5926	180	22	2.5	8600	5	25/50
YT-6111	180	22	3.2	8600	5	25/100
YT-5927	230	22	2.0	6500	5	25/50
YT-6112	230	22	3.2	6500	5	25/50
YT-6113	300	32	3.2	5100	5	25
YT-6122	305	22	3.5	5100	5	10/20
YT-6136	350	32	3.5	4400	5	25
YT-6137	400	32	4.0	3800	5	25

GB Metal cutting disc  
 D Trennscheibe für Metall  
 PL Tarcza do cięcia metalu  
 RUS Диск отрезной по металлу  
 CZ Kotouč pro řezání kovu  
 H Vágókorong fémhez  
 RO Disc debitat metale  
 F Lame de scie pour métaux  
 I Disco per taglio metallo  
 E Disco cortador para metalo  
 CN 锯片

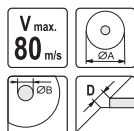

GB Metal grinding disc  
 D Me a -Sch eifscheibe  
 PL Tarcza do szlifowania metalu  
 RUS Круги для шлифования по металлу  
 CZ Kotouč pro broušení kovu  
 H Vágókorong fémhez

RO Disc pt. șlefuit metal  
 F Disque de polissage pour métaux  
 I Disco per rettifica metallo  
 E Disco cortador para metalo  
 CN 锯片

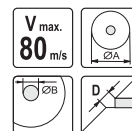

10

• depressed center • wypukła

YATO	∅A (mm)	∅B (mm)	D (mm)	∅ R.P.M.max.	PCS packing	Box
YT-6114	115	22	2.5	13200	5	25/200
YT-6115	115	22	3.2	13200	5	25/200
YT-6116	125	22	2.5	12200	5	25/200
YT-6117	125	22	3.2	12200	5	25/200
YT-6119	180	22	3.2	8600	5	25/100
YT-6120	230	22	3.2	6500	5	25/50

• depressed center • wypukła

YATO	∅A (mm)	∅B (mm)	D (mm)	∅ R.P.M.max.	PCS packing	Box
YT-6121	115	22	6.0	13200	5	25/100
YT-6123	115	22	8.0	13200	5	25/100
YT-6124	125	22	6.0	12200	5	30/120
YT-6126	125	22	8.0	12200	5	25/100
YT-6138	180	22	6.8	8600	5	15/30
YT-6125	230	22	6.0	6500	5	5/30

**INOX**

• depressed center • wypukła

YATO	∅A (mm)	∅B (mm)	D (mm)	∅ R.P.M.max.	PCS packing	Box
YT-5946	115	22	6.0	13200	5	25/100
YT-5947	125	22	6.8	12200	5	25/100
YT-5948	180	22	6.8	8600	5	15/30
YT-5949	230	22	6.8	6500	5	15/30

GB Stone cutting disc  
 D Trennscheibe für Stein  
 PL Tarcza do cięcia kamienia  
 RUS Диск отрезной по камню  
 CZ Kotouč pro řezání kamene  
 H Vágókorong kőhöz

RO Disc pt. tăiat piatră  
 F Disque de coupe pour granit  
 I Disco per taglio pietra  
 E Disco cor ador de iedra  
 CN 石材锯片

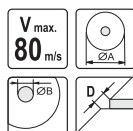

GB Stone grinding disc  
 D S ein-sch eifscheibe  
 PL Tarcza do szlifowania kamienia  
 RUS Диск для шлифования по камню  
 CZ Kotouč pro broušení kamene  
 H Csiszolókorong kőhöz  
 RO Disc pt. șlefuit piatră  
 F Disque de polissage pour granit  
 I Disco per rettifica pietra  
 E Disco cor ador de iedra  
 CN 锯片

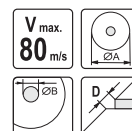

• depressed center • wypukła

YATO	∅A (mm)	∅B (mm)	D (mm)	∅ R.P.M.max.	PCS packing	Box
YT-5930	115	22	1.5	13200	5	25/200
YT-5932	125	22	1.5	12200	5	25/200
YT-5933	125	22	3.2	12200	5	25/200
YT-5934	180	22	3.2	8600	5	25/50
YT-5935	230	22	3.2	6500	5	25/50

YATO	∅A (mm)	∅B (mm)	D (mm)	∅ R.P.M.max.	PCS packing	Box
YT-6128	115	22	3.2	13200	5	25/200
YT-6129	125	22	3.2	12200	5	25/200
YT-6130	180	22	3.2	8600	5	25/100
YT-6131	230	22	3.2	6500	5	25/50

• depressed center • wypukła

YATO	∅A (mm)	∅B (mm)	D (mm)	∅ R.P.M.max.	PCS packing	Box
YT-6132	115	22	6.0	13200	5	25/100
YT-6133	125	22	6.8	12200	5	25/100
YT-6134	180	22	6.8	8600	5	15/30
YT-6135	230	22	6.8	6500	5	15/30

GB Cable cutter  
D Kabe schere  
PL Szczypce do cięcia przewodów  
RUS Кабелерезы  
CZ Elektrické upichováky  
H Kábelvágó  
RO Patent tăietor pt. electrice  
F Pince à couper les fils  
I Pinze per tagliare i cavi  
E Teras ara cab es  
CN 电缆剪



SLIDING CARD

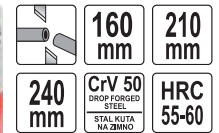

YATO	L (mm)	max. Ø (mm)	
YT-1966	160	6	6/60
YT-1967	210	7	6/60
YT-1968	240	8	6/48

• application: for copper and aluminium electric cables

• przeznaczenie: do cięcia miedzianych i aluminiowych kabli

GB Heavy duty cable cutter  
D Schwere Drahschere  
PL Wzmocnione nożyce do cięcia przewodów  
RUS Кабелерезы  
CZ Elektrické upichováky  
H Kábelvágó  
RO Patent tăietor pt. electrice  
F Pince renforcée à couper les fils  
I Pinze per tagliare i cavi  
E Teras ara cab es  
CN 电缆剪



SLIDING CARD



YATO	L (mm)	max. Ø (mm)	
YT-1969	240	9	6/48

• application: for copper and aluminium electric cables

• przeznaczenie: do cięcia miedzianych i aluminiowych kabli

GB Heavy duty cable cutter  
D Schwere Drahschere  
PL Wzmocnione nożyce do cięcia przewodów  
RUS Кабелерезы  
CZ Elektrické upichováky  
H Kábelvágó  
RO Patent tăietor pt. electrice  
F Pince renforcée à couper les fils  
I Pinze per tagliare i cavi  
E Teras ara cab es  
CN 电缆剪



SLIDING CARD

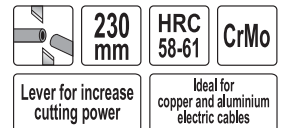

YATO	L (mm)	max. Ø (mm)	
YT-1933	230	9	6/36

GB Tin snips  
D B e chschere  
PL Nożyce do cięcia blachy  
RUS Ножницы по металлу  
CZ Nůžky na plech  
H Lemezvágó olló  
RO Foarfece pt. tablă  
F Cisai e à e  
I Cesioie per lamiere  
E Teras ara cha as  
CN 铁皮剪

SLIDING CARD



YATO	L (mm)	cutting engt (mm)	cutting capacities (mm)				
			co er	co d-ro ed s ee	hard s ee HRC35	s ain ess s ee 304	
YT-1963	200	40	1.5	1.0	0.6	0.6	6/36
YT-1964	250	60	1.8	1.2	0.8	0.8	6/24
YT-1965	300	75	2.0	1.4	0.8	0.8	6/12

GB Tin snips  
D B e chschere  
PL Nożyce do cięcia blachy  
RUS Ножницы по металлу  
CZ Nůžky na plech  
H Lemezvágó olló  
RO Foarfece pt. tablă  
F Cisai e à e  
I Cesioie per lamiere  
E Teras ara cha as  
CN 铁皮剪

SLIDING CARD



YATO	L (mm)	cutting engt (mm)	cutting capacities (mm)				
			co er	co d-ro ed s ee	hard s ee HRC35	s ain ess s ee 304	
YT-1970	260	42	2.0	1.4	1.0	1.0	6/36

GB Tin sni s  
D B echscher  
PL Nożyce do cięcia blachy  
RUS Ножницы по металлу  
CZ Nůžky na plech  
H Lemezvágó olló  
RO Foarfece pt. tablă  
F Cisai e à e  
I Cesioie per lamiere  
E Teras ara cha as  
CN 铁皮剪



SLIDING CARD

HRC 60-62  
DIN 6438  
CrMo

INCREASED CUTTING POWER  
ZWIĘKSZONA SIŁA CIĘCIA



LEFT CUT  
CIECIE LEWE

YATO	L (mm)	cutting engt (mm)	cutting capacities (mm)				6/36
			co er	co d-ro ed s ee	hard s ee HRC35	s ain ess s ee 304	
YT-1910	260	35	1.80	1.50	1.00	0.90	6/36



RIGHT CUT  
CIECIE PRAWA

YATO	L (mm)	cutting engt (mm)	cutting capacities (mm)				6/36
			co er	co d-ro ed s ee	hard s ee HRC35	s ain ess s ee 304	
YT-1911	260	35	1.80	1.50	1.00	0.90	6/36



STRAIGHT CUT  
CIECIE PROSTE

YATO	L (mm)	cutting engt (mm)	cutting capacities (mm)				6/36
			co er	co d-ro ed s ee	hard s ee HRC35	s ain ess s ee 304	
YT-1912	260	35	1.80	1.50	1.00	0.90	6/36



LEFT CUT  
CIECIE LEWE

YATO	L (mm)	cutting engt (mm)	cutting capacities (mm)				6/36
			co er	co d-ro ed s ee	hard s ee HRC35	s ain ess s ee 304	
YT-1915	235	30	1.50	1.20	1.00	0.70	6/36



RIGHT CUT  
CIECIE PRAWA

YATO	L (mm)	cutting engt (mm)	cutting capacities (mm)				6/36
			co er	co d-ro ed s ee	hard s ee HRC35	s ain ess s ee 304	
YT-1916	235	30	1.50	1.20	1.00	0.70	6/36



LEFT CUT  
CIECIE LEWE

YATO	L (mm)	cutting engt (mm)	cutting capacities (mm)				6/36
			co er	co d-ro ed s ee	hard s ee HRC35	s ain ess s ee 304	
YT-1918	260	32	1.80	1.50	1.00	0.90	6/36



RIGHT CUT  
CIECIE PRAWA

YATO	L (mm)	cutting engt (mm)	cutting capacities (mm)				6/36
			co er	co d-ro ed s ee	hard s ee HRC35	s ain ess s ee 304	
YT-1919	260	32	1.80	1.50	1.00	0.90	6/36



STRAIGHT CUT  
CIECIE PROSTE

YATO	L (mm)	cutting engt (mm)	cutting capacities (mm)				6/36
			co er	co d-ro ed s ee	hard s ee HRC35	s ain ess s ee 304	
YT-1922	290	75	1.10	0.94	0.70	0.53	6/36



STRAIGHT CUT  
CIECIE PROSTE

YATO	L (mm)	cutting engt (mm)	cutting capacities (mm)				6/36
			co er	co d-ro ed s ee	hard s ee HRC35	s ain ess s ee 304	
YT-1923	230	25	2.00	1.60	1.20	1.20	6/36

GB Tin sni s  
D B echscher  
PL Nożyce do cięcia blachy  
RUS Ножницы по металлу  
CZ Nůžky na plech  
H Lemezvágó olló

RO Foarfece pt. tablă  
F Cisai e à e  
I Cesioie per lamiere  
E Teras ara cha as  
CN 铁皮剪



SLIDING CARD

HRC 56-62  
CrMo

INCREASED CUTTING POWER  
ZWIĘKSZONA SIŁA CIĘCIA

SERRATED EDGES  
ZABRAWIANA KRAWĘDZ  
OSTRY

HIGH FREQUENCY HARDENING  
HARTOWANIE WYPULSOWE



LEFT CUT  
CIECIE LEWE

YATO	L (mm)	cutting engt (mm)	cutting capacities (mm)				6/36
			co er	co d-ro ed s ee	hard s ee HRC35	s ain ess s ee 304	
YT-1960	250	40	2.00	1.50	1.00	0.80	6/36



RIGHT CUT  
CIECIE PRAWA

YATO	L (mm)	cutting engt (mm)	cutting capacities (mm)				6/36
			co er	co d-ro ed s ee	hard s ee HRC35	s ain ess s ee 304	
YT-1961	250	40	2.00	1.50	1.00	0.80	6/36



STRAIGHT CUT  
CIECIE PROSTE

YATO	L (mm)	cutting engt (mm)	cutting capacities (mm)				6/36
			co er	co d-ro ed s ee	hard s ee HRC35	s ain ess s ee 304	
YT-1962	250	45	2.00	1.50	1.00	0.80	6/36

GB Tin snips  
D B echscherer  
PL Nożyce do cięcia blachy  
RUS Ножницы по металлу  
CZ Nůžky na plech  
H Lemezvágó olló

RO Foarfece pt. tablă  
F Cisai e à e  
I Cesioie per lamiera  
E Teras ara cha as  
CN 铁皮剪

SLIDING  
CARD



For cutting  
straight and  
tight curves  
left or right



**HRC  
58-60**



**HRC  
58-61**

YATO	L (mm)	cutting engt. (mm)	cutting capacities (mm)				box
			co er	co d-ro ed s ee	hard s ee HRC35	s ain ess s ee 304	
YT-1920	260	42	1.20	1.00	0.60	0.50	6/36

YATO	L (mm)	cutting engt. (mm)	cutting capacities (mm)				box
			co er	co d-ro ed s ee	hard s ee HRC35	s ain ess s ee 304	
YT-1924	254	52	0.94	0.78	0.60	0.45	6/36

GB Tin snips  
D B echscherer  
PL Nożyce do cięcia blachy  
RUS Ножницы по металлу  
CZ Nůžky na plech  
H Lemezvágó olló

RO Foarfece pt. tablă  
F Cisai e à e  
I Cesioie per lamiera  
E Teras ara cha as  
CN 铁皮剪

SLIDING  
CARD



**DROP FORGED  
KUTE**

**HRC  
58-61**



LEFT  
CUT  
CIĘCIE  
LEWE



RIGHT  
CUT  
CIĘCIE  
PRAWĘ

YATO	L (mm)	cutting engt. (mm)	cutting capacities (mm)				box
			co er	co d-ro ed s ee	hard s ee HRC35	s ain ess s ee 304	
YT-1900	260	30	0.94	0.78	0.60	0.45	6/24

YATO	L (mm)	cutting engt. (mm)	cutting capacities (mm)				box
			co er	co d-ro ed s ee	hard s ee HRC35	s ain ess s ee 304	
YT-1901	260	30	0.94	0.78	0.60	0.45	6/24



RIGHT  
CUT  
CIĘCIE  
PRAWĘ



STRAIGHT  
CUT  
CIĘCIE  
PROSTE

YATO	L (mm)	cutting engt. (mm)	cutting capacities (mm)				box
			co er	co d-ro ed s ee	hard s ee HRC35	s ain ess s ee 304	
YT-1902	300	50	0.94	0.78	0.60	0.45	6/24

YATO	L (mm)	cutting engt. (mm)	cutting capacities (mm)				box
			co er	co d-ro ed s ee	hard s ee HRC35	s ain ess s ee 304	
YT-1925	225	52	0.94	0.78	0.60	0.45	6/36

GB Tin snips  
D B echscherer  
PL Nożyce do cięcia blachy  
RUS Ножницы по металлу  
CZ Nůžky na plech  
H Lemezvágó olló

RO Foarfece pt. tablă  
F Cisai e à e  
I Cesioie per lamiera  
E Teras ara cha as  
CN 铁皮剪

SLIDING  
CARD



**HRC  
60-62**

**CrMo**

**90°**

SEPARATED  
EDGES  
ZABKOWANA  
KRAWĘDZ  
OSTRY



LEFT  
CUT  
CIĘCIE  
LEWE



RIGHT  
CUT  
CIĘCIE  
PRAWĘ

YATO	L (mm)	cutting engt. (mm)	cutting capacities (mm)				box
			co er	co d-ro ed s ee	hard s ee HRC35	s ain ess s ee 304	
YT-1913	225	30	0.78	0.53	0.46	0.36	6/36

YATO	L (mm)	cutting engt. (mm)	cutting capacities (mm)				box
			co er	co d-ro ed s ee	hard s ee HRC35	s ain ess s ee 304	
YT-1914	225	30	0.78	0.53	0.46	0.36	6/36

GB Por ab e no hers  
 D Schere zum Ausschneiden von Ecken  
 PL Nożyce do wycinania naroży  
 RUS Ножницы для наружных углов  
 CZ Nůžky na vystřihování rohů  
 H Sarokkivágó olló  
 RO Foarfeca pt. taierea colturilor

F Ciseaux pour le coupage des coins  
 I Cesioie per taglio reggetta in angoli  
 E Tijera para esquinas  
 CN 截角器

300 mm 90°

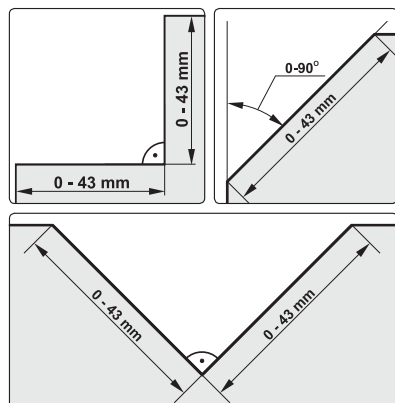

YATO	L (mm)	
YT-1939	300	15

GB Steel strap cutter  
 D Stahlgurtblechscherer  
 PL Nożyce do cięcia taśmy stalowej  
 RUS Ножницы для резки стальной ленты  
 CZ Nůžky na plech  
 H Lemezvágó olló  
 RO Foarfeca pt. tablă  
 F Cisai e à bande acier  
 I Cesioia per taglio reggetta in acciaio  
 E Tijeras ara bande as de acero  
 CN 钢带剪

HRC 58-61

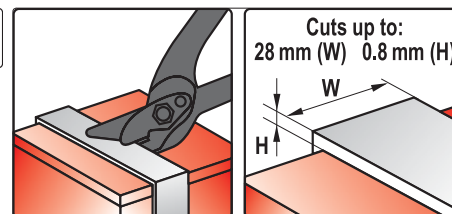

YATO	L (mm)	cutting engt (mm)	cutting capacities (mm)				
			co er	co d-ro ed see	hard see HRC35	stainless see 304	
YT-1930	305	28	-	1.00	0.80	0.60	6/24

GB Bolt cutter  
 D Drahschere  
 PL Nożyce do prętów  
 RUS Болторез  
 CZ Nůžky na tyče  
 H Kábelvágó olló  
 RO Foarfeca pt. bare

F Cisaille pour barres  
 I Cesioie taglia bulloni  
 E Cor avari as  
 CN 断线钳

HRC 56-61 CrMo



YATO	size / rozmiar	max. Ø (mm) soft / miękki	max. Ø (mm) medium / srednio twardy	
YT-1843	12" (300 mm)	5	4	20
YT-1844	14" (350 mm)	7	5	10
YT-1845	18" (450 mm)	8	6	10
YT-1846	24" (600 mm)	10	8	6
YT-1847	30" (750 mm)	13	10	4
YT-1848	36" (900 mm)	16	12	3

GB Bolt cutter  
 D Drahschere  
 PL Nożyce do prętów  
 RUS Болторез  
 CZ Nůžky na tyče  
 H Kábelvágó olló  
 RO Foarfeca pt. bare  
 F Cisaille pour barres  
 I Cesioie taglia bulloni  
 E Cor avari as  
 CN 断线钳

CrMo



YATO	size / rozmiar	max. Ø (mm)	
YT-1851	14" (350 mm)	6	6/24
YT-1852	18" (450 mm)	7	6/12
YT-1853	24" (600 mm)	10	2/12

YATO	size / rozmiar	max. Ø (mm)	
YT-1854	30" (750 mm)	12	6
YT-1855	36" (900 mm)	14	4
YT-1856	42" (1050 mm)	16	2



GB Hydraulic cutter  
D Manueller Hydraulikschneider  
PL Ręczny obcinak hydrauliczny  
RUS Ручной гидравлический резак  
CZ Rucní hydraulický odřezávac  
H Kézi hidraulikus betonacélvágó  
RO Cutit pt. retezat tevi  
F Coupe manuelle hydraulique  
I Cesola idraulica manuale  
E Cortadora hidráulica manual  
CN 液压剪



STEEL  
STAL

BMC  
& COLOR  
SLEEVE



YATO	cutting diameter / średnica cięcia (mm <sup>2</sup> )	L (mm)	pressure / nacisk (T)	
YT-22870	4-12	430	6	5
YT-22871	4-16	430	8	5
YT-22872	4-20	515	13	3

GB Heads for hydraulic cutter  
D Austauschmesser für Hydraulikschneider  
PL Noże wymienne do obcinaka hydraulicznego  
RUS Сменные ножи для гидравлического резака

CZ Vyměnitelné nože do hydraulického odřezávac  
H Cserekés a hidraulikus betonacélvágóhoz  
RO Lame schimbabile pt. cutit pt. retezat tevi  
F Lame pour coupe manuelle hydraulique

I Teste per coltelli idraulici  
E Cuchillas intercambiables para cortadora hidráulica  
CN 液压钳钳口配件

2  
PCS



SLIDING  
CARD



YATO	for / dla	size / rozmiar (mm)	
YT-22873	YT-22870	12	10/100
YT-22874	YT-22871	16	10/100
YT-22875	YT-22872	20	10/100

GB Ratchet cable cutter  
D Ra schenkabe schneider  
PL Nożyce zapadkowe do kabli  
RUS Кабелерез секторный

CZ Kleště na kabely, rohatka se západkou  
H Racsnis kábelvágó  
RO Cleste pt. taiat cablu cu clichet

F Cisailles à câbles  
I Cricchetto taglia cavo  
E Cor acab es de carraca  
CN 棘轮电缆剪

COLOR BOX



Cu/Al  
CABLE  
KABEL

60Si2Mn

HRC 50  
CUTTING BLADE  
OSTRZE TNĄCE

10



YATO	cutting range / max. przekrój cięcia (mm <sup>2</sup> )	L (mm)	
YT-18600	240	300	10

YATO	cutting range / max. przekrój cięcia (mm <sup>2</sup> )	L (mm)	
YT-18602	380	380	10

GB Cable cutter  
D Kabe schere  
PL Nożyce do kabli  
RUS Кабелерезы  
CZ ek rick upichováky  
H Kábelvágó  
RO Patent tăietor pt. electrice  
F Cisailles à câbles  
I Cesole er cavi  
E Tijeras ara cab es  
CN 电缆剪



COLOR BOX



STEEL  
STAL

YATO	cutting range / max. przekrój cięcia (mm <sup>2</sup> )	L (mm)	
YT-18610	125	370	20
YT-18611	250	580	10
YT-18612	500	770	5

GB Multi function scissors  
D Multifunktionsmesser  
PL Nożyce wielofunkcyjne  
RUS Ножницы многофункциональные  
CZ Viceúčelové nůžky  
H Többfunkciós olló  
RO Foarfece multifuncțional  
F Cisailles universelle  
I Cesole multifunzione  
E Tijeras multifuncionales  
CN 多用剪



65  
mm

3Cr13  
STAINLESS  
STEEL  
STAL  
NIERÓŻEŻYWA

HRC  
50-54

SLIDING  
CARD



YATO	L (mm)	
YT-1976	65	12/72

GB Hand saw for wood  
D Handsäge  
PL Pila płatnica do drewna  
RUS Пила по дереву  
CZ Pila na dřevu platnice  
H Fafűrész, egyenes  
RO Ferăstrău pt. lemn  
F Scie  
I Seghetto per legno  
E Serrucho para madera  
CN 手板锯



COLOR SLEEVE

Mn 65  
7T  
inch  
1.6 mm  
0.9 mm  
HRC 50-54

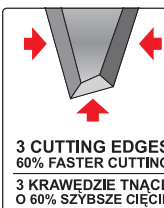

GB Back saw  
D Rücksäge  
PL Pila grzbietnica  
RUS Пила для стула  
CZ Pila hřebenovka  
H Kézifűrész  
RO Ferăstrău coadă de vulpe  
F Scie  
I Segha con dorso  
E Serrucho de costilla  
CN 夹背锯

300 mm  
Mn 65  
12T  
inch  
1.2 mm  
0.8 mm  
HRC 50-54



COLOR SLEEVE



YATO	L (mm)	
YT-3130	300	12/60



YATO	L (mm)	
YT-3101	400	12/48
YT-3102	450	10/40
YT-3103	500	10/40



PTFE  
COATED

YATO	L (mm)	
YT-3106	400	12/48
YT-3107	450	10/40
YT-3108	500	10/40

GB Compass saw  
D Stichsäge  
PL Pila otwornica  
RUS Выкружная пила  
CZ Pila o vornice  
H Lyukfűrész  
RO Ferăstrău coadă de șoarece

F Scie roi e  
I Segha a foretto  
E Serrucho de punta  
CN 鸡尾锯

300 mm  
Mn 65  
7T  
inch  
1.6 mm  
0.9 mm  
HRC 50-54



COLOR SLEEVE

YATO	L (mm)	
YT-3133	300	12/60

GB a board saw  
D Gipsäge  
PL Pila do gipsów  
RUS Ножовка по гипсокартону  
CZ Pila na sádru  
H Gipszfűrész

RO Ferăstrău pt. ghips  
F Scie pour plaques de plâtre  
I Segha per cartongesso  
E Serrucho para cartón yeso  
CN 墙板锯

150 mm  
Mn 65  
7T  
inch  
2.0 mm  
1.5 mm  
HRC 50-54



COLOR SLEEVE

YATO	L (mm)	
YT-3134	150	12/60

GB Plastic mitre box with dovetail saw  
D Kunststoffschneidladen mit Säge  
PL Plastikowa skrzynka uciosowa z pilą  
RUS Стуло пластмассовое с пилой  
CZ Přípravek na řezání úhlů s pilkou  
H Gërbavóg múanyagláda hód farkú fűrészszel  
RO Pasuitor + cutie  
F Boîte à onglets + scie  
I Taglia cornici in plastica con sega  
E Guía de ingletar y sierra  
CN 燕尾锯

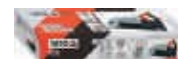

COLOR BOX

350 mm  
Mn 65  
12T  
inch  
1.2 mm  
0.8 mm  
HRC 50-54

ABS

300x140 x70mm



YATO	L (mm)	
YT-3150	350	10

GB Bow saw  
D Bùgelsäge  
PL Pila kabląkowa  
RUS Лучковая пила  
CZ Oblouková pila  
H Keretes fűrész

RO Ferăstrău de curbură  
F Scie à b ches  
I Segha ad arco  
E Sierra de arco  
CN 两用弓锯

COLOR SLEEVE



HCS 65



FOR WOOD  
DO DREWNA

2  
FUNCTION

FOR WOOD AND METAL  
DO DREWNA I METALU

YATO	L (mm)	
YT-3200	300	12/24

YATO	L (mm)	
YT-3201	450	12/24
YT-3202	530	
YT-3203	610	
YT-3204	760	

GB Blade for dry wood  
D Trockenholzsägeblatt für Handsäge  
PL Brzeczot do drewna suchego  
RUS Лезвие для работы по сухому дереву  
CZ Pilový list na suché dřevo

H Fűrészlap száraz fához  
RO Lama pt. lemn uscat  
F lame à bois sec  
I Lama per il legno secco  
E Hoja de sierra para madera seca  
CN 干木锯条

HCS  
65

DRY  
WOOD  
DREWNO  
SUCHE



COLOR SLEEVE

YATO	L (mm)	
YT-3221	450	50/200
YT-3222	530	
YT-3223	610	
YT-3224	760	

GB Blade for wet wood  
D Nassholzsägeblatt für Handsäge  
PL Brzeczot do drewna mokrego  
RUS Лезвие для работы по влажному дереву  
CZ Pilový list na mokré dřevo

H Fűrészlap nedves fához  
RO Lama pt. lemn verde  
F lame à bois humide  
I Lama per il legno bagnato  
E Hoja de sierra para madera mojada  
CN 湿木锯条

HCS  
65

WET  
WOOD  
DREWNO  
MOKRE



COLOR SLEEVE

YATO	L (mm)	
YT-3230	300	50/200
YT-3231	450	
YT-3232	530	
YT-3233	610	
YT-3234	760	

GB Hacksaw frame  
D Metallbogensäge  
PL Piła do metalu  
RUS Пила по металлу  
CZ Pílka na železo  
H Fémfűrész

RO Ferăstrău cu cadru metalic  
F Scie à métal  
I Seghetto per metallo  
E Sierra de metalo  
CN 锯架

COLOR  
SLEEVE



BI-METAL

24  
TPI

FOR  
METAL  
DO  
METALU



YATO	L (mm)	
YT-3160	300	10



YATO	L (mm)	
YT-3161	300	6/36



YATO	L (mm)	
YT-3163	300	5/20

GB Hacksaw frame blade  
D Metallsägeblatt  
PL Brzeczot do metalu

RUS Полотно по металлу  
CZ Pilový list na kov  
H Fémfűrész lap

RO Panza fierastrau pt. metal  
F lame à métal  
I Lama per metallo

E Hoja de sierra para metalo  
CN 锯条

300  
mm

12  
mm

24  
TPI



PLASTIC  
HANGER



BI-METAL  
M2+6150

BI-METAL  
M2+Co8%

YATO	L (mm)	(mm)	T	PCS packing:	
YT-3460	300	12	24	5	10/200

YATO	L (mm)	(mm)	T	PCS packing:	
YT-3461	300	12	24	2	20/500

YATO	L (mm)	(mm)	T	PCS packing:	
YT-3462	300	12	24	2	20/500

GB Jig saw blades  
D Stichsägeblätter  
PL Brzeszco do w rz narki  
RUS Полотно для электр. станка

CZ Pilový list do přímočaré pily  
H Deko ra  
RO Lama fierastrau pendular  
F Lames à scie sauteuse

I Scalpelli per il seghetto  
E Recambio sierra de calar  
CN 曲线锯条



5  
PCS



YATO	L (mm)	work ing engt (mm)	thickness (mm)	T	
YT-3400	100	75	1.27	6	50/250

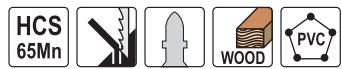

YATO	L (mm)	work ing engt (mm)	thickness (mm)	T	
YT-3401	100	75	1.3	10	50/250



YATO	L (mm)	work ing engt (mm)	thickness (mm)	T	
YT-3402	100	75	1.2	8	50/250



YATO	L (mm)	work ing engt (mm)	thickness (mm)	T	
YT-3403	100	75	1.3	6	50/250



YATO	L (mm)	work ing engt (mm)	thickness (mm)	T	
YT-3404	100	75	1.3	10	50/250



YATO	L (mm)	work ing engt (mm)	thickness (mm)	T	
YT-3405	100	75	1.3	6	50/250



YATO	L (mm)	work ing engt (mm)	thickness (mm)	T	
YT-3407	75	50	1.0	13	50/250



YATO	L (mm)	work ing engt (mm)	thickness (mm)	T	
YT-3408	115	90	1.3	13-8	50/250



YATO	L (mm)	work ing engt (mm)	thickness (mm)	T	
YT-3409	115	90	1.3	8	50/250



YATO	L (mm)	work ing engt (mm)	thickness (mm)	T	
YT-3410	100	75	1.4	6	50/250

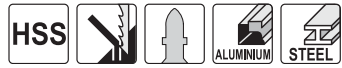

YATO	L (mm)	work ing engt (mm)	thickness (mm)	T	
YT-3411	100	75	1.0	8	25/250



YATO	L (mm)	work ing engt (mm)	thickness (mm)	T	
YT-3412	75	50	1.0	21	25/250



YATO	L (mm)	work ing engt (mm)	thickness (mm)	T	
YT-3413	75	50	1.0	12	25/250



YATO	L (mm)	work ing engt (mm)	thickness (mm)	T	
YT-3414	75	50	1.0	32	25/250



YATO	L (mm)	work ing engt (mm)	thickness (mm)	T	
YT-3415	100	75	1.0	24-10	25/250



YATO	L (mm)	work ing engt (mm)	thickness (mm)	T	
YT-3416	130	106	1.0	21	25/250



YATO	L (mm)	work ing engt (mm)	thickness (mm)	T	
YT-3417	130	106	1.27	10-5	25/250

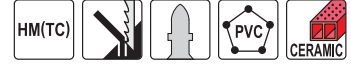

YATO	L (mm)	work ing engt (mm)	thickness (mm)	T	
YT-3421	75	50	1.2	-	25/250

GB Jig saw blades CZ Pilový list do přímočaré pily I Scalpelli per il seghetto  
 D Stichsägeblätter H Deko ra E Recambio sierra de calar  
 PL Brzeszczo do w rz narki RO Lama fierastrau pendular CN 曲线锯条  
 RUS Полотно для электр. станка F Lames à scie sauteuse

BLISTER  
CARD



5  
PCS



YATO	L (mm)	working ength (mm)	thickness (mm)	T	Box
YT-3430	91.5	74.5	1.3	10	25/250



YATO	L (mm)	working ength (mm)	thickness (mm)	T	Box
YT-3431	91.5	74.5	1.2	8	25/250



YATO	L (mm)	working ength (mm)	thickness (mm)	T	Box
YT-3432	91.5	74.5	1.3	6	25/250



YATO	L (mm)	working ength (mm)	thickness (mm)	T	Box
YT-3433	91.5	74.5	1.3	10	25/250



YATO	L (mm)	working ength (mm)	thickness (mm)	T	Box
YT-3434	108	91	1.3	12-8	25/250



YATO	L (mm)	working ength (mm)	thickness (mm)	T	Box
YT-3435	100	83	1.27	6	25/250



YATO	L (mm)	working ength (mm)	thickness (mm)	T	Box
YT-3440	70	53	1.0	21	25/250



YATO	L (mm)	working ength (mm)	thickness (mm)	T	Box
YT-3441	70	53	1.0	12	25/250



YATO	L (mm)	working ength (mm)	thickness (mm)	T	Box
YT-3442	70	53	1.0	36	25/250



YATO	L (mm)	working ength (mm)	thickness (mm)	T	Box
YT-3443	91.5	74.5	1.0	21-16	25/250



YATO	L (mm)	working ength (mm)	thickness (mm)	T	Box
YT-3444	127	110	1.2	10-5	25/250

GB Jig saw blades CZ Pilový list do přímočaré pily I Scalpelli per il seghetto  
 D Stichsägeblätter H Deko ra E Recambio sierra de calar  
 PL Brzeszczo do w rz narki RO Lama fierastrau pendular CN 曲线锯条  
 RUS Полотно для электр. станка F Lames à scie sauteuse

BLISTER  
CARD



5  
PCS



YATO	L (mm)	working ength (mm)	thickness (mm)	T	Box
YT-3404	100	75	1.3	10	25/250
YT-3403	100	75	1.3	6	
YT-3445	100	75	1.27	10	
YT-3445	75	50	1.0	32	
YT-3445	75	57	1.0	12	



YATO	L (mm)	working ength (mm)	thickness (mm)	T	Box
YT-3403	100	75	1.3	10	25/250
YT-3403	100	75	1.3	6	
YT-3445	100	75	1.27	10	
YT-3445	75	50	1.0	32	
YT-3445	75	57	1.0	12	



YATO	L (mm)	working ength (mm)	thickness (mm)	T	Box
YT-3445	100	75	1.3	10	25/250
YT-3445	100	75	1.3	6	
YT-3445	100	75	1.27	10	
YT-3445	75	50	1.0	32	
YT-3445	75	57	1.0	12	



YATO	L (mm)	working ength (mm)	thickness (mm)	T	Box
YT-3414	100	75	1.3	10	25/250
YT-3414	100	75	1.3	6	
YT-3445	100	75	1.27	10	
YT-3445	75	50	1.0	32	
YT-3445	75	57	1.0	12	



YATO	L (mm)	working ength (mm)	thickness (mm)	T	Box
YT-3414	100	75	1.3	10	25/250
YT-3414	100	75	1.3	6	
YT-3445	100	75	1.27	10	
YT-3445	75	50	1.0	32	
YT-3445	75	57	1.0	12	

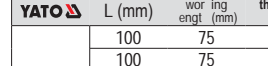

YATO	L (mm)	working ength (mm)	thickness (mm)	T	Box
YT-3445	100	75	1.3	10	25/250
YT-3445	100	75	1.3	6	
YT-3445	100	75	1.27	10	
YT-3445	75	50	1.0	32	
YT-3445	75	57	1.0	12	

GB Half-moon saw blade for oscillating multitool HSS  
 D Rundes Sägeblatt HSS für ein Multifunktionswerkzeug  
 PL Brzeszczot okrągły HSS do narzędzia wielofunkcyjnego  
 RUS Дисковое полотно HSS для многофункционального инструмента  
 CZ Segmentový pilový list HSS pro multifunkční nářadí  
 H HSS kör keresztmetszetű fűrészlap multifunkciós szerszámhoz  
 RO Lamă rotundă HSS pt. unealta multifuncțională  
 F lame segment HSS pour outil multifonction  
 I Lama di sega circolare per lo strumento multi-funzione HSS  
 E Ho a redonda HSS para herramienta multifuncional  
 CN 高速钢半圆形锯片

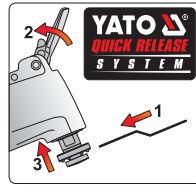

88 mm

HSS

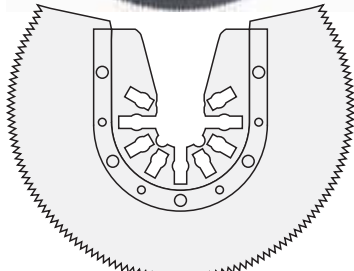

- application: wood, plastic, soft metal, plaster
- zastosowanie: drewno, plastik, miękki metal, gips

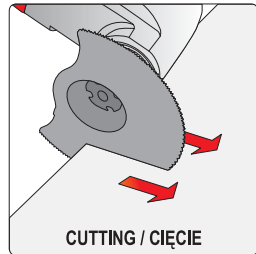

CUTTING / CIĘCIE

for / dla: YT-82220

DOUBLE BLISTER

YATO  
YT-34680

5/100

GB Half-moon saw blade for oscillating multitool HCS  
 D Rundes Sägeblatt HCS für ein Multifunktionswerkzeug  
 PL Brzeszczot okrągły HCS do narzędzia wielofunkcyjnego  
 RUS Дисковое полотно HCS для многофункционального инструмента  
 CZ Segmentový pilový list HCS pro multifunkční nářadí  
 H HCS kör keresztmetszetű fűrészlap multifunkciós szerszámhoz  
 RO Lamă rotundă HCS pt. unealta multifuncțională  
 F lame segment HCS pour outil multifonction  
 I Lama di sega circolare per lo strumento multi-funzione HCS  
 E Ho a redonda HCS para herramienta multifuncional  
 CN 高碳钢扇形锯片

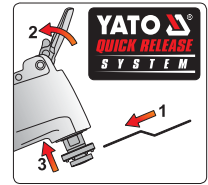

88 mm

HCS

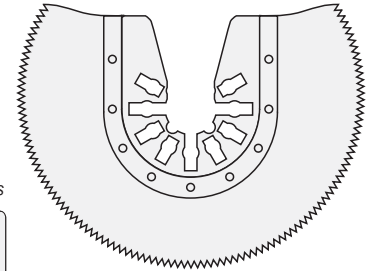

- application: wood, plastic, soft metal, plaster
- zastosowanie: drewno, plastik, miękki metal, gips

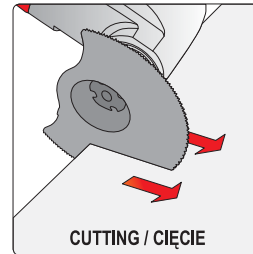

CUTTING / CIĘCIE

for / dla: YT-82220

DOUBLE BLISTER

YATO  
YT-34681

5/100

GB Brazed carbide d-shape blade for oscillating multitool HM  
 D Rundes Sägeblatt HM für ein Multifunktionswerkzeug  
 PL Brzeszczot okrągły HM do narzędzia wielofunkcyjnego  
 RUS Дисковое полотно HM для многофункционального инструмента  
 CZ Segmentový pilový list HM pro multifunkční nářadí  
 H HM kör keresztmetszetű fűrészlap multifunkciós szerszámhoz  
 RO Lamă rotundă HM pt. unealta multifuncțională  
 F lame segment HM pour outil multifonction  
 I Lama di sega circolare per lo strumento multi-funzione HM  
 E Ho a redonda HM para herramienta multifuncional  
 CN D形合金磨片



70 mm

HM

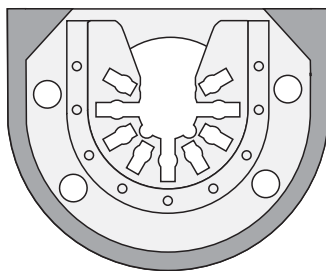

- application: concrete, ceramic materials, epoxy resin, fibreglass
- zastosowanie: beton, materiały ceramiczne, żywica epoksydowa, włókno szklane

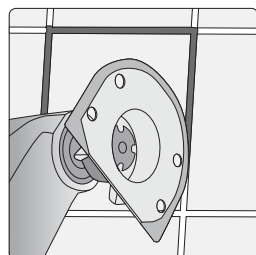

for / dla: YT-82220

DOUBLE BLISTER

YATO  
YT-34682

5/100

GB Plunge cutting saw blade for oscillating multitool BIM  
 D Tiefenmesser BIM für ein Multifunktionswerkzeug  
 PL Brzeszczot wgłębny BIM do narzędzia wielofunkcyjnego  
 RUS Сабельное полотно BIM для многофункционального инструмента  
 CZ Pilový list BIM na ponorné řezy pro multifunkční nářadí  
 H BIM merülő fűrészlap multifunkciós szerszámhoz  
 RO Lamă de adâncime BIM pt. unealta multifuncțională  
 F lame scie plongeante BIM pour outil multifonction  
 I Lama per tagli dal pieno BIM  
 E Hoja para cortes profundos BIM para herramienta multifuncional  
 CN 双金属直锯片

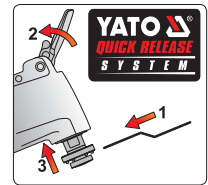

10 mm

BIM

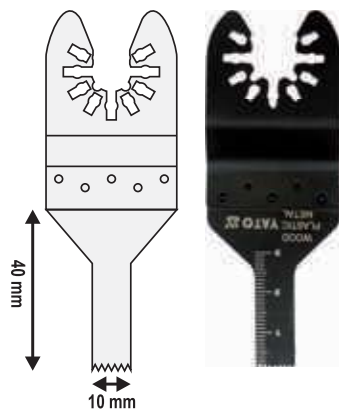

- application: wood, plastic, metal, plaster, epoxy resin
- zastosowanie: drewno, plastik, metal, gips, żywica epoksydowa

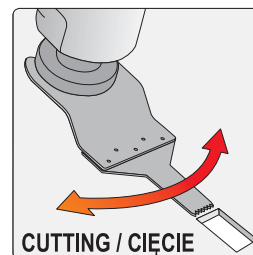

CUTTING / CIĘCIE

for / dla: YT-82220

DOUBLE BLISTER

YATO  
YT-34683

5/100

GB Plunge cutting saw blade for oscillating multitool BIM  
D Tiefenmesser BIM für ein Multifunktionswerkzeug  
PL Brzeszczot wgłębny BIM do narzędzia wielofunkcyjnego  
RUS Сабельное полотно BIM  
для многофункционального инструмента  
CZ Pilový list BIM na ponorné řezy pro multifunkční nářadí  
H BIM merülő fűrészlap multifunkciós szerszámhoz  
RO Lamă de adâncime BIM pt. unealta multifuncțională  
F Lame scie plongeante BIM pour outil multifonction  
I Lama per tagli dal pieno BIM  
E Hoja para cortes profundos BIM  
para herramienta multifuncional  
CN 双金属直锯片

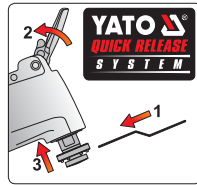

**3**  
PCS  
**28.5**  
mm  
**BIM**

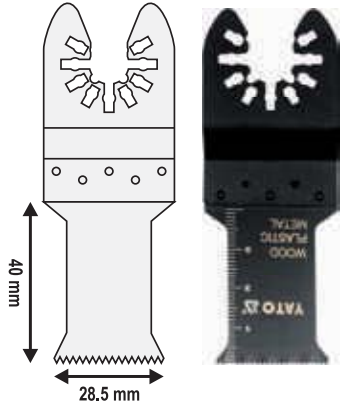

- application: wood, plastic, metal, plaster, epoxy resin
- zastosowanie: drewno, plastik, metal, gips, żywica epoksydowa

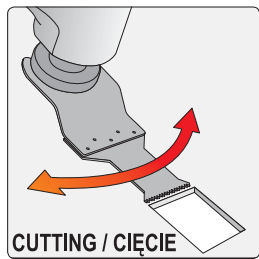

for / dla: YT-82220  
**YATO**  
YT-34684 5/100

**CUTTING / CIĘCIE**

GB Plunge cutting saw blade for oscillating multitool HCS  
D Tiefenmesser HCS für ein Multifunktionswerkzeug  
PL Brzeszczot wgłębny HCS do narzędzia wielofunkcyjnego  
RUS Сабельное полотно HCS  
для многофункционального инструмента  
CZ Pilový list HCS na ponorné řezy pro multifunkční nářadí  
H HCS merülő fűrészlap multifunkciós szerszámhoz  
RO Lamă de adâncime HCS pt. unealta multifuncțională  
F Lame scie plongeante HCS pour outil multifonction  
I Lama per tagli dal pieno HCS  
E Hoja para cortes profundos HCS  
para herramienta multifuncional  
CN 高碳钢直锯片

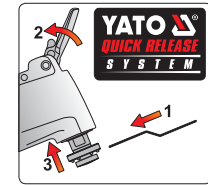

**3**  
PCS  
**34**  
mm  
**HCS**

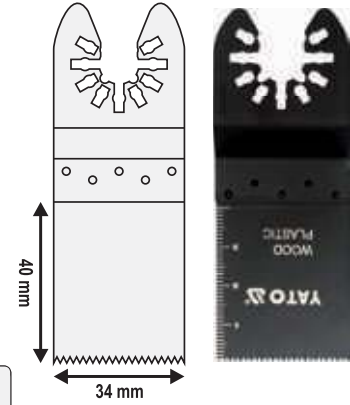

- application: wood, plastic, plaster
- zastosowanie: drewno, plastik, gips

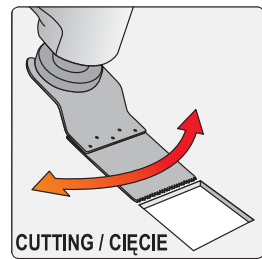

for / dla: YT-82220  
**YATO**  
YT-34685 5/100

**CUTTING / CIĘCIE**

GB Plunge cutting saw blade for oscillating multitool BIM  
D Tiefenmesser BIM für ein Multifunktionswerkzeug  
PL Brzeszczot wgłębny BIM do narzędzia wielofunkcyjnego  
RUS Сабельное полотно BIM  
для многофункционального инструмента  
CZ Pilový list BIM na ponorné řezy pro multifunkční nářadí  
H BIM merülő fűrészlap multifunkciós szerszámhoz  
RO Lamă de adâncime BIM pt. unealta multifuncțională  
F Lame scie plongeante BIM pour outil multifonction  
I Lama per tagli dal pieno BIM  
E Hoja para cortes profundos BIM  
para herramienta multifuncional  
CN 双金属直锯片

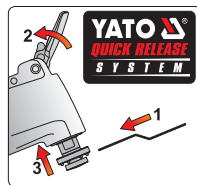

**20**  
mm  
**BIM**

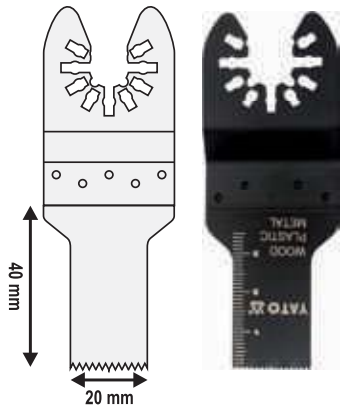

- application: wood, plastic, metal, plaster, epoxy resin
- zastosowanie: drewno, plastik, metal, gips, żywica epoksydowa



for / dla: YT-82220  
**YATO**  
YT-34686 5/100

**CUTTING / CIĘCIE**

GB Braze carbide triangular rasp for oscillating multitool  
D Dreieckige Raspel für ein Multifunktionswerkzeug  
PL Tarnik trójkątny do narzędzia wielofunkcyjnego  
RUS Треугольный рашпиль  
для многофункционального инструмента  
CZ Trojúhelníková brusná deska pro multifunkční nářadí  
H Háromszög keresztmetszetű reszelő multifunkciós szerszámhoz  
RO Raspel triunghiular pt. unealta multifuncțională  
F Plateau de ponçage à concretion carbure pour outil multifonction  
I Raspa in metallo duro forma triangolare multi-funzione  
E Escofina triangular para herramienta multifuncional  
CN 三角形嵌合金磨片

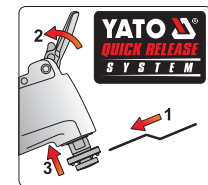

**80**  
mm  
**HM**

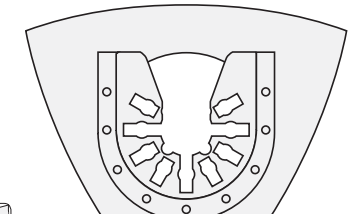

- application: concrete, ceramic materials
- zastosowanie: beton, materiały ceramiczne

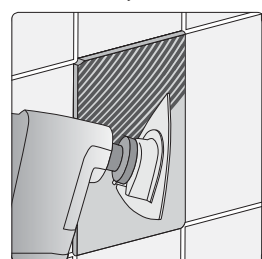

for / dla: YT-82220  
**YATO**  
YT-34687 5/100

**DOUBLE BLISTER**

GB Short scraper for oscillating multitool  
 D Schaber für ein Multifunktionswerkzeug  
 PL Skrobak do narzędzia wielofunkcyjnego  
 RUS Скребок для многофункционального инструмента  
 CZ Škrabka pro multifunkční nářadí  
 H Kaparó multifunkciós szerszámhoz  
 RO Răzuitor pt. unealta multifuncțională  
 F Spatule pour outil multifonction  
 I Raschietto oscillante multifunzione adatto  
 E Raspador para herramienta multifuncional  
 CN 弯刮刀

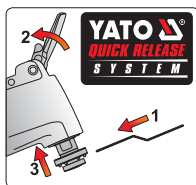

52 mm  
 HCS

• application:  
 paint, adhesi es,  
 sealing compounds

• zastosowanie:  
 farby, kleje, masy uszczelniające

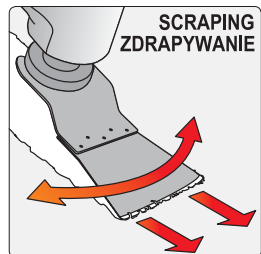

52 mm

for / dla: YT-82220

YATO  
 YT-34688

DOUBLE  
 BLISTER

5/100

GB Triangular eva sanding pad for oscillating multitool  
 D Schleiffluß für ein Multifunktionswerkzeug  
 PL Stopa szlifierska do narzędzia wielofunkcyjnego  
 RUS Шлифовальная насадка для многофункционального инструмента  
 CZ Brusný nástavec pro multifunkční nářadí  
 H Csiszoló talp multifunkciós szerszámhoz  
 RO Pciór de sablare pt. unealta multifuncțională  
 F Plateau de ponçage pour outil multifonction  
 I Tasso di smerigliatrice multifunzionale  
 E Pie de rectificación para herramienta multifuncional  
 CN 三角砂盘

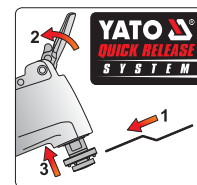

90 mm  
 EVA

• application:  
 wood, metal, plaster

• zastosowanie:  
 drewno, metal, gips

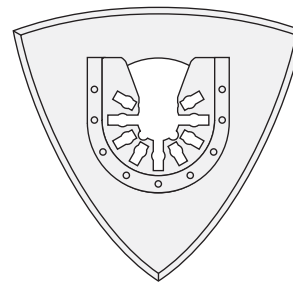
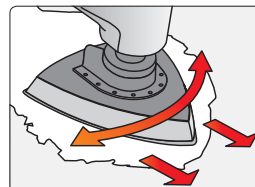

90 mm

for / dla: YT-82220

YATO  
 YT-34689

DOUBLE  
 BLISTER

5/100

GB Triangular sand paper for oscillating multitool  
 D Schleifpapier für ein Multifunktionswerkzeug  
 PL Papier ścierny do narzędzia wielofunkcyjnego  
 RUS Шлифовальная бумага для многофункционального инструмента  
 CZ Brusné plátno pro multifunkční nářadí  
 H Csiszolópapír multifunkciós szerszámhoz  
 RO Hârtie abrazivă pt. unealta multifuncțională  
 F Feuilles abrasives pour outil multifonction  
 I Carta abrasiva per utensile multifunzione  
 E Pa e de ia para herramienta multifuncional  
 CN 三角砂纸

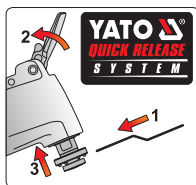

10 mm

• application:  
 wood, metal, plaster

• zastosowanie:  
 drewno, metal, gips

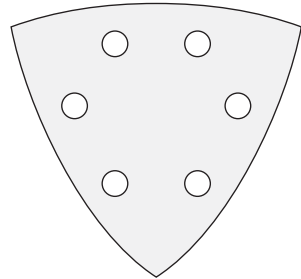
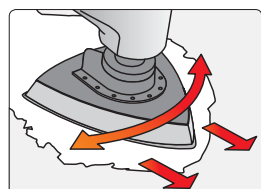

90 mm

for / dla: YT-82220

YATO  
 YT-34690

DOUBLE  
 BLISTER

5/100

GB Accessories set for oscillating multitool  
 D Zubehörsatz für ein Multifunktionswerkzeug  
 PL Zestaw akcesoriów do narzędzia wielofunkcyjnego  
 RUS Набор принадлежностей для многофункционального инструмента  
 CZ Souprava příslušenství pro multifunkční nářadí  
 H Tartozék szett multifunkciós szerszámhoz  
 RO Set de accesorii pt. unealta multifuncțională  
 F Set d'accessoires pour outil multifonction  
 I Set di accessori per utensile multifunzione  
 E Juego de accesorios para herramienta multifuncional  
 CN 三件套：双金属直锯片 + 高碳钢直锯片 + 高速钢半圆形锯片

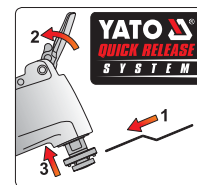

3 PCS  
 HSS  
 HCS  
 BIM

• application:  
 wood, plastic,  
 metal, plaster,  
 epoxy resin

• zastosowanie:  
 drewno, plastik,  
 metal, gips,  
 żywica epoksydowa

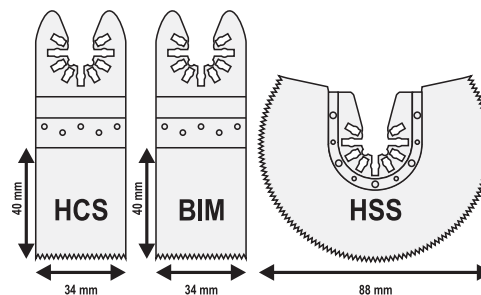
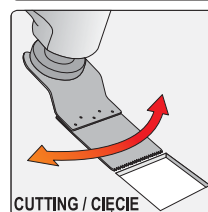
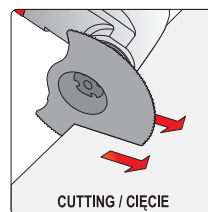

for / dla: YT-82220

YATO  
 YT-34691

DOUBLE  
 BLISTER



5/100





GB Steel wire brush CZ Drátěný kartáč F Brosse de fil en laiton E Ce i o de acero  
D Stahldrahtbürste H Dro kefe I Spazzola metallica CN 钢丝刷  
PL Szczotka druciana RO Perie de sârmă  
RUS Щетка стальная

ZINC  
PLATED  
WIRES



YATO 	rows / rzędy	
YT-6353	3	12/120
YT-6354	4	12/120
YT-6355	5	12/120
YT-6356	6	12/120

YATO 	rows / rzędy	
YT-6358	4	12/72
YT-6359	5	12/72
YT-6360	6	12/72

GB Steel wire brush CZ Drátěný kartáč F Brosse de fil en laiton E Ce i o de acero  
D Stahldrahtbürste H Dro kefe I Spazzola metallica CN 钢丝刷  
PL Szczotka druciana RO Perie de sârmă  
RUS Щетка стальная

TIED  
ON CARD



STEEL  
STAL

STEEL  
STAL



YATO 	rows / rzędy	L (mm)	
YT-6330	3	340	12/72

YATO 	rows / rzędy	L (mm)	
YT-6331	3	340	12/72



STEEL  
STAL

STEEL  
STAL

YATO 	rows / rzędy	L (mm)	
YT-6332	4	260	12/72

YATO 	rows / rzędy	L (mm)	
YT-6333	4	290	12/72



STEEL  
STAL

STAINLESS  
STEEL  
STAL  
NIEODZEWNA

YATO 	rows / rzędy	L (mm)	
YT-6334	6	180 65	12/60

YATO 	rows / rzędy	L (mm)	
YT-6335	3	340	12/72



STAINLESS  
STEEL  
STAL  
NIEODZEWNA

STAINLESS  
STEEL  
STAL  
NIEODZEWNA



YATO 	rows / rzędy	L (mm)	
YT-6336	3	340	12/72

YATO 	rows / rzędy	L (mm)	
YT-6337	3	180	24/144



STAINLESS  
STEEL  
STAL  
NIEODZEWNA

STAINLESS  
STEEL  
STAL  
NIEODZEWNA

YATO 	rows / rzędy	L (mm)	
YT-6338	4	260	12/72

YATO 	rows / rzędy	L (mm)	
YT-6339	4	290	12/72



STAINLESS  
STEEL  
STAL  
NIEODZEWNA

BRASS  
MOSIĄDZ

YATO 	rows / rzędy	L (mm)	
YT-6340	5	180	24/120

YATO 	rows / rzędy	L (mm)	
YT-6341	3	340	12/72

GB Steel wire brush CZ Drátěný kartáč F Brosse de fil en laiton E Cepillo de acero  
 D Stahldrahtbürste H Dró kefe I Spazzola metallica CN 钢丝刷  
 PL Szczotka druciana RO Perie de sármá  
 RUS Щетка стальная

BRASS  
MOSIÁDZ



YATO	rows / rzędy	L (mm)	
YT-6342	3	340	12/72

BRASS  
MOSIÁDZ



YATO	rows / rzędy	L (mm)	
YT-6343	3	180	24/144

TIED  
ON CARD

BRASS  
MOSIÁDZ



YATO	rows / rzędy	L (mm)	
YT-6344	4	260	12/72

BRASS  
MOSIÁDZ



YATO	rows / rzędy	L (mm)	
YT-6345	4	290	12/72

BRASS  
MOSIÁDZ



YATO	rows / rzędy	L (mm)	
YT-6346	5	180	24/120

BRASS  
MOSIÁDZ



YATO	rows / rzędy	L (mm)	
YT-6347	6	180 65	12/60

10

NYLON



YATO	rows / rzędy	L (mm)	
YT-6348	4	290	12/72

NYLON



YATO	rows / rzędy	L (mm)	
YT-6349	5	180	24/120

NYLON



YATO	rows / rzędy	L (mm)	
YT-6350	6	180 65	12/60

GB Plastic handle wire brush set I Set di s azzo e  
 D Bürstensatz metalliche  
 PL Komplet szczotek druczianych E Juego de 3 cepillos  
 RUS Щетки - набор CN 钢丝刷组套  
 CZ Drátěný kartáče  
 H Kefek sze  
 RO Perii  
 F Se de brosses  
 de fil en laiton

3  
PCS  
STAINLESS  
STEEL  
STAL  
NEROZEWNA  
BRASS  
MOSIÁDZ  
NYLON



SLIDING  
CARD

YATO	rows / rzędy	L (mm)	
YT-6351	3	180	24/144

GB Copper pipe internal brush RO Perii de interior pt. tevi de cupru  
 D Kupferrohr Innenbürste F Brosse aux tubes en cuivre  
 PL Szczotka wewnętrzna I Spazzola per il rame interno  
 do rur miedzianych E Cepillo para limpieza  
 RUS Щетка для внутренней очистки труб de tubos de cobre  
 CZ Kartáč vnitřní na měděné trubky CN 管子刷  
 H Rézcső belső tisztító kefe

STAINLESS  
STEEL  
WIRE  
DRUT ZE STALI  
NEROZEWNE



YATO	Ø (mm)	
YT-63701	15	12/120
YT-63702	18	12/120
YT-63703	22	12/120
YT-63704	28	12/120

GB Copper pipe brush 2 in 1 H Rézcső tisztító kefe 2 in 1  
 D 2-in-1 Kupferrohrbürste für Innen- RO Perii pt. tevi de cupru 2 in 1  
 und Außenreinigung F Brosse aux tubes en cuivre  
 PL Szczotka do rur miedzianych 2 w 1 I Spazzola per il tubi di rame 2 in 1  
 RUS Щетка для внутренней F 2-en-1 cepillo para limpieza  
 и внешней зачистки медных труб de tubos de cobre int. y ext  
 CZ Kartáč vnitřní a vnější E 2合1管子刷  
 na měděné trubky CN

STAINLESS  
STEEL  
WIRE  
DRUT ZE STALI  
NEROZEWNE



SLIDING  
CARD

YATO	Ø (mm)	
YT-63705	15 22	50/100

GB Cup brush with shaft RUS Щетка "чашка" со стержнем RO Perie frontală pt. bormasina E Cepillo de copa con mandril  
D Stahldraht-Topfbürste CZ Čelní kartáč drátěný se stopkou F Brosse coupe avec gouppille CN 钢丝轮  
PL Szczotka czolowa z trzpieniem H Homlok drótkefe, nyéllal I S azzo a a azza

SLIDING CARD



**INOX**

YATO	Ø (mm)	R.P.M.max.	Box
YT-4750	75	4500	12/96

YATO	Ø (mm)	R.P.M.max.	Box
YT-4751	75	4500	12/96

YATO	Ø (mm)	R.P.M.max.	Box
YT-4752	75	6000	12/72

GB Cup brush with shaft set RUS Щетки проволочные со стержнем  
D Drahtbürste mit Einspannschaft CZ Drátěný kartáč se stopkou  
PL Szczotki druciane z trzpieniem H Drótkefe, csapos  
RO Perie de sârmă cu tijă F Set de brosses coupe avec gouppille  
I Spazzola metallica a disco E Cepillos de alambre con espiga  
CN 三件钢丝组套



SLIDING CARD



YATO	Ø (mm)	R.P.M.max.	Box
YT-4755	20	6000	12/60
	50	7500	
	50	4500	

GB Circular brush with shaft RUS Щетка круговая со стержнем RO Perie rotundă pt. bormasina E Ce i o redondo  
D Stahldraht-Scheibenbürste CZ Okružní kartáč drátěný se stopkou F Brosse circulaire avec gouppille CN 钢丝轮  
PL Szczotka tarczowa z trzpieniem H Tarcás drótkefe, nyéllal I S azzo a a disco

SLIDING CARD



**INOX**

YATO	Ø (mm)	R.P.M.max.	Box
YT-4757	100	4500	12/96

YATO	Ø (mm)	R.P.M.max.	Box
YT-4758	100	4500	12/96

YATO	Ø (mm)	R.P.M.max.	Box
YT-4759	75	20000	10/100

GB Circular brush RUS Щетка круговая RO Perie rotundă pt. bormasina E Ce i o redondo  
D Stahldraht-Scheibenbürste CZ Okružní kartáč drátěný F Brosse circulaire avec filet CN 钢丝轮  
PL Szczotka tarczowa z gwintem H Tarcás drótkefe I S azzo a conica

COLOR BOX



**M14**



**INOX**

YATO	Ø (mm)	R.P.M.max.	Box
YT-4761	100	12500	8/64

YATO	Ø (mm)	R.P.M.max.	Box
YT-4763	100	12500	8/64

YATO	Ø (mm)	R.P.M.max.	Box
YT-4764	125	10000	8/48

GB Cup brush RUS Щетка "чашка" RO Perie frontală E Ce i o de co a  
D Stahldraht-Topfbürste CZ Čelní kartáč drátěný F Brosse coupe avec filet CN 钢丝轮  
PL Szczotka czolowa z gwintem H Homlok drótkefe I S azzo a conica

COLOR BOX



**M14**



**INOX**

YATO	Ø (mm)	R.P.M.max.	Box
YT-4766	100	8500	4/32

YATO	Ø (mm)	R.P.M.max.	Box
YT-4767	60	12500	10/80

YATO	Ø (mm)	R.P.M.max.	Box
YT-4768	75	11000	6/36

YATO	Ø (mm)	R.P.M.max.	Box
YT-4769	100	8500	4/16

GB ecran s knife CZ Montážní nůž I Co e o  
 D Montagemesser H Szerelőkés E Cuchillo de montaje  
 PL Nóż składany monterski RO Cuțit pt. decablat CN 电工刀  
 RUS Нож складной F Couteau d'électricien

SLIDING CARD



3CR13

HRC 42-48



85 mm 200 mm

75 mm 190 mm

<b>YATO</b>	
YT-7600	6/96

<b>YATO</b>	
YT-7601	6/96

GB Folding knife with bits H Zsebk s I Coltello pieghevole  
 D Klappmesser RO Briceag E Cuchillo con punte  
 PL Nóż składany z bitami F Couteau pince multifonction avec embouts E Nava a  
 RUS Нож складной CN 旋具头折叠刀  
 CZ Kapesní nůž

BLISTER CARD



STAINLESS STEEL STAL NERDZEWNIA



AI



3, 4 mm; 3, 4 mm; PH1, PH2; T10, T20

<b>YATO</b>	
YT-76031	4/40

10

GB Folding knife CZ Kapesní nůž I Co e o  
 D Klappmesser H Zsebk s I Co e o pieghevole  
 PL Nóż składany RO Briceag E Nava a  
 RUS Нож складной F Couteau pliant CN 折叠刀

SLIDING CARD



STAINLESS STEEL BLADE OSTRZE ZE STALI NERDZEWNEJ



AI

<b>YATO</b>	
YT-76050	12/72



<b>YATO</b>	
YT-76051	12/120



<b>YATO</b>	
YT-76052	12/120

GB Multi knife  
D Klappmesser  
PL Nóż  
wielofunkcyjny  
RUS Нож складной  
CZ Kapesní nůž  
H Zsebk s  
RO Briceag

F Couteau  
multifonction  
I Pinze universale  
E Nava a  
CN 多功能折叠刀

7  
PCS

STAINLESS  
STEEL  
STAL  
NERZEWIWA

AI



SLIDING  
CARD

**YATO**   
YT-76030

  
12/96

GB Multi knife  
D Klappmesser  
PL Narzędzie  
wielofunkcyjne  
RUS Нож складной

CZ Kapesní nůž  
H Zsebk s  
RO Briceag

I Pinze universale  
E Nava a  
CN 多功能折叠刀

F Couteau pince  
multifonction

BLISTER  
CARD



9  
PCS

STAINLESS  
STEEL  
STAL  
NERZEWIWA



AI

**YATO**   
YT-76040

  
10/100



AI

**YATO**   
YT-76041

  
12/48



AI

**YATO**   
YT-76042

  
12/48



**YATO**   
YT-76043

  
6/36

- GB Cutter knife  
 D Universalmesser  
 PL Nożyk z ostrzem trapezowym  
 RUS Ножи универсальные  
 CZ Univerzální nůž  
 H Univerzáls k s
- RO Cuțit universal  
 F Couteau lames trapésoïdale  
 I Coltellino con lama trapezoidale  
 E Cutter con filo trapezoidal  
 CN 实用刀



**x3** **SK5**

TRY ME  
DOUBLE  
BLISTER



**SK2** **x5** **LOCK** **ZINC ALLOY TPR**

SLIDING  
CARD



<b>YATO</b>	(mm)	
YT-7520	61x33x0.5	6/48

<b>YATO</b>	(mm)	
YT-7523	61x33x0.5	6/48

- GB Cutter knife  
 D Universalmesser  
 PL Nożyk z ostrzem trapezowym  
 RUS Ножи универсальные  
 CZ Univerzální nůž  
 H Univerzáls k s
- RO Cuțit universal  
 F Couteau lames trapésoïdale  
 I Coltellino con lama trapezoidale  
 E Cutter con filo trapezoidal  
 CN 实用刀

**x5** **SK5**



DOUBLE  
BLISTER



DOUBLE  
BLISTER



<b>YATO</b>	(mm)	
YT-7532	61x33x0.5	12/72

<b>YATO</b>	(mm)	
YT-7534	61x33x0.5	12/72

- GB U ii knife  
 D Universalmesser  
 PL Nożyk z łamanym ostrzem  
 RUS Нож универсальный  
 CZ Nůž na tapety  
 H Ta ao ó
- RO Cuțitaș pt. tapet  
 F Cutter à lames sécables  
 I Taglierino  
 E Cuchillo para papel de empapelar  
 CN 美工刀

SLIDING  
CARD

**SK5**



**x4**

<b>YATO</b>	(mm)	
YT-7500	9x0.4	24/240



**x5** **LOCK**

<b>YATO</b>	(mm)	
YT-7501	18x0.4	12/120



**x3** **AI HANDLE**

<b>YATO</b>	(mm)	
YT-7571	9x0.4	20/80
YT-7581	18x0.4	20/80



**x3** **LOCK**

<b>YATO</b>	(mm)	
YT-7510	25x0.7	6/48

- GB U ii knife  
D Universalmesser  
PL Nożyk z łamanym ostrzem  
RUS Нож универсальный  
CZ Nůž na tapety  
H Ta ao ó
- RO Cuțitaș pt. tapet  
F Cutter à lames sécables  
I Taglierino  
E Cuchillo para papel de empapelar  
CN 美工刀

SLIDING  
CARD



SK2



ABS

YATO	/// (mm)	
YT-7511	9x0.4	24/288
YT-7512	18x0.5	12/96

YATO	/// (mm)	
YT-7504	9x0.4	24/240
YT-7505	18x0.5	24/240



LOCK ABS  
TPR

x3 LOCK ABS  
TPR

YATO	/// (mm)	
YT-7506	9x0.4	24/240
YT-7507	18x0.5	12/144

YATO	/// (mm)	
YT-7503	18x0.5	12/144

- GB Spare blades  
D Abbrechklungen  
PL Ostrza za asowe  
RUS Лезвия для универсальных  
ножей  
CZ Lomené ostří náhradní  
H Törhető tartalékpenge
- RO Lame de rezervă rupte  
F Lame sécables pour le cutter  
I Lame di ricambio  
E Filo partido de recambio  
CN 美工刀刀片
- PLASTIC BOX & SLIDING CARD
- 10 PCS  
SK5

- GB Spare blades  
D Abbrechklungen  
PL Ostrza za asowe  
RUS Лезвия для универсальных  
ножей  
CZ Lomené ostří náhradní  
H Törhető tartalékpenge
- RO Lame de rezervă rupte  
F Lame sécables pour le cutter  
I Lame di ricambio  
E Filo partido de recambio  
CN 美工刀刀片
- PLASTIC BOX & SLIDING CARD
- 10 PCS  
SK2

10



YATO	/// (mm)	
YT-7530	25x0.7	6/48



YATO	/// (mm)	
YT-7531	61x33x0.5	24/144



YATO	/// (mm)	
YT-7528	9x0.4	24/144
YT-7529	18x0.5	24/144



YATO	/// (mm)	
YT-7524	9x0.4	24/240
YT-7525	18x0.5	24/144



YATO	/// (mm)	
YT-7527	61x33x0.5	24/144

- GB Electric scissors  
D Elektrische Schere  
PL Nożyczki dla elektryków  
RUS Ножницы универсальные  
CZ Elektrické nůžky  
H Univerzális óó
- RO Foarfecel electrice  
F Ciseaux pour electriciens  
I Forbici elettricisti  
E Tijeras eléctricas  
CN 电工剪
- 140 mm  
STAINLESS STEEL  
NERZEWNA  
HRC 5-5

- GB Scissors  
D Haushaltsschere  
PL Nożyczki  
RUS Ножницы  
CZ Nůžky  
H Óó
- RO Foarfecel  
F Ciseaux  
I Forbici  
E Tijeras  
CN 剪刀
- STAINLESS STEEL BLADE  
OSTRZE ZE STALI  
NERZEWNA



SLIDING  
CARD

YATO	L (mm)	
YT-1974	140	12/120



SLIDING  
CARD

YATO	L (mm)	
YT-19763	170	12/120
YT-19764	190	12/120
YT-19765	215	12/120
YT-19766	245	12/120
YT-19767	300	12/120

- |                          |                                      |                      |
|--------------------------|--------------------------------------|----------------------|
| GB Glass oil cutter      | H Olajkés üveghez                    | E Cuchillo de aceite |
| D Glasschneider          | RO Diamant pt. taiat stricla cu ulei | ara cris a ina ion   |
| PL Nóż olejowy do szkła  | F Couteau à l'huile pour verre       | CN 玻璃割刀              |
| RUS Стеклопerez масляный | I Taglia vetro con serbatoio olio    |                      |
| CZ Rezák na sklo         |                                      |                      |

SLIDING CARD



**YD05**  
TUNGSTEN CARBIDE TIP  
OSTRZE Z WĘGLIKA  
WOLFRAMU  
**HRA**  
92,5-93



<b>YATO</b>	L (mm)	
YT-7560	177	6/120

<b>YATO</b>	L (mm)	
YT-7561	178	6/120

- |  |   |   |
|--|---|---|
| GB Scriber for glass, ceramics and metal   | CZ Rýsovací jehla na sklo, keramiku a kov     | I Penna di vetro ceramica metallo         |
| D Reißnadel für Glas, Keramik und Metall   | H Karctű üveghez, kerámiához és fémhez        | E Trazador para vidrio, cerámica y metall |
| PL Rysik do szkła, ceramiki i metalu       | RO Ac de trasat pt. sticlă, ceramică și metal | CN 划线器                                    |
| RUS Штихель для стекла, керамика и металла | F Stylet verre, céramique et métal            |   |

SLIDING CARD



**140 mm**  
**YG6X**  
TUNGSTEN CARBIDE TIP  
OSTRZE Z WĘGLIKA  
WOLFRAMU



<b>YATO</b>	L (mm)	
YT-3740	140	6/240

- |   |   |  |
|---|---|--|
| GB Double edge trimmer                    | RO Rindea pt. finisaje                                |  |
| D Kantentrimmer                           | F Couteau reversible pour bois de placage             |  |
| PL Dwustronny nóż do odcinania ok ein     | I Do ioco e o   |  |
| RUS Двусторонний нож для мебельной пленки | E Cuchillo de doble filo para cortar chapas de madera |  |
| CZ Orezávací nuž na hrany lamina          | CN 双边刨子   |  |
| H Kétélű vágó                             |   |  |

**13-25 mm**

ONE SIDE CUTTING  
BOTH SIDE CUTTING

**SK5**



SLIDING CARD



<b>YATO</b>	
YT-5710	6/48

- |                    |                      |                                 |                         |
|--------------------|----------------------|---------------------------------|-------------------------|
| GB Profile gauge   | RUS Шаблон профилей  | RO Șablon profile               | I Profilato             |
| D Profilmuster     | CZ Profilová šablona | F Jauges d'épaisseurs métriques | E Plantilla de perfiles |
| PL Wzornik profili | H Profilsablon       |                                 | CN 轮廓仪                  |

SLIDING CARD



**44 mm**

**1.5 mm**



<b>YATO</b>	L (mm)	
YT-3735	125	24/72

<b>YATO</b>	L (mm)	
YT-3736	260	10/40

- |                                |  |
|--------------------------------|--|
| GB Punch set                   |  |
| D eder ochserse                |  |
| PL Przebiaki do skór           |  |
| RUS Набор пробойников для кожи |  |
| CZ Sada průbojníků na kůži     |  |
| H Bőryukasztó készlet          |  |
| RO Set producele               |  |
| F Kit de perçoirs à cuir       |  |
| I Set di punzoni               |  |
| E Juego de perforar en piel    |  |
| CN 冲孔器组套                       |  |



POUCH & COLOR BOX



**9**  
PCS

**15**  
PCS

<b>YATO</b>	size / rozmiar	
YT-3590	2.5; 3.0; 4.0; 5.0; 6.0; 7.0; 8.0; 9.0; 10.0	50

<b>YATO</b>	size / rozmiar	
YT-3591	2.0; 2.5; 3.2; 4.0; 4.8; 5.5; 6.4; 8.0; 9.5; 11.1; 12.7; 14.0; 15.8; 19.0; 22.0	10



- GB PVC pipe cutter  
D P C Rohrabsschneider  
PL Obcinak do rur PCV  
RUS Труборез для ПВХ труб  
CZ Řezač PVC trubek  
H Csővágó olló PVC csövekhez  
RO Clește pt. tăiat țevi din PVC  
F Coupeur aux tubes  
I Taglia tubi PVC  
E Cortatubos PVC  
CN PVC 管子割刀



max (mm) **35**  
PVC PP PU PE  
8Cr13 STAINLESS STEEL STAL NIERDZEWNA  
HRC **54**

SLIDING CARD

<b>YATO</b>	max. Ø (mm)	
YT-2230	35	6/48

- GB PVC pipe cutter  
D P C Rohrabsschneider  
PL Obcinak do rur PCV  
RUS Труборез для ПВХ труб  
CZ Řezač PVC trubek  
H Csővágó olló PVC csövekhez  
RO Clește pt. tăiat țevi din PVC  
F Coupeur aux tubes  
I Taglia tubi PVC  
E Cortatubos PVC  
CN PVC 管子割刀



max (mm) **42**  
PVC PP PU PE  
8Cr13 STAINLESS STEEL STAL NIERDZEWNA  
HRC **54**  
RATCHET SYSTEM ZAPADKOWY  
QUICK RELEASE SZYBKIE ZWALNIANIE

SLIDING CARD

<b>YATO</b>	max. Ø (mm)	
YT-2231	42	6/48

- GB PVC pipe cutter  
D P C Rohrabsschneider  
PL Obcinak do rur PCV  
RUS Труборез для ПВХ труб  
CZ Řezač PVC trubek  
H Csővágó olló PVC csövekhez  
RO Clește pt. tăiat țevi din PVC  
F Coupeur aux tubes  
I Taglia tubi PVC  
E Cortatubos PVC  
CN PVC 管子割刀



max (mm) **63**  
PVC PP PU PE  
8Cr13 STAINLESS STEEL STAL NIERDZEWNA  
HRC **56-58**  
RATCHET SYSTEM ZAPADKOWY  
QUICK RELEASE SZYBKIE ZWALNIANIE

SLIDING CARD

<b>YATO</b>	max. Ø (mm)	
YT-22312	63	6/24

- GB PVC pipe cutter  
D P C Rohrabsschneider  
PL Obcinak do rur PCV  
RUS Труборез для ПВХ труб  
CZ Řezač PVC trubek  
H Csővágó olló PVC csövekhez  
RO Clește pt. tăiat țevi din PVC  
F Coupeur aux tubes  
I Taglia tubi PVC  
E Cortatubos PVC  
CN PVC 管子割刀



SLIDING CARD



PVC PP PU PE  
8Cr13 STAINLESS STEEL STAL NIERDZEWNA  
HRC **54**  
AI  
RATCHET SYSTEM ZAPADKOWY  
QUICK RELEASE SZYBKIE ZWALNIANIE

max (mm) **51**

<b>YATO</b>	max. Ø (mm)	
YT-2228	51	6/24



max (mm) **64**

<b>YATO</b>	max. Ø (mm)	
YT-2229	64	6/24

- GB Pipe cutter  
D Rohrabsschneider  
PL Obcinak do rur  
RUS Труборез для труб  
CZ Řezač trubek  
H Csővágó olló csövekhez  
RO Clește pt. tăiat țevi  
F Coupeurs aux tubes  
I Rullo di taglio per tubi  
E Cortatubos  
CN 管子割刀

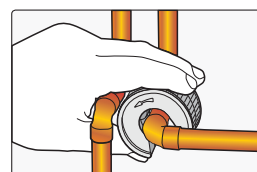

PLASTIC Al, Cu  
BEARING STEEL STAL ŁOŻYSKOWA

SLIDING CARD

<b>YATO</b>	Ø	external diameter / średnica zewnętrzna (mm)	
YT-22353	19/32" (15 mm)	48	10/100
YT-22354	23/32" (18 mm)	59	10/50
YT-22355	7/8" (22 mm)	56	10/50

GB Pipe cutter      CZ Řezač trubek      F Coupeur aux tubes  
 D Rohrabsschneider      H Csővágó olló      I Taglia tubi PVC  
 PL Obcinak do rur      csővekhez      E Cortatubos  
 RUS Труборіз для труб      RO Clește pt. țăiat țevi      CN 管子割刀

COLOR BOX



Ø 1/10"-7/8"  
 Ø 3-22 mm



<b>YATO</b>	Ø	
YT-22318	1/10"-7/8" (3-22 mm)	100



Ø 1/10"-5/4"  
 Ø 3-32 mm

QUICK-ADJUSTMENT  
 SZYBKONASTAWNY

WITH DEBURRER  
 Z GRATOWNIKIEM



<b>YATO</b>	Ø	
YT-22338	1/10"-5/4" (3-32 mm)	50



Ø 3/8"-1-5/8"  
 Ø 10-40 mm



<b>YATO</b>	Ø	
YT-2232	3/8"-1-5/8" (10-40 mm)	20



Ø 1/4"-7/4"  
 Ø 6-45 mm

WITH DEBURRER  
 Z GRATOWNIKIEM



<b>YATO</b>	Ø	
YT-2233	1/4"-7/4" (6-45 mm)	25



Ø 1/2"-5/2"  
 Ø 14-63 mm

QUICK-ADJUSTMENT  
 SZYBKONASTAWNY



<b>YATO</b>	Ø	
YT-2234	1/2"-5/2" (14-63 mm)	25



Ø 2"-5"  
 Ø 50-127 mm

QUICK-ADJUSTMENT  
 SZYBKONASTAWNY



<b>YATO</b>	Ø	
YT-2235	2"-5" (50-127 mm)	10

GB Replacement cutting wheel for pipe cutters  
 D rsa zschneider für Rohrabsschneider  
 PL Zapasowe kółko tnące do obcinaka do rur  
 RUS Запасной режущий диск для труборезов  
 CZ Náhradní řezné kolečko na trubky frézy

H Tartalék vágókerék cső vágó  
 RO Roata de schimb pt. taiere țevi  
 F Molette pour coupe  
 I Taglio ruote tubo taglierina  
 E Rueda de corte de repuesto para cortatubos  
 CN 管子割刀刀片



DOUBLE BLISTER

YATO	a (mm)	b (mm)	c (mm)	for/dla:	
YT-22313	18	6	4.8	YT-2233	50/300
YT-22314	26	14	7.5	YT-2232	6/108
YT-22315	18	6	4.8	YT-22338	50/300
YT-22316	27	6.3	5	YT-2234	24/288

GB Replacement cutting wheel for pipe cutters  
 D rsa zschneider für Rohrabsschneider  
 PL Zapasowe kółko tnące do obcinaka do rur  
 RUS Запасной режущий диск для труборезов  
 CZ Náhradní řezné kolečko na trubky frézy

H Tartalék vágókerék cső vágó  
 RO Roata de schimb pt. taiere țevi  
 F Molette pour coupe  
 I Taglio ruote tubo taglierina  
 E Rueda de corte de repuesto para cortatubos  
 CN 管子割刀刀片

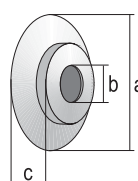

DOUBLE BLISTER

YATO	a (mm)	b (mm)	c (mm)	for/dla:	
YT-22317	44	10.6	8	YT-2235	12/144

GB Window scraper  
D Fensterabscheiber  
PL Skrobak do szyb  
RUS Скребок для стекла

CZ Škrabák na skla  
H Kaparó üveghez  
RO Răzuitor pt. geamuri  
F Gratte-givre

I Coeino con lama trapezoidale  
E Rascador de cristales  
CN 玻璃刮刀

HALF  
DOUBLE  
BLISTER



18x100  
mm

SK5

ALUMINIUM

ABS



YATO	L (mm)	
YT-7550	300	10/60



TELESCOPE  
HANDLE  
390-600  
mm

YATO	L (mm)	
YT-7551	390-600	10/60

GB Scraper  
D Ziehklinge  
PL Cklna  
RUS Цикля  
CZ Škrabka na arce  
H Simítógyalu

RO Honuitor  
F Racléuse métal  
I Raschio  
E Rasador  
CN 刮刀

HALF  
DOUBLE  
BLISTER



TUNGSTEN  
CARBIDE  
WEGLIK  
WOLFRAM



BLADE  
22mm

YATO	L (mm)	
YT-5702	240	6/48



BLADE  
50mm

YATO	L (mm)	
YT-5703	250	6/48



BLADE  
65mm

YATO	L (mm)	
YT-5704	290	6/48

GB Steel file  
 D erks a -Feie  
 PL Piłnik do metalu  
 RUS Напильник слесарный  
 CZ Zámeňický piľník  
 H Lakatos reszelő

RO Pila de lăcătușerie  
 F Lime à métal  
 I Lime per metallo  
 E Lima para metal  
 CN 锉

PLASTIC HANGER



#1	#2	#3	T12 STEEL
150 mm	200 mm	250 mm	300 mm



YATO		L (mm)		
	YT-6223	1	250	20/80
	YT-6180	2	150	20/80
	YT-6185	2	200	20/80
	YT-6228	2	250	20/80
	YT-6190	2	300	10/40
	YT-6233	3	250	20/80

YATO		L (mm)		
	YT-6224	1	250	20/80
	YT-6181	2	150	20/80
	YT-6186	2	200	20/80
	YT-6229	2	250	20/80
	YT-6191	2	300	10/40



YATO		L (mm)		
	YT-6225	1	250	20/80
	YT-6182	2	150	20/80
	YT-6187	2	200	20/80
	YT-6230	2	250	20/80
	YT-6192	2	300	10/40
	YT-6234	3	250	20/80

YATO		L (mm)		
	YT-6226	1	250	20/80
	YT-6183	2	150	20/80
	YT-6188	2	200	20/80
	YT-6231	2	250	20/80
	YT-6193	2	300	10/40
	YT-6235	3	250	20/80



YATO		L (mm)		
	YT-6227	1	250	20/80
	YT-6184	2	150	20/80
	YT-6189	2	200	20/80
	YT-6232	2	250	20/80
	YT-6194	2	300	10/40
	YT-6236	3	250	20/80

GB Steel file set  
 D erks a -Feien  
 PL Piłniki do metalu  
 RUS Набор напильников слесарных  
 CZ Zámeňické piľníky  
 H Lakatos reszelő

RO Pile de lăcătușerie  
 F Set de limes à métal  
 I Lime per metallo  
 E Juego de limas para metal  
 CN 钢锉组套

SLIDING CARD



#1	#2	#3
250 mm		T12 STEEL



3 PCS
#2
#2
#2



5 PCS
#1 #2
#1
#1
#1
#1



5 PCS
#3
#3
#3
#3
#3

YATO		
YT-6237	10/20	

YATO		
YT-6238	5/10	

YATO		
YT-6239	5/10	

GB Needle file set  
D Nadel-feilensatz  
PL Zestaw pilników iglaków  
RUS Набор напильников надфили  
CZ Sada jehlových pilníků  
H Tűreszelő készlet

RO Set de limes  
F Set de limes  
I Set di lime e lime ad ago  
E Juego de limas de aguja  
CN 什锦锉组套

POUCH

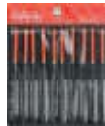

GCR15  
BEARING  
STEEL



6  
PCS

10  
PCS

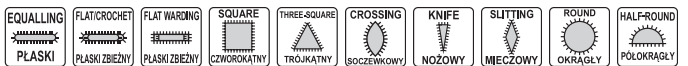

YATO	working length / długość robocza (mm)	mm	
YT-6160	65	3 140	50/200
YT-6161	75	4 160	25/100
YT-6162	85	5 180	25/100

YATO	working length / długość robocza (mm)	mm	
YT-6163	65	3 140	25/100
YT-6164	75	4 160	25/100
YT-6165	85	5 180	25/50

GB Diamond needle file  
D Diamant-Nadelfeile  
PL Pilnik iglak diamentowy  
RUS Надфиль алмазный

CZ Diamantový jehlový pilník  
H Gyémánt tűreszelő  
RO Pila diamentată  
F Lime diamant

I Lime ad ago diamentate  
E Lima de aguja adiamantada  
CN 金刚石平头扁锉

SLIDING  
CARD



GRIT  
ZIARNISTOŚĆ  
150



YATO	grit / ziarnistość	coating length / długość nasypu (mm)	mm	
YT-6140	150	50	3 140	120/1200
YT-6147	150	50	4 160	80/800
YT-6152	150	70	5 180	45/450

YATO	grit / ziarnistość	coating length / długość nasypu (mm)	mm	
YT-6141	150	50	3 140	120/1200
YT-6148	150	50	4 160	80/800
YT-6153	150	70	5 180	45/450

YATO	grit / ziarnistość	coating length / długość nasypu (mm)	mm	
YT-6142	150	50	3 140	120/1200
YT-6149	150	50	4 160	80/800
YT-6154	150	70	5 180	45/450

GB Diamond needle file set  
D Diamant-Nadelfeilensatz  
PL Zestaw pilników diamentowych iglaków  
RUS Набор надфилей алмазных  
CZ Sada diamentových jehlových pilníků  
H Gyémánt tűreszelő készlet

RO Set pile diamentate  
F Set de limes diamant  
I Set lime ad ago diamentate  
E Juego de limas de aguja adiamantadas  
CN 金刚石整形锉组套

POUCH



GRIT  
ZIARNISTOŚĆ  
150



3  
PCS

5  
PCS



YATO	grit / ziarnistość	coating length / długość nasypu (mm)	mm	
YT-6143	150	50	3 140	40/400
YT-6150	150	50	4 160	30/300
YT-6155	150	70	5 180	15/150

YATO	grit / ziarnistość	coating length / długość nasypu (mm)	mm	
YT-6156	150	70	5 180	10/100

- GB Diamond needle file set
- D Diamant-Nadelfeilsatz
- PL Zestaw pilników diamentowych iglaków
- RUS Набор надфилей алмазных
- CZ Sada diamentových jehlových pilníků
- H Gyémánt tűszelő készlet
- RO Set pile diamantate
- F Set de limes diamant
- I Set lime ad ago diamantate
- E Juego de limas de aguja adiamantadas
- CN 金刚石整形锉组套

POUCH



10  
PCS

GRIT  
ZIARNISTOŚĆ  
150



YATO	grit / ziarnistość	coating length / długość nasypu (mm)	mm	
YT-6144	150	50	3 140	12/120

YATO	grit / ziarnistość	coating length / długość nasypu (mm)	mm	
YT-6145	150	25	3 140	12/120



YATO	grit / ziarnistość	coating length / długość nasypu (mm)	mm	
YT-6146	150	30	3 140	12/120

YATO	grit / ziarnistość	coating length / długość nasypu (mm)	mm	
YT-6151	150	50	4 160	9/90

GB ood ras  
D Ho zras e  
PL Tarnik do drewna  
RUS Рашпиля для дерева  
CZ Rašple do dřeva  
H Fareszelő

RO Ras e  
F Lime à bois  
I Lime per legno  
E Escarpelo para madera  
CN 木工鏈



PLASTIC  
HANGER



250  
mm





# 45

<b>YATO</b> 	
YT-6219	45 12/72





# 45

<b>YATO</b> 	
YT-6220	45 12/72



# 45

<b>YATO</b> 	
YT-6221	45 12/72

GB ood ras se  
D Ho zras e sa z  
PL Tarniki do drewna  
RUS Рашпили для дерева  
CZ Sada rašplí do dřeva  
H Fareszelő

RO Se ras e  
F Set de limes à bois  
I Lime per legno  
E Juego de escarpelos para madera  
CN 木工鏈組套

SLIDING  
CARD





3  
PCS # 45

250  
mm # 45

# 45



<b>YATO</b> 	
YT-6222	45 5/20

GB Sandpaper PL Papier ścierny CZ Smirkový papír RO Hârtie abrazivă I Caraveira CN 砂纸  
 D Scheifpapier RUS Наждачная бумага H Csiszópapír F Pâier abrazif E Paedeira

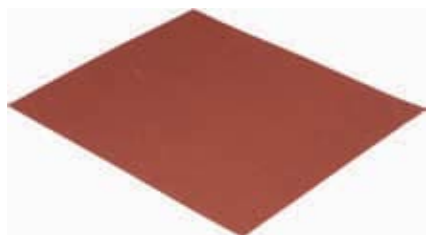

POLYBAG



- application: paint, lacquer, filler, wood
- abrasive: aluminium oxide
- bond: synthetic resin
- backing: C
- coating: semi open
- zastosowanie: farby, lakiery, szpachle, drewno
- ścierniwo: tlenek glinu
- spoiwo: żywica syntetyczna
- podkład: C
- nasyp półotwarty



- application: paint, lacquer, filler, wood
- abrasive: aluminium oxide
- bond: synthetic resin
- backing: D
- coating: semi open
- zastosowanie: farby, lakiery, szpachle, drewno
- ścierniwo: tlenek glinu
- spoiwo: żywica syntetyczna
- podkład: D
- nasyp półotwarty

YATO	grit / ziarnistość	size / rozmiar (mm)	PCS packing	
YT-8350	40	230 280	50	500
YT-8351	60	230 280	50	500
YT-8352	80	230 280	50	500
YT-8353	100	230 280	50	500
YT-8354	120	230 280	50	500
YT-8355	150	230 280	50	500
YT-8356	180	230 280	50	500
YT-8357	220	230 280	50	500
YT-8358	240	230 280	50	500

YATO	grit / ziarnistość	size / rozmiar	
YT-8449	40	93 mm x 5 m	12/48
YT-8450	60	93 mm x 5 m	12/48
YT-8451	80	93 mm x 5 m	12/48
YT-8452	100	93 mm x 5 m	12/48
YT-8453	120	93 mm x 5 m	12/48
YT-8454	150	93 mm x 5 m	12/48
YT-8455	180	93 mm x 5 m	12/48
YT-8456	240	93 mm x 5 m	12/48
YT-8457	320	93 mm x 5 m	12/48



POLYBAG WITH HEADER



- application: paint, lacquer, filler, wood
- abrasive: aluminium oxide
- bond: synthetic resin
- backing: D
- coating: semi open
- zastosowanie: farby, lakiery, szpachle, drewno
- ścierniwo: tlenek glinu
- spoiwo: żywica syntetyczna
- podkład: D
- nasyp półotwarty



- application: paint, lacquer, filler, wood
- abrasive: aluminium oxide
- bond: synthetic resin
- backing: D
- coating: semi open
- zastosowanie: farby, lakiery, szpachle, drewno
- ścierniwo: tlenek glinu
- spoiwo: żywica syntetyczna
- podkład: D
- nasyp półotwarty

YATO	grit / ziarnistość	size / rozmiar (mm)	PCS packing	
YT-8370	40	115 280	5	24/240
YT-8371	60	115 280	5	24/240
YT-8372	80	115 280	5	24/240
YT-8373	100	115 280	5	24/240
YT-8374	120	115 280	5	24/240
YT-8375	150	115 280	5	24/240
YT-8376	180	115 280	5	24/240
YT-8377	240	115 280	5	24/240
YT-8378	320	115 280	5	24/240

YATO	grit / ziarnistość	size / rozmiar	
YT-8440	40	115 mm x 5 m	12/48
YT-8441	60	115 mm x 5 m	12/48
YT-8442	80	115 mm x 5 m	12/48
YT-8443	100	115 mm x 5 m	12/48
YT-8444	120	115 mm x 5 m	12/48
YT-8445	150	115 mm x 5 m	12/48
YT-8446	180	115 mm x 5 m	12/48
YT-8447	240	115 mm x 5 m	12/48
YT-8448	320	115 mm x 5 m	12/48



POLYBAG



- application: paint, lacquer, filler, wood
- abrasive: aluminium oxide
- bond: synthetic resin
- backing: D
- coating: semi open
- zastosowanie: farby, lakiery, szpachle, drewno
- ścierniwo: tlenek glinu
- spoiwo: żywica syntetyczna
- podkład: D
- nasyp półotwarty



- application: paint, lacquer, filler, wood
- abrasive: aluminium oxide
- bond: synthetic resin
- backing: D
- coating: semi open
- zastosowanie: farby, lakiery, szpachle, drewno
- ścierniwo: tlenek glinu
- spoiwo: żywica syntetyczna
- podkład: D
- nasyp półotwarty

YATO	grit / ziarnistość	size / rozmiar (mm)	PCS packing	
YT-8360	40	230 280	50	500
YT-8361	60	230 280	50	500
YT-8362	80	230 280	50	500
YT-8363	100	230 280	50	500
YT-8364	120	230 280	50	500
YT-8365	150	230 280	50	500
YT-8366	180	230 280	50	500
YT-8367	240	230 280	50	500
YT-8368	320	230 280	50	500

YATO	grit / ziarnistość	size / rozmiar	
YT-8458	40	115 mm x 50 m	2
YT-8459	60	115 mm x 50 m	2
YT-8460	80	115 mm x 50 m	2
YT-8461	100	115 mm x 50 m	2
YT-8462	120	115 mm x 50 m	2
YT-8463	150	115 mm x 50 m	2
YT-8464	180	115 mm x 50 m	2
YT-8465	240	115 mm x 50 m	2
YT-8466	320	115 mm x 50 m	2



GB Sandpaper PL Papier ścierny CZ Smrkový papír RO Hârtie abrazivă I Carabera E Carabera CN 砂纸  
D Schleifpapier RUS Наждачная бумага H Csiszó a r F Papier abrasif E Paedea



- application: paint, lacquer, filler, wood
- abrasive: aluminium oxide
- bond: synthetic resin
- backing: F
- coating: closed

- zastosowanie: farby, lakiery, szpachle, drewno
- ścierniwo: tlenek glinu
- spoiwo: żywica syntetyczna
- podkład: F
- nasyp pełny

- application: paint, lacquer, filler, wood
- abrasive: aluminium oxide
- bond: synthetic resin
- backing: F
- coating: closed

- zastosowanie: farby, lakiery, szpachle, drewno
- ścierniwo: tlenek glinu
- spoiwo: żywica syntetyczna
- podkład: F
- nasyp pełny

YATO	grit / ziarnistość	size / rozmiar	PCS
YT-8480	80	150 mm x 50 m	2
YT-8481	100	150 mm x 50 m	2
YT-8482	120	150 mm x 50 m	2

YATO	grit / ziarnistość	size / rozmiar	PCS
YT-8483	40	200 mm x 50 m	2
YT-8484	60	200 mm x 50 m	2
YT-8485	80	200 mm x 50 m	2
YT-8486	120	200 mm x 50 m	2

GB abrasive cloth RUS Шлифовальное полотно RO Coianza abraziva E Hoasdeno abrasivo CN 砂布  
D Schleifgewebeblatt CZ Brusné plátno F Tissu abrasif E Hoasdeno abrasivo CN 砂布  
PL Plótno ściernie arkusz H Csiszó óvászon a I Carabera



WATERPROOF  
WODOODPORNY

POLYBAG

WATERPROOF  
WODOODPORNY

POLYBAG

- application: paint, lacquer, filler
- abrasive: silicon carbide
- bond: synthetic resin
- backing: C
- coating: closed

- zastosowanie: farby, lakiery, szpachle
- ścierniwo: węgiel krzemu
- spoiwo: żywica syntetyczna
- podkład: C
- nasyp pełny

- application: paint, lacquer, filler
- abrasive: silicon carbide
- bond: synthetic resin
- backing: A
- coating: closed

- zastosowanie: farby, lakiery, szpachle
- ścierniwo: węgiel krzemu
- spoiwo: żywica syntetyczna
- podkład: A
- nasyp pełny

YATO	grit / ziarnistość	size / rozmiar (mm)	PCS
YT-8400	60	230 280	50 500
YT-8401	80	230 280	50 500
YT-8402	100	230 280	50 500
YT-8403	120	230 280	50 500
YT-8404	150	230 280	50 500

YATO	grit / ziarnistość	size / rozmiar (mm)	PCS
YT-8405	180	230 280	50 500
YT-8406	220	230 280	50 500
YT-8407	240	230 280	50 500
YT-8408	280	230 280	50 500
YT-8409	320	230 280	50 500
YT-8410	360	230 280	50 500
YT-8411	400	230 280	50 500
YT-8412	500	230 280	50 500
YT-8413	600	230 280	50 500
YT-8414	800	230 280	50 500
YT-8415	1000	230 280	50 500
YT-8416	1200	230 280	50 500
YT-8417	1500	230 280	50 500
YT-8418	2000	230 280	50 500



- application: metal, wood
- abrasive: aluminium oxide
- bond: semi-resin
- backing: J
- coating: close

- zastosowanie: metal, drewno
- ścierniwo: tlenek glinu
- spoiwo: żywica
- podkład: J
- nasyp pełny

POLYBAG

YATO	grit / ziarnistość	size / rozmiar (mm)	PCS
YT-83160	36	230 280	50 250
YT-83161	40	230 280	50 250
YT-83162	60	230 280	50 250
YT-83163	80	230 280	50 250
YT-83164	100	230 280	50 250
YT-83165	120	230 280	50 500
YT-83166	150	230 280	50 500
YT-83167	180	230 280	50 500
YT-83168	220	230 280	50 500
YT-83169	240	230 280	50 500

GB abrasive cloth  
 D Schleifgewebe rolle  
 PL Płótno ściernie rolka

RUS Рулон-шлифовальное полотно  
 CZ Brusné plátno role  
 H Csiszó óvászon ekercs

RO Roala nza abraziva  
 F Tissu abrasif rouleau  
 I Carave r a r o o

E Roode ano abrasivo  
 CN 砂布



- application: metal, wood
- abrasive: aluminium oxide
- bond: semi-resin
- backing: J
- coating: close
- zastosowanie: metal, drewno
- ścierniwo: tlenek glinu
- spoiwo: żywica
- podkład: J
- nasyp pełny
- application: metal, wood
- abrasive: aluminium oxide
- bond: semi-resin
- backing: J
- coating: close
- zastosowanie: metal, drewno
- ścierniwo: tlenek glinu
- spoiwo: żywica
- podkład: J
- nasyp pełny
- application: metal, wood
- abrasive: aluminium oxide
- bond: semi-resin
- backing: J
- coating: close
- zastosowanie: metal, drewno
- ścierniwo: tlenek glinu
- spoiwo: żywica
- podkład: J
- nasyp pełny

YATO	grit / ziarnistość	size / rozmiar	PCS
YT-83180	36	150 mm x 30 m	2
YT-83181	40	150 mm x 30 m	2

YATO	grit / ziarnistość	size / rozmiar	PCS
YT-83182	50	150 mm x 50 m	2
YT-83183	60	150 mm x 50 m	2
YT-83184	80	150 mm x 50 m	2
YT-83185	100	150 mm x 50 m	2
YT-83186	120	150 mm x 50 m	2
YT-83187	150	150 mm x 50 m	2
YT-83188	180	150 mm x 50 m	2
YT-83189	220	150 mm x 50 m	2
YT-83190	240	150 mm x 50 m	2

YATO	grit / ziarnistość	size / rozmiar	PCS
YT-83200	24	200mm x 30 m	2
YT-83201	36	200mm x 30 m	2
YT-83202	40	200mm x 30 m	2
YT-83203	50	200mm x 30 m	2
YT-83204	60	200mm x 30 m	2
YT-83205	80	200mm x 30 m	2
YT-83206	100	200mm x 30 m	2
YT-83207	120	200mm x 30 m	2
YT-83208	150	200mm x 30 m	2
YT-83209	180	200mm x 30 m	2
YT-83210	220	200mm x 30 m	2
YT-83211	240	200mm x 30 m	2

10

GB Endless sanding belt  
 D Sch eifband  
 PL Taśma ścierna bezkońcowa

RUS Шлифовальные ленты  
 CZ Brusný pás  
 H Csiszoló szalag

RO Bandă de pânză  
 F Bande abrasive sans fin  
 I Nastro abrasivo senza fine

E Pano abrasivo cinturón  
 CN 砂帶

TIED ON CARD



- application: metal, wood
- abrasive: aluminium oxide
- bond: synthetic resin
- coating: close
- zastosowanie: metal, drewno
- ścierniwo: tlenek glinu
- spoiwo: żywica syntetyczna
- nasyp pełny
- application: metal, wood
- abrasive: aluminium oxide
- bond: synthetic resin
- coating: close
- zastosowanie: metal, drewno
- ścierniwo: tlenek glinu
- spoiwo: żywica syntetyczna
- nasyp pełny

YATO	grit / ziarnistość	size / rozmiar (mm)	PCS packing
YT-09743	60	10 330	10 100
YT-09744	80	10 330	10 100
YT-09745	100	10 330	10 100
YT-09746	120	10 330	10 100

YATO	grit / ziarnistość	size / rozmiar (mm)	PCS packing
YT-09747	60	20 520	10 50
YT-09748	80	20 520	10 50
YT-09749	100	20 520	10 50
YT-09750	120	20 520	10 50

GB No end abrasive band  
 D Sch eifband  
 PL Pas ścierny bezkońcowa

RUS Шлифлента бесконечная  
 CZ Brusný pás  
 H Csiszoló szalag

RO Curea abraziva  
 F Bande abrasive sans fin  
 I Nastro abrasivo senza fine

E Banda abrasiva sin fin  
 CN 砂帶



- application: metal, wood
- abrasive: aluminium oxide
- bond: synthetic resin
- coating: close
- zastosowanie: metal, drewno
- ścierniwo: tlenek glinu
- spoiwo: żywica syntetyczna
- nasyp pełny
- application: metal, wood
- abrasive: aluminium oxide
- bond: synthetic resin
- coating: close
- zastosowanie: metal, drewno
- ścierniwo: tlenek glinu
- spoiwo: żywica syntetyczna
- nasyp pełny
- application: metal, wood
- abrasive: aluminium oxide
- bond: synthetic resin
- coating: close
- zastosowanie: metal, drewno
- ścierniwo: tlenek glinu
- spoiwo: żywica syntetyczna
- nasyp pełny

YATO	grit / ziarnistość	size / rozmiar (mm)	PCS packing
YT-83220	36	75 457	5 20/60
YT-83221	40	75 457	5 20/60
YT-83222	60	75 457	5 20/60
YT-83223	80	75 457	5 20/60
YT-83224	100	75 457	5 20/60
YT-83225	120	75 457	5 20/60
YT-83226	150	75 457	5 20/60

YATO	grit / ziarnistość	size / rozmiar (mm)	PCS packing
YT-83227	36	75 533	5 20/60
YT-83228	40	75 533	5 20/60
YT-83229	60	75 533	5 20/60
YT-83230	80	75 533	5 20/60
YT-83231	100	75 533	5 20/60
YT-83232	120	75 533	5 20/60
YT-83233	150	75 533	5 20/60

YATO	grit / ziarnistość	size / rozmiar (mm)	PCS packing
YT-83234	36	100 610	5 10/30
YT-83235	40	100 610	5 10/30
YT-83236	60	100 610	5 10/30
YT-83237	80	100 610	5 20/60
YT-83238	100	100 610	5 20/60
YT-83239	120	100 610	5 20/60
YT-83240	150	100 610	5 20/60

GB Flap disc – regular shape  
D Fächerschleifscheibe - Gerade  
PL Ściernica listkowa talerzowa płaska  
RUS Круг лепестковый тарельчатый  
CZ Lamelový brusný kotouč  
H Lamellás csiszoló normál

RO Disc lamelar frontal  
F Disque à lamelles abrasives plat  
I Disco abrasivo per metallo  
E Discos de a o abrasivo  
CN 百叶轮

- application: metal
- abrasive: aluminium oxide
- bond: synthetic resin
- backing: fibreglass
- zastosowanie: metal
- ścierniwo: tlenek glinu
- spoiwo: żywica syntentyczna
- podkład: włókno szklane



YATO	grit / ziarnistość	size / rozmiar (mm)	
YT-83251	36	115x22.4	50/200
YT-83252	40	115x22.4	50/200
YT-83253	60	115x22.4	50/200
YT-83254	80	115x22.4	50/200
YT-83255	100	115x22.4	50/200
YT-83256	120	115x22.4	50/200

GB Flap disc – regular shape  
D Fächerschleifscheibe - Gerade  
PL Ściernica listkowa talerzowa płaska  
RUS Круг лепестковый тарельчатый  
CZ Lamelový brusný kotouč  
H Lamellás csiszoló normál

RO Disc lamelar frontal  
F Disque à lamelles abrasives plat  
I Disco abrasivo per metallo  
E Discos de a o abrasivo  
CN 百叶轮

- application: metal
- abrasive: aluminium oxide
- bond: synthetic resin
- backing: fibreglass
- zastosowanie: metal
- ścierniwo: tlenek glinu
- spoiwo: żywica syntentyczna
- podkład: włókno szklane



YATO	grit / ziarnistość	size / rozmiar (mm)	
YT-83271	36	125x22.4	25/100
YT-83272	40	125x22.4	25/100
YT-83273	60	125x22.4	50/200
YT-83274	80	125x22.4	50/200
YT-83275	100	125x22.4	50/200
YT-83276	120	125x22.4	50/200

GB Fa disc de ressed sha e  
D Fächerschleifscheibe - Gewölbt  
PL Ściernica listkowa talerzowa wypukła  
RUS Круг лепестковый тарельчатый  
CZ Lamelový brusný kotouč - vypouklý  
H Lamellás csiszoló dőntött  
RO Disc lamelar frontal depresat

F Disque à lamelles abrasives bombé  
I Disco abrasivo a cen ro de resso  
E Discos de paño abrasivo centro embutido  
CN 百叶轮

- application: metal
- abrasive: aluminium oxide
- bond: synthetic resin
- backing: fibreglass
- zastosowanie: metal
- ścierniwo: tlenek glinu
- spoiwo: żywica syntentyczna
- podkład: włókno szklane



YATO	grit / ziarnistość	size / rozmiar (mm)	
YT-83281	36	115x22.4	50/200
YT-83282	40	115x22.4	50/200
YT-83283	60	115x22.4	50/200
YT-83284	80	115x22.4	50/200
YT-83285	100	115x22.4	50/200
YT-83286	120	115x22.4	50/200

GB Fa disc de ressed sha e  
D Fächerschleifscheibe - Gewölbt  
PL Ściernica listkowa talerzowa wypukła  
RUS Круг лепестковый тарельчатый  
CZ Lamelový brusný kotouč - vypouklý  
H Lamellás csiszoló dőntött  
RO Disc lamelar frontal depresat

F Disque à lamelles abrasives bombé  
I Disco abrasivo a cen ro de resso  
E Discos de paño abrasivo centro embutido  
CN 百叶轮

- application: metal
- abrasive: aluminium oxide
- bond: synthetic resin
- backing: fibreglass
- zastosowanie: metal
- ścierniwo: tlenek glinu
- spoiwo: żywica syntentyczna
- podkład: włókno szklane



YATO	grit / ziarnistość	size / rozmiar (mm)	
YT-83291	36	125x22.4	25/100
YT-83292	40	125x22.4	25/100
YT-83293	60	125x22.4	50/200
YT-83294	80	125x22.4	50/200
YT-83295	100	125x22.4	50/200
YT-83296	120	125x22.4	50/200

GB Flap disc – regular shape  
D Fächerschleifscheibe - Gerade  
PL Ściernica listkowa talerzowa płaska  
RUS Круг лепестковый тарельчатый  
CZ Lamelový brusný kotouč  
H Lamellás csiszoló normál

RO Disc lamelar frontal  
F Disque à lamelles abrasives plat  
I Disco abrasivo per metallo  
E Discos de a o abrasivo  
CN 百叶轮

- application: metal, inox
- abrasive: zirconia aluminium oxide
- bond: synthetic resin
- backing: fibreglass
- zastosowanie: metal, stal nierdzewna
- ścierniwo: tlenek glinu / dwutlenek c rkonu
- spoiwo: żywica syntentyczna
- podkład: włókno szklane



YATO	grit / ziarnistość	size / rozmiar (mm)	
YT-83301	36	115x22.4	50/200
YT-83302	40	115x22.4	50/200
YT-83303	60	115x22.4	50/200
YT-83304	80	115x22.4	50/200
YT-83305	100	115x22.4	50/200
YT-83306	120	115x22.4	50/200

GB Flap disc – regular shape  
D Fächerschleifscheibe - Gerade  
PL Ściernica listkowa talerzowa płaska  
RUS Круг лепестковый тарельчатый  
CZ Lamelový brusný kotouč  
H Lamellás csiszoló normál

RO Disc lamelar frontal  
F Disque à lamelles abrasives plat  
I Disco abrasivo per metallo  
E Discos de a o abrasivo  
CN 百叶轮

- application: metal, inox
- abrasive: zirconia aluminium oxide
- bond: synthetic resin
- backing: fibreglass
- zastosowanie: metal, stal nierdzewna
- ścierniwo: tlenek glinu / dwutlenek c rkonu
- spoiwo: żywica syntentyczna
- podkład: włókno szklane



YATO	grit / ziarnistość	size / rozmiar (mm)	
YT-83311	36	125x22.4	25/100
YT-83312	40	125x22.4	25/100
YT-83313	60	125x22.4	25/100
YT-83314	80	125x22.4	50/200
YT-83315	100	125x22.4	50/200
YT-83316	120	125x22.4	50/200

GB Fa disc de ressed sha e  
D Fächerschleifscheibe - Gewölbt  
PL Ściernica listkowa talerzowa wypukła  
RUS Круг лепестковый тарельчатый  
CZ Lamelový brusný kotouč - vypouklý  
H Lamellás csiszoló dőntött  
RO Disc lamelar frontal depresat

F Disque à lamelles abrasives bombé  
I Disco abrasivo a cen ro de resso  
E Discos de paño abrasivo centro embutido  
CN 百叶轮

- application: metal, inox
- abrasive: zirconia aluminium oxide
- bond: synthetic resin
- backing: fibreglass
- zastosowanie: metal, stal nierdzewna
- ścierniwo: tlenek glinu / dwutlenek c rkonu
- spoiwo: żywica syntentyczna
- podkład: włókno szklane



YATO	grit / ziarnistość	size / rozmiar (mm)	
YT-83321	36	115x22.4	50/200
YT-83322	40	115x22.4	50/200
YT-83323	60	115x22.4	50/200
YT-83324	80	115x22.4	50/200
YT-83325	100	115x22.4	50/200
YT-83326	120	115x22.4	50/200

GB Fa disc de ressed sha e  
D Fächerschleifscheibe - Gewölbt  
PL Ściernica listkowa talerzowa wypukła  
RUS Круг лепестковый тарельчатый  
CZ Lamelový brusný kotouč - vypouklý  
H Lamellás csiszoló dőntött  
RO Disc lamelar frontal depresat

F Disque à lamelles abrasives bombé  
I Disco abrasivo a cen ro de resso  
E Discos de paño abrasivo centro embutido  
CN 百叶轮

- application: metal, inox
- abrasive: zirconia aluminium oxide
- bond: synthetic resin
- backing: fibreglass
- zastosowanie: metal, stal nierdzewna
- ścierniwo: tlenek glinu / dwutlenek c rkonu
- spoiwo: żywica syntentyczna
- podkład: włókno szklane



YATO	grit / ziarnistość	size / rozmiar (mm)	
YT-83331	36	125x22.4	25/100
YT-83332	40	125x22.4	25/100
YT-83333	60	125x22.4	25/100
YT-83334	80	125x22.4	50/200
YT-83335	100	125x22.4	50/200
YT-83336	120	125x22.4	50/200

GB Fa wheel with shaft  
D Fächerschleifmop mit Schaft  
PL Ściernica listkowa trzpieniowa  
RUS Круг лепестковый со шпинделем

CZ Lamelový kotouč s hřídelí  
H Legyző csiszoló csapos  
RO Perie abraziva circulara cu tija  
F Disque à lamelles abrasives pivot

I Ruote lamellari  
E Rueda laminar en tela abrasiva  
CN 百叶轮



- application: metal
- abrasive: aluminium oxide
- bond: synthetic resin
- zastosowanie: metal
- ścierniwo: tlenek glinu
- spoiwo: żywica syntetyczna

- application: metal
- abrasive: aluminium oxide
- bond: synthetic resin
- zastosowanie: metal
- ścierniwo: tlenek glinu
- spoiwo: żywica syntetyczna

YATO	grit / ziarnistość	size / rozmiar (mm)	
YT-83351	40	40 20 6	10/60
YT-83352	60	40 20 6	10/60
YT-83353	80	40 20 6	10/60
YT-83354	100	40 20 6	10/60
YT-83355	120	40 20 6	10/60
YT-83356	150	40 20 6	10/60

YATO	grit / ziarnistość	size / rozmiar (mm)	
YT-83361	40	60 30 6	10/60
YT-83362	60	60 30 6	10/60
YT-83363	80	60 30 6	10/60
YT-83364	100	60 30 6	10/60
YT-83365	120	60 30 6	10/60
YT-83366	150	60 30 6	10/60



- application: metal
- abrasive: aluminium oxide
- bond: synthetic resin
- zastosowanie: metal
- ścierniwo: tlenek glinu
- spoiwo: żywica syntetyczna

- application: metal
- abrasive: aluminium oxide
- bond: synthetic resin
- zastosowanie: metal
- ścierniwo: tlenek glinu
- spoiwo: żywica syntetyczna

YATO	grit / ziarnistość	size / rozmiar (mm)	
YT-83371	40	80 30 6	10/60
YT-83372	60	80 30 6	10/60
YT-83373	80	80 30 6	10/60
YT-83374	100	80 30 6	10/60
YT-83375	120	80 30 6	10/60
YT-83376	150	80 30 6	10/60

YATO	grit / ziarnistość	size / rozmiar (mm)	
YT-83381	40	80 40 6	10/60
YT-83382	60	80 40 6	10/60
YT-83383	80	80 40 6	10/60
YT-83384	100	80 40 6	10/60
YT-83385	120	80 40 6	10/60
YT-83386	150	80 40 6	10/60

GB Fa wheel with shaft  
D Fächerschleifmop mit Schaft  
PL Ściernica listkowa trzpieniowa  
RUS Круг лепестковый со шпинделем  
CZ Lamelový kotouč s hřídelí  
H Legyző csiszoló csapos

RO Perie abraziva circulara cu tija  
F Disque à lamelles abrasives pivot  
I Ruote lamellari  
E Rueda laminar en tela abrasiva  
CN 百叶轮



- application: metal
- abrasive: aluminium oxide
- bond: synthetic resin
- zastosowanie: metal
- ścierniwo: tlenek glinu
- spoiwo: żywica syntetyczna

- application: metal
- abrasive: aluminium oxide
- bond: synthetic resin
- zastosowanie: metal
- ścierniwo: tlenek glinu
- spoiwo: żywica syntetyczna

- application: metal
- abrasive: aluminium oxide
- bond: synthetic resin
- zastosowanie: metal
- ścierniwo: tlenek glinu
- spoiwo: żywica syntetyczna

YATO	grit / ziarnistość	size / rozmiar (mm)	
YT-83390	60	50 30 6	10/60
YT-83391	100	50 30 6	10/60
YT-83392	150	50 30 6	10/60
YT-83393	200	50 30 6	10/60

YATO	grit / ziarnistość	size / rozmiar (mm)	
YT-83394	60	60 50 6	10/60
YT-83395	100	60 50 6	10/60
YT-83396	150	60 50 6	10/60
YT-83397	200	60 50 6	10/60

YATO	grit / ziarnistość	size / rozmiar (mm)	
YT-83398	60	80 50 6	10/60
YT-83399	100	80 50 6	10/60
YT-83400	150	80 50 6	10/60
YT-83401	200	80 50 6	10/60

GB abrasive disc  
D Scheif a ier  
zum Gummiteller  
PL Krażek ścierny  
RUS Круг шлифовальный  
CZ Brusný kotouč  
H Csiszó ó árcsa  
RO Disc abraziv  
F Disques abrasifs avec velcro  
I Disco abrasivo  
E Juego de discos  
abrasivos  
CN 圆形砂纸



TIED ON CARD  
5 PCS  
HOOK FASTENER  
RZEP

- application: metal, wood
- abrasive: aluminium oxide
- bond: synthetic resin
- backing: C
- coating: semi open
- zastosowanie: metal, drewno
- ścierniwo: tlenek glinu
- spoiwo: żywica syntetyczna
- podkład: C
- nasyp półotwarty

YATO	grit / ziarnistość	Ø (mm)	
YT-83420	36	115	50/200
YT-83421	40	115	50/200
YT-83422	60	115	50/200
YT-83423	80	115	50/200
YT-83424	100	115	50/200
YT-83425	120	115	50/200
YT-83426	150	115	50/200
YT-83427	180	115	50/200
YT-83428	220	115	50/200



GB abrasive disc  
D Scheif a ier  
zum Gummiteller  
PL Krażek ścierny  
RUS Круг шлифовальный  
CZ Brusný kotouč  
H Csiszó ó árcsa  
RO Disc abraziv  
F Disques abrasifs avec velcro  
I Disco abrasivo  
E Juego de discos  
abrasivos  
CN 圆形砂纸



TIED ON CARD  
5 PCS  
HOOK FASTENER  
RZEP

- application: metal, wood
- abrasive: aluminium oxide
- bond: synthetic resin
- backing: C
- coating: semi open
- zastosowanie: metal, drewno
- ścierniwo: tlenek glinu
- spoiwo: żywica syntetyczna
- podkład: C
- nasyp półotwarty

YATO	grit / ziarnistość	Ø (mm)	
YT-83430	36	125	50/200
YT-83431	40	125	50/200
YT-83432	60	125	50/200
YT-83433	80	125	50/200
YT-83434	100	125	50/200
YT-83435	120	125	50/200
YT-83436	150	125	50/200
YT-83437	180	125	50/200
YT-83438	220	125	50/200



GB abrasive disc with holes  
D Scheif a ier  
zum Gummiteller mit lochen  
PL Krażek ścierny z otworami  
RUS Круг шлифовальный  
перфорированный с липучкой  
CZ Brusný kotouč z otvorama  
H Fibertárcsa lyukakkal tépózárs  
RO Disc abraziv cu orificii  
F Disques abrasifs trous avec velcro  
I Disco abrasivo con fori  
E Juego de discos abrasivos con agujeros  
CN 圆形带孔砂纸



TIED ON CARD  
5 PCS  
HOOK FASTENER  
RZEP

- application: metal, wood
- abrasive: aluminium oxide
- bond: synthetic resin
- backing: C
- coating: semi open
- zastosowanie: metal, drewno
- ścierniwo: tlenek glinu
- spoiwo: żywica syntetyczna
- podkład: C
- nasyp półotwarty

YATO	grit / ziarnistość	Ø (mm)	
YT-83440	36	115	50/200
YT-83441	40	115	50/200
YT-83442	60	115	50/200
YT-83443	80	115	50/200
YT-83444	100	115	50/200
YT-83445	120	115	50/200
YT-83446	150	115	50/200
YT-83447	180	115	50/200
YT-83448	220	115	50/200



GB abrasive disc with holes  
D Scheif a ier  
zum Gummiteller mit lochen  
PL Krażek ścierny z otworami  
RUS Круг шлифовальный  
перфорированный с липучкой  
CZ Brusný kotouč z otvorama  
H Fibertárcsa lyukakkal tépózárs  
RO Disc abraziv cu orificii  
F Disques abrasifs trous avec velcro  
I Disco abrasivo con fori  
E Juego de discos abrasivos con agujeros  
CN 圆形带孔砂纸



TIED ON CARD  
5 PCS  
HOOK FASTENER  
RZEP

- application: metal, wood
- abrasive: aluminium oxide
- bond: synthetic resin
- backing: C
- coating: semi open
- zastosowanie: metal, drewno
- ścierniwo: tlenek glinu
- spoiwo: żywica syntetyczna
- podkład: C
- nasyp półotwarty

YATO	grit / ziarnistość	Ø (mm)	
YT-83450	36	125	50/200
YT-83451	40	125	50/200
YT-83452	60	125	50/200
YT-83453	80	125	50/200
YT-83454	100	125	50/200
YT-83455	120	125	50/200
YT-83456	150	125	50/200
YT-83457	180	125	50/200
YT-83458	220	125	50/200

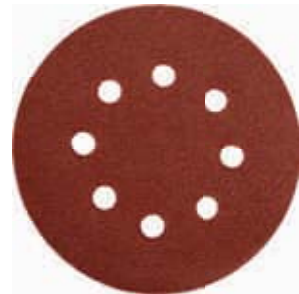

GB abrasive sheet with holes  
D Schleifgewebe-scheiben mit lochen  
PL Arkusz ścierny z otworami  
RUS Шлифовальная перфорированная  
бумага для виброшлифмашины  
CZ Brusné archy z otvorama  
H Csiszoló lap lyukakkal  
RO Coale (foi) abrazive cu orificii  
F Disques abrasifs trous avec velcro  
I Disco abrasivo con fori  
E Ojas abrasivas con agujeros  
CN 方形带孔砂纸



TIED ON CARD  
5 PCS  
HOOK FASTENER  
RZEP

- application: paint, lacquer, filler
- abrasive: aluminium oxide
- bond: synthetic resin
- backing: C
- coating: semi open
- zastosowanie: farby, lakiery, szpachle
- ścierniwo: tlenek glinu
- spoiwo: żywica syntetyczna
- podkład: C
- nasyp półotwarty

YATO	grit / ziarnistość	size / rozmiar (mm)	
YT-83480	40	93 180	25/100
YT-83481	60	93 180	25/100
YT-83482	80	93 180	25/100
YT-83483	100	93 180	25/100
YT-83484	120	93 180	25/100
YT-83485	150	93 180	50/200
YT-83486	180	93 180	50/200
YT-83487	220	93 180	50/200
YT-83488	240	93 180	50/200



GB abrasive sheet with holes  
D Schleifgewebe-scheiben mit lochen  
PL Arkusz ścierny z otworami  
RUS Шлифовальная перфорированная  
бумага для виброшлифмашины  
CZ Brusné archy z otvorama  
H Csiszoló lap lyukakkal  
RO Coale (foi) abrazive cu orificii  
F Disques abrasifs trous avec velcro  
I Disco abrasivo con fori  
E Ojas abrasivas con agujeros  
CN 方形带孔砂纸



TIED ON CARD  
5 PCS  
HOOK FASTENER  
RZEP

- application: metal, wood
- abrasive: aluminium oxide
- bond: synthetic resin
- backing: C
- coating: semi open
- zastosowanie: metal, drewno
- ścierniwo: tlenek glinu
- spoiwo: żywica syntetyczna
- podkład: C
- nasyp półotwarty

YATO	grit / ziarnistość	size / rozmiar (mm)	
YT-83490	40	93 230	25/100
YT-83491	60	93 230	25/100
YT-83492	80	93 230	25/100
YT-83493	100	93 230	25/100
YT-83494	120	93 230	25/100
YT-83495	150	93 230	25/100
YT-83496	180	93 230	25/100
YT-83497	220	93 230	25/100
YT-83498	240	93 230	25/100



# 11

## Hydraulic tools Narzędzia hydrauliczne



Ratchet die stock sets  
Komplety gwintownic ręcznych

224



Hand flaring tools sets  
Praski do rozszerzania rur

229



Accessories for ratchet die stock  
Akcesoria do gwintownic ręcznych

224



Burners & soldering tools  
Palniki i lutownice

230-231



Pipe wrenches  
Klucze do rur

225-226



Pipe welders  
Zgrzewarki do rur

231



Chain pipe wrenches  
Klucze do rur łańcuchowe

226



Hinged pipe vices  
Imadła zaciskowe do rur

232



Water pump pliers  
Szczypce nastawne

226



Deburrers & accessories  
Gratowniki i akcesoria

232



Pipe cutters  
Obcinaki do rur

227-228



Pipe brushes  
Szczotki do rur

232



Pipe benders  
Giętarki do rur

229



GB Ra che die s ocks  
 D Rohrgewinde-schneidsatz  
 PL Zestaw gwintownic  
 RUS Набор плашек  
 CZ Sada závitníků  
 H Mene fűró k sze  
 RO Trusa filiere  
 F Taraud manuel  
 I Filiera per tubi a mano  
 E Juego de roscar  
 CN 管子铰板组套



9Cr2

BMC & COLOR SLEEVE



5 PCS	3/8"	1/2"	3/4"	1"
	10mm	12.5mm	19mm	25mm

YATO	size / rozmiar	
YT-29001	3/8" (10.0 mm); 1/2" (12.5 mm); 3/4" (19.0 mm); 1" (25.0 mm)	4

11



7 PCS	1/4"	3/8"	1/2"	3/4"	1"	5/4"
	6.3mm	10mm	12.5mm	19mm	25mm	32mm

YATO	size / rozmiar	
YT-2900	1/4" (6.3 mm); 3/8" (10.0 mm); 1/2" (12.5 mm); 3/4" (19.0 mm); 1" (25.0 mm); 5/4" (32.0 mm)	4

GB Spare knives for ra che die s ock  
 D Rohrgewinde-Schneidbacken  
 PL Noże zapasowe do gwintownicy ręcznej  
 RUS Запасные ножи для оправки  
 CZ Náhradní nože do ruční závitofezy  
 H Tartalék kések, racsnis csőmenetvágóhoz

RO Cutit de rezerva pt. filiera  
 F Lame pour taraud à main  
 I Lame di ricambio per filettatrici manuale  
 E Filos de recambio para terraja de mano  
 CN 板牙

4  
PCS  
9Cr2



POLYBAG WITH HEADER



YATO	size / rozmiar	PCS packing:	
YT-2910	1/4" (6.3 mm)	4	50/200
YT-2911	3/8" (10.0 mm)	4	50/200
YT-2912	1/2" (12.5 mm)	4	50/200
YT-2913	3/4" (19.0 mm)	4	50/200
YT-2914	1" (25.0 mm)	4	50/200

GB Spare head for ra che die s ock  
 D Rohrgewinde-Schneidköpfe  
 PL Głowica zapasowa do gwintownicy ręcznej  
 RUS Запасная оправка для нарезания трубной резьбы  
 CZ Náhradní hlava pro ruční závitofez  
 H Tartalék fej, racsnis csőmenetvágóhoz  
 RO Ca de rezerva pt. placa filetat cu clichet  
 F Mandrin porte-taraud

I Testina ricambio per filettatrici manuale  
 E Cabeza de recambio para terraja de mano  
 CN 板牙头

9Cr2



COLOR BOX





YATO	size / rozmiar	
YT-2916	1/4" (6.3 mm)	10/40
YT-2917	3/8" (10.0 mm)	10/40
YT-2918	1/2" (12.5 mm)	10/40
YT-2919	3/4" (19.0 mm)	10/40
YT-2920	1" (25.0 mm)	10/40
YT-2921	5/4" (32.0 mm)	10/40



GB Pipe wrench  
D Rohrschlüssel  
PL Klucz do rur  
RUS Ключ трубный  
CZ Klíč součástí  
na trubky  
H Csőkulcs  
RO Cheie reglabila pt. tevi  
F Clé aux tubes  
I Chiave per tubi  
E Llave para tubos  
CN 铝合金管钳

CrMo HRC 55-60 Al HANDLE





YATO 	size / rozmiar	max. pipe diameter / max. średnica rury	
YT-2482	14" (350 mm)	2" (50 mm)	6/12
YT-2483	18" (450 mm)	2.5" (63 mm)	2/10
YT-2484	24" (600 mm)	3" (75 mm)	2/6
YT-2485	36" (900 mm)	5" (125 mm)	3

GB Pipe wrench  
D Rohrschlüssel  
PL Klucz do rur  
RUS Ключ трубный  
CZ Klíč součástí  
na trubky  
H Csőkulcs  
RO Cheie reglabila pt. tevi  
F Clé aux tubes  
I Chiave per tubi  
E Llave para tubos  
CN 铝合金管钳

CrMo HRC 55-60





YATO 	size / rozmiar	max. pipe diameter / max. średnica rury	
YT-2488	10" (250 mm)	1" (25 mm)	6/18
YT-2489	12" (300 mm)	1.5" (38 mm)	6/12
YT-2490	14" (350 mm)	2" (50 mm)	2/10
YT-2491	18" (450 mm)	2.5" (63 mm)	3/6
YT-2492	24" (600 mm)	3" (75 mm)	2/4
YT-2493	36" (900 mm)	5" (125 mm)	1
YT-2494	48" (1200 mm)	6" (150 mm)	1

GB Pipe wrench  
D Rohrschlüssel  
PL Klucz do rur  
RUS Ключ трубный  
CZ Klíč součástí  
na trubky  
H Csőkulcs  
RO Cheie reglabila pt. tevi  
F Clé serre-tube  
I Chiave per tubi  
E Llave para tubos  
CN 铝合金管钳

HRC 55-60 OFFSET TYPE





YATO 	size / rozmiar	max. pipe diameter / max. średnica rury	
YT-2201	10" (250 mm)	1" (25 mm)	6/36
YT-2203	14" (350 mm)	1.5" (38 mm)	4/16
YT-2204	18" (450 mm)	2" (50 mm)	3/12
YT-2205	24" (600 mm)	2.5" (63 mm)	3/6
YT-2206	36" (900 mm)	4" (100 mm)	2/4

GB Pipe wrench  
D Rohrschlüssel  
PL Klucz do rur  
RUS Ключ трубный  
CZ Klíč součástí  
na trubky  
H Csőkulcs  
RO Cheie reglabila pt. tevi  
F Clé aux tubes  
I Chiave per tubi  
E Llave para tubos  
CN 铝合金管钳

HRC 55-60 Al HANDLE



YATO 	size / rozmiar	max. pipe diameter / max. średnica rury	
YT-2222	12" (300 mm)	1" (25 mm)	6/24
YT-2223	14" (350 mm)	1.5" (38 mm)	4/16
YT-2224	18" (450 mm)	2" (50 mm)	3/12
YT-2225	24" (600 mm)	2.5" (63 mm)	3/6

- GB Adjustable pipe wrench  
D Rohrschlüssel  
PL Klucz nastawny do rur  
RUS Ключ трубный переставной
- CZ Nastavitelný klíč na trubky  
H Állítható csőkulcs  
RO Cheie reglabilă pt. țevi  
F Clé serre-tube „suédois”
- I Pinze regolabili per tubi  
E Llave para tubos tipo Inglesa  
CN 鷹嘴鉗

COLOR BOX



90°	1"	1.5"	2"
	25 mm	38 mm	50 mm
DIN 5234		CrV 6140	



YATO	max. pipe diameter / max. średnica rury	L (mm)	
YT-2210	1" (25 mm)	320	24
YT-2211	1.5" (38 mm)	420	18
YT-2212	2" (50 mm)	560	12

- GB Adjustable pipe wrench  
D Rohrschlüssel  
PL Klucz nastawny do rur  
RUS Ключ трубный переставной
- CZ Nastavitelný klíč na trubky  
H Állítható csőkulcs  
RO Cheie reglabilă pt. țevi  
F Clé serre-tube „suédois”
- I Pinze regolabili per tubi  
E Llave para tubos tipo Inglesa  
CN 鷹嘴鉗

COLOR BOX



45°	1"	1.5"	2"
	25 mm	38 mm	50 mm
DIN 5234		CrV 6140	



YATO	max. pipe diameter / max. średnica rury	L (mm)	
YT-2213	1" (25 mm)	330	24
YT-2214	1.5" (38 mm)	415	18
YT-2215	2" (50 mm)	530	12

- GB Adjustable pipe wrench  
D Rohrschlüssel  
PL Klucz nastawny do rur  
RUS Ключ трубный переставной
- CZ Nastavitelný klíč na trubky  
H Állítható csőkulcs  
RO Cheie reglabilă pt. țevi  
F Clé serre-tube „suédois”
- I Pinze regolabili per tubi  
E Llave para tubos tipo Inglesa  
CN 鷹嘴鉗

COLOR BOX



S	1"	1.5"	2"
	25 mm	38 mm	50 mm
DIN 5234		CrV 6140	



YATO	max. pipe diameter / max. średnica rury	L (mm)	
YT-2216	1" (25 mm)	330	24
YT-2217	1.5" (38 mm)	420	18
YT-2218	2" (50 mm)	535	12

- GB Chain i e wrench  
D Kettenrohrzange  
PL Klucz łańcuchowy do rur  
RUS Ключ цепной для труб  
CZ Klíč řetězový na trubky  
H Láncos csőfogó  
RO Cheie reglabila pt. tevi cu lant  
F C à chaîne  
I Chiave a catena per tubi  
E llave de cadena  
CN 链条管子钳



SLIDING CARD



4"	300 mm
Ø 100 mm	
INDUCTION HARDENED TEETH DEBY HARTOWANE ZĘBYSKI	ADJUSTABLE WORKING RANGE REGULOWANY ZAKRES PRACY

YATO	L (mm)	max. pipe diameter / max. średnica rury	
YT-22260	300	4" (100 mm)	6/24

- GB Water pump pliers  
D Wasserpumpenzange  
PL Szcz ęce nas awne  
RUS Клещи переставные  
CZ Kelešt ę siko  
H Vizpumpfagó
- RO Cleste papagal  
F Pince réglable  
I Pinze regolabili  
E ica es de fon anero ajustables  
CN 水泵鉗

250 mm	300 mm	CrV
--------	--------	-----



YATO	L (mm)	
YT-2090	250	6/36
YT-2091	300	6/36

- GB Water pump pliers  
D Wasserpumpenzange  
PL Szcz ęce nas awne  
RUS Клещи переставные  
CZ Kelešt ę siko  
H Vizpumpfagó
- RO Cleste papagal  
F Pince réglable  
I Pinze regolabili  
E ica es de fon anero ajustables  
CN 水泵鉗

250 mm	6 mm	CrV
--------	------	-----

JAW WIDTH SZEROKOSC SZCZEK 6 mm  
WORKING RANGE ADJUSTMENT REGULACJA ZAKRESU PRACY  
STRENGTHENED JAWS WZMOCNIONA KONSTRUKCJA



YATO	L (mm)	
YT-20911	250	10/50

- GB Water pump pliers  
D Wasserpumpenzange  
PL Szcz ęce nas awne  
RUS Клещи переставные  
CZ Kelešt ę siko  
H Vizpumpfagó
- RO Cleste papagal  
F Pince réglable  
I Pinze regolabili  
E ica es de fon anero ajustables  
CN 水泵鉗

HALF DOUBLE BLISTER



250 mm	NICKEL IRON FINISH
--------	--------------------



YATO	L (mm)	
YT-2069	250	6/36



YATO	L (mm)	
YT-2070	250	6/24

- GB PVC pipe cutter  
D P C Rohrabscneider  
PL Obcinak do rur PCV  
RUS Труборез для ПВХ труб  
CZ Řezač PVC trubek  
H Csővágó olló PVC csövekhez  
RO Clește pt. tăiat țevi din PVC  
F Coupeur aux tubes  
I Taglia tubi PVC  
E Cortatubos PVC  
CN PVC 管子割刀



max (mm) **35**  
PVC PP PU PE  
8Cr13 STAINLESS STEEL STAL NIERDZEWNA  
HRC **54**

SLIDING CARD



<b>YATO</b>	max. Ø (mm)	
YT-2230	35	6/48

- GB PVC pipe cutter  
D P C Rohrabscneider  
PL Obcinak do rur PCV  
RUS Труборез для ПВХ труб  
CZ Řezač PVC trubek  
H Csővágó olló PVC csövekhez  
RO Clește pt. tăiat țevi din PVC  
F Coupeur aux tubes  
I Taglia tubi PVC  
E Cortatubos PVC  
CN PVC 管子割刀



max (mm) **42**  
PVC PP PU PE  
8Cr13 STAINLESS STEEL STAL NIERDZEWNA  
HRC **54**  
RATCHET SYSTEM ZAPADKOWY  
QUICK RELEASE SZYBKIE ZWALNIANIE

SLIDING CARD



<b>YATO</b>	max. Ø (mm)	
YT-2231	42	6/48

- GB PVC pipe cutter  
D P C Rohrabscneider  
PL Obcinak do rur PCV  
RUS Труборез для ПВХ труб  
CZ Řezač PVC trubek  
H Csővágó olló PVC csövekhez  
RO Clește pt. tăiat țevi din PVC  
F Coupeur aux tubes  
I Taglia tubi PVC  
E Cortatubos PVC  
CN PVC 管子割刀



max (mm) **63**  
PVC PP PU PE  
8Cr13 STAINLESS STEEL STAL NIERDZEWNA

HRC **56-58**  
RATCHET SYSTEM ZAPADKOWY  
QUICK RELEASE SZYBKIE ZWALNIANIE

SLIDING CARD



<b>YATO</b>	max. Ø (mm)	
YT-22312	63	6/24

- GB PVC pipe cutter  
D P C Rohrabscneider  
PL Obcinak do rur PCV  
RUS Труборез для ПВХ труб  
CZ Řezač PVC trubek  
H Csővágó olló PVC csövekhez  
RO Clește pt. tăiat țevi din PVC  
F Coupeur aux tubes  
I Taglia tubi PVC  
E Cortatubos PVC  
CN PVC 管子割刀



SLIDING CARD



PVC PP PU PE  
8Cr13 STAINLESS STEEL STAL NIERDZEWNA  
HRC **54**

AI  
RATCHET SYSTEM ZAPADKOWY  
QUICK RELEASE SZYBKIE ZWALNIANIE

max (mm) **51**

<b>YATO</b>	max. Ø (mm)	
YT-2228	51	6/24



max (mm) **64**

<b>YATO</b>	max. Ø (mm)	
YT-2229	64	6/24

- GB Pipe cutter  
D Rohrabscneider  
PL Obcinak do rur  
RUS Труборез для труб  
CZ Řezač trubek  
H Csővágó olló csövekhez  
RO Clește pt. tăiat țevi  
F Coupeurs aux tubes  
I Rullo di taglio per tubi  
E Cortatubos  
CN 管子割刀

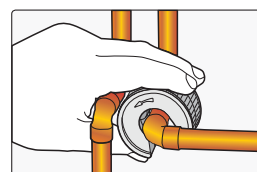

PLASTIC Al, Cu  
BEARING STEEL STAL ŁOŻYSKOWA

SLIDING CARD



<b>YATO</b>	Ø	external diameter / średnica zewnętrzna (mm)	
YT-22353	19/32" (15 mm)	48	10/100
YT-22354	23/32" (18 mm)	59	10/50
YT-22355	7/8" (22 mm)	56	10/50

GB Pipe cutter      CZ Řezač trubek      F Coupeur aux tubes  
 D Rohrschneider      H Csővágó olló      I Taglia tubi PVC  
 PL Obcinak do rur      csővekhez      E Cortatubos  
 RUS Труборіз для труб      RO Clește pt. țăiat țevi      CN 管子割刀

COLOR BOX



∅ 1/10"-7/8"  
 ∅ 3-22 mm



<b>YATO</b>	∅	
YT-22318	1/10"-7/8" (3-22 mm)	100



∅ 1/10"-5/4"  
 ∅ 3-32 mm

QUICK-ADJUSTMENT  
 SZYBKONASTAWNY

WITH DEBURRER  
 Z GRATOWNIKIEM



<b>YATO</b>	∅	
YT-22338	1/10"-5/4" (3-32 mm)	50



∅ 3/8"-1-5/8"  
 ∅ 10-40 mm



<b>YATO</b>	∅	
YT-2232	3/8"-1-5/8" (10-40 mm)	20



∅ 1/4"-7/4"  
 ∅ 6-45 mm

WITH DEBURRER  
 Z GRATOWNIKIEM

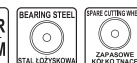

<b>YATO</b>	∅	
YT-2233	1/4"-7/4" (6-45 mm)	25



∅ 1/2"-5/2"  
 ∅ 14-63 mm

QUICK-ADJUSTMENT  
 SZYBKONASTAWNY

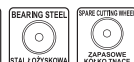

<b>YATO</b>	∅	
YT-2234	1/2"-5/2" (14-63 mm)	25



∅ 2"-5"  
 ∅ 50-127 mm

QUICK-ADJUSTMENT  
 SZYBKONASTAWNY



<b>YATO</b>	∅	
YT-2235	2"-5" (50-127 mm)	10

GB Replacement cutting wheel for pipe cutters  
 D rsa zschneider für Rohrschneider  
 PL Zapasowe kółko tnące do obcinaka do rur  
 RUS Запасной режущий диск для труборезов  
 CZ Náhradní řezné kolečko na trubky frézy

H Tartalék vágókerék cső vágó  
 RO Roata de schimb pt. taiere țevi  
 F Molette pour coupe  
 I Taglio ruote tubo taglierina  
 E Rueda de corte de repuesto para cortatubos  
 CN 管子割刀刀片

2 PCS

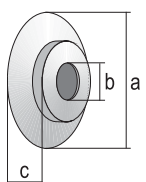

DOUBLE BLISTER

<b>YATO</b>	a (mm)	b (mm)	c (mm)	for/dla:	
YT-22313	18	6	4.8	YT-2233	50/300
YT-22314	26	14	7.5	YT-2232	6/108
YT-22315	18	6	4.8	YT-22338	50/300
YT-22316	27	6.3	5	YT-2234	24/288

GB Replacement cutting wheel for pipe cutters  
 D rsa zschneider für Rohrschneider  
 PL Zapasowe kółko tnące do obcinaka do rur  
 RUS Запасной режущий диск для труборезов  
 CZ Náhradní řezné kolečko na trubky frézy

H Tartalék vágókerék cső vágó  
 RO Roata de schimb pt. taiere țevi  
 F Molette pour coupe  
 I Taglio ruote tubo taglierina  
 E Rueda de corte de repuesto para cortatubos  
 CN 管子割刀刀片

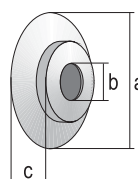

DOUBLE BLISTER

<b>YATO</b>	a (mm)	b (mm)	c (mm)	for/dla:	
YT-22317	44	10.6	8	YT-2235	12/144

- GB 3 in 1 mini bender  
D 3 in 1 Mini-Bieger  
PL Giętarka do rur  
RUS Мини-трубогиб 3 в 1  
CZ 3 in 1 mini ohýbačka  
H K kezes ha ó  
RO 3 in 1 mini dispozitiv de indoit teava

- F Cintreuse aux tubes  
I Tubo manuale bender  
E 3 in 1 mini curvadoras manuales de tubos  
CN 弯管器

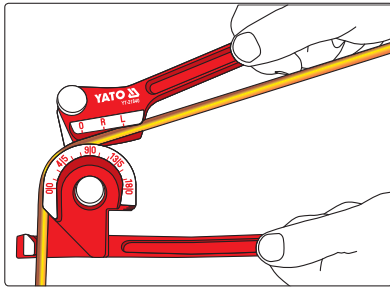

180°	1/4"	5/16"
	6.3mm	8mm
3/8"	SOFT STEEL MIĘKKA STAL	
	10mm	COPPER MOSIADZ
Al, Cu		

COLOR BOX



YATO	Ø	Box
YT-21840	1/4" (6.3 mm); 5/16" (8 mm); 3/8" (10 mm)	20

- GB Standard two handed bender  
D Standard-Zweihand-Bieger  
PL Giętarka do rur  
RUS Стандартный двуручный трубогиб  
CZ Standardní dvouruční ohýbačka  
H K kezes ha ó  
RO Dispozitiv de indoit teava

- F Cintreuse aux tubes  
I Tubo manuale bender  
E Curvadoras manuales de tubos  
CN 弯管器

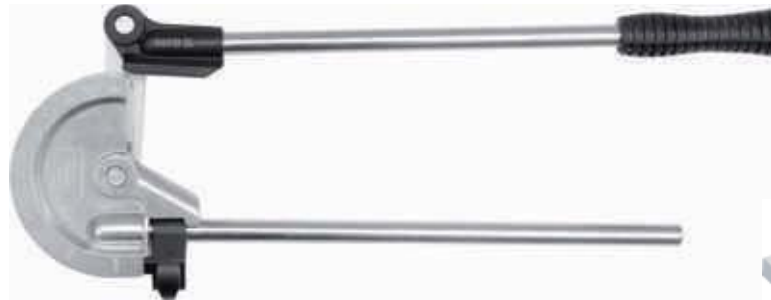
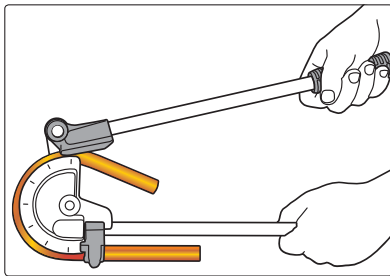

180°	Al, Cu	SOFT STEEL MIĘKKA STAL
	COPPER MOSIADZ	

WHITE CARTON BOX & COLOR LABEL



YATO	Ø	Box
YT-21842	15/32" (12 mm)	20
YT-21843	9/16" (14 mm)	10
YT-21844	9/32" (15 mm)	10
YT-21845	5/8" (16 mm)	10
YT-21846	23/32" (18 mm)	10

- GB Hand flaring tools set  
D Handpresse zum Aufweiten von Rohren  
PL Praska do ręcznego rozszerzania rur  
RUS Пресс для ручного расширения труб  
CZ Přípravek na ruční rozšířování konců trubek  
H Kézi csőtágító  
RO Presă manuală pt. lățirea țevilor  
F Set pour étendre les tubes  
I Presa per tubi  
E Prensa para la elongación manual de tubos  
CN 扩孔器组套

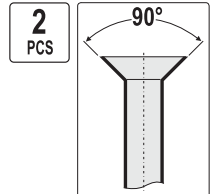

COLOR BOX



YATO	Ø (mm)	Box
YT-2182	22 25 28	20

- GB Hand flaring tools set  
D Handpresse zum Aufweiten von Rohren  
PL Praska do ręcznego rozszerzania rur  
RUS Пресс для ручного расширения труб  
CZ Přípravek na ruční rozšířování konců trubek  
H Kézi csőtágító  
RO Presă manuală pt. lățirea țevilor  
F Set pour étendre les tubes  
I Presa per tubi  
E Prensa para la elongación manual de tubos  
CN 扩孔器组套

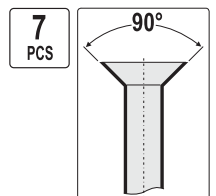

BMC & COLOR SLEEVE



YATO	Ø (mm)	Box
YT-2180	3 5 6 8 10 12 14 15 16 19	10

GB Gas torch  
D Gasbrenner  
PL Palnik gazowy  
RUS Газовая паяльная  
лампа  
CZ Plynový hořák  
H Gázégő

RO Arzător de gaz  
F Bruleur à gaz  
I Saldatore bruciatore  
a gas  
E Soplete de gas  
CN 火焰枪



**YATO**  
YT-6700 6/24

GB Gas torch  
D Gasbrenner  
PL Palnik gazowy  
RUS Газовая паяльная  
лампа  
CZ Plynový hořák  
H Gázégő

RO Arzător de gaz  
F Bruleur à gaz  
I Saldatore bruciatore  
a gas  
E Soplete de gas  
CN 火焰枪

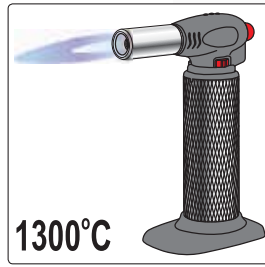

**YATO**  
YT-36700 10/20

GB Butane soldering tool  
D Gaslötkolben  
PL Lutownica gazowa  
RUS Паяльник газовый  
CZ P nová á ka  
H Forrasztópisztoly ceruza  
bután gáz üzemű  
RO Surubelnita sudura cu gaz  
F Fer à souder à gaz  
I Saldatore a gas  
E Microsoldador de butano portátil  
CN 瓦斯焊接工具



**YATO**  
YT-6705 25-80 12/72

GB Soldering tool set  
D Gaslötkolben satz  
PL Lutownica gazowa z akcesoriami  
RUS Газовый паяльный набор  
CZ Plynova pajka souprava  
H Gaz forrasztópáka készletek

RO Set ciocan de lipit cu gaz  
F Fer à souder à gaz  
I Saldatore a gas  
E Soldador a gas con accesorios  
CN 自动点火多功能瓦斯组套

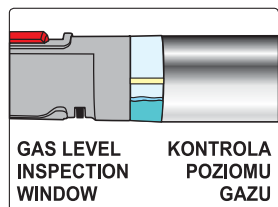
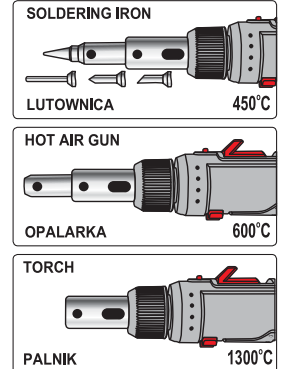
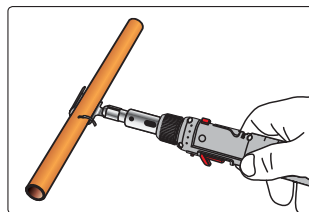

**YATO**  
YT-36706 30-125 6

- GB Butane soldering tool  
D Gaslötkolben  
PL Lutownica gazowa  
RUS Паяльник газовый  
CZ P nová á ka  
H Forrasztópisztoly ceruza  
bután gáz üzemű  
RO Surubelnita sudura cu gaz  
F Fer à souder à gaz  
I Saldatore a gas  
E Microsoldador de butano portátil  
CN 瓦斯焊接工具



SLIDING CARD

<b>YATO</b>		
YT-6706	30-125	12/48

- GB Soldering tool 3 in 1  
D Gaslötkolben 3 in 1  
PL Lutownica gazowa 3 w 1  
RUS Газовый паяльник 3-в-1  
CZ P nova á ka 3 in 1  
H Gaz-forrasztópaka 3 in 1  
RO Ciocan de lipit cu gaz 3 in 1  
F Fer à souder à gaz  
I Saldatore a gas  
E Soldador de gas 3 in 1  
CN 瓦斯焊接工具

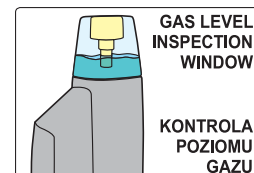

SLIDING CARD

<b>YATO</b>		
YT-36704	30-70	12/72

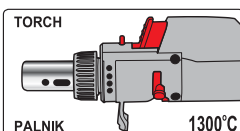
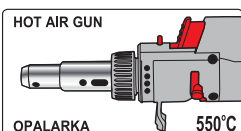
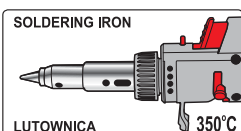

- GB Gas blow torch  
D ö brenner  
PL Palnik gazowy  
RUS Газовая горелка  
CZ Plynový hořák  
H Gázégő
- RO Arzător de gaz  
F Bruleur à gaz  
I Saldatore bruciatore a gas  
E Soplete de gas  
CN 火焰枪



SLIDING CARD

<b>YATO</b>		
YT-36709	1.28	6/12

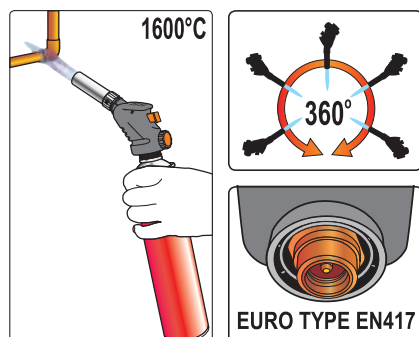

- GB P C asic i e w e r  
D Schweißgerät für thermoplastische Rohre  
PL Zgrzewarka do rur termoplastycznych  
RUS Сварочная машина для термопластиковых труба  
CZ Svářečka na termoplastické trubky  
H Hegesztő berendezés termoplasztikus csövekhez  
RO Masina de sudat levi termoplastice
- F Soudeur en tuyauterie en PVC  
I Polifusore saldatore per tubi  
E Maquina de soldar las tubos termoplasticos  
CN 热熔器

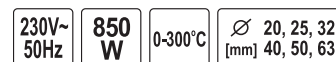

METAL CASE & COLOR BOX



<b>YATO</b>		
YT-82250	850	2

- GB Hinged pipe vice
- D Rohrschraubstock
- PL Imadło zaciskowe do rur
- RUS Тиски для труб
- CZ Upínací svěrák na trubky
- H Satu, csőszorító
- RO Menghină pt. tevi
- F Étau de serrage à tuyaux
- I Morsa stringi tubo
- E Tornillo de apriete para tubos
- CN 管子台虎钳



S55C



YATO	Ø (mm)	
YT-6510	60	4
YT-6511	76	2
YT-6512	90	2
YT-6513	110	1

- GB Universal quick deburrer
- RO Debavurator rapid universal
- D Universal-Schnell-Entgrater
- F Ébavureur
- PL Gratownik
- I Utensile di sbavatura
- RUS Универсальный быстро гратосниматель
- E Desbarbador rápida universal
- CZ Univerzální rychlo odhro ován
- CN 去毛刺修边器
- H Univerzális gyors sorjátlanító

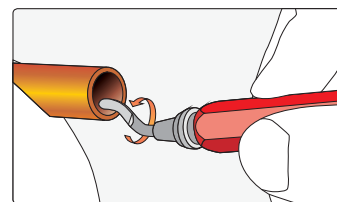

HSS M2

BODY KORPUS 12 mm

EXCHANGEABLE ROTATING BLADE  
WYMIENNE OBRACANE OSTRZE

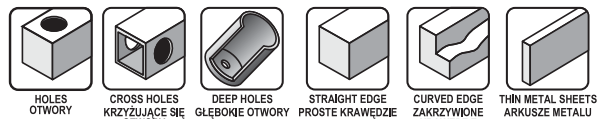

SLIDING CARD

YATO	
YT-22360	50/150

- GB Replacement blade for deburrer
- D Ersatzklinge für Entgrater
- PL Ostrza zapasowe do gratownika
- RUS Лезвие для снятия заусенцев
- CZ Náhradní čepel pro odjehlování
- H Tartalék penge sorjázásához
- RO Cuițit de schimb pt. debavurare
- F Set le lames pour ébavureur
- I Set di lame per sbavatura utensile
- E Cuchilla de repuesto para desbarbar
- CN 修边器刀片

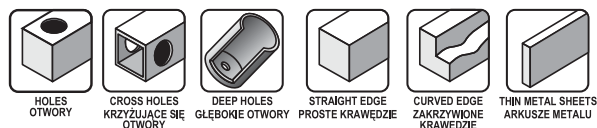

SLIDING CARD

for / dla: YT-22360

YATO	
YT-22361	12/144

- GB Copper pipe internal brush
- D Kupferrohr Innenbürste
- PL Szczotka wewnętrzna do rur miedzianych
- RUS Щетка для внутренней очистки труб
- CZ Kartač vnitřní na měděné trubky
- H Rézcső belső tisztító kefe
- RO Perii de interior pt. tevi de cupru
- F Brosse aux tubes en cuivre
- I Spazzola per il rame interno
- E Cepillo para limpieza de tubos de cobre
- CN 管子刷

STAINLESS STEEL WIRE  
DRUT ZE STALI  
NEROZŻEWNEJ

- GB Copper pipe brush 2 in 1
- D 2-in-1 Kupferrohrbürste für Innen- und Außenreinigung
- PL Szczotka do rur miedzianych 2 w 1
- RUS Щетка для внутренней и внешней зачистки медных труб
- CZ Kartač vnitřní a vnější na měděné trubky

- H Rézcső tisztító kefe 2 in 1
- RO Perii pt. tevi de cupru 2 in 1
- F Brosse aux tubes en cuivre
- I Spazzola per il tubi di rame 2 in 1
- E 2-en-1 cepillo para limpieza de tubos de cobre int. y ext
- CN 2合1管子刷

STAINLESS STEEL WIRE  
DRUT ZE STALI  
NEROZŻEWNEJ



YATO	Ø (mm)	
YT-63701	15	12/120
YT-63702	18	12/120
YT-63703	22	12/120
YT-63704	28	12/120



SLIDING CARD

YATO	Ø (mm)	
YT-63705	15 22	50/100



Memo

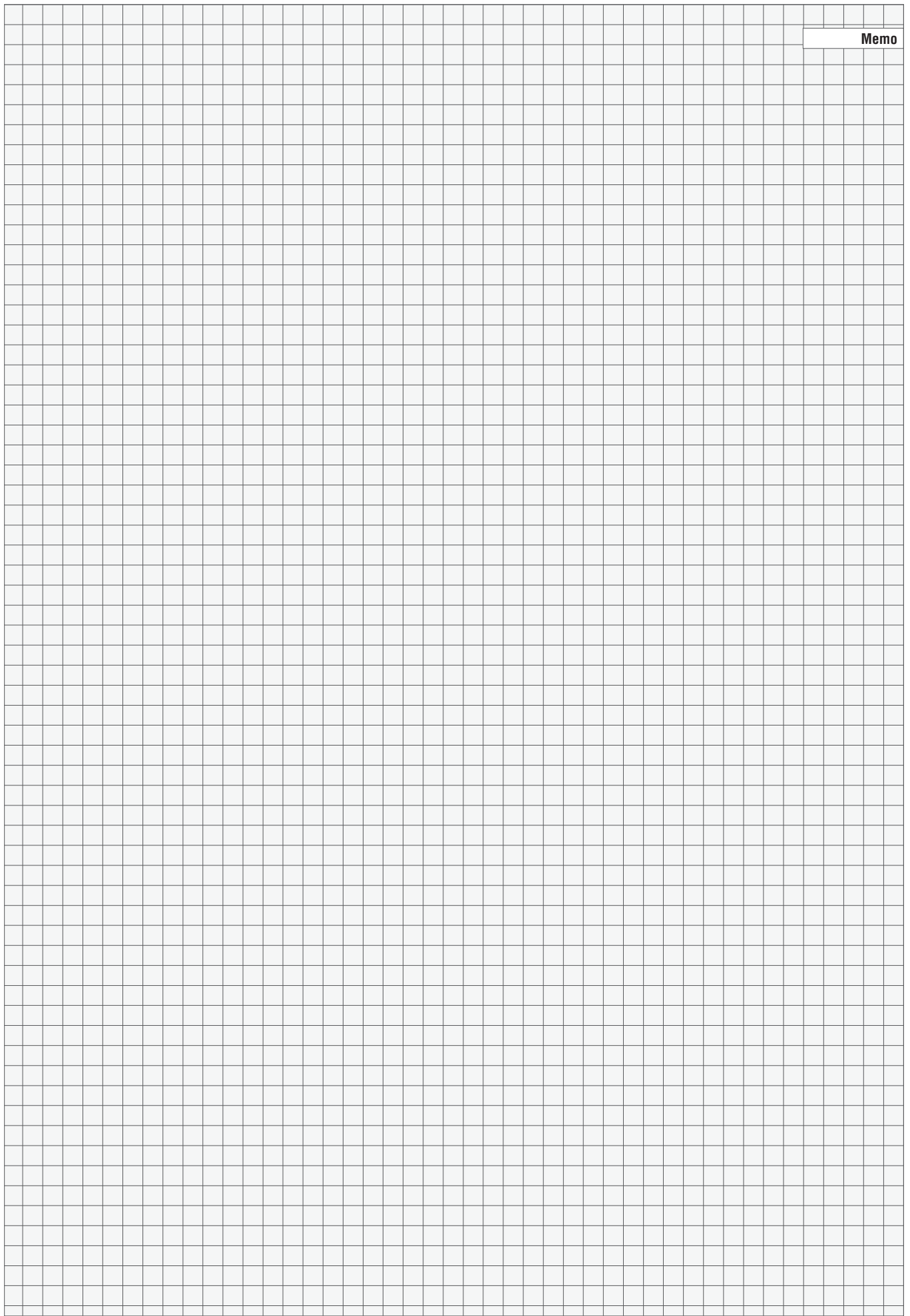

# 12

## Fastening tools Narzędzia do łączenia



**Hand riveters & rivets**  
Nitownice ręczne i nity

236-238



**Mini palm nailers**  
Młotki pneumatyczne do gwoździ

241



**Hand riveters**

Nitownice ręczne..... 236

Lazy tong riveters..... 236

Nitownice ręczne, dźwigniowe..... 236

**Hand nut tools**

Nitownice do nitonakrętek..... 237

**Aluminium blind rivets**

Nity aluminiowe..... 238

**Pneumatic riveters**

Nitownice pneumatyczne

238



**Gas framing nailers & accessories**  
Gwoździarki gazowe i akcesoria

241



**Foam guns**

Pistolety do pianki

242



**Caulking guns**

Wyciskacze do mas

243



**Staple guns & staples**

Zszywacze i zszywki

239



**Burners & soldering tools**

Palniki i lutownice

244-246



**Staple guns**

Zszywacze..... 239

**Staple removers**

Rozszywacze..... 239

**Staples**

Zszywki..... 239

**Nails**

Gwoździe..... 239

**Glue guns**

Pistolety do klejenia

247



**Pneumatic stitching & nailing machines**

Zszywacze i gwoździarki pneumatyczne

240-241



**Pneumatic staplers**

Zszywacze pneumatyczne..... 240

**Pneumatic nailers**

Gwoździarki pneumatyczne..... 240

**Staples**

Zszywki..... 241

**Nails**

Gwoździe..... 241

- |                        |                            |
|------------------------|----------------------------|
| GB Hand rive er        | RO Presă de nituit manuală |
| D Blindnietzange       | F Riveteuse manuelle       |
| PL Nitownica ręczna    | I Rivettatrice manuale     |
| RUS Заклепочник        | E Remachadora de mano      |
| CZ Ruční nýtovačka     | CN 拉铆枪                     |
| H Kézi pöpszegecszhúzó |                            |



STAINLESS STEEL, STEEL, ALUMINIUM  
STAL, NERDZEWNIA, STAL, ALUMINIUM

x4

3 JAWS  
3 SZCZĘKI

CrV

DOUBLE BLISTER

YATO	Ø (mm)	L (mm)	
YT-3600	2.4; 3.2; 4.0; 4.8	280	6/24

- |                        |                            |
|------------------------|----------------------------|
| GB Hand rive er        | RO Presă de nituit manuală |
| D Blindnietzange       | F Riveteuse manuelle       |
| PL Nitownica ręczna    | I Rivettatrice manuale     |
| RUS Заклепочник        | E Remachadora de mano      |
| CZ Ruční nýtovačka     | CN 拉铆枪                     |
| H Kézi pöpszegecszhúzó |                            |

STAINLESS STEEL, STEEL, ALUMINIUM  
STAL, NERDZEWNIA, STAL, ALUMINIUM

x4

3 JAWS  
3 SZCZĘKI

CrMo

200 mm



COLOR BOX

YATO	Ø (mm)	L (mm)	
YT-36012	2.4; 3.2; 4.0; 4.8	200	30

- |                        |                            |
|------------------------|----------------------------|
| GB Hand rive er        | RO Presă de nituit manuală |
| D Blindnietzange       | F Riveteuse manuelle       |
| PL Nitownica ręczna    | I Rivettatrice manuale     |
| RUS Заклепочник        | E Remachadora de mano      |
| CZ Ruční nýtovačka     | CN 拉铆枪                     |
| H Kézi pöpszegecszhúzó |                            |

STAINLESS STEEL, STEEL, ALUMINIUM  
STAL, NERDZEWNIA, STAL, ALUMINIUM

3 JAWS  
3 SZCZĘKI

CrV

253 mm



SLIDING CARD

YATO	Ø (mm)	L (mm)	
YT-36011	2.4; 3.2; 4.0; 4.8	253	12/36

- |                            |                                  |
|----------------------------|----------------------------------|
| GB Lazy tongue riveter     | F Riveteuse à levier             |
| D Blindnietzange           | I Rive a rice er rive i a s ra o |
| PL Nitownica dźwigniowa    | E Remachadora de palanca         |
| RUS Заклепочник            | CN 双把手拉铆枪                        |
| CZ Nýtovačka páková        |                                  |
| H Emeltyűs pöpszegecszhúzó |                                  |
| RO Pcleşte pt. popnituri   |                                  |



STAINLESS STEEL, STEEL, ALUMINIUM  
STAL, NERDZEWNIA, STAL, ALUMINIUM

330 mm

x5

3 JAWS  
3 SZCZĘKI

CrMo



COLOR BOX

YATO	Ø (mm)	L (mm)	
YT-3609	3.2; 4.0; 4.8; 6.0; 6.4	330	16

- |                            |                                  |
|----------------------------|----------------------------------|
| GB Lazy tongue riveter     | F Riveteuse à levier             |
| D Blindnietzange           | I Rive a rice er rive i a s ra o |
| PL Nitownica dźwigniowa    | E Remachadora de palanca         |
| RUS Заклепочник            | CN 双把手拉铆枪                        |
| CZ Nýtovačka páková        |                                  |
| H Emeltyűs pöpszegecszhúzó |                                  |
| RO Pcleşte pt. popnituri   |                                  |



STAINLESS STEEL, STEEL, ALUMINIUM  
STAL, NERDZEWNIA, STAL, ALUMINIUM

328 mm

3 JAWS  
3 SZCZĘKI

CrMo

COLOR BOX

YATO	Ø (mm)	L (mm)	
YT-36092	3.2; 4.0; 4.8; 6.4	328	12

- GB Lazy tongue riveter  
D Blindnietzange  
PL Nitownica dźwigniowa  
RUS Заклепочник  
CZ Nýtovačka páková  
H Emeltyűs  
RO Pclește pt. popnituri
- F Riveteuse à levier  
I Rive a rice er rive i  
a s r a o  
E Remachadora de palanca  
CN 双把手拉铆枪



380  
mm

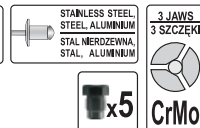

COLOR BOX

YATO	Ø (mm)	L (mm)	
YT-36095	2.4; 3.2; 4.0; 4.8; 6.4	380	12

- GB Lazy tongue riveter  
D Blindnietzange  
PL Nitownica dźwigniowa  
RUS Заклепочник  
CZ Nýtovačka páková  
H Emeltyűs  
RO Pclește pt. popnituri
- F Riveteuse à levier  
I Rive a rice er rive i  
a s r a o  
E Remachadora de palanca  
CN 双把手拉铆枪



525  
mm



COLOR BOX

YATO	Ø (mm)	L (mm)	
YT-3610	3.2; 4.0; 4.8; 6.0; 6.4	525	12

- GB Hand nut tool  
D Blindnietzange  
PL Nitownica ręczna do nitonakrętek  
RUS Заклепочник  
CZ Nýtovačka páková  
H Emeltyűs popszegecsűző  
RO Pclește pt. popnituri
- F Riveteuse manuelle aux écrous  
I Rivettatrice mano rivetto  
E Remachadora de palanca  
CN 手动铆螺母枪



0~8  
mm



COLOR BOX

YATO	size / rozmiar	L (mm)	
YT-3613	M4 M5 M6 M8 M10	440	10

- GB Hand nut tool  
D Blindnietzange  
PL Nitownica ręczna do nitonakrętek  
RUS Заклепочник  
CZ Nýtovačka páková  
H Emeltyűs popszegecsűző  
RO Pclește pt. popnituri
- F Riveteuse manuelle aux écrous  
I Rivettatrice mano rivetto  
E Remachadora de palanca  
CN 手动铆螺母枪



330  
mm



BMC  
& COLOR  
SLEEVE

YATO	size / rozmiar	L (mm)	
YT-3612	M3 M4 M5 M6 M8 M10	330	5

GB Hand nut tool  
D Blindnietzange  
PL Nitownica ręczna do nitonakrętek  
RUS Заклепочник  
CZ Nýtovačka páková  
H Emeltyűs popszegecsűző  
RO Pclește pt. popnituri

F Riveteuse manuelle aux écrous  
I Rivettatrice mano rivetto  
E Remachadora de palanca  
CN 手动铆螺母枪



YATO	size / rozmiar	L (mm)	
YT-36119	M5 M6 M8 M10 M12	338	6

GB Hand nut tool  
D Blindnietzange  
PL Nitownica ręczna do nitonakrętek  
RUS Заклепочник  
CZ Nýtovačka páková  
H Emeltyűs popszegecsűző  
RO Pclește pt. popnituri

F Riveteuse manuelle aux écrous  
I Rivettatrice mano rivetto  
E Remachadora de palanca  
CN 手动铆螺母枪



YATO	size / rozmiar	L (mm)	
YT-36129	M3 M4 M5 M6 M8 M10 M12	410	5

GB Aluminium blind rivets  
D Aluminiumblindnieten  
PL Nity aluminiowe  
RUS Алюминиевые заклёпки

CZ H in kov ný  
H Alu popszegecs  
RO Nituri din aluminiu  
F Rivets en aluminium

I Alluminio rivetti  
E Remaches de aluminio  
CN K型抽芯铝铆钉



50 PCS  
AI



YATO	Ø (mm)	L (mm)	PCS packing	
YT-3635	4.0	9.6	50	12/48
YT-3636	4.0	12.7	50	12/48

12

GB Pneumatic riveting machine  
D Pneumatische Nietvorrichtung  
PL Nitownica pneumatyczna  
RUS Пневматический заклёпочник  
CZ Pneumatická nýtovačka  
H Pneumatikus popszegecsűző

RO Presa pneumatica de nituti  
F Riveuse pneumatique  
I Rivettatrice pneumatica  
E Máquina remachadora  
CN 气动拉铆枪

COLOR BOX



x4 • application: industr  
• przeznaczenie: przemysł

x5 • application: industr  
• przeznaczenie: przemysł

YATO	Ø (mm)	L (mm)	F (kg)	F (N)	
YT-3617	2.4; 3.2; 4.0; 4.8	14	850	8335	10

YATO	Ø (mm)	L (mm)	F (kg)	F (N)	
YT-3618	2.4; 3.2; 4.0; 4.8; 6.4	16	1389	13620	6

GB Staple gun  
D Tacker  
PL Zsz wacz a icerski  
RUS Crennep  
CZ Čalounická sešivačka  
H Kárpitos tűzőgép  
RO Ca sa or a ierie

F Agrafeuse a issier  
I Cucitrice per a ezzerie  
E Grapadora de a icero  
CN 打钉枪

DOUBLE BLISTER

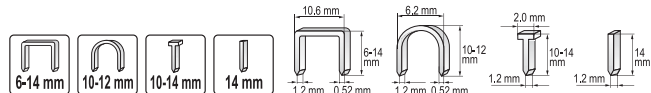
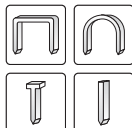

**YATO**

YT-7000

12/24

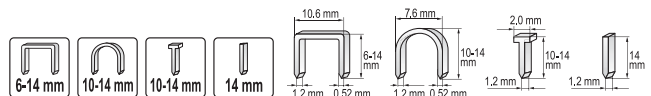

**YATO**

YT-7001

12/24

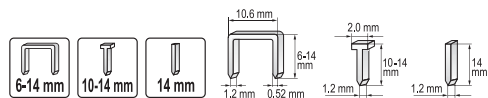

**YATO**

YT-7003

6/24

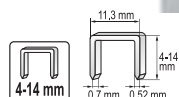

**YATO**

YT-7007

12/24

GB Staple gun  
D Tacker  
PL Zsz wacz a icerski  
RUS Crennep  
CZ Čalounická sešivačka  
H Kárpitos tűzőgép  
RO Ca sa or a ierie

F Agrafeuse tapisser  
I Cucitrice er a ezzerie  
E Grapadora de a icero  
CN 打钉枪



DOUBLE BLISTER

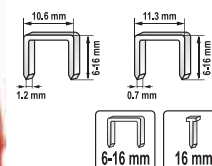

**YATO**

staples size / rozmiar zszywek (mm)

YT-7005

10.6x6.0-16.0x1.2

6/24

GB Hammer tacker  
D Hammer-Tacker  
PL Zszywacz młotkowy  
RUS Crennep

CZ Čalounická sešivačka  
H Kárpitos tűzőgép  
RO Ca sa or a ierie  
F Agrafeuse tapisser

I Martello cucitrice  
E Grapadora de martillo  
CN 钉锤



DOUBLE BLISTER

**YATO**

YT-7004

10/20

GB Staple remover  
D Klammern abwender  
PL Rozsz wacz  
RUS Скобуудалитель  
CZ Rozešivač  
H Ka ocskiszedő  
RO rac or ca se  
F Degrafeuse  
I Fiocco di rimozione  
E Quitagrapas  
CN 起钉器



SLIDING CARD

**YATO**

YT-7011

25/100

GB Sa es  
D Heftklammern  
PL Zsz wki  
RUS Скобы

CZ Sešivky  
H Tűzőkapocs  
RO Ca se a ierie  
F Agrafes

HANGING COLOR BOX



for / dla: YT-7000, YT-7001, YT-7003, YT-7004, YT-7005

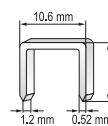

YATO L (mm)	PCS packing:	
YT-7022	6	1000 50/200
YT-7023	8	1000 50/200
YT-7024	10	1000 50/100
YT-7025	12	1000 50/100
YT-7026	14	1000 50/100



for / dla: YT-7006, YT-7007

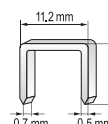

YATO L (mm)	PCS packing:	
YT-7051	6	1000 60/360
YT-7052	8	1000 60/300
YT-7053	10	1000 60/240
YT-7054	12	1000 50/200
YT-7055	14	1000 40/160

GB Nails for staple gun  
D Nageln für Yato Tacker  
PL Gwoździe do zszywacza  
RUS Гвозди для степлера  
CZ Hřebíky na sešivačku  
H Szegeka tűzőgéphez  
RO Cuie pt. capsator  
F Clous pour agrafeuses  
I Chiodi per cucitrice  
E Clavos para grapadoras  
CN 直钉



HANGING COLOR BOX



for / dla: YT-7000, YT-7001

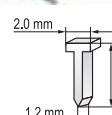

YATO L (mm)	PCS packing:	
YT-7032	10	1000 50/200
YT-7033	12	1000 50/200
YT-7034	14	1000 50/200

- GB Pneumatic stitching machine
- D Drucklufthefter
- PL Zszywacz pneumatyczny
- RUS Пневматический шиватель
- CZ Pneumatická sešíváčka
- H Pneumatikus tűzőgép
- RO Capsator pneumatic
- F Agrafeuse pneumatique
- I Cucitrice pneumatica
- E Engrapadora pneumática
- CN 气动码钉枪

7 bar 8-25 mm 1/4" 6.3mm

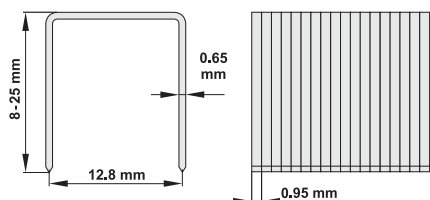

- application: industr , construction
- przeznaczenie: przemysł, budownictwo



BMC & COLOR SLEEVE

<b>YATO</b>	
YT-0920	5

- GB Pneumatic nailing machine
- D Druckluftnagelgerät
- PL Gwoździarka pneumatyczna
- RUS Пневматическая гвоздильная машина
- CZ Pneumatický nastřelovač hřebíků
- H Pneumatikus szögbelövő
- RO Capsator pneumatic
- F Cloueur pneumatique
- I Chiodatrice pneumatica
- E Maquina pneumática para clavar clavos
- CN 气动码钉枪

8 bar 25-64 mm 90° 1/4" 6.3mm

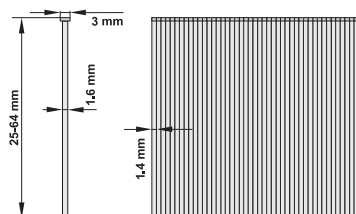

- application: industr , construction
- przeznaczenie: przemysł, budownictwo



BMC & COLOR SLEEVE

<b>YATO</b>	
YT-0921	5

- GB Pneumatic nailing machine
- D Druckluftnagelgerät
- PL Gwoździarka pneumatyczna
- RUS Пневматическая гвоздильная машина
- CZ Pneumatický nastřelovač hřebíků
- H Pneumatikus szögbelövő
- RO Capsator pneumatic
- F Cloueur pneumatique
- I Chiodatrice pneumatica
- E Maquina pneumática para clavar clavos
- CN 气动码钉枪

8 bar 50-90 mm 34° 1/4" 6.3mm

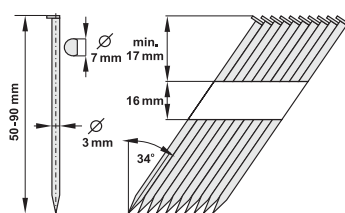

- application: industr , construction
- przeznaczenie: przemysł, budownictwo



BMC & COLOR SLEEVE

<b>YATO</b>	
YT-0923	2



GB Sa es  
D Heftklammern  
PL Zsz wki  
RUS Скобы  
CZ Sešivky  
H Tűzőkapocs

RO Ca se  
a ierie  
F Agrafes  
I Punti  
E Grapas  
CN 码钉

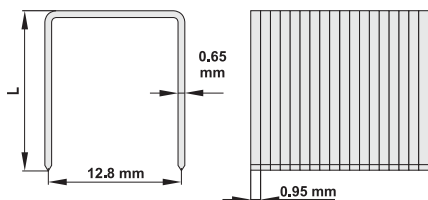

for / dla: YT-0920 COLOR BOX



1000  
PCS

YATO	L (mm)	
YT-0930	8	100
YT-0931	16	50
YT-0932	25	50

GB Nai s  
D Nägel  
PL Gwoździe  
RUS Гвозди

CZ Hřebíky  
H Szeg  
RO Cuie  
F Clous



for / dla: YT-0921

1000  
PCS 90°



YATO	L (mm)	
YT-0941	50	20
YT-0942	64	20

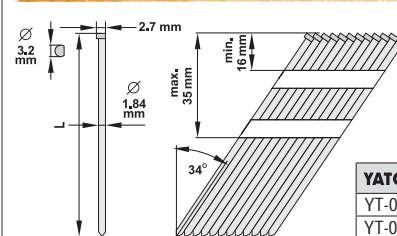

1000  
PCS 34°



YATO	L (mm)	
YT-0938	38	20
YT-0939	50	20
YT-0940	64	20

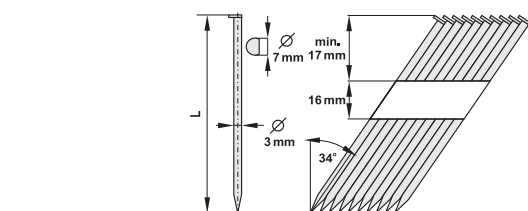

500  
PCS 34°



YATO	L (mm)	
YT-0935	50	10
YT-0936	75	10
YT-0937	90	10

for / dla: YT-0923, YT-0927

GB Mini palm nailer  
D Drucklufthammer für nagel  
PL Młotek pneumatyczny do gwoździ  
RUS Пневматический молоток для забивания гвоздей  
CZ Pneumatická hřebíkovačka  
H Pneumatikus szögbeütő kalapács  
RO Ciocan pneumatic pt. cuie  
F Cloueur pneumatique  
I Chiodatrice pneumatica  
E Maquina pneumática para cavar c avos  
CN 迷你气动钉枪

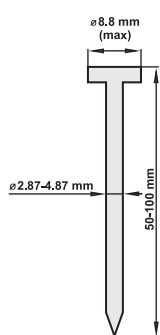

0.70  
MPa 1/4" 6.3 mm



COLOR BOX

YATO	
YT-0925	20

GB Gas framing nailer  
D Gas-nagler  
PL Gwoździarka gazowa  
RUS Газовая гвоздильная машина  
CZ Plynová nastřelovačka hřebíků  
H Gáztechnológiás szögbeütő

RO Capsator cu gaz  
F Cloueur à gaz  
I Chiodatrice a gas  
E Clavadora de gas  
CN 瓦斯钉枪

42 bar 4000l 50-90 mm 40 g 80 ml 1200l TRIGGER LOCK BLOKADA SPUSZTU

GB Gas pipe  
D Gaspatrone  
PL Tuba gazowa  
RUS Баллончик с газом  
CZ Plynová bombička  
H Gáz patron  
RO Recipient cu gaz  
F Cartouche de gaz pour cloueur  
I Chiodatrici a gas  
E Tubo de gas  
CN 瓦斯管配件

40 g 80 ml FUEL CELL FOR NAILERS DO GWOŹDZIAREK

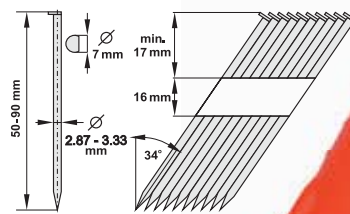

fits to / pasuje do:  
YATO, PASLODE,  
HITACHI, Senco,  
POWERS, MAX, BEA

BMC & COLOR SLEEVE



YATO	
YT-0927	2

YATO	
YT-0929	20/200

GB Foam gun  
 D Farbs ritz is o e  
 PL Pistolet do pianki montażowej  
 RUS Пистолет для нанесения полиуретановой пены  
 CZ Pistole na montážní pěnu  
 H Felrakó pisztoly, poliurethán habhoz  
 RO Pistol pt. spumă

F Pistolet mousse expansive  
 I Pistola per schiuma poliuretanică  
 E Pistola para espuma de montaje de metal  
 CN 发泡枪

COLOR BOX



**PTFE  
 COATED**



**YATO**    
 YT-6740 10/20



**YATO**    
 YT-6741 10/20



**YATO**    
 YT-6742 10/20



**YATO**    
 YT-6743 20





**YATO**    
 YT-6745 20

300 ml

GB Caulking gun CZ Protlačovač na hmoty I Pistola a er si cone  
D Kartuschenpistole H Masszakinyomó E Pistola para masilla  
PL Wyciskacz do mas RO Pistoli con CN 堵缝枪  
RUS Пистолет для герметика F Pistolet à feutrer





225 mm

<b>YATO</b> 	L (mm)	
YT-6751	225	10/20





225 mm

<b>YATO</b> 	L (mm)	
YT-6752	225	10/20





225 mm

<b>YATO</b> 	L (mm)	
YT-6753	225	6/12





225 mm

<b>YATO</b> 	L (mm)	
YT-6754	225	10/20





225 mm

<b>YATO</b> 	L (mm)	
YT-6750	225	20/40





225 mm

<b>YATO</b> 	L (mm)	
YT-6755	225	10/20



216 mm  
±60 mm

<b>YATO</b> 	L (mm)	
YT-6756	215	6/12



200 mm  
±65 mm

<b>YATO</b> 	L (mm)	
YT-6757	200	10/20

GB Gas torch  
D Gasbrenner  
PL Palnik gazowy  
RUS Газовая паяльная  
лампа  
CZ Plynový hořák  
H Gázégő

RO Arzător de gaz  
F Bruleur à gaz  
I Saldatore bruciatore  
a gas  
E Soplete de gas  
CN 火焰枪



**YATO**  
YT-6700 6/24

GB Gas torch  
D Gasbrenner  
PL Palnik gazowy  
RUS Газовая паяльная  
лампа  
CZ Plynový hořák  
H Gázégő

RO Arzător de gaz  
F Bruleur à gaz  
I Saldatore bruciatore  
a gas  
E Soplete de gas  
CN 火焰枪

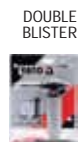
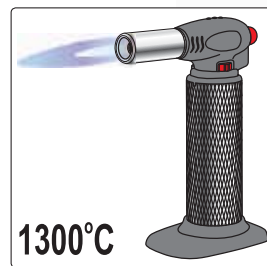

**YATO**  
YT-36700 10/20

GB Butane soldering tool  
D Gaslötkolben  
PL Lutownica gazowa  
RUS Паяльник газовый  
CZ P nová á ka  
H Forrasztópisztoly ceruza  
bután gáz üzemű  
RO Surubelnita sudura cu gaz  
F Fer à souder à gaz  
I Saldatore a gas  
E Microsoldador de butano portátil  
CN 瓦斯焊接工具



SLIDING  
CARD

**YATO**  
YT-6705 25-80 12/72

GB Soldering tool set  
D Gaslötkolben satz  
PL Lutownica gazowa z akcesoriami  
RUS Газовый паяльный набор  
CZ Plynova pajka souprava  
H Gaz forrasztópáka készletek

RO Set ciocan de lipit cu gaz  
F Fer à souder à gaz  
I Saldatore a gas  
E Soldador a gas con accesorios  
CN 自动点火多功能瓦斯组套

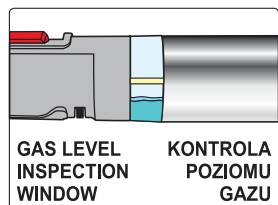
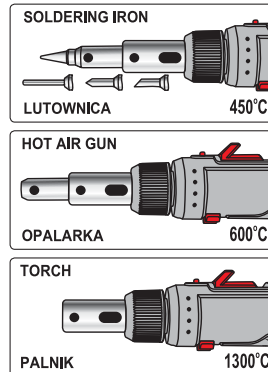
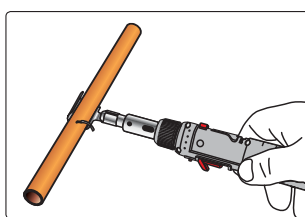

PLASTIC BOX  
& HANGING  
COLOR BOX

**YATO**  
YT-36706 30-125 6

GB Butane soldering tool  
D Gaslötkolben  
PL Lutownica gazowa  
RUS Паяльник газовый  
CZ P nová á ka  
H Forrasztópisztoly ceruza bután gáz üzemű

RO Surubelnita sudura cu gaz  
F Fer à souder à gaz  
I Saldatore a gas  
E Microso dador de butano portátil  
CN 瓦斯焊接工具

PIEZO ELECTRIC 1300°C 250-550°C 38 ml 30-125 W 200 min



SLIDING CARD

**YATO**  
YT-6706 30-125 12/48

GB Soldering tool 3 in 1  
D Gaslötkolben 3 in 1  
PL Lutownica gazowa 3 w 1  
RUS Газовый паяльник 3-в-1  
CZ P nova á ka 3 in 1  
H Gaz-forrasztópaka 3 in 1  
RO Ciocan de lipit cu gaz 3 in 1

F Fer à souder à gaz  
I Saldatore a gas  
E Soldador de gas 3 in 1  
CN 瓦斯焊接工具

PIEZO 30~70 W 12 ml 60 min GAS GAZ LOCK BLOKADA BUTANE lighter gas PROPANE-BUTANE lighter gas CHILD PROTECTION ZABEZPIECZENIE PRZED DZIECIAMI

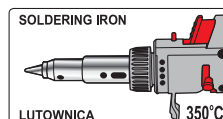

SOLDERING IRON 350°C

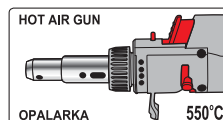

HOT AIR GUN 550°C

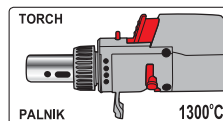

TORCH 1300°C

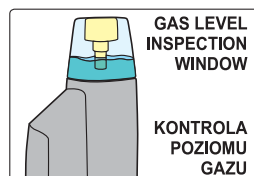

GAS LEVEL INSPECTION WINDOW

KONTROLA POZIOMU GAZU



SLIDING CARD

**YATO**  
YT-36704 30-70 12/72

GB Gas blow torch  
D ò brenner  
PL Palnik gazowy  
RUS Газовая горелка  
CZ Plynový hořák  
H Gázégó

RO Arzător de gaz  
F Bruleur à gaz  
I Saldatore bruciatore a gas  
E Soplete de gas  
CN 火焰枪

PIEZO 1.28 kW GAS GAZ AIR POWETRZE LOCK BLOKADA BUTANE BUTAN

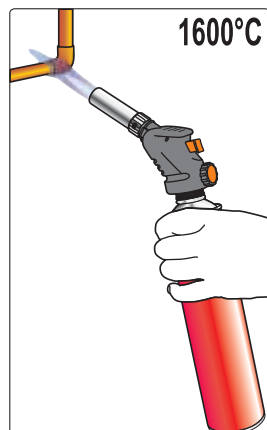

1600°C

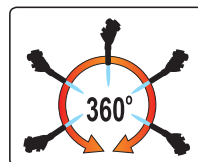

EURO TYPE EN417



SLIDING CARD

**YATO**  
YT-36709 1.28 6/12

GB Soldering iron  
 D ò koben  
 PL Lutownica orogowa  
 RUS Электропаяльник  
 CZ Pá ka od ogová  
 H Forraszó áka  
 RO Ciocan de i i  
 F Fer à souder  
 I Saldatore a stagno  
 E So dador de resis encia  
 CN 电烙铁



HANGING DISPLAY  
 COLOR BOX



230V~  
 50Hz

YATO	working temp. of soldering tip (°C)		dimensions of soldering tip (mm)	
YT-8271	30	400	ø3.8 x 70	16
YT-8272	60	500	ø6.0 x 78	16
YT-8273	80	520	ø6.8 x 64	16

GB Desoldering pump  
 D Entlötsaugpumpe  
 PL Odszacz do c n  
 RUS Шприц для удаления припоя  
 CZ Odrájecí sací pumpa  
 H nszi an ó

RO Pompa fluidor  
 F Pompe à étain  
 I Pompa aspira stagno  
 E Bomba desoldadora  
 CN 全铝手动吸锡器

SLIDING CARD



PTFE TIP



YATO  
 YT-82742 100/400



YATO  
 YT-82743 100/200



YATO  
 YT-82744 50/100

GB Transformer soldering gun  
 D ò is oe  
 PL Lutownica transformatorowa  
 RUS Паяльник электрический  
 CZ Transformátorová páječka  
 H Forraszó áka  
 RO ara de i id e con cu transformator

F Fer à souder  
 I Sa da ore is ane o  
 E Soldador transformador  
 CN 电烙铁

230V~  
 50Hz

180  
 W



LED



BMC & COLOR SLEEVE



YATO  
 YT-8245 180 10

GB Soldering station  
 D ò s a ion  
 PL Stacja lutownicza  
 RUS Паяльная станция  
 CZ e ovac s anice  
 H Forrasztópáka állomás

RO Stație de lipit  
 F Station de soudage  
 I Stazione digitale di saldatura  
 E Estación de soldadura  
 CN 数显焊台

230V~  
 50Hz

48W

150-450  
 °C

7.1 mm  
 65 mm

LCD DISPLAY

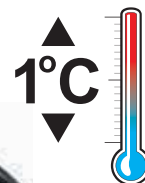

COLOR BOX



YATO  
 YT-82455 48 4

GB Electric glue gun  
D Heißklebeisole  
PL Pistolet do klejenia  
RUS Пистолет для клея  
CZ Pistolet na lepen  
H Ragasztópisztoly  
RO Pistol pt. lipit  
F Pistolet à colle  
I Pistoletta  
E Pistola de cola  
CN 热胶枪

230V~50Hz 35 (400) W 11 mm 



COLOR BOX

**YATO** 

YT-82401

35 (400)



12/24

GB Cordless glue gun  
D Heißklebeisole  
PL Akumulatorowy pistolet do klejenia  
RUS Пистолет для клея  
CZ Pistolet na lepen  
H Ragasztópisztoly  
RO Pistol pt. lipit  
F Pistolet à colle  
I Pistoletta  
E Pistola de cola  
CN 热胶枪

7.4 V 2.6 Ah Li-Ion  8W 11 mm 



DOUBLE BLISTER

**YATO** 

YT-82421

8



6/24

Memo

# 13

## Construction tools Narzędzia budowlane





Floor laminate cutters  
Gilotyny do cięcia paneli podłogowych

250 

Floating rules  
Łaty

258 

Tile cutting machines & accessories  
Przyrządy do cięcia glazury i akcesoria

250-252 

Knives  
Noże

258 

Profile gauges  
Wzorniki profili

253 

Electric hoists  
Elektryczne wciągarki linowe

259 

Scrapers  
Szpachelki

253 

Extension cords  
Przedłużacze elektryczne

260-261 

Masonry tools  
Narzędzia tynkarskie i murarskie

254-255 

Mixers  
Mieszadła

262 

Floats  
Pace..... 254  
Trowels  
Kielnie..... 255  
Plaster scrubbers  
Żdzieraki do tynków..... 255

Pencils  
Ołówki

262-263 

Roofwork tools  
Narzędzia dekarские

256-257 

Carpenter's pencils  
Ołówki stolarskie..... 262  
Masonry pencils  
Ołówki murarskie..... 262

GB Floor laminate cutter  
 D Laminat-Schneider  
 PL Gilotyna do cięcia paneli podłogowych  
 RUS Гильотина для ламината  
 CZ Nůžky na laminátové plovoucí podlahy

H Laminált padló vágógép  
 RO Aparat de taiat parchet laminat  
 F Guillotine pour couper les panneaux  
 I Ghigliottina per taglio dei pannelli  
 E Guillotina cortapaneles  
 CN 木地板切割器

CARBON STEEL STAL WĘGLOWA  
**12 max.** CUTTING THICKNESS mm GRUBOŚĆ CIĘCIA  
 ZINC PLATED CYNKOWANIE  
**205 max.** CUTTING LENGTH mm DŁUGOŚĆ CIĘCIA

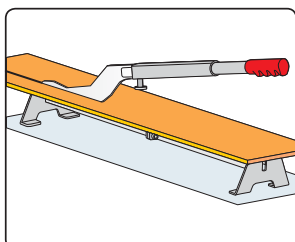
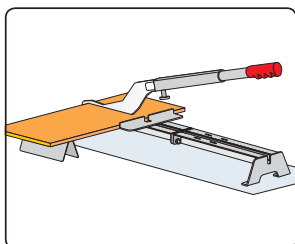
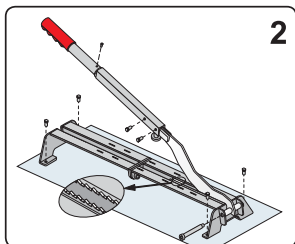
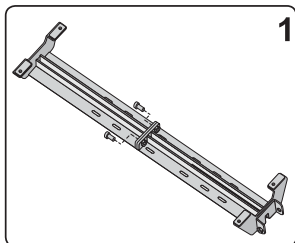

COLOR BOX

<b>YATO</b>		
YT-3730		4

13

GB Tile cutting machine  
 D Fliesenschneidmaschine  
 PL Przystroj do cięcia glazury  
 RUS Плиткорез  
 CZ Přístroj na řezání glazury  
 H Csempevágó

RO Instrument de tăiere a glazurei  
 F Coupeuse pour la céramique  
 I Ghigliottina per taglio di piastrelle  
 E Cortadora de gres  
 CN 瓷砖切割轮



CUTTING ANGLE **±45°**  
 14 mm  
 22x8x2 mm  
 YG6X COATED TiN POWŁOKA



COLOR BOX



<b>YATO</b>	L (mm)	
YT-3701	600	2
YT-3702	700	2

GB Tile cutting machine  
D Fliesenschnidmaschine  
PL Przyrząd do cięcia glazury  
RUS Плиткопес  
CZ Přístroj na řezání glazury  
H Csempevágó

RO Instrument de tăiere a glazurei  
F Coupeuse pour la céramique  
I Ghigliottina per taglio di piastrelle  
E Cortadora de gres  
CN 瓷砖切割轮

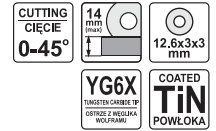

COLOR BOX



YATO	L (mm)	
YT-3703	630	2

GB Tile cutting wheel  
D Schneiderrad  
PL Kółko tnące wymienne  
RUS Ролик для плиткореза

CZ Výměnné kolečko  
H Cserérgörgő csavarral  
RO Cuțit rolă  
F Molette coupante avec barre

I Lama di ricambio tondo  
E Recambio de cuchillo redondo  
CN 硬质合金刀片

SLIDING CARD

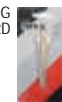

for / dla: YT-3700, YT-3701, YT-3702



for / dla: YT-3703

YATO	
YT-3712	50/250

YATO	
YT-3713	50/200

GB Tile cutting machine  
D Fliesenschnidmaschine  
PL Przyrząd do cięcia glazury  
RUS Плиткопес  
CZ Přístroj na řezání glazury  
H Csempevágó  
RO Instrument de tăiere a glazurei

F Coupeuse pour la céramique  
I Ghigliottina per taglio di piastrelle  
E Cortadora de gres  
CN 瓷砖切割轮

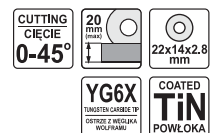

COLOR BOX



YATO	L (mm)	
YT-3704	600	1
YT-3705	900	1

GB Tile cutting machine  
D Fliesenschnidmaschine  
PL Przyrząd do cięcia glazury  
RUS Плиткопес  
CZ Přístroj na řezání glazury  
H Csempevágó

RO Instrument de tăiere a glazurei  
F Coupeuse pour la céramique  
I Ghigliottina per taglio di piastrelle  
E Cortadora de gres  
CN 瓷砖切割轮

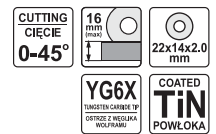

COLOR BOX



YATO	L (mm)	
YT-3706	500	2
YT-3707	600	2
YT-3708	800	2

GB Tile cutting wheel  
D Schneiderrad  
PL Kółko tnące wymienne  
RUS Ролик для плиткореза  
CZ Výměnné kolečko  
H Cserérgörgő csavarral  
RO Cuțit rolă  
F Molette coupante  
I Rotella di taglio  
E Recambio de cuchillo redondo  
CN 瓷砖切割轮



SLIDING CARD



YATO	
YT-3714	50/200

for / dla: YT-3704, YT-3705, YT-3706, YT-3707, YT-3708

GB Tile cutting pliers  
D Glasurzange  
PL Szczypce do cięcia i łamania glazury  
RUS Кусачки для плитки  
CZ Kleště do glazury

H Csempefogó  
RO Cleste rupt faianta  
F Pince grès mosaïque  
I Tenaglia per piastrelle  
E Tenazas para azulejos  
CN 瓷砖钳

200 mm YG-6X



SLIDING CARD

<b>YATO</b>	L (mm)	
YT-37160	200	6/36

GB Tile cutting pliers  
D Glasurzange  
PL Szczypce do glazury  
RUS Кусачки для плитки  
CZ Kleště do glazury  
H Csempefogó

RO Cleste rupt faianta  
F Pince grès mosaïque  
I Tenaglia per piastrelle  
E Tenazas para azulejos  
CN 瓷砖钳

215 mm 17 mm

CUT CIECIE YG6X



SLIDING CARD

<b>YATO</b>	L (mm)	
YT-37163	215	6/36

GB Tile cutting pliers  
D Glasurzange  
PL Szczypce do łamania glazury  
RUS Кусачки для плитки  
CZ Kleště do glazury  
H Csempefogó

RO Cleste rupt faianta  
F Pince grès mosaïque  
I Tenaglia per piastrelle  
E Tenazas para azulejos  
CN 瓷砖钳

200 mm 2x YG-6X COATED TiN POWLOKA



SLIDING CARD

<b>YATO</b>	L (mm)	
YT-37161	200	6/36

GB Tile cutting pliers  
D Glasurzange  
PL Szczypce do glazury  
RUS Кусачки для плитки  
CZ Kleště do glazury  
H Csempefogó

RO Cleste rupt faianta  
F Pince grès mosaïque  
I Tenaglia per piastrelle  
E Tenazas para azulejos  
CN 瓷砖钳

200 mm YG6X



SLIDING CARD

<b>YATO</b>	L (mm)	
YT-37164	200	6/60

GB Tile cutting pliers  
D Glasurzange  
PL Szczypce do glazury  
RUS Кусачки для плитки  
CZ Kleště do glazury  
H Csempefogó

RO Cleste rupt faianta  
F Pince grès mosaïque  
I Tenaglia per piastrelle  
E Tenazas para azulejos  
CN 瓷砖钳

215 mm 17 mm CUT CIECIE YG6X



SLIDING CARD

<b>YATO</b>	L (mm)	
YT-37162	215	6/36

GB Grout remover  
D Fugenreiniger  
PL Skrobak do fug  
RUS Скребок для швов кладки  
CZ Skrabák na s ár  
H Fugakihúzó

RO Răzuitoare pt. rosturi  
F Gratteur pour fugues  
I Raschietto per fuga piastrelle  
E Rascador para juntas  
CN 砂浆去除器



SLIDING CARD

<b>YATO</b>	L (mm)	
YT-37170		10/60

GB Profile gauge H Profilsablon I Profilato  
D Profilmuster RO Şablon profile E Plantilla de perfiles  
PL Wzornik profili F Jauges d'épaisseurs CN 轮廓仪  
RUS Шаблон профилей  
CZ Profilová šablona

SLIDING  
CARD



44  
mm

1.5  
mm



YATO	L (mm)	
YT-3735	125	24/72

YATO	L (mm)	
YT-3736	260	10/40

GB Scra er RUS Шпатель RO Şpaclu E Espatula  
D S ach e CZ Š ach e F Riflard CN 油灰刀  
PL Sz ache ka H Spatula I S a o a

Mn  
65



YATO	(mm)	
YT-5250	30	12/240
YT-5251	40	12/240
YT-5252	50	12/240
YT-5253	60	12/240
YT-5254	80	12/240
YT-5255	100	12/240

GB Trowe for si icone силикона F Spatule à silicone  
D Spachtel für Silikon CZ Š ach e na si ikon I S a o a er si icone  
PL Szpachelka do silikonu H S ach i szi ikonhoz E Espátula para silicona  
RUS Шпатель для RO Spatulă pt. silicon CN 橡塑刮板

TPR



HANGING  
CARD



YATO		
YT-5260		20/300



4  
PCS

SLIDING  
CARD



YATO		
YT-5261		20/200



4  
PCS

SLIDING  
CARD



YATO		
YT-5262		20/200

- GB Smooth float  
D Schweizer Glättkelle  
PL Paca gładka  
RUS Тёрка гладкая  
CZ Hlad ko rovn  
H Glettväs rozsdamentes  
RO Gletiera
- F Truelle inoxidable  
I Fra azzo iscio  
E Llana para enlucido  
CN 不锈钢砌墙刀



• made of special cold rolled stainless steel sheet with elasticity factor up to 2000 N/mm  
• części robocze ze specjalnej zimnowalcowanej blachy nierdzewnej o sprężystości do 2000 N/mm

YATO	mm	
YT-5202	270 130	30

- GB Fo a w i h e e h I Fra azzo den a o  
D Zahnke e E ana den ada  
PL Paca zębata CN 不锈钢砌墙刀  
RUS Тёрка с зубами  
CZ Hladitko zuby  
H Glettväs fogazott  
RO Gletiera zimtata  
F Truelle inoxidable



• made of special cold rolled stainless steel sheet with elasticity factor up to 2000 N/mm  
• części robocze ze specjalnej zimnowalcowanej blachy nierdzewnej o sprężystości do 2000 N/mm

YATO	teeth / zęby	mm	
YT-5202	6 6	275 130	30
YT-5203	8 8	270 130	30
YT-5204	10 10	260 130	30

- GB Smooth float  
D Schweizer Glättkelle  
PL Paca nkarska  
RUS Тёрка гладкая  
CZ Hlad ko rovn  
H Glettväs rozsdamentes  
RO Gletiera  
F Truelle inoxidable
- I Fra azzo  
E Llana para enlucido  
CN 不锈钢砌墙刀



• made of special cold rolled stainless steel sheet with elasticity factor up to 2000 N/mm  
• części robocze ze specjalnej zimnowalcowanej blachy nierdzewnej o sprężystości do 2000 N/mm

YATO	mm	
YT-5207	380 130	40
YT-5209	480 130	10
YT-5210	580 130	10

- GB Sharp ground float  
D Steinholzglätter  
PL Paca os ra  
RUS Стальная острая тёрка  
CZ Hladitko ocelové, špicaté  
H Aljzatsimitó  
RO Gletiera cu varf ascutit  
F Truelle acier  
I Frattazzo acuto  
E Llana pontiaguda  
CN 不锈钢砌墙刀



YATO	mm	
YT-5212	500	20

- GB Smooth float  
D Glättkelle  
PL Paca wenecka  
RUS Тёрка венецианская  
CZ Hlad ko rovn  
H Glettväs rozsdamentes lágy fogantyúval  
RO Gletiera  
F Truelle acier
- I Fra azzo  
E Llana puntas redondas  
CN 不锈钢砌墙刀



• made of special cold rolled stainless steel sheet with elasticity factor up to 2000 N/mm  
• części robocze ze specjalnej zimnowalcowanej blachy nierdzewnej o sprężystości do 2000 N/mm

YATO	mm	
YT-5214	200 80	20

- GB Smooth float  
D Glättkelle  
PL Paca wenecka  
RUS Тёрка венецианская  
CZ Hlad ko rovn  
H Glettväs rozsdamentes lágy fogantyúval  
RO Gletiera  
F Truelle trapézoidale
- I Fra azzo  
E Llana puntas redondas  
CN 不锈钢砌墙刀



• made of special cold rolled stainless steel sheet with elasticity factor up to 2000 N/mm  
• części robocze ze specjalnej zimnowalcowanej blachy nierdzewnej o sprężystości do 2000 N/mm

YATO	mm	
YT-5216	75 95 240	20

- GB Abrasive float "Rasp" type  
D S ro or-Sch eifbre  
PL Paca ścierna do styropianu  
RUS Шлифовальная тёрка "рашпиль"  
CZ Škrabák na orobe on  
H Csiszo ó o s iro habhöz  
RO Gletiera abraziva  
F Flotteur abrasif à styrofoam  
I Fra azzo abrasivo
- E ana abrasiva ara oie i eno  
CN 磨砂型砌墙刀



YATO	mm	
YT-5218	165 370	20

- GB Stripping knife  
D F ächens ach e  
PL Sz ach a fasadowa  
RUS Стальной шпатель  
CZ Štěrka fasádní  
H Spatulya fali (rákli)  
RO Spaclu inox  
F Spatule inoxydable
- I S a o a er faccia a  
E Espátula de fachada  
CN 剥皮刀



• made of special cold rolled stainless steel sheet with elasticity factor up to 2000 N/mm  
• części robocze ze specjalnej zimnowalcowanej blachy nierdzewnej o sprężystości do 2000 N/mm

YATO	mm	
YT-5226	250	20
YT-5228	350	20
YT-5230	500	20

- GB Aluminium float with hydrorubber  
D Alu-schwamm Brett mit Hydrogummi  
PL Paca aluminiowa z hydrogumą  
RUS Терка алюминиевая с накладкой из губчатой резины  
CZ Hladitko aluminiové s hydrogumou  
H Fugázó alumíniumtestű hidroszivacsos  
RO Gletiera de aluminiu cu hidrocauciuc  
F Truelle en aluminium avec caoutchouc  
I Frattazzo in alluminio con idrogomma  
E Talocha aluminio con hidrogoma  
CN 橡胶砌墙刀

AI

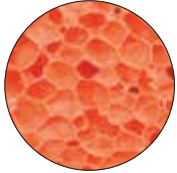
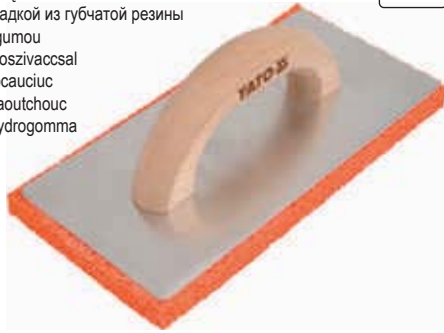

YATO	mm	
YT-5302	130 270	12

- GB Aluminium float with sponge  
D Alu-schwamm Brett mit Schwamm  
PL Paca aluminiowa z gąbką  
RUS Терка алюминиевая с накладкой из поролона  
CZ Hladitko aluminiové s hydrohoubou  
H Fugázó alumíniumtestű szivacsos  
RO Gletiera de aluminiu cu burete  
F Truelle en aluminium avec éponge  
I Frattazzo in alluminio con spugna  
E Talocha aluminio con es on a  
CN 橡胶砌墙刀

AI

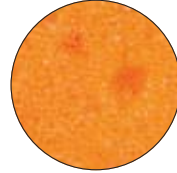
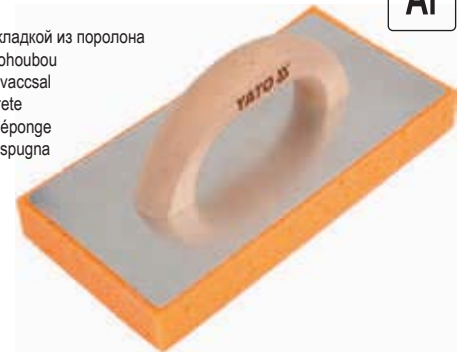

YATO	mm	
YT-5304	130 270	12

- GB Triangular trowel  
D Maurerkelle  
PL Kielnia trójkątna  
RUS Треугольный мастерок  
CZ Lžíce trojúhelníková  
H Kőműves kanál háromszögletű  
RO Mistrie triunghi  
F Truelle  
I Cazzuola punta triangolare  
E Paleta triangular  
CN 不锈钢砌墙刀

STAINLESS  
STEEL  
STAL  
NERDZEWNIA



• made of special cold rolled stainless steel sheet with elasticity factor up to 2000 N/mm  
• części robocze ze specjalnej zimnowalcowanej blachy nierdzewnej o sprężystości do 2000 N/mm

YATO	mm	
YT-5234	200 190	10

- GB Tra ezoid rove  
D Stukkateurkelle  
PL Kielnia ra ezowa  
RUS Трапецидальный мастерок  
CZ Lžíce zednická  
H Kőműves kanál rozsdamentes  
RO Mis rie  
F Truelle trapézoïdale  
I Cazzuola punta trapezio  
E Pa e a ra ezoida  
CN 不锈钢砌墙刀

STAINLESS  
STEEL  
STAL  
NERDZEWNIA



• made of special cold rolled stainless steel sheet with elasticity factor up to 2000 N/mm  
• części robocze ze specjalnej zimnowalcowanej blachy nierdzewnej o sprężystości do 2000 N/mm

YATO	mm	
YT-5237	120 180 80	10

- GB Tra ezoid rove  
D Stukkateurkelle  
PL Kielnia ra ezowa  
RUS Трапецидальный мастерок  
CZ Lžíce zednická  
H Kőműves kanál rozsdamentes  
RO Mis rie  
F Truelle trapézoïdale  
I Cazzuola punta trapezio  
E Pa e a ra ezoida  
CN 不锈钢砌墙刀

STAINLESS  
STEEL  
STAL  
NERDZEWNIA



• made of special cold rolled stainless steel sheet with elasticity factor up to 2000 N/mm  
• części robocze ze specjalnej zimnowalcowanej blachy nierdzewnej o sprężystości do 2000 N/mm

YATO	mm	
YT-5240	165 80 55	20

- GB Stucco trowel  
D Gipserspachtel  
PL Kielnia „Podkowa”  
RUS Штукатурный мастерок  
CZ Lžíce vymazávací  
H Gittelő kanál rozsdamentes  
RO Mis rie  
F Truelle en stuc  
I Cazzuola punta tonda  
E Paleta para estucado  
CN 不锈钢砌墙刀

STAINLESS  
STEEL  
STAL  
NERDZEWNIA



• made of special cold rolled stainless steel sheet with elasticity factor up to 2000 N/mm  
• części robocze ze specjalnej zimnowalcowanej blachy nierdzewnej o sprężystości do 2000 N/mm

YATO	mm	
YT-5242	100 130	20
YT-5243	80 110	20

- GB Stucco sharp trowel  
D Putzkelle  
PL Kielnia os ra  
RUS Кельма заостренная треугольная  
CZ Lžíce pokrývačská  
H Gittelő kanál rozsdamentes  
RO Mistrie cu cioc ascuțit  
F Truelle  
I Cazzuola punta acuta  
E Paleta pontiaguda  
CN 不锈钢砌墙刀

STAINLESS  
STEEL  
STAL  
NERDZEWNIA



• made of special cold rolled stainless steel sheet with elasticity factor up to 2000 N/mm  
• części robocze ze specjalnej zimnowalcowanej blachy nierdzewnej o sprężystości do 2000 N/mm

YATO	mm	
YT-5245	135 80	20

- GB Plaster scrubber  
D Alu-Rabott  
PL Zdzierak do nków  
RUS Треугольный мастерок для каменщиков  
CZ Skrabak  
H Vakolat gyalu alu késes  
RO Gletiera abraziva  
F Enleveur du badigeon  
I Utensile per sgrassare  
E Rascador para enlucido  
CN 石膏去除器

AI



YATO	mm	
YT-5247	450 90	25

GB Tin sni s  
D B echscher  
PL Nożyce do cięcia blachy  
RUS Ножницы по металлу

CZ Nůžky na plech  
H Lemezvágo olló  
RO Foarfece pt. tablă  
F Cisai e à e

I Cesoie per lamiere  
E Teras ara cha as  
CN 铁皮剪

SLIDING CARD



**DROP FORGED KUTE**

**HRC 58-61**



LEFT CUT  
CIECIE LEWE

YATO	L (mm)	cutting engt (mm)	cutting capacities (mm)				6/24
			co er	co d-ro ed s ee	hard s ee HRC35	s ain ess s ee 304	
YT-1900	260	30	0.94	0.78	0.60	0.45	6/24



RIGHT CUT  
CIECIE PRAWIE

YATO	L (mm)	cutting engt (mm)	cutting capacities (mm)				6/24
			co er	co d-ro ed s ee	hard s ee HRC35	s ain ess s ee 304	
YT-1901	260	30	0.94	0.78	0.60	0.45	6/24



LEFT CUT  
CIECIE LEWE

YATO	L (mm)	cutting engt (mm)	cutting capacities (mm)				6/24
			co er	co d-ro ed s ee	hard s ee HRC35	s ain ess s ee 304	
YT-1902	300	50	0.94	0.78	0.60	0.45	6/24



STRAIGHT CUT  
CIECIE PROSTE

YATO	L (mm)	cutting engt (mm)	cutting capacities (mm)				6/36
			co er	co d-ro ed s ee	hard s ee HRC35	s ain ess s ee 304	
YT-1925	225	52	0.94	0.78	0.60	0.45	6/36

GB Tin sni s  
D B echscher  
PL Nożyce do cięcia blachy  
RUS Ножницы по металлу  
CZ Nůžky na plech  
H Lemezvágo olló

RO Foarfece pt. tablă  
F Cisai e à e  
I Cesoie per lamiere  
E Teras ara cha as  
CN 铁皮剪



SLIDING CARD



**HRC 60-62**

**CrMo**

**90°**

SERRATED EDGES  
ZĄBKOWANA KRAWĘŻ OSTRZY



LEFT CUT  
CIECIE LEWE



RIGHT CUT  
CIECIE PRAWIE

YATO	L (mm)	cutting engt (mm)	cutting capacities (mm)				6/36
			co er	co d-ro ed s ee	hard s ee HRC35	s ain ess s ee 304	
YT-1913	225	30	0.78	0.53	0.46	0.36	6/36

YATO	L (mm)	cutting engt (mm)	cutting capacities (mm)				6/36
			co er	co d-ro ed s ee	hard s ee HRC35	s ain ess s ee 304	
YT-1914	225	30	0.78	0.53	0.46	0.36	6/36



GB Por ab e no hers  
D Schere zum Ausschneiden von Ecken  
PL Nożyce do wycinania naroży  
RUS Ножницы для наружных углов  
CZ Nůžky na vystřihování rohů  
H Sarokkivágó olló  
RO Foarfeca pt. taierea colturilor

F Ciseaux pour le coupage des coins  
I Cesoio per taglio reggetta in angoli  
E Tijera para esquinas  
CN 截角器

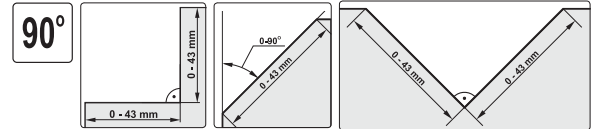

YATO	L (mm)	Box
YT-1939	300	15

GB Straight pliers  
D Zange zum Blechbiegen  
PL Kleszcze do gięcia blach  
RUS Клещи с тупым ножом для жести  
CZ Kleště na ohýbání plechu  
H Falcfogó  
RO Cleste pt. indoirea tablei  
F Pince à fléchir la tôle

I Taglie per la lamiera  
E Tenazas ara do b ar ho a a a  
CN 钣金钳



YATO	L (mm)	Box
YT-5416	280	10/20

YATO	L (mm)	Box
YT-5417	260	10/20

YATO	L (mm)	Box
YT-5415	280	10/20

GB Single seam clen  
D Klemme für Einfachfalz  
PL Zaciskacz rąbka pojedynczego  
RUS Зажим отдельного фальца  
CZ Uzavírač jednoduché drážky  
H Falclezáró fogó  
RO Clema pt. falt simplu  
F Plieur manuel tôle (rebord singulier)  
I Griffa  
E Pinza para costura individual  
CN 屋顶施工工具

GB Double seam clen  
D Klemme für Doppelfalz  
PL Zaciskacz rąbka podwójnego  
RUS Зажим двойного фальца  
CZ Uzavírač dvojité drážky  
H Duplafalclezáró fogó  
RO Clema pt. falt dublu  
F Plieur manuel tôle (rebord double)  
I Griffa  
E Pinza para costura doble  
CN 屋顶施工工具

GB Eaves turner  
D Kantvorrichtung für Dachtraufe  
PL Kantownik okapu  
RUS Угольник навеса  
CZ Ohýbačka okapnice  
H Ereszperemező fogó  
RO Cornier s reasina  
F Cintreuse d'avant-toit  
I Griffa  
E o eador de a ero  
CN 屋顶施工工具

GB aves c ench  
D Klemme für Dachtraufe  
PL Zaciskacz okapu  
RUS Зажим навеса  
CZ Uzavírač okapnice  
H Ereszperemező fogó  
RO Clema pt. streasina  
F Cintreuse d'avant-toit  
I Griffa  
E Pinza ara a ero  
CN 屋顶施工工具



YATO	Ø (mm) pipe / rurki	mm	Box
YT-5400	18	480 220	5



YATO	Ø (mm) pipe / rurki	mm	Box
YT-5402	18	480 220	5



YATO	Ø (mm) pipe / rurki	mm	Box
YT-5404	18	450 200	5



YATO	Ø (mm) pipe / rurki	mm	Box
YT-5405	18	450 200	5

GB Drain i e hooks bender  
D Biegewerkzeug für Dachrinnenhaken  
PL Zaginacz haków rynnowych  
RUS Прибор для загибания крюков для водосточных желобов  
CZ Ohýbačka okapových háků  
H reszcsa orna- ar óvas ha ó  
RO Dispozitiv pt. îndoit cârlige burlan  
F Cintreuse pour crochets de gouttière  
I Utensile per gancio  
E Herramienta para doblar los ganchos para canalones  
CN 弯管器



YATO	L (mm)	Box
YT-5410	680	4

GB Rectangular floating rule  
 D Se za e2 ibe en  
 PL Łata murarska  
 RUS Правило-уровень

CZ Lat' zednická s libelami  
 H Ólesléc, téglalap keresztmetszetű  
 RO Dreptar cu 2 bule  
 F Niveau à bulle

I ive a  
 E Nive de a ba i  
 CN 刮板



ACCURACY  
0.057"  
= 1 mm/m

2  
PRECISION  
VIALS



YATO	L (mm)	
YT-3071	1500	10
YT-3072	2000	10
YT-3073	2500	10
YT-3074	3000	10



YATO	L (mm)	
YT-3076	1500	10
YT-3077	2000	10
YT-3078	2500	10
YT-3079	3000	10

GB Trapezoid floating rule  
 D Abziehlatte mit Trapezprofil  
 PL Łata tynkarska  
 RUS Правило трапециевидное

CZ Lat' mališská  
 H Ólesléc, trapézoid keresztmetszetű  
 RO Dre ar ra ezoida  
 F Niveau à bulle

I ive a ra ezoida e  
 E Nive de a ba i  
 CN 梯形刮板



YATO	L (mm)	
YT-3081	1500	10
YT-3082	2000	10
YT-3083	2500	10
YT-3084	3000	10

GB Knife for roofing paper  
 D Messer zum Schneiden von Pappe  
 PL Nóż do cięcia papy  
 RUS Нож для резки рубероида  
 CZ Nůž k řezání lepenky  
 H Kátrányapapírvágó olló  
 RO Cutter pt. tăierea cartonului asfaltat  
 F Couteau pour carton  
 I Coltello per tagliare cartone bituminoso  
 E Cuchilla para cortar cartón alquitranado  
 CN 多功能刀



90 mm  
 STAINLESS  
 STEEL  
 STAL  
 MERCEZINA

SLIDING  
 CARD

YATO	L (mm)	
YT-7620	230	12/60

GB Knife for mineral wool  
 D Messer zum Schneiden von Bausisolierungen  
 PL Nóż do cięcia izolacji budowlanych  
 RUS Нож для резки строительной изоляции

CZ Nůž k řezání stavebních izolačních hmot  
 H Kés épületszigetelés vágásához  
 RO Cutter pt. tăierea izolațiilor  
 F Couteau pour isolants

I Coltello per tagliare l'isolamento di costruzione  
 E Cuchilla para cortar aislamiento de construcción  
 CN 多功能刀



SLIDING  
 CARD

350 mm  
 STAINLESS  
 STEEL  
 STAL  
 MERCEZINA

335 mm  
 STAINLESS  
 STEEL  
 STAL  
 MERCEZINA

YATO	L (mm)	
YT-7623	500	10/50

YATO	L (mm)	
YT-7624	480	10/50

GB Thermal knife for polystyrene foam  
 D Thermomesser für Styropor  
 PL Nóż termiczny do styropianu  
 RUS Термонож для пенопласта

CZ Termický nůž na pěnový polystyrén  
 H Polisztirol vágó hőkés  
 RO Cuțit termic pt. stiropian  
 F Couteau thermique à styrofoam

I Coltello termico per polistirolo  
 E Cuchilla térmica para poliestireno  
 CN 热切割刀

230V~  
50Hz

220  
W

70-450  
°C

POLYSTIRENE  
STIROPIAN

POLIPROPILENE  
POLIPROPILEN

PVC

LED



COLOR BOX



YATO	L (mm)	
YT-82190	220	10

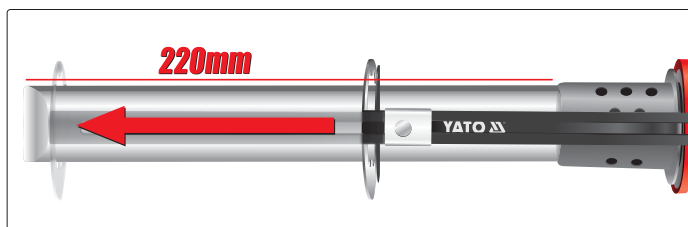
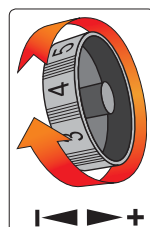

















- GB Electric hoist
- D Elektrischer Seilwinde
- PL Elektryczny wciągnik linowy
- RUS Электрическая канатная лебёдка
- CZ Elektrický navíják kádkos ro
- H Elektromos csőró
- RO Troliu electric cu cablu
- F Treuil électrique à corde
- I verrice elettrica
- E Cabria eléctrica de cuerdas
- CN 电动葫芦



COLOR BOX



<b>500 W</b>		
<b>YATO</b>		
YT-5901	2	125 kg / 250 kg
<b>550 W</b>		
<b>YATO</b>		
YT-5902	2	150 kg / 300 kg
<b>900 W</b>		
<b>YATO</b>		
YT-5904	2	250 kg / 500 kg
<b>1050 W</b>		
<b>YATO</b>		
YT-5905	2	300 kg / 600 kg

GB Rubber protection extension cord  
 D Gummiisolierte Verlängerungsschnur  
 PL Przedłużacz w osłonie gumowej  
 RUS Удлинитель с резиновой изоляцией  
 CZ Prodlužovací kabel s gumovou izolací  
 H Gumi szigetelésű hosszabbító  
 RO Cablu prelungitor cauciuc  
 F Rallonge électrique  
 I Prolunga in gomma  
 E Cable de extensión con protección de caucho  
 CN 电缆延长线

**IP44** **16A**

CABLE **H05RR-F** KABEL  
**3G1.5 mm<sup>2</sup>**  
CABLE / KABEL

**E & F** TYPE / TYP **E** TYPE / TYP

**230V~50Hz**



YATO	L (m)	
YT-81021	10	8
YT-81022	20	4
YT-81023	30	4
YT-81024	40	2

GB Rubber protection extension cord  
 D Gummiisolierte Verlängerungsschnur  
 PL Przedłużacz w osłonie gumowej  
 RUS Удлинитель с резиновой изоляцией  
 CZ Prodlužovací kabel s gumovou izolací  
 H Gumi szigetelésű hosszabbító  
 RO Cablu prelungitor cauciuc  
 F Rallonge électrique  
 I Prolunga in gomma  
 E Cable de extensión con protección de caucho  
 CN 电缆延长线

**IP44** **16A**

CABLE **H05RR-F** KABEL  
**3G2.5 mm<sup>2</sup>**  
CABLE / KABEL

**E & F** TYPE / TYP **E** TYPE / TYP

**230V~50Hz**



YATO	L (m)	
YT-8100	20	4
YT-8101	30	2
YT-8102	40	2

GB Rubber protection extension cord  
 D Gummiisolierte Verlängerungsschnur  
 PL Przedłużacz w osłonie gumowej  
 RUS Удлинитель с резиновой изоляцией  
 CZ Prodlužovací kabel s gumovou izolací  
 H Gumi szigetelésű hosszabbító  
 RO Cablu prelungitor cauciuc  
 F Rallonge électrique  
 I Prolunga in gomma  
 E Cable de extensión con protección de caucho  
 CN 电缆延长线

**IP44** **16A**

CABLE **H07RN-F** KABEL  
**3G1.5 mm<sup>2</sup>**  
CABLE / KABEL

**E & F** TYPE / TYP **E** TYPE / TYP

**230V~50Hz**



YATO	L (m)	
YT-8110	2	40
YT-8111	5	16
YT-8112	10	8

GB Rubber protection extension cord  
 D Gummiisolierte Verlängerungsschnur  
 PL Przedłużacz w osłonie gumowej  
 RUS Удлинитель с резиновой изоляцией  
 CZ Prodlužovací kabel s gumovou izolací  
 H Gumi szigetelésű hosszabbító  
 RO Cablu prelungitor cauciuc  
 F Rallonge électrique  
 I Prolunga in gomma  
 E Cable de extensión con protección de caucho  
 CN 电缆延长线

**IP44** **16A**

CABLE **H07RN-F** KABEL  
**3G1.5 mm<sup>2</sup>**  
CABLE / KABEL

**E & F** TYPE / TYP **E** TYPE / TYP

**230V~50Hz**



YATO	L (m)	
YT-8115	2	10
YT-8116	10	4
YT-81162	20	4

GB Cable reel  
D Kabeltrommel  
PL Przedłużacz zwijany  
RUS Удлинитель электрический  
CZ Bubnový prodloužovač  
H Kábe dob  
RO Prelungitor pe tambur  
F Rallonge électrique sur tambour enrouleur  
I Avvolgicavo con bobina  
E Cable de prolongación de tambor  
CN 电缆延长线



**IP44** **16A**  
CABLE **H05RR-F** **3G1.5 mm<sup>2</sup>**  
KABEL CABLE / KABEL  
E & F TYPE / TYP E TYPE / TYP  
**230V~50Hz**

•  $P_{max}$  W coiled  
 $P_{max} = 1000 W$  *zwinięty*  
•  $P_{max}$  W uncoiled  
 $P_{max} = 3000 W$  *rozwinięty*

YATO	L (m)	
YT-81052	20	2
YT-81053	30	2
YT-81054	40	2

GB Cable reel  
D Kabeltrommel  
PL Przedłużacz zwijany  
RUS Удлинитель электрический  
CZ Bubnový prodloužovač  
H Kábe dob  
RO Prelungitor pe tambur  
F Rallonge électrique sur tambour enrouleur  
I Avvolgicavo con bobina  
E Cable de prolongación de tambor  
CN 电缆延长线



**IP44** **16A**  
CABLE **H05RR-F** **3G2.5 mm<sup>2</sup>**  
KABEL CABLE / KABEL  
E & F TYPE / TYP E TYPE / TYP  
**PLASTIC REEL BEBEN PLÁSTIKOVY** **230V~50Hz**

•  $P_{max}$  W coiled  
 $P_{max} = 1200 W$  *zwinięty*  
•  $P_{max}$  W uncoiled  
 $P_{max} = 3600 W$  *rozwinięty*

YATO	L (m)	
YT-8106	30	1
YT-8107	40	1
YT-8108	50	1

GB Drum power extension cord  
D Verlängerungstrommel für Kraftstrom  
PL Przedłużacz bębnowy silowy  
RUS Силовой удлинитель барабанного типа  
CZ Prodloužovací kabel silový na bubnu  
H Háromfázisú hosszabbító dob  
RO Derulator cu tambur  
F Rallonge électrique sur tambour enrouleur  
I Avvolgicavo di forza  
E Cilindro de extensión de fuerza  
CN 电缆延长线



**IP44** **~400V ~230V**  
CABLE **H07RN-F** **5G2.5 mm<sup>2</sup>**  
KABEL CABLE / KABEL  
**3P+N+E** **3P+N+E 2x 2P+E**

• **V P E**  
 $P_{max}$  W coiled  
 $P_{max} = 1200 W$  *zwinięty*  
 $P_{max}$  W uncoiled  
 $P_{max} = 3000 W$  *rozwinięty*

• **V P N E**  
 $P_{max}$  W coiled  
 $P_{max} = 3000 W$  *zwinięty*  
 $P_{max}$  W uncoiled  
 $P_{max} = 9000 W$  *rozwinięty*

YATO	L (m)	
YT-8120	25	1

GB Cup mixer  
D Korbbrüher für klumpige, zähe Materialien  
PL Mieszadło koszykowe

RUS Краскомешалка  
CZ Košíkové míchadlo  
H Kosaras keverő  
RO Mixer pt. vopsea - tip pahar

F Malaxeur  
I Mesco a ore  
E Agitador de cesta  
CN 搅拌器



- application: powder materials, sealing compounds, gypsum surface finishing mixes, self-leveling mortars
- zastosowanie: materiały sypkie, masy uszczelniające, gładzie szpachlowe, zaprawy samopoziomujące

YATO	Ø (mm)	L (mm)	an / uchwył	max. mixing capacity / max. wydajność mieszania (kg)	
YT-5483	100	600	SDS	10-20	18

GB Spiral bar mixer  
D Rundstabrüher für klebrige, geschmeidige Materialien  
PL Mieszadło spiralne prętowe

RUS Краскомешалка  
CZ Spirálové míchadlo drátové  
H Spirális, pálcás keverő  
RO Malaxor pt. vopsea

F Malaxeur spiral  
I Mesco a ore s irá e  
E Agitadore pala/cinta  
CN 搅拌器



- application: powder materials, general purpose adhesives, gypsum surface finishing mixes, epoxy grouts
- zastosowanie: materiały sypkie, gotowe zaprawy klejowe, masy szpachlowe, zapraw do spoinowania

YATO	Ø (mm)	L (mm)	an / uchwył	max. mixing capacity / max. wydajność mieszania (kg)	
YT-5490	85	410	H X	4-9	30
YT-5491	100	600	H X	6-16	16
YT-5492	85	450	SDS	4-9	30
YT-5493	100	600	SDS	6-16	16

GB Spiral mixer  
D Rondenrüher für dünnflüssige Materialien  
PL Mieszadło spiralne

RUS Краскомешалка  
CZ Spirálové míchadlo  
H Spirális keverő  
RO Malaxor pt. vopsea

F Malaxeur spiral  
I Mesco a ore s irá e  
E Agitador de cinta helicoidal  
CN 搅拌器



- application: emulsion paints, acrylic paints, lacquers, stains, other liquid materials
- zastosowanie: farby emulsyjne, farby akrylowe, lakiery, bejce, inne materiały płynne

YATO	Ø (mm)	L (mm)	an / uchwył	max. mixing capacity / max. wydajność mieszania (kg)	
YT-5494	80	400	H X	5-10	30
YT-5496	100	600	SDS	15-30	20

GB Double spiral mixer  
D Wendelrüher für klebrige, zähe Materialien  
PL Mieszadło spiralne podwójne

RUS Краскомешалка  
CZ Spirálové míchadlo dvojité  
H Dupla spirális keverő  
RO Malaxor spirala dubla pt. vopsea

F Malaxeur spiral double  
I Mesco a ore a do ía s irá e  
E Agitador de cinta helicoidal doble  
CN 搅拌器



- application: general purpose adhesives, masonry mortars, jointless floors, thin-layer mineral plasters, gypsum surface finishing mixes, isolation masses
- zastosowanie: zaprawy klejowe, zaprawy murarskie, astrach, tynki strukturalne, masy szpachlowe, masy izolacyjne

YATO	Ø (mm)	L (mm)	an / uchwył	max. mixing capacity / max. wydajność mieszania (kg)	
YT-5497	70	400	H X	5-10	20
YT-5499	100	600	H X	10-20	16
YT-5500	120	600	H X	15-25	14
YT-5501	100	600	SDS	10-20	16
YT-5502	120	600	SDS	15-25	14
YT-5503	120	600	M14	15-25	14
YT-5504	160	600	M14	20-30	8

GB Triple spiral mixer  
D Wendelrüher für schwere, zähe Materialien  
PL Mieszadło spiralne potrójne

RUS Краскомешалка  
CZ Spirálové míchadlo trojité  
H Tripla spirális keverő  
RO Malaxor spirala tripla pt. vopsea

F Malaxeur spiral triple  
I Mesco a ore a rí o s irá e  
E Agitador de cinta helicoidal triple  
CN 搅拌器



- application: mortars, concrete, plasters, other semi-fluid materials with sand or gravel filling
- zastosowanie: zaprawy, beton, tynki, inne półpłynne, lepkie materiały z wypełnieniem piaskowym lub żwirowym

YATO	Ø (mm)	L (mm)	an / uchwył	max. mixing capacity / max. wydajność mieszania (kg)	
YT-5505	100	600	H X	10-20	16
YT-5506	120	600	SDS	15-25	12
YT-5507	120	600	M14	15-25	12
YT-5508	160	600	M14	20-30	8

GB Car er s enci  
D Zimmermannsbleistifte  
PL Ołówek stolarski  
RUS Карандаш столярный

CZ Tesařská tužka  
H Asztalos ceruza  
RO Creion de tâmplărie  
F Crayon menuisier

I Matita per falegnami  
E a iz de car in ero  
CN 木工铅笔

COLOR BOX



144 PCS HB



YATO	L (mm)	(mm)	PCS packing:	
YT-6925	245	15	144	8



YATO	L (mm)	(mm)	PCS packing:	
YT-6926	245	12	144	8

GB Masonr enci  
D Maurerbleistift  
PL Ołówek murarski  
RUS Карандаш каменщика

CZ Tužka zednická  
H Kőműves keverő  
RO Creion  
F Crayon maçon

I Matita per muratori  
E Lapiz de albañil  
CN 木工铅笔

COLOR BOX



144 PCS HB



YATO	L (mm)	(mm)	PCS packing:	
YT-6927	245	12	144	8

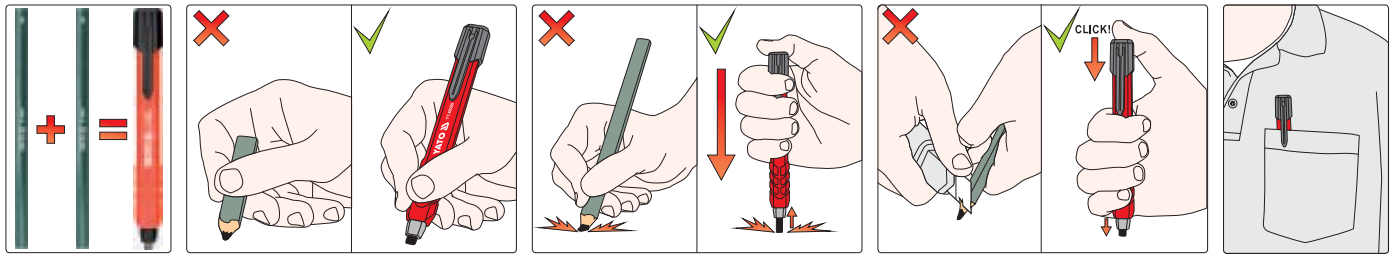

GB Automatic carpenters/masonry pencil  
D Tischler- und Maurer-Druckstift  
PL Ołówek stolarski/murarski automatyczny  
RUS Автоматический столярный карандаш/карандаш каменщика  
CZ Stolařská/zednická tužka automatická  
H Asztalos/kőműves töltőceruza

RO Creion de tâmplărie/zidărie mecanic  
F Crayon menuisier/maçon automatique  
I Matita per falegnami e carpentieri  
E Lápiz automático de carpintero/albanil  
CN 自动木工铅笔

**HB**



<b>YATO</b>	
YT-69280	50/1000

GB Automatic carpenters/masonry pencils with 5 leads  
D Tischler- und Maurer-Druckstift + zusätzliche Bleistiftmine  
PL Ołówek stolarski/murarski automatyczny + dodatkowe grafity  
RUS Автоматический столярный карандаш/карандаш каменщика + дополнительный графит  
CZ Stolařská/zednická tužka automatická + náhradní tuha

H Asztalos/kőműves töltőceruza + tartalék grafit  
RO Creion de tâmplărie/zidărie mecanic + grafit adițional  
F Crayon menuisier/maçon automatique  
I Matita per falegnami e carpentieri ricaricabile  
E Lápiz automático de carpintero/albanil + mina adicional  
CN 自动木工铅笔组套

**1+5 LEADS WKŁADY** **HB**



<b>YATO</b>	
YT-69281	144

GB lead HB  
D Bleistiftmine HB  
PL Grafit HB  
RUS Графит HB  
CZ Tuha HB  
H Grafit HB  
RO Grafit HB  
F Mine HB  
I Grafite HB  
E Mina HB  
CN 自动木工铅笔笔芯



**5 LEADS WKŁADOW** **HB**

PLASTIC TUBE



for / dla: YT-69280, YT-69281

<b>YATO</b>	
YT-69285	20/1000

GB lead H2  
D Bleistiftmine H2  
PL Grafit H2  
RUS Графит H2  
CZ Tuha H2  
H Grafit H2  
RO Grafit H2  
F Mine H2  
I Grafite H2  
E Mina H2  
CN 自动木工铅笔笔芯



**5 LEADS WKŁADOW** **H2**

PLASTIC TUBE



for / dla: YT-69280, YT-69281

<b>YATO</b>	
YT-69286	20/1000

GB lead HB  
D Bleistiftmine HB  
PL Grafit HB  
RUS Графит HB  
CZ Tuha HB  
H Grafit HB  
RO Grafit HB  
F Mine HB  
I Grafite HB  
E Mina HB  
CN 自动木工铅笔笔芯



**5 LEADS WKŁADOW** **HB** **WHITE BIAŁY**

PLASTIC TUBE



for / dla: YT-69280, YT-69281

<b>YATO</b>	
YT-69287	20/1000

# 14

## Measuring tools Narzędzia miernicze





Electric meters  
Mierniki elektryczne

266



Vernier calipers  
Suwmiarki

270



Multimeters  
Mierniki

267



Micrometers  
Mikrometry

271



Measuring tapes  
Miary zwijane

268-269



Electronic measuring tools  
Elektroniczne urządzenia pomiarowe

272



Rulers  
Przymiary

270



Levels  
Poziomnice

273



Try squares  
Kątowniki stolarskie

270



Feelers  
Szczelinomierze

273



GB Digital voltage tester  
 D Digitaler-Spannungsprüfer  
 PL Wskaźnik elektryczny  
 RUS Тестер напряжения цифровой  
 CZ Zkoušečka napětí digitální  
 H Digitális voltmérő  
 RO Tester digital pt. tensiune electrica

F Testeur de tension  
 type tournevis  
 I Cerca fase digitale  
 E Indicador e c rico  
 CN 数显测电笔

SLIDING  
 CARD



12-250  
 V  
 50-500  
 Hz  
 LCD  
 DISPLAY  
 NO BATTERY  
 NEEDED  
 NE POTREBIJE  
 BATERII



**YATO**  
 YT-2861 20/500



**YATO**  
 YT-2862 20/500



**YATO**  
 YT-2863 6/120

GB Analogue battery tester  
 D Analoges Batterieprüfgerät  
 PL Tester akumulatorów analogowy  
 RUS Аналоговый тестер аккумуляторов  
 CZ Analogový tester akumulátorů  
 H Analóg akkuteszter  
 RO Tester acumulatori analog  
 F Testeur de charge batterie  
 I Tester analogico per batteria  
 E Tester analógico para acumuladores  
 CN 电池测试器

6 V  
 12 V  
 CCA  
 200-  
 1000 A

GB Digital battery tester  
 D Digitales Batterieprüfgerät  
 PL Tester akumulatorów cyfrowy  
 RUS Цифровой тестер аккумуляторов  
 CZ Digitální tester akumulátorů  
 H Digitális akkuteszter  
 RO Tester acumulatori digital  
 F Testeur digital de charge batterie  
 I Tester digitale per batteria  
 E Tester digital para acumuladores  
 CN 电池测试器

12 V  
 LED  
 DISPLAY  
 CCA  
 150-  
 1400 A

GB Battery tester  
 D Batterieprüfgerät  
 PL Tester akumulatorów  
 RUS Тестер аккумуляторов  
 CZ Tester akumulátorů  
 H Akkuteszter  
 RO Tester acumulatori  
 F Testeur électronique de charge  
 batterie et alternateur  
 I Tester per batteria  
 E Tester para acumuladores  
 CN 电池测试器

12 V  
 BATTERY  
 TEST  
 TEST  
 AKUMULATORA  
 ALTERNATOR  
 TEST  
 TEST  
 ALTERNATORA



**YATO**  
 YT-8310 10



**YATO**  
 YT-8311 10



**YATO**  
 YT-83101 12/72

GB Digital universal multimeter  
D Universell digital Messgerät  
PL Cyfrowy miernik uniwersalny  
RUS Универсальный цифровой измеритель  
CZ Digitální multimetr univerzální  
H Digitális multiméter  
RO Multimetru digital universal  
F Multimètre numérique  
I Universale tester digitale  
E Manómetro digital universal  
CN 数字万用表

U 0-500 ~V	U 0-500 ~V	I 0-5 ~A
R 0-2 MΩ		h <sub>FE</sub> PNP NPN
	5V <sub>P-P</sub>	



**YATO**  
YT-73080 50

U 0-1000 ~V	U 0-750 ~V	I 0-10 ~A	I 0-10 ~A	R 0-20 MΩ	C 0-20 μF
	h <sub>FE</sub> PNP NPN	AUTO POWER OFF			



**YATO**  
YT-73082 30

U 0-600 ~V	U 0-600 ~V	I 0-10 ~A	I 0-10 ~A	R 0-20 MΩ	C 0-1000 μF
T -20° +1000°C		h <sub>FE</sub> PNP NPN	AUTO RANGE AUTO ZAKRES	AUTO POWER OFF	



**YATO**  
YT-73084 44

	U 0-600 ~V	U 0-600 ~V	I 0-10 ~A	I 0-10 ~A	R 0-40 MΩ
C 0-100 μF	f 100 kHz		T -20° +1000°C		AUTO RANGE AUTO ZAKRES
				AUTO POWER OFF	



**YATO**  
YT-73086 24

5 in 1 5 w 1	U 0-600 ~V	U 0-600 ~V	I 0-10 ~A	I 0-10 ~A	R 0-40 MΩ
C 0-100 μF	f 200 kHz		T -20° +1000°C		%RH 30% 90%
		AUTO RANGE AUTO ZAKRES	AUTO POWER OFF		



**YATO**  
YT-73087 24

TRUE RMS	U 0-600 ~V	U 0-600 ~V	I 0-10 ~A	I 0-10 ~A	R 0-60 MΩ
C 0-4000 μF	f 9.999 MHz		T -20° +1000°C		AUTO RANGE AUTO ZAKRES
				AUTO POWER OFF	



**YATO**  
YT-73088 20



U 0-600 ~V	U 0-600 ~V	I 0-600 ~A	R 0-200 MΩ
T -20° +1000°C		AUTO RANGE AUTO ZAKRES	AUTO POWER OFF



**YATO**  
YT-73091 20

GB Measuring tape CZ Měřicí pásmo F Ruban à mesurer E Flexómetro  
 D Rollbandmass H Mérőszalag I Misura di nastro CN 卷尺  
 PL Miara zwi ana RO Rulete din pinza  
 RUS Рулетка

3m  
16mm

5m  
19mm

AUTOMATIC  

GRADE  
II

 MAGNETIC HOOK

 NYLON COATED



3m  
16mm

5m  
25mm

8m  
25mm

SLIDING CARD



AUTOMATIC  

GRADE  
II



 MAGNETIC HOOK



 NYLON COATED



DOUBLE BLISTER



YATO 	L (m)	size / rozmiar (mm)	
YT-7103	3	16	12/120
YT-7105	5	19	12/120

YATO 	L (m)	size / rozmiar (mm)	
YT-7110	3	16	12/120
YT-7111	5	25	12/120
YT-7112	8	25	6/60

3m  
16mm

5m  
19mm

8m  
25mm

GRADE  
II

 MAGNETIC HOOK

 NYLON COATED



3m  
16mm

5m  
19mm

8m  
25mm

DOUBLE BLISTER



GRADE  
II



 MAGNETIC HOOK



 NYLON COATED



DOUBLE BLISTER



YATO 	L (m)	size / rozmiar (mm)	
YT-7116	3	16	12/120
YT-7117	5	19	12/120
YT-7118	8	25	6/60

YATO 	L (m)	size / rozmiar (mm)	
YT-7126	3	16	12/120
YT-7127	5	19	12/120
YT-7128	8	25	6/60

3m  
16mm

5m  
19mm

8m  
25mm

GRADE  
II

 MAGNETIC HOOK

 NYLON COATED



3m  
16mm

5m  
19mm

8m  
25mm

DOUBLE BLISTER







GRADE  
II



DISPLAY BOX



YATO 	L (m)	size / rozmiar (mm)	
YT-7129	3	16	12/120
YT-7130	5	19	12/120
YT-7131	8	25	6/60

YATO 	L (m)	size / rozmiar (mm)	PCS packing	
YT-71130	3	16	12	60/120
YT-71131	5	19	12	48/96
YT-71133	8	25	12	18/36

3m  
16mm

5m  
19mm

8m  
25mm

GRADE  
II



3m  
16mm

10ft  
5/8"

5m  
19mm

16ft  
3/4"

7.5m  
25mm

25ft  
1"

10m  
25mm

33ft  
1"



GRADE  
II



DOUBLE BLISTER



DOUBLE BLISTER



YATO 	L (m)	size / rozmiar (mm)	
YT-71135	3	16	12/144
YT-71136	5	19	12/72
YT-71138	8	25	8/48

YATO 	L	size / rozmiar	
YT-71141	3 m / 10 ft	16 mm / 5/8"	12/144
YT-71143	5 m / 16 ft	19 mm / 3/4"	12/96
YT-71145	7.5 m / 25 ft	25 mm / 1"	12/48
YT-71146	10 m / 33 ft	25 mm / 1"	12/36

GB Measuring tape CZ Měřicí pásmo F Ruban à mesurer E Flexómetro  
D Rollbandmass H Mérőszalag I Misura di nastro CN 卷尺  
PL Miara zwi ana RO Rulete din pinza  
RUS Рулетка

2m  
16mm

3m  
16mm

5m  
19mm

8m  
25mm

10m  
25mm

GRADE  
II

NYLON  
COATED



DISPLAY  
BOX



DOUBLE  
BLISTER



3m  
16mm

5m  
19mm

8m  
25mm

GRADE  
II

NYLON  
COATED

YATO	L (m)	size / rozmiar (mm)	PCS packing	
YT-71181	3	16	12	60/120
YT-71182	5	19	12	36/72
YT-71184	8	25	12	24/48

YATO	L (m)	size / rozmiar (mm)	
YT-71185	2	16	12/144
YT-71186	3	16	12/120
YT-71187	5	19	12/72
YT-71188	8	25	6/36
YT-71189	10	25	6/36

GB Steel measuring tape F Ruban à mesurer acier  
D Rollbandmass I Misura di nastro a acciaio  
PL Taśma miernicza stalowa E Cinta de medir de acero  
RUS Мерная лента стальная CN 长钢卷尺  
CZ Měřicí pásmo ocelové  
H Acél mérőszalag  
RO Ruleta sticla

20m  
13mm

30m  
13mm

50m  
13mm

STEEL TAPE  
TAŚMA STALOWA

SPEEDY  
RETRACTING  
SZYBSZE  
ZWIJANIE

ABS



PAPER  
HANGER



YATO	L (m)	size / rozmiar (mm)	
YT-71560	20	13	5/20
YT-71561	30	13	5/20
YT-71562	50	13	5/20

GB Fibreglass measuring tape F Ruban à mesurer  
D Rollbandmass I Misura di nastro  
PL Taśma miernicza z włókna szklanego  
RUS Мерная лента фиберглас E Cinta de medir - fibra cristal  
CZ Měřicí pásmo - skleněné vlákno CN 长纤维卷尺  
H Mérőszalag - üvegszál  
RO Ruleta fibra sticla

20m  
15mm

30m  
15mm

50m  
13mm

FIBREGLASS TAPE  
TAŚMA Z WŁÓKNA  
SZKLANEGO

SPEEDY  
RETRACTING  
SZYBSZE  
ZWIJANIE

ABS



PAPER  
HANGER



YATO	L (m)	size / rozmiar (mm)	
YT-71565	20	15	5/20
YT-71566	30	15	5/20
YT-71567	50	15	5/20

GB Steel survey tape RO Bandă de măsură pt. geodezie  
D Rollbandmass F Ruban à mesurer acier  
PL Miara geodezyjna stalowa I Nastro flessibile  
RUS Мерная лента стальная E Cinta de medir de acero  
CZ Měřicí pásmo ocelové geodetické CN 手提架式钢卷尺  
H Acél mérőszalag, geodéziai

30m  
13mm

50m  
13mm

STEEL TAPE  
TAŚMA STALOWA

ABS



COLOR BOX

YATO	L (m)	size / rozmiar (mm)	
YT-71551	30	13	10
YT-71552	50	13	10

GB Fibreglass survey tape H Mérőszalag - üvegszál  
D Rollbandmass RO Ruleta fibra sticla  
PL Miara geodezyjna F Ruban à mesurer acier  
RUS Мерная лента фиберглас I Misura di nastro in fibra di vetro  
CZ Měřicí pásmo - skleněné vlákno E Cinta de medir - fibra cristal CN 手提架式纤维卷尺

30m  
13mm

50m  
13mm

FIBREGLASS TAPE  
TAŚMA Z WŁÓKNA  
SZKLANEGO

ABS



COLOR BOX

YATO	L (m)	size / rozmiar (mm)	
YT-71555	30	13	10
YT-71556	50	13	10

GB Aluminium ruler RUS Линейка алюминиевая RO Riglă tâmplar din aluminiu E Regla de aluminiu  
 D Alu zeichen-massstab CZ Měřicí lat hliníková F Règle aluminium CN 铝合金直尺  
 PL Przymiar aluminiowy H Aszталos vonalzó, alumínium I Righello di alluminio

AI



YATO	L (mm)	
YT-7070	300	25/100
YT-7071	600	10/50

GB Aluminium try square D Anschlagwinkel PL Kałownik aluminiowy RUS Угольник столярный CZ Truhlářský úhelník H Aszталos derékszög RO Echer de tâmplărie F Equerre en aluminium I Angolo di alluminio E Escuadra de aluminio CN 铝合金角尺

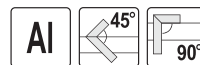

YATO	L (mm)	
YT-7080	250	6/36
YT-7081	300	6/36
YT-7082	350	6/36

GB Try square D Anschlagwinkel PL Kałownik stalowy RUS Угольник столярный CZ Truhlářský úhelník H Aszталos derékszög RO Echer de tâmplărie F Equerre I Angolo di acciaio E Escuadra CN 不锈钢角尺



STAINLESS STEEL STAL NERDZEWNA



YATO	size / rozmiar (mm)	
YT-7083	150 300	25/100
YT-7084	250 500	10/50

GB vernier caliper D Messschieber PL Suwmiarka RUS Штангенциркуль CZ Posuvné měřítko H Tolómérő RO Şubler F Pied à coulisse I Caibro E Caibre CN 游标卡尺



YATO	range / zakres (mm)	
YT-7200	0-150	10/50

GB Digital caliper D Digital Messschieber PL Suwmiarka elektroniczna RUS Штангенциркуль электронный CZ Posuvné měřítko elektronické H Elektronikus tolómérő RO Şubler electronic F Pied à coulisse électronique I Caibro e ec rónico CN 数显卡尺



YATO	range / zakres (mm)	
YT-7201	0-150	10/50

GB vernier caliper D Messschieber PL Suwmiarka RUS Штангенциркуль CZ Posuvné měřítko H Tolómérő RO Şubler F Pied à coulisse I Caibro E Caibre CN 游标卡尺

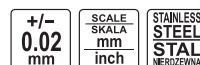



YATO	range / zakres (mm)	
YT-72003	0-200	30
YT-72004	0-300	20

- GB Micrometer
- D Mikrometer
- PL Mikrometr
- RUS Микрометр
- CZ Mikrometr
- H Mikrométer
- RO Micrometru
- F Micromètre
- I Micrometro
- E Micrómetro
- CN 外径千分尺

**+/-**  
**0.01**  
**mm**



PLASTIC CASE & COLOR BOX

YATO 	range / zakres (mm)	
YT-72300	0-25	30
YT-72301	25-50	30
YT-72302	50-75	20
YT-72303	75-100	10

- GB Micrometer with a digital display
- D Mikrometer mit Digitalanzeige
- PL Mikrometr z wyświetlaczem cyfrowym
- RUS Микрометр с цифровым индикатором
- CZ Mikrometr s digitálním displejem
- H Mikrométer digitális kijelzővel
- RO Micrometru cu afişaj digital
- F Micromètre
- I Micrometro con digitale elettronico
- E Micrómetro con pantalla digital
- CN 籽珩偌噤口煦喜

**+/-**  
**0.01**  
**mm**

SCALE  
SKALA  
**mm**  
inch

**LCD**  
DISPLAYS



PLASTIC CASE & COLOR BOX

YATO 	range / zakres (mm)	
YT-72305	0-25	20

GB Laser distance meter  
 D Laserentfernungsmesser  
 PL Dalmierz laserowy  
 RUS Лазерный дальномер  
 CZ Laserový měřič vzdálenosti  
 H Lézeres távolságmérő  
 RO Telemetru cu laser  
 F Télémètre laser  
 I Telemetro laser  
 E Medidores áser de dis ancias  
 CN 激光测距仪

COLOR BOX



0.05-30 m  
 +/- 2 mm



20 MEMORY PAMIEC

7 MODES TRYBÓW

GB Laser distance meter  
 D Laserentfernungsmesser  
 PL Dalmierz laserowy  
 RUS Лазерный дальномер  
 CZ Laserový měřič vzdálenosti  
 H Lézeres távolságmérő  
 RO Telemetru cu laser  
 F Télémètre laser  
 I Telemetro laser  
 E Medidores áser de dis ancias  
 CN 激光测距仪

COLOR BOX



0.05-40 m  
 +/- 2 mm



20 MEMORY PAMIEC

8 MODES TRYBÓW

GB Stud finder  
 D Entfernungsmesser  
 PL Wykrywacz profili i przewodów  
 RUS Цифровой детектор  
 CZ Digitální detektor  
 H Digitális kereső műszer  
 RO Detector digital  
 F Détecteur de métaux et de câbles électriques  
 I Detector digitale  
 E scáner de ared  
 CN 墙体探测仪

HANGING COLOR BOX



max.100 mm

CALIBRATION AUTO KALIBRACJA

ZOOM



14

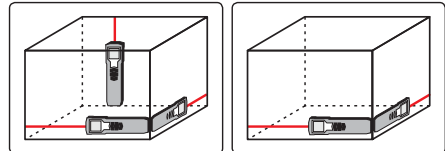
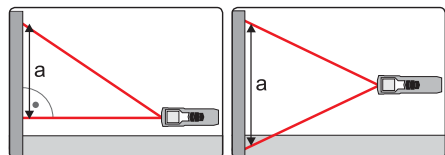

compact size  
 kompaktowy rozmiar

YATO  
 YT-73124



40

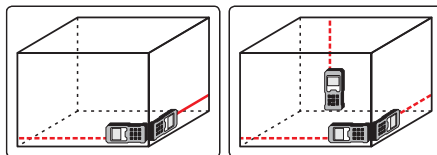
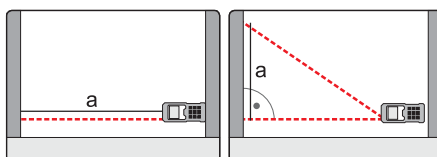

Tripod not included  
 Statyw nie jest częścią zestawu

YATO  
 YT-73125



20

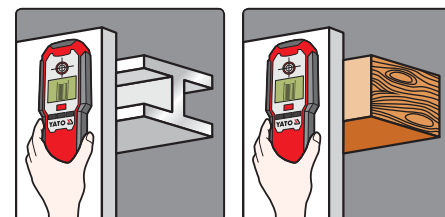
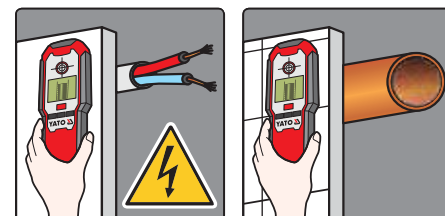

YATO  
 YT-73130



20



GB Aluminium level CZ odováha I ivera  
D Wasserwaage H Vizmérték E Nive  
PL Poziomnica aluminiowa RO Cumpănă CN 铝合金水平尺  
RUS Уровень F Niveau à bulle



SHOCK PROOF  
ODPORNA  
NA WSTRZASY

1.5mm  
ALUMINIUM  
HIGH QUALITY PROFILE  
ALUMINOWY  
PROFIL WYSOKIEJ JAKOŚCI

ACCURACY  
DOKŁADNOŚĆ  
0.057°  
= 1.0 mm/m

3  
PRECISION  
VIALS  
LIBELKI



YATO	L (mm)	
YT-3001	400	20/60
YT-3002	600	20/60
YT-3003	800	20/60
YT-3004	1000	20/60
YT-3005	1200	20/60



YATO	L (mm)	
YT-3022	600	20/60
YT-3023	800	20/60
YT-3024	1000	30
YT-3025	1200	30
YT-3026	1500	30

GB Feeler RO erez  
D Fühlerlehre F Palpeur  
PL Szczelinomierz I Spessimetro  
RUS Щупы E Calibre de fisuras  
CZ Spároměr CN 塞尺  
H Hézagmérő

DOUBLE  
BLISTER



100 mm 10 mm 17 GAUGES LISTKÓW TAPER ZBIEŻNY

YATO	L (mm)	width / szerokość	size / rozmiar	
YT-7220	100	10	0.02, 0.03, 0.04, 0.05, 0.06, 0.07, 0.08, 0.09, 0.10, 0.15, 0.20, 0.25, 0.30, 0.40, 0.50, 0.75, 1.00	10/200

200 mm 12.8 mm 17 GAUGES LISTKÓW PARALLEL RÓWNOLEGŁY

YATO	L (mm)	width / szerokość	size / rozmiar	
YT-7221	200	12.8	0.02, 0.03, 0.04, 0.05, 0.06, 0.07, 0.08, 0.09, 0.10, 0.15, 0.20, 0.25, 0.30, 0.40, 0.50, 0.75, 1.00	10/100



100 mm 10 mm 10 GAUGES LISTKÓW TAPER ZBIEŻNY

YATO	L (mm)	width / szerokość	size / rozmiar	
YT-7222	100	10	0.05, 0.06, 0.07, 0.08, 0.09, 0.10, 0.20, 0.30, 0.40, 0.50	10/100

200 mm 12.8 mm 14 GAUGES LISTKÓW PARALLEL RÓWNOLEGŁY

YATO	L (mm)	width / szerokość	size / rozmiar	
YT-7223	200	12.8	0.05, 0.06, 0.07, 0.08, 0.09, 0.10, 0.15, 0.20, 0.25, 0.30, 0.35, 0.40, 0.45, 0.50	10/100

# 15

## Pneumatic tools Narzędzia pneumatyczne



**Impact wrenches**  
Klucze udarowe

276-278



**Pneumatic accessories**

Akcesoria instalacji pneumatycznej

284-285



**Impact wrenches 3/8"**

Klucze udarowe 3/8"

276

**Air filters, regulators & lubricators**

Filtry, reduktory i smarownice

284

**Impact wrenches 1/2"**

Klucze udarowe 1/2"

276

**Couplers**

Złącza

285

**Impact wrenches 3/4"**

Klucze udarowe 3/4"

277

**Air grease guns**

Smarownice pneumatyczne

286



**Impact wrenches 1"**

Klucze udarowe 1"

278

**Other air tools**

Inne narzędzia pneumatyczne

279-282



**Pneumatic riveters**

Nitownice pneumatyczne

286



**Pneumatic ratchets & sets**

Grzechotki pneumatyczne i zestawy

279

**Pneumatic stitching & nailing machines**

Zszywacze i gwoździarki pneumatyczne

287



**Pneumatic grinders & accessories**

Szlifierki pneumatyczne i akcesoria

279

**Pneumatic cut-off tools & discs**

Przecinarki pneumatyczne i tarcze

281

**Pneumatic drills**

Wiertarki pneumatyczne

281

**Pneumatic hammers**

Młotki pneumatyczne

281

**Tire inflating guns & heads**

Pistolety do pompowania kół i głowice

282

**Pneumatic staplers**

Zszywacze pneumatyczne

287

**Pneumatic nailers**

Gwoździarki pneumatyczne

287

**Painting equipment**

Narzędzia do malowania

282-283



**Mini palm nailers**

Młotki pneumatyczne do gwoździ

287



**Spray guns**

Pistolety lakiernicze

282

**Inflating guns**

Pistolety do przedmuchiwania

283

**Washing guns**

Pistolety do ropowania

283

**Air sand blasters**

Pistolety do piaskowania

283

GB Impact wrench  
D Druckluft-Schlagschrauber  
PL Klucz pneumatyczny  
RUS Ударный пневматический гайковерт  
CZ Klíč pneumatický  
H Pneumatikus ütvecsavarozó

RO Pistol pneumatic  
F Clé à choc pneumatique  
I Chiave ad impulsi pneumatica  
E Llave neumática de percusión  
CN 气动扳手

**3/8"**  
**10mm**

**TWIN HAMMER TYPE**

COMPOSITE BODY  
KOMPOZYTNÁ OBLUČKA

**0.63 MPa**  
**142 l/min**

**400 Nm**

**10000 min<sup>-1</sup>**

**1/4"**  
**6.3mm**



**TWIN HAMMER™**  
*mechanism ensuring resilience to damage and overload*

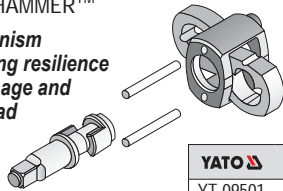

COLOR BOX



YATO	Nm	Box
YT-09501	400	10

GB Impact wrench  
D Druckluft-Schlagschrauber  
PL Klucz pneumatyczny  
RUS Ударный пневматический гайковерт  
CZ Klíč pneumatický  
H Pneumatikus ütvecsavarozó

RO Pistol pneumatic  
F Clé à choc pneumatique  
I Chiave ad impulsi pneumatica  
E Llave neumática de percusión  
CN 气动扳手

**1/2"**  
**12.5mm**

**TWIN HAMMER TYPE**

**0.62 MPa**  
**105 l/min**

**540 Nm**

**7000 min<sup>-1</sup>**

**1/4"**  
**6.3mm**



**TWIN HAMMER™**  
*mechanism ensuring resilience to damage and overload*

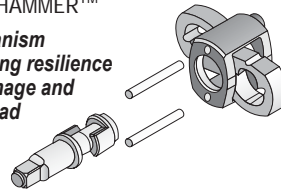

COLOR BOX



YATO	Nm	Box
YT-0952	540	8

GB Impact wrench  
D Druckluft-Schlagschrauber  
PL Klucz pneumatyczny  
RUS Ударный пневматический гайковерт  
CZ Klíč pneumatický  
H Pneumatikus ütvecsavarozó

RO Pistol pneumatic  
F Clé à choc pneumatique  
I Chiave ad impulsi pneumatica  
E Llave neumática de percusión  
CN 气动扳手

**1/2"**  
**12.5mm**

**TWIN HAMMER TYPE**

**0.63 MPa**  
**119 l/min**

**550 Nm**

**7500 min<sup>-1</sup>**

**1/4"**  
**6.3mm**



**TWIN HAMMER™**  
*mechanism ensuring resilience to damage and overload*

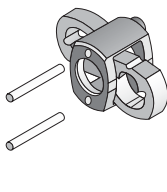

COLOR BOX



YATO	Nm	Box
YT-09511	550	8

GB Impact wrench  
D Druckluft-Schlagschrauber  
PL Klucz pneumatyczny  
RUS Ударный пневматический гайковерт  
CZ Klíč pneumatický  
H Pneumatikus ütvecsavarozó

RO Pistol pneumatic  
F Clé à choc pneumatique  
I Chiave ad impulsi pneumatica  
E Llave neumática de percusión  
CN 气动扳手

**1/2"**  
**12.5mm**

**TWIN HAMMER TYPE**

COMPOSITE BODY  
KOMPOZYTNÁ OBLUČKA

**0.63 MPa**  
**142 l/min**

**570 Nm**

**10000 min<sup>-1</sup>**

**1/4"**  
**6.3mm**



**TWIN HAMMER™**  
*mechanism ensuring resilience to damage and overload*

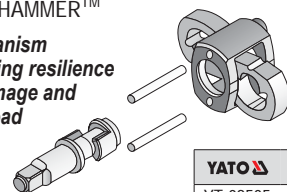

COLOR BOX



YATO	Nm	Box
YT-09505	570	10

GB Impact wrench  
D Druckluft-Schlagschrauber  
PL Klucz pneumatyczny  
RUS Ударный пневматический гайковерт  
CZ Klíč pneumatický  
H Pneumatikus ütvecsavarozó

RO Pistol pneumatic  
F Clé à choc pneumatique  
I Chiave ad impuls pneumatica  
E Llave neumática de percusión  
CN 气动扳手

**1/2"**  
**12.5mm**

**TWIN HAMMER TYPE**

 COMPOSITE BODY  
KOMPÓZITÓVA CSŐFŐLVÁ

**0.63 MPa** **480 l/min**

**1356 Nm** **10000 min<sup>-1</sup>**

**1/4"**  
**6.3mm**



**TWIN HAMMER™**  
*mechanism ensuring resilience to damage and overload*

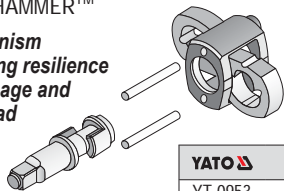

COLOR BOX



YATO	Nm	Box
YT-0953	1356	10

GB Impact wrench  
D Druckluft-Schlagschrauber  
PL Klucz pneumatyczny  
RUS Ударный пневматический гайковерт  
CZ Klíč pneumatický  
H Pneumatikus ütvecsavarozó

RO Pistol pneumatic  
F Clé à choc pneumatique  
I Chiave ad impuls pneumatica  
E Llave neumática de percusión  
CN 气动扳手

**1/2"**  
**12.5mm**

**TWIN HAMMER TYPE**

 COMPOSITE BODY  
KOMPÓZITÓVA CSŐFŐLVÁ

**0.63 MPa** **153 l/min**

**1150 Nm** **10000 min<sup>-1</sup>**

**1/4"**  
**6.3mm**



**TWIN HAMMER™**  
*mechanism ensuring resilience to damage and overload*

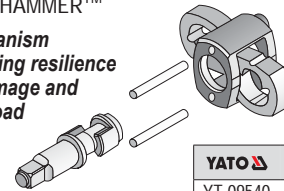

COLOR BOX



YATO	Nm	Box
YT-0954	1150	10

GB Impact wrench  
D Druckluft-Schlagschrauber  
PL Klucz pneumatyczny  
RUS Ударный пневматический гайковерт  
CZ Klíč pneumatický  
H Pneumatikus ütvecsavarozó

RO Pistol pneumatic  
F Clé à choc pneumatique  
I Chiave ad impuls pneumatica  
E Llave neumática de percusión  
CN 气动扳手

**3/4"**  
**19mm**

**DYNA PACT TYPE**

**0.62 MPa** **450 l/min**

**945 Nm** **4500 min<sup>-1</sup>**

**1/4"**  
**6.3mm**



**DYNA-PACT™**  
*mechanism ensuring resilience to damage and overload*



COLOR BOX



YATO	Nm	Box
YT-0956	945	4

GB Impact wrench  
D Druckluft-Schlagschrauber  
PL Klucz pneumatyczny  
RUS Ударный пневматический гайковерт  
CZ Klíč pneumatický  
H Pneumatikus ütvecsavarozó

RO Pistol pneumatic  
F Clé à choc pneumatique  
I Chiave ad impuls pneumatica  
E Llave neumática de percusión  
CN 气动扳手

**3/4"**  
**19mm**

**TWIN HAMMER TYPE**

 COMPOSITE BODY  
KOMPÓZITÓVA CSŐFŐLVÁ

**0.63 MPa** **198 l/min**

**1630 Nm** **5500 min<sup>-1</sup>**

**3/8"**  
**10mm**



**TWIN HAMMER™**  
*mechanism ensuring resilience to damage and overload*

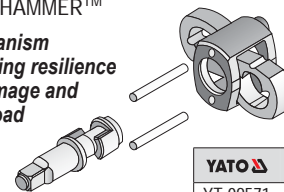

COLOR BOX



YATO	Nm	Box
YT-09571	1630	6

GB Pneumatic wrench  
D Druckluft-Schlüssel  
PL Klucz pneumatyczny  
RUS Пневматический ключ  
CZ Pneumatický utahovák  
H Pneumatikus kulcs

RO Cheie pneumatica  
F Clé à choc pneumatique  
I Chiave ad impulsi pneumatica  
E Llave neumatica  
CN 气动扳手

**PINLESS HAMMER™**

**closed hammer cage mechanism prevents breakage from hammer pin damage**

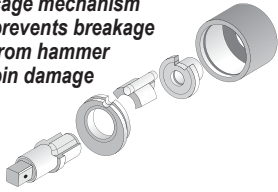

- application: automotive service stations, trucks
- strong, uniform impact
- przeznaczenie: serwis, samochody ciężarowe
- siln , jednolity uder



1" 25mm	PINLESS HAMMER TYPE	0.63 MPa	560 l/min
2600 Nm	4000 min <sup>-1</sup>	1/2" 12.5mm	

BMC & COLOR SLEEVE



<b>YATO</b>	Nm	
YT-0959	2600	2

GB Pneumatic wrench  
D Druckluft-Schlüssel  
PL Klucz pneumatyczny  
RUS Пневматический ключ  
CZ Pneumatický utahovák  
H Pneumatikus kulcs

RO Cheie pneumatica  
F Clé à choc pneumatique  
I Chiave ad impulsi pneumatica  
E Llave neumatica  
CN 气动扳手

**PINLESS HAMMER™**

**closed hammer cage mechanism prevents breakage from hammer pin damage**

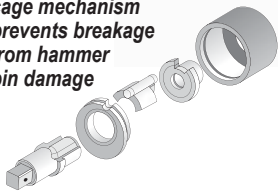

- application: automotive service stations, trucks
- strong, uniform impact
- przeznaczenie: serwis, samochody ciężarowe
- siln , jednolity uder



1" 25mm	PINLESS HAMMER TYPE	0.63 MPa	560 l/min
2600 Nm	4000 min <sup>-1</sup>	1/2" 12.5mm	

BMC & COLOR SLEEVE



<b>YATO</b>	Nm	
YT-0960	2600	2

GB Pneumatic wrench  
D Druckluft-Schlüssel  
PL Klucz pneumatyczny  
RUS Пневматический ключ  
CZ Pneumatický utahovák  
H Pneumatikus kulcs

RO Cheie pneumatica  
F Clé à choc pneumatique  
I Chiave ad impulsi pneumatica  
E Llave neumatica  
CN 气动扳手

- application: industrial service stations, tire service stations, truck service
- the lightest 1" impact wrench with torque of 2700 Nm
- magnesium alloy and composite housing
- low vibration
- low air consumption
- przeznaczenie: przemysł, serwisy mobilne i stacjonarne, serwisy opon oraz pojazdów ciężarowych
- najlżejszy klucz pneumatyczny w klasie 1" o mocy 2700 Nm
- obudowa ze stopów magnezu i kompozytu
- niski poziom wibracji
- małe zużycie powietrza



Durable twin hammer mechanism.

Mechanizm uderowy typu TWIN HAMMER.

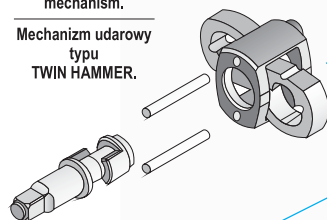

Humanized special changeable supports handle for left-handers purpose.  
Rękojeść pomocnicza (prawa lub lewa strona).

Unique composite motor housing.  
Obudowa kompozytowa.

High strength aluminum alloy.  
Wysokowytrzymały stop aluminium.

Setting with 3 forward and 3 reverse speed.  
Trójstopniowy regulator mocy.

Trigger with 2 speed control.  
Włącznik z dwustopniową regulacją prędkości.

Two way changeable air inlet direction for comfort workplace.  
Alternatywne gniazda przyłączeniowe.



1" 25mm	TWIN HAMMER TYPE	0.63 MPa	255 l/min
8.3kg ULTRA LIGHT	2700 Nm	4800 min <sup>-1</sup>	
1/4" 6.3mm	1/2" 12.5mm		



COLOR BOX



<b>YATO</b>	Nm	
YT-09611	2700	2

GB Ra che air wrench  
D Druckluft-Ratschenschrauber  
PL Grzechotka pneumatyczna  
RUS Пневмотрещотка  
CZ Uťahovák vzduchový  
H Préslevegős behajtó szerszám  
RO Antrenor pneumatic  
F Clé à cliquet pneumatique  
I Chiave a cricchetto pneumatica  
E Carraca neumática  
CN 气动棘轮扳手



COLOR BOX



1/2" 12.5mm	0.62 MPa	120 l/min
80 Nm	160 min <sup>-1</sup>	1/4" 6.3mm

<b>YATO</b>	Nm	
YT-0981	80	20

GB Ra che air wrench  
D Druckluft-Ratschenschrauber  
PL Grzechotka pneumatyczna  
RUS Пневмотрещотка  
CZ Uťahovák vzduchový  
H Préslevegős behajtó szerszám  
RO Antrenor pneumatic  
F Clé à cliquet pneumatique  
I Chiave a cricchetto pneumatica  
E Carraca neumática  
CN 气动棘轮扳手



COLOR BOX



1/2" 12.5mm	0.62 MPa	110 l/min
68 Nm	160 min <sup>-1</sup>	1/4" 6.3mm

<b>YATO</b>	Nm	
YT-0980	68	20

GB Ra che wrench ki  
D Druckluft-Ratschenschrauber mit Zubehör  
PL Zestaw z grzechotką pneumatyczną  
RUS Пневмотрещотка в наборе  
CZ Klíč ráčnový pneumatický s příslušenstvím  
H Pneumatikus racsniskulcs készlet  
RO Cheie pneumatica cu accesorii  
F Clé à cliquet pneumatique  
I Chiave a cricchetto pneumatica  
E Juego con carraca neumática  
CN 气动棘轮扳手组套



- 1/2" (12.7 mm), L=75 mm;
- 6 mm x 1/2" (12.7 mm);
- 1/2" (12.7 mm);
- H4, H5, H6, H7, H8;
- T20, T25, T27, T30, T40;
- 5.5, 6.5, 8.0 mm;
- PH2, PH3, PH4;
- 10, 11, 12, 13, 14, 17, 19 mm

1/2" 12.5mm	OILER POT
0.62 MPa	110 l/min
68 Nm	160 min <sup>-1</sup>
1/4" 6.3mm	CrV

<b>YATO</b>	Nm	
YT-0982	68	4

BMC  
& COLOR  
SLEEVE



GB Air grinder  
D Drucklufterhandschleifer  
PL Szlifierka pneumatyczna prosta  
RUS Шлифмашинка пневматическая  
CZ Bruska přímá pneumatická  
H Préslevegős sarokcsiszoló  
RO Polizor pneumatic  
F Mini ponceuse pneumatique  
I Smerigliatrice dritta pneumatica  
E Lijadora neumática recta  
CN 气动修磨机



COLOR BOX



0.62 MPa	160 l/min
20000 min <sup>-1</sup>	3 6mm
	1/4" 6.3mm

<b>YATO</b>	
YT-0965	25

GB Air sander  
D Druckluft-Excenterschleifer  
PL Szlifierka pneumatyczna mimośrodowa  
RUS Шлифмашинка эксцентриковая пневматическая  
CZ Bruska pneumatická  
H Pneumatikus sarokcsiszológép  
RO Masina de slefuit pneumatica  
F Ponceuse pneumatique  
I Smerigliatrice orbitale pneumatica  
E Lijadora neumática excéntrica  
CN 气动砂磨机



0.62 MPa	230 l/min
9000 min <sup>-1</sup>	mm
	150
	ECCENTRIC
	1/4" 6.3mm

<b>YATO</b>	
YT-0967	10

COLOR  
BOX



GB ir sander  
 D Druckluft-Excenterschleifer  
 PL Szlifierka pneumatyczna oscylacyjna  
 RUS Шлифмашина эксцентриковая пневматическая  
 CZ Bruska pneumatická  
 H Pneumatikus sarokcsiszológép  
 RO Masina de slefuit pneumatica  
 F Ponceuse triangulaire  
 I Levigatrice pneumatica  
 E Lijadora neumática  
 CN 气动三角形砂磨机

0.62 MPa  
 71 l/min  
 10000 min<sup>-1</sup>  
 VACUUM SYSTEM  
 SYSTEM ODPYLANIA  
 143x99 mm  
 1/4"  
 6.3mm



COLOR BOX

<b>YATO</b>	
YT-0976	10

GB ir sander  
 D Druckluft-Excenterschleifer  
 PL Szlifierka pneumatyczna oscylacyjna  
 RUS Шлифмашина эксцентриковая пневматическая  
 CZ Bruska pneumatická  
 H Pneumatikus sarokcsiszológép  
 RO Masina de slefuit pneumatica  
 F Ponceuse rectangulaire  
 I Levigatrice pneumatica  
 E Lijadora neumática  
 CN 气动三角形砂磨机

0.62 MPa  
 71 l/min  
 10000 min<sup>-1</sup>  
 VACUUM SYSTEM  
 SYSTEM ODPYLANIA  
 130x80 mm  
 1/4"  
 6.3mm



COLOR BOX

<b>YATO</b>	
YT-0977	10

GB ir be sander  
 D Pneumatische Bandschleifer  
 PL Pneumatyczna szlifierka taśmowa  
 RUS Пневматический шлифовальный  
 CZ Pneumatická pásová bruska  
 H Pneumatikus szalagcsiszoló  
 RO Polizor pneumatic cu banda  
 F Ponceuse à bandes pneumatique  
 I Nastro per levigatrice pneumatica  
 E Lijadora de banda neumática  
 CN 气动砂带机



0.63 MPa  
 20000 min<sup>-1</sup>  
 EASY BELT REPLACEMENT  
 LATWA WYMIANA PASA  
 1/4"  
 6.3mm



COLOR BOX

<b>YATO</b>	belt size / rozmiar pasa (mm)	
YT-09741	10 330	10

includes belts: / w zestawie pasy:

60 80 120

GB ir be sander  
 D Pneumatische Bandschleifer  
 PL Pneumatyczna szlifierka taśmowa  
 RUS Пневматический шлифовальный  
 CZ Pneumatická pásová bruska  
 H Pneumatikus szalagcsiszoló  
 RO Polizor pneumatic cu banda  
 F Ponceuse à bandes pneumatique  
 I Nastro per levigatrice pneumatica  
 E Lijadora de banda neumática  
 CN 气动砂带机



0.63 MPa  
 20000 min<sup>-1</sup>  
 EASY BELT REPLACEMENT  
 LATWA WYMIANA PASA  
 1/4"  
 6.3mm



COLOR BOX

<b>YATO</b>	belt size / rozmiar pasa (mm)	
YT-09742	20 520	10

includes belts: / w zestawie pasy:

60 80 120

GB Endless sanding belt  
 D Sch eifband  
 PL Taśma ścierna bezkońcowa  
 RUS Шлифовальные ленты

CZ Brusný pás  
 H Csiszoló szalag  
 RO Bandă de pânză

F Bande abrasive sans fin  
 I Nastro abrasivo senza fine

E Pano abrasivo cinturón  
 CN 砂带

TIED ON CARD



- application: metal, wood
- abrasive: aluminium oxide
- bond: synthetic resin
- coating: close

- zastosowanie: metal, drewno
- ścierniwo: tlenek glinu
- spoiwo: żywica syntetyczna
- nasyp pełny

- application: metal, wood
- abrasive: aluminium oxide
- bond: synthetic resin
- coating: close

- zastosowanie: metal, drewno
- ścierniwo: tlenek glinu
- spoiwo: żywica syntetyczna
- nasyp pełny

YATO	grit / ziarnistość	size / rozmiar (mm)	PCS packing	
YT-09743	60	10 330	10	100
YT-09744	80	10 330	10	100
YT-09745	100	10 330	10	100
YT-09746	120	10 330	10	100

YATO	grit / ziarnistość	size / rozmiar (mm)	PCS packing	
YT-09747	60	20 520	10	50
YT-09748	80	20 520	10	50
YT-09749	100	20 520	10	50
YT-09750	120	20 520	10	50



GB Air cut-off tool  
D Druckluft-Schneidmaschine  
PL Przecinarka pneumatyczna  
RUS Резак пневматический  
CZ Příčná bruska pneumatická  
H Pneumatikus sarokcsiszoló

RO Masina de aia cu aer comprimat  
F Coupeuse pneumatique  
I Fresa pneumatica  
E Cortadora neumática  
CN 气动切割工具

**0.62 MPa**  
**160 l/min**  
**18000 min<sup>-1</sup>**  
1/4"  
6.3mm



COLOR BOX

**YATO**  
YT-0993 20

GB Metal cutting disc  
D Me a -Trennscheibe  
PL Tarcza do cięcia metalu  
RUS Круги отрезные по металлу  
CZ Souprava kotoučů pro řezání kovu  
H Vágókorong fémhez  
RO Set de pânze de tăiat metal  
F Set de disques  
I Disco per taglio metallo  
E Disco cor ador para metal  
CN 金属切割片组套

for / dla: YT-0993

**5 PCS**  
**75mm**  
**2mm**  
**9.5mm**  
**18000 min<sup>-1</sup>**



BLISTER CARD

**YATO**  
YT-0994 12/48

GB Reversib e air dri  
D Druckluft-Bohrmaschine mit Stahl-Zahnkranzfutter  
PL Wiertarka pneumatyczna  
RUS Пневматическая дрель  
CZ Vrtáčka ruční vzduchová  
H Préslevegős fúrógép  
RO Masina de gaurit pneumatica mandrina  
F Perceuse pneumatique  
I Fresa pneumatica  
E Taladradora neumática  
CN 双向气钻



**0.62 MPa**  
**180 l/min**  
**0-1800 min<sup>-1</sup>**  
max. 10mm  
1/4"  
6.3mm

COLOR BOX

**YATO**  
YT-0970 20

GB Reversib e air dri  
D Druckluft-Bohrmaschine mit Stahl-Zahnkranzfutter  
PL Wiertarka pneumatyczna  
RUS Пневматическая дрель  
CZ Vrtáčka ruční vzduchová  
H Préslevegős fúrógép

RO Masina de gaurit pneumatica mandrina  
F Perceuse pneumatique  
I Fresa pneumatica  
E Taladradora neumática  
CN 双向气钻



**1.7 kg**  
**0.63 MPa**  
**198 l/min**  
**700 min<sup>-1</sup>**  
max. 10mm  
1/4"  
6.3mm

COLOR BOX

**YATO**  
YT-09702 12



GB Air hammer  
D Druckluft-Schlaghammer  
PL Młotek pneumatyczny  
RUS Зубило пневматическое  
CZ Sekáč vzduchový  
H Pneumatikus vésőkészlet  
RO Ciosam cu aer comprimat  
F Maretau pneumatique  
I Martello pneumatica  
E Martillo neumático  
CN 气锤



**0.62 MPa**  
**110 l/min**  
**3200 min<sup>-1</sup>**  
1/4"  
6.3mm

COLOR BOX

**YATO**  
YT-0990 10

- GB Tire-inflating gun
- D Reifenfüller
- PL Pistolet do pompowania kół
- RUS Пистолет для накачивания колёс
- CZ Pistole na čerpání z manometrem
- H Gumiabroncs pumpáló
- RO Pistol cu manometru pt. pompat
- F Pistolet pour gonflage de pneus avec manomètre
- I Pistola per gonfiaggio gomme
- E Pistola de bombeo con manometro
- CN 轮胎气压表



1/4"	0.8 MPa (max.)
6.3mm	
440mm HOSE WAZ	AI



SLIDING CARD

<b>YATO</b>	
YT-2370	8/40

- GB Inflating head
- D Klemmnippel (universal)
- PL Glowica do pompowania
- RUS Универсальная головка
- CZ Hlava na čerpání
- H Pumpafej
- RO Cap pt. pompat
- F Mandrin de pompe
- I Testa per il pompaggio
- E Cabeza de bombeo
- CN 充气头



DOUBLE BLISTER



1.0 MPa (max.)
----------------

<b>YATO</b>	Ø (mm)	
YT-2371	6	50/300
YT-2372	8	50/300

- GB Spray gun with fluid cup
- D Lackierpistole mit Fließbecher
- PL Pistolet z kielichem
- RUS Пистолет - распылитель с верхним бачком

- CZ Pistole na lakování z nádrží
- H Festőpisztoly alsó tartállyal
- RO Pistol de vopsit cu rezervor inferior
- F Pistolet à peinture
- I Pistola vernice

- E Pistola de barniz
- CN 喷枪

COLOR BOX



15



Ø 1.4 mm
----------

410 l/min	0.6l
0.30 MPa	HVLP

<b>YATO</b>	
YT-2340	20

Ø 1.5 mm
----------

410 l/min	0.6l
0.30 MPa	HVLP

<b>YATO</b>	
YT-2341	20

Ø 1.8 mm
----------

380 l/min	0.40 MPa	1.0l
-----------	----------	------

<b>YATO</b>	
YT-2346	10

Ø 0.8 mm
----------

220 l/min	0.1l
0.30 MPa	HVLP

<b>YATO</b>	
YT-2357	20

- GB Inflating gun with extension  
D Gebläsepistole mit Verlängerung  
PL Pistolet do przedmuchiwania z przedłużką  
RUS Пистолет для продувки с удлинителем  
CZ Pistolet na profukování dlouhá  
H Rövid előlefeűvó pisztoly  
RO Pistol lung pt. suflat  
F Pistolet pour purger  
I Pistolet professionale  
E Pistola de sonda  
CN 长杆充气枪



1/4"  
6.3mm

0.8  
MPa  
(max.)

AI



SLIDING CARD

**YATO**

YT-2373

20/40

- GB Washing gun  
D Waschpistole  
PL Pistolet do mycia  
RUS Пистолет для нефтывания  
CZ Pistolet na ropování + nádrž  
H Olajozító arányos  
RO Pistol (dozator) cu rezervor pt. motorină  
F Pistolet à l'huile  
I Pistola di lavaggio con nafta  
E Pistola de detergente  
CN 喷水枪



0.85l

130  
l/min

AI

0.80  
MPa



COLOR BOX

**YATO**

YT-2374

2/12

- GB Air sand blaster  
D Pistole zum Sandstrahlen  
PL Pistolet do piaskowania z węzłem  
RUS Пескоструйный пистолет  
CZ Pískovací lisovací hadic  
H Homokszóró pisztoly tömlővel  
RO Pistol de sabla  
F Pistolet de sablage avec tuyau  
I Pistola a sabbia rice  
E Pistola para limpieza con chorro de arena con manguera  
CN 吹气枪

1/4"  
6.3mm

∅ 6.3 mm

160  
l/min

1m  
HOSE  
WAZ

AI

0.80  
MPa



SLIDING CARD

**YATO**

YT-2375

10

- GB Gun suitable for sand-blasting  
D Sandstrahlpistole  
PL Pistolet do piaskowania ze zbiornikiem  
RUS Пескоструйный пистолет  
CZ Pískovací pistole se zásobníkem  
H Homokszóró pisztoly tartállyal  
RO Pistol de sabla  
F Pistolet de sablage avec réservoir  
I Pistola a sabbia rice con serba olio  
E Pistola para limpieza con chorro de arena con reci  
CN 喷枪

1.0l

160  
l/min

AI

0.80  
MPa



COLOR BOX

**YATO**

YT-2376

20

GB Mini filter  
D Fi r  
PL Fi r  
RUS Минифильтр  
CZ Fi r  
H Szűrő  
RO Minifiltru  
F Vidange mini  
I Fi ro  
E Fi ro  
CN 微型过滤器

**1.4**  
MPa  
(max.)

**8**  
cm<sup>3</sup>

**1/4"**  
**6.3mm**



COLOR BOX

**YATO**  
YT-2380 25/50

GB Pressure reducing valve with manometer  
D Druckminderer mit Manometer  
PL Reduktor ciśnienia z manometrem  
RUS Клапан уменьшения давления с манометром  
CZ Redukční ventil s manometrem  
H Nyomáscsökkentő szelep nyomásmérővel  
RO Valva cu reductiepresiune + manometru  
F Réducteur avec manomètre  
I Regolatore di pressione con manometro  
E Reductor + manometro  
CN 带表调压减压阀

**1.2**  
MPa  
(max.)

**1/4"**  
**6.3mm**



COLOR BOX

**YATO**  
YT-2381 25/50

GB Filter - reducer  
D Druckfilter - Druckminderer  
PL Filtr - reduktor  
RUS Фильтр - редуктор  
CZ Filtr derukční ventil  
H Szűrő - nyomásszabályzó  
RO Filtru cu reductor  
F Réducteur avec filtre et manomètre  
I Filtro regolatore  
E Reductor + filtro  
CN 过滤器

**0.93**  
MPa  
(max.)

**15**  
cm<sup>3</sup>

**60°C**  
max.

**1/4"**  
**6.3mm**



COLOR BOX

**YATO**  
YT-2382 25/50

GB Filter - reducer  
D Druckfilter - Druckminderer  
PL Filtr - reduktor  
RUS Фильтр - редуктор  
CZ Filtr derukční ventil  
H Szűrő - nyomásszabályzó  
RO Filtru cu reductor  
F Réducteur avec filtre et manomètre  
I Filtro regolatore  
E Reductor + filtro  
CN 过滤器

**0.93**  
MPa  
(max.)

**90**  
cm<sup>3</sup>

**60°C**  
max.

**1/2"**  
**12.5mm**



COLOR BOX

**YATO**  
YT-2383 25/50

GB Air filter regulator and lubricator  
D Druckfilter - Druckminderer + Entöler  
PL Zespól filtrujący reduktor + smarownica  
RUS Фильтр-редуктор  
CZ Redukční ventil s odlučovačem oleje  
H Levegőelőkészítő  
RO Filtru cu reductor  
F Filtre régulateur lubrificateur pour air comprimé  
I Filtro regolatore lubrificatore  
E Juego de filtro reductor + engrasador  
CN 气动三联件

**0.93**  
MPa  
(max.)

**25 cm<sup>3</sup>**  
FILTER

**15 cm<sup>3</sup>**  
LUBRICANT CUP  
SMAROWNICA

**60°C**  
max.

**1/4"**  
**6.3mm**



COLOR BOX

**YATO**  
YT-2384 25/50

GB Air filter regulator and lubricator  
D Druckfilter - Druckminderer + Entöler  
PL Zespól filtrujący reduktor + smarownica  
RUS Фильтр-редуктор  
CZ Redukční ventil s odlučovačem oleje  
H Levegőelőkészítő  
RO Filtru cu reductor  
F Filtre régulateur lubrificateur pour air comprimé  
I Filtro regolatore lubrificatore  
E Juego de filtro reductor + engrasador  
CN 气动三联件

**0.93**  
MPa  
(max.)

**90 cm<sup>3</sup>**  
FILTER

**60 cm<sup>3</sup>**  
LUBRICANT CUP  
SMAROWNICA

**60°C**  
max.

**1/4"**  
**6.3mm**



COLOR BOX

**YATO**  
YT-2385 25

GB Quick coupler  
D Schnellkupplung  
PL Szybkozłącze  
RUS Быстрое соединение

CZ Rychlosoka  
H Gyorscsatlakozó  
RO Mufa rapidă pt. pistol pneumatic  
F Raccord rapide

I accorrido  
E Cone ión de a en rada de aire  
CN 快速接头

SLIDING  
CARD

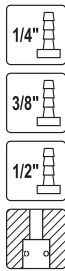
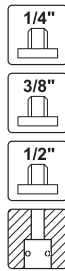

YATO	size / rozmiar	
YT-2390	1/4" (6.3 mm)	50/250
YT-2391	3/8" (10.0 mm)	50/250
YT-2392	1/2" (12.5 mm)	50/250

YATO	size / rozmiar	
YT-2393	1/4" (6.3 mm)	50/250
YT-2394	3/8" (10.0 mm)	50/250
YT-2395	1/2" (12.5 mm)	50/250

YATO	size / rozmiar	
YT-2396	1/4" (6.3 mm)	50/250
YT-2397	3/8" (10.0 mm)	50/250
YT-2398	1/2" (12.5 mm)	50/250

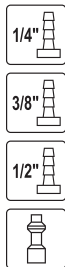
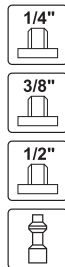

YATO	size / rozmiar	
YT-2399	1/4" (6.3 mm)	50/250
YT-2401	3/8" (10.0 mm)	50/250
YT-2402	1/2" (12.5 mm)	50/250

YATO	size / rozmiar	
YT-2403	1/4" (6.3 mm)	50/250
YT-2404	3/8" (10.0 mm)	50/250

YATO	size / rozmiar	
YT-2405	1/4" (6.3 mm)	50/250
YT-2406	3/8" (10.0 mm)	50/250
YT-2407	1/2" (12.5 mm)	50/250

GB 2 way quick coupler  
D Zwei-wege schnellkupplung  
PL Szybkozłącze podwójne  
RUS Двусторонняя быстроразъемные соединения  
CZ Two-wo rchosa  
H Levegőelosztó kettős gyorscsatlakozó  
RO Distribuitoare cuple rapide  
F Dérivation type y en cuivre  
I Raccordo one con vie  
E Manera 2 manguera de aire pase de acoplamiento rápido  
CN 三通万用插嘴



SLIDING  
CARD

YATO	
YT-24091	25/50

GB Quick coupler  
D Schnellkupplung  
PL Szybkozłącze  
RUS Быстрое соединение  
CZ Rychlosoka  
H Gyorscsatlakozó  
RO Mufa rapidă pt. pistol pneumatic  
F Raccord rapide  
I accorrido  
E Cone ión de a en rada de aire  
CN 快速接头



SLIDING  
CARD

YATO	
YT-24092	50/100

GB Quick coupler  
D Schnellkupplung  
PL Szybkozłącze  
RUS Быстрое соединение  
CZ Rychlosoka  
H Gyorscsatlakozó  
RO Mufa rapidă pt. pistol pneumatic  
F Raccord rapide  
I accorrido  
E Cone ión de a en rada de aire  
CN 快速接头



SLIDING  
CARD

YATO	
YT-24093	50/100

GB Quick coupler  
D Schnellkupplung  
PL Szybkozłącze  
RUS Быстрое соединение  
CZ Rychlosoka  
H Gyorscsatlakozó

RO Mufa rapidă pt. pistol pneumatic  
F Raccord rapide  
I accorrido  
E Cone ión de a en rada de aire  
CN 快速接头



SLIDING  
CARD

YATO	
YT-24094	50/100

GB Quick coupler  
D Schnellkupplung  
PL Szybkozłącze  
RUS Быстрое соединение  
CZ Rychlosoka  
H Gyorscsatlakozó

RO Mufa rapidă pt. pistol pneumatic  
F Raccord rapide  
I accorrido  
E Cone ión de a en rada de aire  
CN 快速接头



SLIDING  
CARD

YATO	
YT-24095	50/100

- |  |                                     |
|--|-------------------------------------|
| GB Air grease gun  | RO Pistol pt. gresat pneumatic      |
| D Druckluft-Fettpresse                                   | F Pistolet de graissage pneumatique |
| PL Smarownica pneumatyczna                               | I Pneumatica per ingrassaggio       |
| RUS Шприц для нагнетания<br>густой смазки пневматический | E Pistola engrasadora neumática     |
| CZ Mazací lis pneumatický                                | CN 气动黄油枪                            |
| H Pneumatikus zsírzó                                     |                                     |

400 cm<sup>3</sup> 28 l/min 1/4" 6.3mm

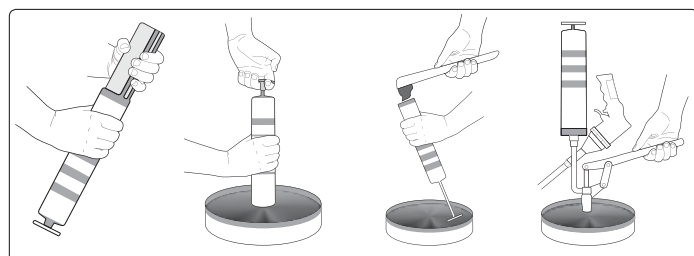

<b>YATO</b>	
YT-07055	10

- |                                |                               |
|--------------------------------|-------------------------------|
| GB Pneumatic riveting machine  | RO Presa pneumatica de nituti |
| D Pneumatische Nietvorrichtung | F Riveuse pneumatique         |
| PL Nitownica pneumatyczna      | I Rivettatrice pneumatica     |
| RUS Пневматический заклепочник | E Máquina remachadora         |
| CZ Pneumatická nýtovačka       | CN 气动拉铆枪                      |
| H Pneumatikus popszegecsző     |                               |



STAINLESS STEEL, STEEL, ALUMINUM, STAL, NIERZEWNA, STAL, ALUMINIUM 1/4" 0.62 MPa 6.3mm

15



- x4** • application: industr  
• przeznaczenie: przemysł

- x5** • application: industr  
• przeznaczenie: przemysł

YATO	Ø (mm)	L (mm)	F (kg)	F (N)	
YT-3617	2.4; 3.2; 4.0; 4.8	14	850	8335	10

YATO	Ø (mm)	L (mm)	F (kg)	F (N)	
YT-3618	2.4; 3.2; 4.0; 4.8; 6.4	16	1389	13620	6

GB Pneumatic stitching machine  
D Drucklufthefter  
PL Zszywacz pneumatyczny  
RUS Пневматический шиватель  
CZ Pneumatická sešivačka  
H Pneumatikus tűzőgép

RO Capsator pneumatic  
F Agrafeuse pneumatique  
I Cucitrice pneumatica  
E Engrapadora pneumatica  
CN 气动码钉枪

**7**  
bar  
**8-25**  
mm  
**1/4"**  
6.3 mm

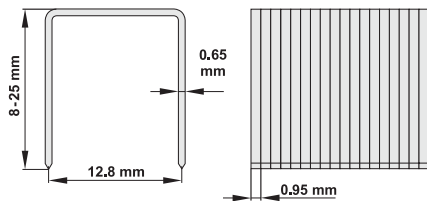

BMC & COLOR SLEEVE

- application: industr , construction
- przeznaczenie: przemysł, budownictwo

**YATO**  
YT-0920 5

GB Pneumatic nailing machine  
D Druckluftnagelgerät  
PL Gwoździarka pneumatyczna  
RUS Пневматическая гвоздильная машина  
CZ Pneumatický nástřelovač hřebíků  
H Pneumatikus szögbelevő  
RO Capsator pneumatic

F Cloueur pneumatique  
I Chiodatrice pneumatica  
E Maquina pneumatica ara c avar c avos  
CN 气动码钉枪

**8**  
bar  
**25-64**  
mm  
**90°**  
**1/4"**  
6.3 mm

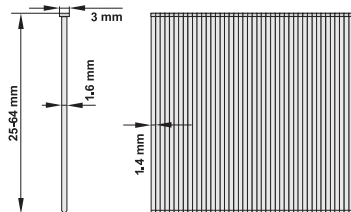

BMC & COLOR SLEEVE

- application: industr , construction
- przeznaczenie: przemysł, budownictwo

**YATO**  
YT-0921 5

GB Pneumatic nailing machine  
D Druckluftnagelgerät  
PL Gwoździarka pneumatyczna  
RUS Пневматическая гвоздильная машина  
CZ Pneumatický nástřelovač hřebíků  
H Pneumatikus szögbelevő  
RO Capsator pneumatic  
F Cloueur pneumatique  
I Chiodatrice pneumatica  
E Maquina pneumatica para clavar clavos  
CN 气动码钉枪

**8**  
bar  
**50-90**  
mm  
**34°**  
**1/4"**  
6.3 mm

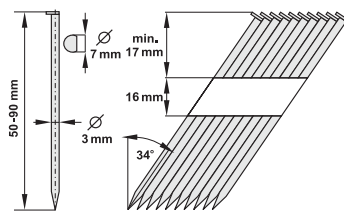

BMC & COLOR SLEEVE

- application: industr , construction
- przeznaczenie: przemysł, budownictwo

**YATO**  
YT-0923 2

GB Mini palm nailer  
D Drucklufthammer für Nägel  
PL Młotek pneumatyczny do gwoździ  
RUS Пневматический молоток для забивания гвоздей  
CZ Pneumatická hřebíkovačka  
H Pneumatikus szögbeütő kalapács  
RO Ciocan pneumatic pt. cuie  
F Cloueur pneumatique  
I Chiodatrice pneumatica  
E Maquina pneumatica ara c avar c avos  
CN 迷你气动钉枪

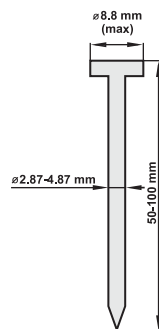

**0.70**  
MPa  
**1/4"**  
6.3 mm

COLOR BOX

**YATO**  
YT-0925 20













# 16

**Special automotive tools  
& equipment**

**Narzędzia i wyposażenie  
warsztatu samochodowego**





<b>Cabinets</b> Szafki		Spark plug sockets Klucze do świec.....	349
.....	291-307	<b>Brake system tools</b> Narzędzia do obsługi układu hamulcowego	
Roller cabinets with tools insert Szafki serwisowe z narzędziami.....	291	.....	350-354
<b>Tool cabinets</b> Szafki serwisowe.....	296	<b>Suspension system tools</b> Narzędzia do obsługi podwozia	
<b>Workbenches</b> Stoły warsztatowe.....	300	.....	355-358
<b>Tools in PVC trays</b> Zestawy narzędzi do szuflad.....	300	<b>Spring clamps &amp; accessories</b> Ściągacze do sprężyn i akcesoria.....	355
<b>Accessories for tool cabinets &amp; workbenches</b> Akcesoria do szafek i stołów.....	306	<b>Shock absorber nut sets</b> Zestawy nasadek do amortyzatorów.....	356
<b>Tool boxes</b> Skrzynki narzędziowe		<b>Tire valve stem inserter</b> Przeciągacze do zaworów gumowych.....	356
.....	308-310	<b>Wheel balance pliers</b> Szczypce do wyważania kół.....	357
<b>Lubrication system tools</b> Narzędzia do obsługi układu smarowania		<b>Deep thin wall impact sockets 1/2"</b> Udarowe klucze nasadowe 1/2" do felg aluminiowych.....	357
.....	311-317	<b>Valve core torque tools</b> Klucze dynamometryczne do zaworów gumowych i metalowych.....	357
<b>Oil filter wrenches &amp; sets</b> Klucze do filtra oleju i zestawy.....	311	<b>Wheel wrenches</b> Klucze do kół.....	358
<b>Oil drain plug sockets</b> Klucze do spustu oleju.....	313	<b>Tire levels</b> Łyżki do opon.....	358
<b>Grease guns &amp; accessories</b> Smarownice ręczne, pneumatyczne i akcesoria.....	314	<b>Workshop tools</b> Narzędzia warsztatowe	
<b>Oil cans</b> Oliwiarki.....	317	.....	358-366
<b>Oil and fuel pumps</b> Pompy do oleju oraz paliwa.....	317	<b>Flexi shafts</b> Wałki giętkie.....	358
<b>Pullers</b> Ściągacze		<b>Inspection tools</b> Narzędzia inspekcyjne.....	359
.....	318-331	<b>Magnetic pick up tools</b> Chwytyki magnetyczne.....	360
<b>Pullers</b> Ściągacze.....	318	<b>Magnetic trays</b> Tacki magnetyczne.....	360
<b>Roller stud extractor sets</b> Zestawy ściągaczy do szpilek.....	323	<b>Tweezers</b> Pęsety.....	361
<b>Upholstery removers</b> Ściągacze do tapicerki.....	331	<b>Workshop creepers</b> Leżanki warsztatowe.....	361
<b>Car window tools</b> Narzędzia do szyb samochodowych		<b>LED workshop lightning</b> Oświetlenie warsztatowe LED.....	362
.....	331-332	<b>Breathalyzers</b> Alkomaty.....	364
<b>Air condition tools</b> Narzędzia do klimatyzacji		<b>Voltage testers</b> Próbniki napięcia.....	365
.....	332	<b>Number &amp; letter stamps</b> Znaczniki cyfrowe i literowe.....	365
<b>Fuel feel pipe pliers</b> Szczypce motoryzacyjne		<b>Thread repair sets &amp; accessories</b> Zestawy do naprawy gwintów i akcesoria.....	365
.....	333-337	<b>Tire pressure gauges</b> Mierniki ciśnienia.....	366
<b>Engine repair tools</b> Narzędzia do obsługi silnika		<b>Pumps</b> Pompki.....	366
.....	338-349	<b>Funnels, oil drainer &amp; drainer pans</b> Lejki, miski i zlewarki do oleju	
<b>Piston ring compressors</b> Zaciskacze do pierścieni.....	338	.....	367
<b>Engine repair and diagnostic tools</b> Narzędzia do diagnostyki i naprawy silników.....	338	<b>Bottle &amp; floor jacks</b> Dźwigniki słupkowe i podnośniki	
.....	338-349	.....	368-369

Work benches  
Stojaki lakiernicze

369



Electric hoists  
Elektryczne wciągarki linowe

373



Refractometers  
Refraktometry

369



Hand pullers  
Wciągarki linowe, ręczne

373



Battery chargers & battery testers  
Prostowniki i testery akumulatorów

370-372



Shop cranes & shop presses  
Żurawie i prasy warsztatowe

374-375



Chain blocks  
Wciągarki łańcuchowe

373



Workshop standardized parts  
Normalia motoryzacyjne

376-377



GB Service oo cabine wi h oos  
D Serviceschrank mi erkzeu en  
PL Szafka serwisowa z narzędziami  
RUS Сервисный шкаф с инструментами  
CZ Servisní skříňka s nářadím  
H Szervizszekrény szerszámokkal

RO Cutie de service cu scule  
F Servante d'atelier - set d'outils  
I Armadio per utensili  
E Armario para herramientas de servicio  
CN 工具车托盘组套

WHITE  
CARTON BOX  
& COLOR LABEL



141 PCS  
12 TRAY  
WKŁAD

665x453  
x932 mm

7x

BALL BEARING  
ŁOŻYSKA  
KULKOWE

25kg  
35kg  
35kg

DRAWERS  
LOCKING  
BLOKADA  
SZUFLAD

NON SLIP  
POLYPROPYLENE  
WORKTOP  
ANTYPOŚLIZGOWY  
POLIPROPYLENOWY  
BLAT

WHEELS  
KÓŁKA

WHEEL  
KÓŁKA  
125 mm

UNIVERSAL PERFORATION  
UNIWERSALNA  
PERFORACJA

2x  
BRAKE  
HAMULCE

2x1



12 interchangeable trays with YATO tools  
12 wymiennych modułów z narzędziami YATO

**DRAWER / SZUFLADA 1**

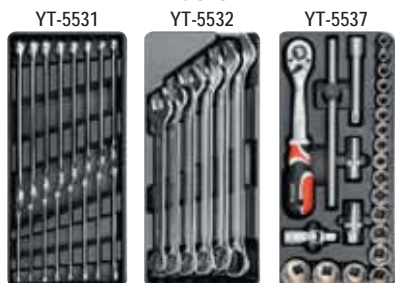

YT-5531

YT-5532

YT-5537

**DRAWER / SZUFLADA 2**

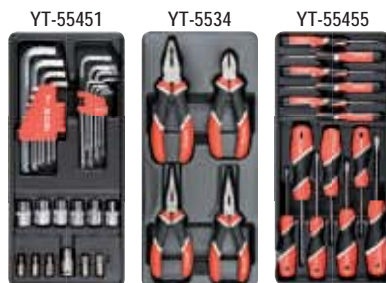

YT-55451

YT-5534

YT-55455

**DRAWER / SZUFLADA 3**



YT-5540

YT-55473

YT-55471

**DRAWER / SZUFLADA 4**



YT-55453

YT-55474

YT-55466

**DRAWER / SZUFLADA 1**

1/2" (127 mm) 10 11 12 13 14 15 16 17 18 19 20 21 22 23 24  
27 30 32 mm Cr 50B 30 1/2" (127 mm) (255 mm)  
72T Cr 6140 1/2" (127 mm) (255 mm) Cr 50B 30  
1/2" (127 mm) (127 mm) Cr 50B 30 1/2" (127 mm)  
Cr 50B 30 6 7 8 9 10 11 12 13 14 15 16 17 18 19  
20 21 mm Cr 22 24 27 28 30 32 mm Cr

**DRAWER / SZUFLADA 2**

1/2" (127 mm) 10 12 14 16 18 20 ( 38 mm) Cr 50B 30  
M5 M6 M7 M10 M12 ( 30 mm) S S2 1/2" (127 mm)  
10 mm Cr 6150 2 2.5 3 4 5 6 7 8 10 12 mm Cr  
6150 T10 T15 T20 T25 T27 T30 T40 T45 T50 Cr 6150  
180 mm 160 mm 160 mm 160 mm ONG  
NOS 160 mm B NT NOS 3 7.5 4 100  
5 7.5 6 100 mm S2 1.4 50 2.0 50 2.4 50 mm PH00 50  
PH0 50 PH1 50 mm S2 PH0 75 PH1 75 PH2 100 mm S2

**DRAWER / SZUFLADA 3**

300 ( 300 mm) 40 mm ( 350 mm)  
10 8 142 mm 12 10 152 mm 16 13 172 mm 250 mm Cr  
125 mm CrMo 300 mm Cr 140 mm  
200 mm 19 mm 20 mm 4 190 mm  
250 10 15 20 25 30 35 40 45 50 55 60 65  
70 75 80 85 90 95 100 mm

**DRAWER / SZUFLADA 4**

#2 200 mm #2 200 mm  
#2 200 mm #2 200 mm  
#2 200 mm  
300 mm 0-150 mm  
2 m  
3m 16 mm 0 02-100 mm  
2.4 3.2 4.0 4.8 mm  
9.6 3.2 9.6 4.0 12.7 4.0 9.6 4.8 12.7 4.8 mm

<b>YATO</b>	drawers / szuflady	
YT-55291	7	1

GB Service cabinet with tools  
 D Serviceschrank mit Werkzeugen  
 PL Szafka serwisowa z narzędziami  
 RUS Сервисный шкаф с инструментами  
 CZ Servisní skříňka s náradím  
 H Szervizszekrény szerszámokkal

RO Cutie de service cu scule  
 F Servante d'atelier - set d'outils  
 I Armadio per utensili  
 E Armario para herramientas de servicio  
 CN 工具车托盘组套

WHITE  
 CARTON BOX  
 & COLOR LABEL



<b>165</b> PCS <b>13</b> TRAY WKLAD	<b>958x766</b> x465 mm	<b>7x</b> BALL BEARING ŁOŻYSKA KULKOWE	<b>WHEELS</b> KÓŁKA Ø 125 mm
<b>3x</b> DRAWERS LOCKING BLOKADA SZUFLAD	<b>NON SLIP</b> POLYPROPYLENE WORKTOP ANTYPOŚLIZGOWY POLIPROPYLENOWY BLAT	<b>WHEELS</b> KÓŁKA Ø 125 mm	<b>2x</b> BRAKE HAMULCE
<b>3x</b> KEY	<b>UNIVERSAL PERFORATION</b> UNIWERSALNA PERFORACJA	<b>DOUBLE WALLS</b> PODWÓJNE SCIANY	<b>CORNER BUMPERS</b> NARÓŻNE ODBOJNIKI



**13 interchangeable trays with YATO tools**  
**13 wymiennych modułów z narzędziami YATO**

**DRAWER / SZUFLADA 1**

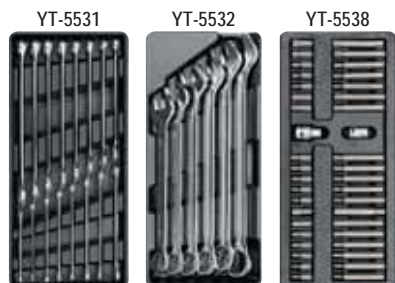

**DRAWER / SZUFLADA 2**

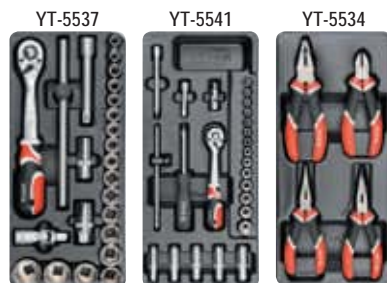

**DRAWER / SZUFLADA 3**

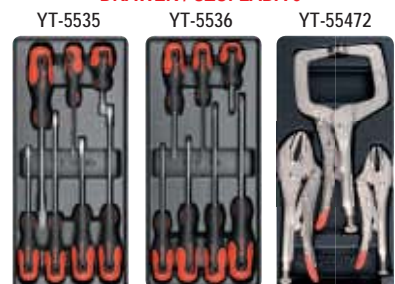

**DRAWER / SZUFLADA 4**



**DRAWER / SZUFLADA 5**



**DRAWER / SZUFLADA 1**

○ □ □ □ H4 H5 H6 H7 H8 H10 H12 ( 30 mm) H4 H5 H6 H7 H8 H10 H12 ( 75 mm) S S2 ○ □ □ □ M5 M6 M7 M10 M12 ( 30 mm) M5 M6 M7 M10 M12 ( 75 mm) S S2 □ □ □ □ T20 T25 T30 T40 T45 T50 T55 ( 30 mm) T20 T25 T30 T40 T45 T50 T55 ( 75 mm) S S2 □ □ □ □ 1/2" (127 mm) 3/8" (95 mm) □ □ □ □ 6 7 8 9 10 11 12 13 14 15 16 17 18 19 20 21 mm Cr □ □ □ □ 22 24 27 28 30 32 mm Cr

**DRAWER / SZUFLADA 2**

□ □ □ □ 1/2" (127 mm) 10 11 12 13 14 15 16 17 18 19 20 21 22 23 24 27 30 32 mm Cr 50B 30 □ □ □ □ 1/2" (127 mm) (255 mm) 72T Cr 6140 □ □ □ □ 1/2" (127 mm) (255 mm) Cr 50B 30 □ □ □ □ 1/2" (127 mm) (127 mm) Cr 50B 30 □ □ □ □ 1/2" (127 mm) Cr 50B 30 □ □ □ □ 1/4" (6.3 mm) 8 10 11 12 13 mm Cr 50B 30 □ □ □ □ 1/4" (6.3 mm) (50.8 101.6 mm) Cr 6140 □ □ □ □ 1/4" (6.3 mm) Cr 50B 30 □ □ □ □ 1/4" (6.3 mm) (155 mm) 72T Cr 6140 □ □ □ □ 1/4" (6.3 mm) (150 mm) Cr 50B 30 □ □ □ □ 1/4" (6.3 mm) (152.4 mm) Cr 50B 30 □ □ □ □ 180 mm □ □ □ □ 160 mm □ □ □ □ 160 mm ONGNOS □ □ □ □ 160 mm B NT NOS

**DRAWER / SZUFLADA 3**

□ □ □ □ 3 75 5 100 5 150 6 38 6 100 6 150 8 150 mm CrMo □ □ □ □ PH0 100 PH1 75 PH1 100 PH2 38 PH2 100 PH2 150 PH3 150 mm CrMo □ □ □ □ 180 250 mm □ □ □ □ 280 mm

**DRAWER / SZUFLADA 4**

□ □ □ □ 3/4" (19.0 mm) 21 22 24 27 28 29 30 32 34 36 41 46 50 55 mm Cr 50B 30 □ □ □ □ 3/4" (19.0 mm) (200 mm) Cr 6140 □ □ □ □ 3/4" (19.0 mm) Cr 50B 30 □ □ □ □ 3/4" (19.0 mm) (500 mm) 72T Cr 6140 □ □ □ □ 3/4" (19.0 mm) (500 mm) Cr 50B 30

**DRAWER / SZUFLADA 5**

○ □ □ □ 1/2" (127 mm) 5/16" (7.9 mm) □ □ □ □ PH3 ( 35 mm) PH1 PH2 PH3 ( 75 mm) □ □ □ □ 8 mm ( 35 mm) 8 mm ( 75 mm) □ □ □ □ 12-38 mm □ □ □ □ 3" (75 mm) □ □ □ □ 82 mm □ □ □ □ 200 mm □ □ □ □ 135 mm □ □ □ □ 300 400 500 mm

<b>YATO</b>	<b>drawers / szuflady</b>	
YT-55293	7	1

GB Service oo cabine wi h oos  
D Serviceschrank mi erkzeu en  
PL Szafka serwisowa z narzędziami  
RUS Сервисный шкаф с инструментами  
CZ Servisní skříňka s nářadím  
H Szervizszekrény szerszámokkal

RO Cutie de service cu scule  
F Servante d'atelier - set d'outils  
I Armadio per utensili  
E Armario para herramientas de servicio  
CN 工具车托盘组套

WHITE  
CARTON BOX  
& COLOR LABEL



177 PCS  
12 TRAY WKŁAD

958x766  
x465 mm

6x

BALL BEARING  
ŁOŻYSKA  
KULKOWE

28kg  
35kg  
35kg

DRAWERS  
LOCKING  
BLOKADA  
SZUFLAD

NON SLIP  
POLYPROPYLENE  
WOKTOP  
ANTYPRZYLEPNY  
BLAT

WHEELS  
KÓŁKA

WHEEL  
KÓŁKA 125  
mm

UNIVERSAL  
PERFORATION  
UNIWEKRSALNA  
PERFORACJA

2x  
BRAKE  
HAMULCE

2x

DOUBLE  
WALLS  
PODWÓJNE  
SCIANY

CORNER BUMPERS  
NARÓZNE ODBOJNIKI



12 interchangeable trays with YATO tools  
12 wymiennych modułów z narzędziami YATO

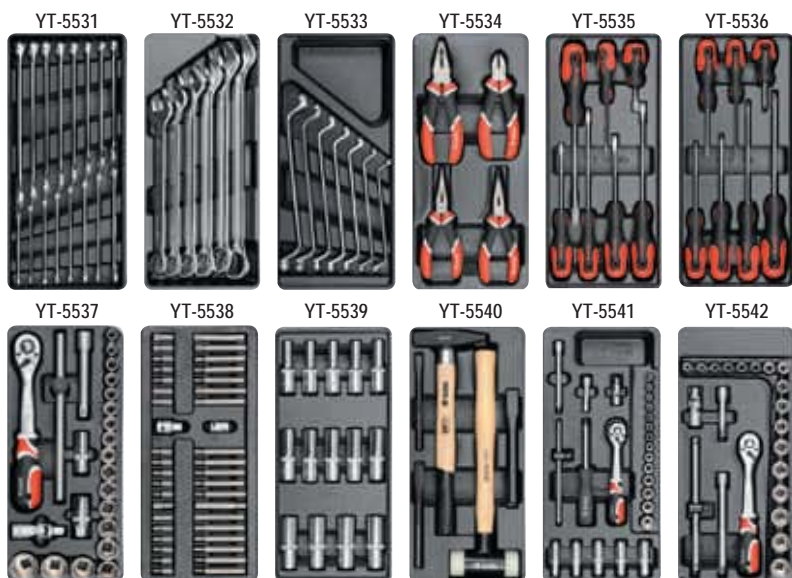

**DRAWER / SZUFLADA 1**

3/8" (9.5 mm) 6 7 8 9 10 11 12 13 14 15 16 17 18 19 20 21 22 mm Cr 50B 30  
3/8" (9.5 mm) Cr 50B 30  
7/2T Cr 6140  
1/2" (12.7 mm) 10 11 12 13 14 15 16 17 18 19 20 21 22 23 24 27 30 32 mm Cr 50B 30  
1/2" (12.7 mm) Cr 50B 30  
1/2" (12.7 mm) 72T Cr 6140  
1/2" (12.7 mm) 16 21 mm Cr 50B 30  
1/4" (6.3 mm) 3 5 4 5 5 5 6 7 8 9 10 11 12 13 14 mm Cr 50B 30  
1/4" (6.3 mm) 8 10 11 12 13 mm Cr 50B 30  
1/4" (6.3 mm) (50.8 101.6 mm) Cr 6140  
1/4" (6.3 mm) Cr 50B 30  
1/4" (6.3 mm) (155 mm) 72T Cr 6140  
1/4" (6.3 mm) (150 mm) Cr 50B 30  
1/4" (6.3 mm) (152.4 mm) Cr 50B 30

**DRAWER / SZUFLADA 2**

3 75 5 100 5 150 6 38 6 100 6 150 8 150 mm CrMo  
PH0 100 PH1 75 PH1 100 PH2 38 PH2 100  
PH2 150 PH3 150 mm CrMo  
160 mm  
160 mm ONG NOS  
160 mm B NT NOS

**DRAWER / SZUFLADA 3**

22 24 27 28 30 32 mm Cr  
12 13 14 15 16 17 18 19 20 21 mm Cr  
10 11 12 13 14 15 16 17 18 19 20 21 mm ( 76 mm) Cr 50B 30

**DRAWER / SZUFLADA 4**

300 ( 300 mm) 40 mm ( 350 mm)  
10 8 142 mm 12 10 152 mm 16 13 172 mm  
H4 H5 H6 H7 H8 H10 H12 ( 75 mm) S  
S2 M5 M6 M7 M10 M12 ( 30 mm) M5 M6 M7 M10 M12  
( 75 mm) S S2 T20 T25 T30 T40 T45 T50 T55 ( 30 mm)  
T20 T25 T30 T40 T45 T50 T55 ( 75 mm) S S2 1/2" (12.7 mm)  
3/8" (9.5 mm) 6 7 8 9 10 11 12 13 14 15 16 17 18 19 mm Cr

YATO	drawers / szuflady	
YT-5530	6	1

GB Service cabinet with tools  
 D Serviceschrank mit Werkzeugen  
 PL Szafka serwisowa z narzędziami  
 RUS Сервисный шкаф с инструментами  
 CZ Servisní skříňka s nářadím  
 H Szervizszekrény szerszámokkal

RO Cutie de service cu scule  
 F Servante d'atelier - set d'outils  
 I Armadio per utensili  
 E Armario para herramientas de servicio  
 CN 工具车托盘组套

WHITE  
 CARTON BOX  
 & COLOR LABEL



<b>189 PCS</b> 14 TRAY WKFLAD	<b>958x766</b> x465 mm	<b>7x</b>	<b>BALL BEARING</b> ŁOŻYSKA KULKOWE	<b>25kg</b> 35kg 35kg
<b>DRAWERS LOCKING</b> BLOKADA SZUFLAD	<b>NON SLIP POLYPROPYLENE WORKTOP</b> ANTYPOŚLIZGOWY POLIPROPILENOWY BLAT	<b>WHEELS</b> KÓŁKA	<b>WHEELS Ø</b> KÓŁKA 125 mm	
<b>UNIVERSAL PERFORATION</b> UNIWERSALNA PERFORACJA	<b>DOUBLE WALLS</b> PODWOJNE SCIANY	<b>3x</b>	<b>2x BRAKE</b> HAMULCE	<b>CORNER BUMPERS</b> NAROŻNE ODBOJNIKI



**DRAWER / SZUFLADA 1**

○ H4 H5 H6 H7 H8 H10 H12 ( 30 mm) H4 H5 H6 H7 H8 H10 H12 ( 75 mm) S S2 ○ M5 M6 M7 M10 M12 ( 30 mm) M5 M6 M7 M10 M12 ( 75 mm) S S2 ○ T20 T25 T30 T40 T45 T50 T55 ( 30 mm) T20 T25 T30 T40 T45 T50 T55 ( 75 mm) S S2 ○ 1/2" (12.7 mm) 3/8" (9.5 mm) 6 7 8 9 10 11 12 13 14 15 16 17 18 19 20 21 mm Cr ○ 22 24 27 28 30 32 mm Cr

**DRAWER / SZUFLADA 2**

○ 1/2" (12.7 mm) 10 11 12 13 14 15 16 17 18 19 20 21 22 23 24 27 30 32 mm Cr 50B 30 ○ 1/2" (12.7 mm) (255 mm) 72T Cr 6140 ○ 1/2" (12.7 mm) (127 mm) Cr 50B 30 ○ 1/2" (12.7 mm) Cr 50B 30 ○ 180 mm 160 mm 160 mm ONG NOS 160 mm B NT NOS 300 ( 300 mm) 40 mm ( 350 mm) 10 8 142 mm 12 10 152 mm 16 13 172 mm

**DRAWER / SZUFLADA 3**

○ 3 75 4 100 5 75 6 100 mm S2 ○ 14 50 20 50 24 50 mm PH00 50 PH0 50 PH1 50 mm PH0 75 PH1 75 PH2 100 mm S2 ○ 200 250 mm Cr ○ 250 mm Cr/Mo ○ 180 mm Cr

**DRAWER / SZUFLADA 4**

○ 3 M3 05 M4 07 M5 08 M6 10 M7 10 M8 125 M10 15 M12 175 ○ M3 05 M4 07 M5 08 M6 10 M7 10 M8 125 M10 15 M12 175 ○ 05 1.75 mm 27G 28G ○ M7-M9 ○ M3-M12 ○ 180 mm XT RN STR GHT ○ 180 mm NT RN STR GHT ○ 180 mm XT RN B NT ○ 180 mm NT RN B NT ○ #2 200 mm □ #2 200 mm △ #2 200 mm ○ #2 200 mm ○ #2 200 mm

**DRAWER / SZUFLADA 5**

○ 140 mm ○ 19 mm 20 mm ○ 4 190 mm 250 ○ 10 15 20 25 30 35 40 45 50 55 60 65 70 75 80 85 90 95 100 mm ○ 1" (25 mm) 330 mm ○ 250 mm ○ 24 32 40 48 mm ○ 96 32 96 40 127 48 mm

<b>YATO</b>	<b>drawers / szuflady</b>	
YT-55292	7	1

**14 interchangeable trays with YATO tools**  
**14 wymiennych modułów z narzędziami YATO**

**DRAWER / SZUFLADA 1**

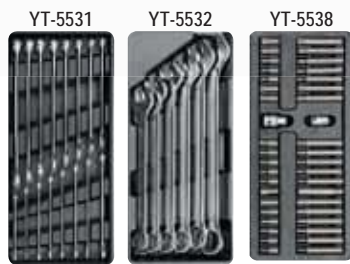

**DRAWER / SZUFLADA 2**

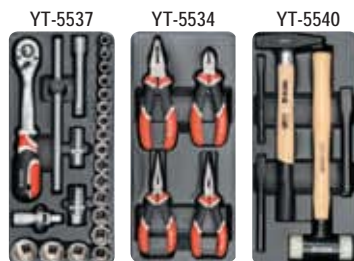

**DRAWER / SZUFLADA 3**



**DRAWER / SZUFLADA 4**



**DRAWER / SZUFLADA 5**



GB Service oo cabine wi h oo s  
D Serviceschrank mi erkezu en  
PL Szafka serwisowa z narzędziami  
RUS Сервисный шкаф с инструментами  
CZ Servisní skříňka s nářadím  
H Szervizszekrény szerszámokkal

RO Cutie de service cu scule  
F Servante d'atelier - set d'outils  
I Armadio per utensili  
E Armario para herramientas de servicio  
CN 工具车托盘组套

WHITE  
CARTON BOX  
& COLOR LABEL



211 PCS  
5 TRAY  
WKŁAD

980x770  
x465 mm

7x

BALL BEARING  
ŁOŻYSKA  
KULKOWE

25kg  
35kg

DRAWERS  
LOCKING  
BLOKADA  
SZUFLAD

NON SLIP  
POLYPROPYLENE  
WOKRTOP  
ANTIPOŚLIZGOWY  
POLIPROPYLENOWY  
BLAT

WHEELS  
KÓŁKA

WHEEL Ø  
125 mm

UNIVERSAL  
PERFORATION  
UNIWERSALNA  
PERFORACJA

DOUBLE  
WALLS  
PODWÓJNE  
SCIANY

3xT

2x  
BRAKE  
HAMULCE

CORNER BUMPERS  
NARÓŻNE ODBOJNIKI



**DRAWER / SZUFLADA 1**

1/2" (12.7 mm) 8 9 10 11 12 13 14 15 16 17 18 19 20 21 22  
24 ( 38 mm) 27 30 32 mm ( 42 mm) 1/4" (6.3 mm) 4 4.5 5 5.5 6  
7 8 9 10 11 12 13 ( 25 mm) Cr 50B 30 1/2" (12.7 mm) 10  
13 14 15 17 19 21 mm ( 76 mm) 1/4" (6.3 mm) 6 7 8 9 10 11 12  
13 ( 50 mm) Cr 50B 30 1/2" (12.7 mm) 10 11 12 14 16  
1/4" (6.3 mm) 4 5 6 7 8 Cr 50B 30 1/2" (12.7 mm)  
(127 254 mm) 1/4" (6.3 mm) (50.8 101.6 mm) Cr 50B 30 1/2"  
(12.7 mm) Cr 50B 30 1/2" (12.7 mm) 16 21 mm Cr 50B 30  
1/2" (12.7 mm) (255 mm) 1/4" (6.3 mm) (152.4 mm)  
Cr 50B 30 1/2" (12.7 mm) (255 mm) 1/4" (6.3 mm)  
(155 mm) Cr 6140 1/4" (6.3 mm) (150 mm) Cr 50B 30  
1/4" (6.3 mm) 4 5.5 6.5 mm S S2 / Cr 6150 1/4"  
1/4" (6.3 mm) PH1 ( 2) PH2 ( 2) PH3 S S2 / Cr 6150 1/4"  
(6.3 mm) PZ1 PZ2 PZ3 S S2 / Cr 6150 1/4" (6.3 mm) T8  
T10 T15 T20 T25 T30 T40 S S2 / Cr 6150 1/4" (6.3 mm)  
3 4 5 6 7 8 mm S S2 / Cr 6150

**DRAWER / SZUFLADA 2**

200 mm Cr 3-6 mm ( 52 mm) 6-8  
( 58 mm) 8-11 ( 66 mm) 11-14 ( 75 mm) 14-18 ( 80 mm)  
18-25 ( 88 mm) 8 9 10 11 12 13 14 15 16 17  
18 19 21 22 24 mm Cr T10 T15 T20 T25 T27 T30  
T40 T45 T50 Cr 6150 2 2.5 3 4 5 6 7 8 10 12 mm  
Cr 6150

**DRAWER / SZUFLADA 3**

60 38 20 75 30 75 40 100 50 100 60 100 mm  
PH0 100 PH1 100 PH2 38 PH2 150 PH3 150 mm T7 75 T8 75 T9 75  
T10 100 T15 100 T20 100 T25 100 T27 100 mm S2 60 150 mm PH2 150 mm Cr 6150

**DRAWER / SZUFLADA 4**

180 mm 160 mm 200 mm  
250 mm 400 340  
12.5 152 16.0 172 mm Cr 6150 30 150 40 150  
50 150 60 150 80 150 mm Cr 6150 80 112 mm  
Cr 6150

**DRAWER / SZUFLADA 5**

M3 0.5 ( 3) M4 0.7 ( 3) M5 0.8 ( 3) M6 1.0 ( 3) M7 1.0  
( 3) M8 1.25 ( 3) M10 1.5 ( 3) M12 1.75 ( 3) HSS M2  
M3 M4 0.7 M5 0.8 M6 1.0 M7 1.0 M8 1.25 M10 1.5 M12 1.75  
HSS M2 M7-M9 M3-M12  
#2 200 mm  
#2 200 mm  
#2 200 mm  
300 mm D 3 m 16 mm  
0-150 mm

<b>YATO</b>	drawers / szuflady	
YT-55290	7	1

**DRAWER / SZUFLADA 1**



**DRAWER / SZUFLADA 2**

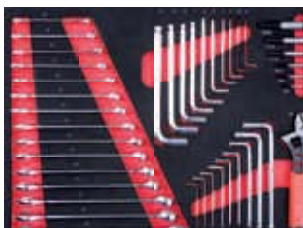

**DRAWER / SZUFLADA 3**



**DRAWER / SZUFLADA 4**



**DRAWER / SZUFLADA 5**

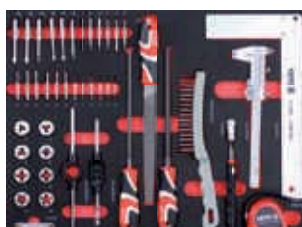

## CREATE YOUR WORKPLACE - STWÓRZ SWOJE MIEJSCE PRACY

YT-09061



YT-09951



YT-09952



YT-08922



YT-08921



YT-08920



- GB Too ches
- D erkzeu kas en
- PL Szafka warsz a owa
- RUS Портативный ящик для инструментов
- CZ Přenosná skříňka na nářadí
- H Hordozható szerszámós láda
- RO Cutie pt. instrumente portabile
- F Servante d'atelier
- I Banco da lavoro armadio
- E Cajonera portátil
- CN 馱檢齧



WHITE  
CARTON BOX  
& COLOR LABEL



690x465  
x400 mm



YATO	drawers / szuflady	
YT-09151	3	1

- GB Too ches
- D erkzeu kas en
- PL Szafka warsz a owa
- RUS Портативный ящик для инструментов
- CZ Přenosná skříňka na nářadí
- H Hordozható szerszámós láda
- RO Cutie pt. instrumente portabile
- F Servante d'atelier
- I Banco da lavoro armadio
- E Cajonera portátil
- CN 馱檢齧



WHITE  
CARTON BOX  
& COLOR LABEL



690x465  
x400 mm



YATO	drawers / szuflady	
YT-09152	4	1

- GB Too ches
- D erkzeu kas en
- PL Szafka warsz a owa
- RUS Портативный ящик для инструментов
- CZ Přenosná skříňka na nářadí
- H Hordozható szerszámós láda
- RO Cutie pt. instrumente portabile
- F Servante d'atelier
- I Banco da lavoro armadio
- E Cajonera portátil
- CN 馱檢齧



WHITE  
CARTON BOX  
& COLOR LABEL



690x465  
x535 mm



YATO	drawers / szuflady	
YT-09155	6	1



GB Ro er cabine  
D erks a ro wa en  
PL Szafka serwisowa  
RUS Инструментальный кабинет  
CZ Dílenská skříňka  
H Görgös szerszámtároló  
RO Dulap de scule  
F Servante d'atelier  
I Armadio per utensili  
E Armario en ruedas  
CN 工具车



1130x570 x1000 mm	6x	BALL BEARING ŁOŻYSKA KULKOWE	25kg 35kg 35kg
OIL PROOF STEEL WORKTOP OLEJODOPORNY STALOWY BLAT	DRAWERS LOCKING BLOKADA SZUFLAD	WHEELS KÓŁKA	WHEEL KÓŁKA 160 mm
UNIVERSAL PERFORATION UNIWERSALNA PERFORACJA	2x T	2x BRAKE HAMULCE	
DOUBLE WALLS PODWÓJNE SCIANY	CORNER BUMPERS NAROŻNE ODBOJNIKI		

WHITE  
CARTON BOX  
& COLOR LABEL

<b>YATO</b>	drawers / szuflady	1
YT-09001	6	1

GB Ro er cabine  
D erks a ro wa en  
PL Szafka serwisowa  
RUS Инструментальный кабинет  
CZ Dílenská skříňka  
H Görgös szerszámtároló  
RO Dulap de scule  
F Servante d'atelier  
I Armadio per utensili  
E Armario en ruedas  
CN 工具车



1130x570 x1000 mm	6+1	BALL BEARING ŁOŻYSKA KULKOWE	25kg 35kg 35kg
OIL PROOF STEEL WORKTOP OLEJODOPORNY STALOWY BLAT	DRAWERS LOCKING BLOKADA SZUFLAD	WHEELS KÓŁKA	WHEEL KÓŁKA 160 mm
UNIVERSAL PERFORATION UNIWERSALNA PERFORACJA	2x T	2x BRAKE HAMULCE	
DOUBLE WALLS PODWÓJNE SCIANY	CORNER BUMPERS NAROŻNE ODBOJNIKI		

WHITE  
CARTON BOX  
& COLOR LABEL

<b>YATO</b>	drawers / szuflady	1
YT-09002	6 1	1

GB Ro er cabine  
D erks a ro wa en  
PL Szafka serwisowa  
RUS Инструментальный кабинет  
CZ Dílenská skříňka  
H Görgös szerszámtároló  
RO Dulap de scule  
F Servante d'atelier  
I Armadio per utensili  
E Armario en ruedas  
CN 工具车



1130x570 x1000 mm	12x	BALL BEARING ŁOŻYSKA KULKOWE	25kg 35kg 35kg
OIL PROOF STEEL WORKTOP OLEJODOPORNY STALOWY BLAT	DRAWERS LOCKING BLOKADA SZUFLAD	WHEELS KÓŁKA	WHEEL KÓŁKA 160 mm
UNIVERSAL PERFORATION UNIWERSALNA PERFORACJA	2x T	2x BRAKE HAMULCE	
DOUBLE WALLS PODWÓJNE SCIANY	CORNER BUMPERS NAROŻNE ODBOJNIKI		

WHITE  
CARTON BOX  
& COLOR LABEL

<b>YATO</b>	drawers / szuflady	1
YT-09003	12	1

GB Ro er cabine  
 D erks a ro wa en  
 PL Szafka serwisowa  
 RUS Инструментальный кабинет  
 CZ Dilenská skříňka  
 H Görgös szerszámátároló  
 RO Dulap de scule  
 F Servante d'atelier  
 I Armadio per utensili  
 E Armario en ruedas  
 CN 工具车

995x680  
x458mm

4x

**DRAWERS LOCKING**  
BLOKADA SZUFLAD

**CENTRAL LOCK**  
CENTRALNY ZAMEK

300kg  
max.

**BALL BEARING**  
ŁOŻYSKA KULKOWE

**WHEELS**  
TÓLKA

**WHEELS**  
127 mm  
→1" (25.4 mm)

**NON SLIP POLYPROPYLENE WORKTOP**  
ANTYPOŚLIZGOWY POLIPROPYLENOWY BLAT

4xT

2x  
**BRAKE**  
HAMULCE



<b>YATO</b>	drawers / szuflady	1
YT-0912	4	1

GB Ro er cabine  
 D erks a ro wa en  
 PL Szafka serwisowa  
 RUS Инструментальный кабинет  
 CZ Dilenská skříňka  
 H Görgös szerszámátároló  
 RO Dulap de scule  
 F Servante d'atelier  
 I Armadio per utensili  
 E Armario en ruedas  
 CN 工具车

995x680  
x458mm

6x

**DRAWERS LOCKING**  
BLOKADA SZUFLAD

**CENTRAL LOCK**  
CENTRALNY ZAMEK

300kg  
max.

**BALL BEARING**  
ŁOŻYSKA KULKOWE

**WHEELS**  
TÓLKA

**WHEELS**  
127 mm  
→1" (25.4 mm)

**NON SLIP POLYPROPYLENE WORKTOP**  
ANTYPOŚLIZGOWY POLIPROPYLENOWY BLAT

2xT

2x  
**BRAKE**  
HAMULCE



<b>YATO</b>	drawers / szuflady	1
YT-0913	6	1

GB Ro er cabine  
 D erks a ro wa en  
 PL Szafka serwisowa  
 RUS Инструментальный кабинет  
 CZ Dilenská skříňka  
 H Görgös szerszámátároló  
 RO Dulap de scule  
 F Servante d'atelier  
 I Armadio per utensili  
 E Armario en ruedas  
 CN 工具车

995x680  
x458mm

7x

**DRAWERS LOCKING**  
BLOKADA SZUFLAD

**CENTRAL LOCK**  
CENTRALNY ZAMEK

**NON SLIP POLYPROPYLENE WORKTOP**  
ANTYPOŚLIZGOWY POLIPROPYLENOWY BLAT

300kg  
max.

**BALL BEARING**  
ŁOŻYSKA KULKOWE

**WHEELS**  
TÓLKA

**WHEELS**  
127 mm  
→1" (25.4 mm)

2x  
**BRAKE**  
HAMULCE

2xT



<b>YATO</b>	drawers / szuflady	1
YT-0914	7	1

GB Ro er cabine  
 D erks a ro wa en  
 PL Szafka serwisowa  
 RUS Инструментальный кабинет  
 CZ Dilenská skříňka  
 H Görgös szerszámátároló  
 RO Dulap de scule  
 F Servante d'atelier  
 I Armadio per utensili  
 E Armario en ruedas  
 CN 工具车

958x766  
x465 mm

**DRAWERS LOCKING**  
BLOKADA SZUFLAD

**NON SLIP POLYPROPYLENE WORKTOP**  
ANTYPOŚLIZGOWY POLIPROPYLENOWY BLAT

**BALL BEARING**  
ŁOŻYSKA KULKOWE

**WHEELS**  
TÓLKA

**UNIVERSAL PERFORMANCE**  
UNIWERSALNA PERFORACJA

**DOUBLE WALLS**  
PODWÓJNE ŚCIANY

**CORNER BUMPERS**  
NAROŻNE ODBOJNIKI



<b>YATO</b>	drawers / szuflady	1
YT-0902	6	1
YT-0903	7	1

GB Ro er cabine  
D erks a ro wa en  
PL Szafka serwisowa  
RUS Инструментальный кабинет  
CZ Dilenská skříňka  
H Görgös szerszámtároló  
RO Dulap de scule  
F Servante d'atelier  
I Armadio per utensili  
E Armario en ruedas  
CN 工具车



WHITE  
CARTON BOX  
& COLOR LABEL

<b>YATO</b>	drawers / szuflady	1
YT-0904	7	1

GB Ro er cabine  
D erks a ro wa en  
PL Szafka serwisowa  
RUS Инструментальный кабинет  
CZ Dilenská skříňka  
H Görgös szerszámtároló  
RO Dulap de scule  
F Servante d'atelier  
I Armadio per utensili  
E Armario en ruedas  
CN 工具车



WHITE  
CARTON BOX  
& COLOR LABEL

<b>YATO</b>	drawers / szuflady	1
YT-09000	7	1

GB Ro er cabine  
D erks a ro wa en  
PL Szafka serwisowa  
RUS Инструментальный кабинет  
CZ Dilenská skříňka  
H Görgös szerszámtároló  
RO Dulap de scule  
F Servante d'atelier  
I Armadio per utensili  
E Armario en ruedas  
CN 工具车

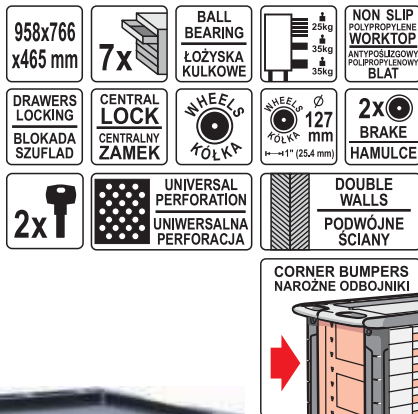

WHITE  
CARTON BOX  
& COLOR LABEL

<b>YATO</b>	drawers / szuflady	1
YT-09031	7	1

GB Ro er cabine  
D erks a ro wa en  
PL Szafka serwisowa  
RUS Инструментальный кабинет  
CZ Dilenská skříňka  
H Görgös szerszámtároló  
RO Dulap de scule  
F Servante d'atelier  
I Armadio per utensili  
E Armario en ruedas  
CN 工具车

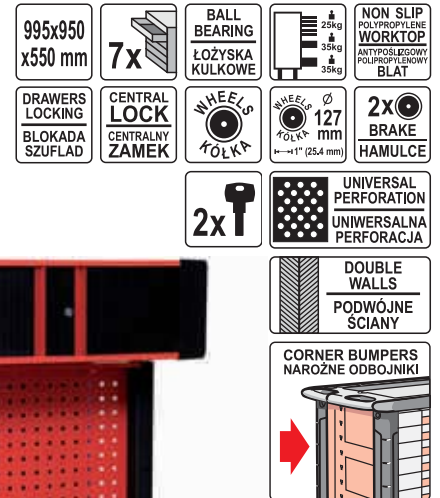

WHITE  
CARTON BOX  
& COLOR LABEL

<b>YATO</b>	drawers / szuflady	1
YT-09008	7	1

GB Shu er cabine  
 D erks a Hän eschrank  
 PL Szafka wisząca  
 RUS Шкафчик  
 для инструмента  
 настенный  
 CZ Závěsná skříňka  
 H Szerszámtároló  
 RO Raft de scule  
 F Placard d'atelier  
 I Scaffa e  
 E rmario co an e  
 CN 橙螯揣



1375x714  
x145 mm

**CENTRAL LOCK**  
CENTRALNY ZAMEK



**UNIVERSAL PERFORMANCE**  
UNIWEERSALNA PERFORACJA

WHITE  
CARTON BOX  
& COLOR LABEL



YATO	size / rozmiar (mm)	
YT-09061	1375 714 145	1

GB orkbench  
 D erkbank  
 PL Stół warsztatowy  
 RUS Верстак  
 CZ Pracovní stůl  
 H Munkapad  
 RO Banc de lucru  
 F Table d'atelier  
 I Banco da lavoro  
 E Banco de trabajo  
 CN 工作台



1500x780  
x830 mm

**NON SLIP ABS WORKTOP**  
ANTYPOŚLIZGOWY BLAT Z TWORZYWA ABS

WHITE  
CARTON BOX  
& COLOR LABEL



YATO	size / rozmiar (mm)	
YT-08920	1500 780 830	1

GB Drawer insert / Combination spanners  
 D Schubladeneinlage / Schrauben- und Ringschlüssel  
 PL Wkład do szuflady / Klucze płasko-oczkowe  
 RUS Вклад к выдвигному ящику / Плоско-закрытый накладной ключ  
 CZ Vložka do zásuvky / Klíče ploché-očkové  
 H Fiókbetét / Kombinált kulcsok  
 RO Adaos la sertar / Chei plane - inelare  
 F Module plastique pour servante avec clés mixtes  
 I Tenone per l'armadio chiavi  
 E Accesorio de cajón / Llave española de muletilla  
 CN 两用扳手托盘组套

PLASTIC TRAY & COLOR LABEL



**CrV**

GB Drawer insert / Bi-hexagonal ring spanner  
 D Schubladeneinlage / Doppelringschlüssel  
 PL Wkład do szuflady / Klucze oczkowe odgięte  
 RUS Вклад к выдвигному ящику / Ключ накидной изогнутый  
 CZ Vložka do zásuvky / Klíče očkové ohnuté  
 H Fiókbetét / Hajlítotszárú csillagkulcs  
 RO Adaos la sertar / Chei inelaro-curbată  
 F Module plastique pour servante clés contre-coudées  
 I Tenone per l'armadio chiavi  
 E Accesorio de cajón / Llave de estrella  
 CN 双头高颈梅花扳手托盘组套

PLASTIC TRAY & COLOR LABEL



**CrV**

16



6  
PCS

22 24 27 28 30 32 mm Cr

YATO	
YT-5532	4

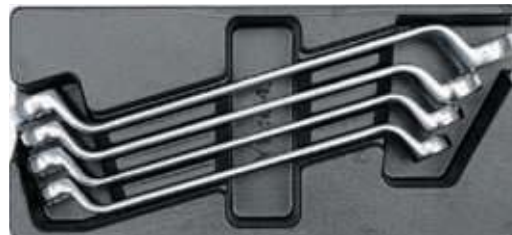

4  
PCS

21 23 24 27 28 30 32 mm Cr

YATO	
YT-5543	8



16  
PCS

6 7 8 9 10 11 12 13 14 15 16 17 18 19 20 21 mm Cr

YATO	
YT-5531	8



7  
PCS

6 7 8 9 10 11 12 13 14 15 16 17 18 19 mm Cr

YATO	
YT-5533	8

- GB Drawer insert / L-type socket wrench  
D Schubladeneinlage / Steckschlüssel gebogen  
PL Wkład do szuflady / Klucz nasadowy typ „L”  
RUS Вклад к выдвижному ящику / Ключ торцевой L-типа  
CZ Vložka do zásuvky / Nástrčný klíč fajfkový  
H Fiókbetét / Kulcs, dugó-pipa  
RO Adaos la sertar / Cheie tubulara cu cot tip „L”  
F Module plastique pour servante / Clé a douille de type „L”  
I Tenone per l'armadio / Chiave a tubo tipo „L”  
E Accesorio de cajón / Llave de vaso „L”  
CN 型套筒扳手托盘组套

PLASTIC TRAY & COLOR LABEL

10  
PCS

CrV



7 8 9 10 11 12 13 14 17 19 mm

**YATO**  
YT-55456 4

- GB Drawer insert / P iers  
D Schubladeneinlage / Zangen  
PL Wkład do szuflady / Szczypce  
RUS Вклад к выдвижному ящику / Клещи  
CZ Vložka do zásuvky / Kleště  
H Fiókbetét / Fogók  
RO Adaos la sertar / Clește  
F Module plastique pour servante avec pinces  
I Tenone per l'armadio / Pinze  
E Accesorio de cajón / Pinzas  
CN 钳子托盘组套

PLASTIC TRAY & COLOR LABEL

4  
PCS

CrV



180 mm 160 mm  
ONG NOS  
160 mm  
B NT NOS

**YATO**  
YT-5534 8

- GB Drawer insert / P iers  
D Schubladeneinlage / Zangen  
PL Wkład do szuflady / Szczypce  
RUS Вклад к выдвижному ящику / Клещи  
CZ Vložka do zásuvky / Kleště  
H Fiókbetét / Fogók  
RO Adaos la sertar / Clește  
F Module plastique pour servante avec pinces  
I Tenone per l'armadio / Pinze  
E Accesorio de cajón / Pinzas  
CN 挡圈钳托盘组套

PLASTIC TRAY & COLOR LABEL

4  
PCS

CrV

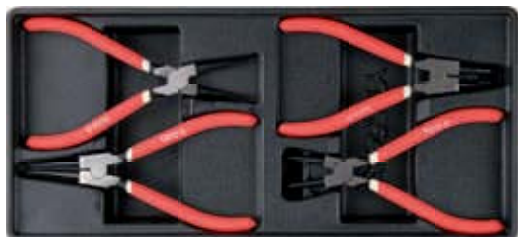

180 mm 180 mm  
XT RN STR GHT NT RN STR GHT  
180 mm 180 mm  
XT RN B NT NT RN B NT

**YATO**  
YT-55443 8

- GB Drawer insert / P iers  
D Schubladeneinlage / Zangen  
PL Wkład do szuflady / Szczypce  
RUS Вклад к выдвижному ящику / Клещи  
CZ Vložka do zásuvky / Kleště  
H Fiókbetét / Fogók  
RO Adaos la sertar / Clește  
F Module plastique pour servante avec pinces  
I Tenone per l'armadio / Pinze  
E Accesorio de cajón / Pinzas  
CN 钳子托盘组套

PLASTIC TRAY & COLOR LABEL

3  
PCS

CrMo

CrV



180 mm 250 mm 250 mm

**YATO**  
YT-55463 8

- GB Drawer insert / P iers  
D Schubladeneinlage / Zangen  
PL Wkład do szuflady / Szczypce  
RUS Вклад к выдвижному ящику / Клещи  
CZ Vložka do zásuvky / Kleště  
H Fiókbetét / Fogók  
RO Adaos la sertar / Clește  
F Module plastique pour servante avec pinces  
I Tenone per l'armadio / Pinze  
E Accesorio de cajón / Pinzas  
CN 钳子托盘组套

PLASTIC TRAY & COLOR LABEL

3  
PCS

CrMo

CrV



180 mm 250 mm 280 mm

**YATO**  
YT-55472 8

- GB Drawer insert / P iers  
D Schubladeneinlage / Zangen  
PL Wkład do szuflady / Szczypce  
RUS Вклад к выдвижному ящику / Клещи  
CZ Vložka do zásuvky / Kleště  
H Fiókbetét / Fogók  
RO Adaos la sertar / Clește  
F Module plastique pour servante avec pinces  
I Tenone per l'armadio / Pinze  
E Accesorio de cajón / Pinzas  
CN 钳子托盘组套

PLASTIC TRAY & COLOR LABEL

3  
PCS

CrMo

CrV



250 mm 125 mm 300 mm

**YATO**  
YT-55473 8

- GB Drawer insert / Pliers and adjustable wrenches  
 D Schubladeneinlage / Zangen und rollgabelschlüssel  
 PL Wkład do szuflady / Szczypce i klucze nastawne  
 RUS Вклад к выдвижному ящику / Клещи и ключ разводной  
 CZ Vložka do zásuvky / Kleště, nastavitelný klíč  
 H Fiókbetét / Fogók és állítható svédkulcs  
 RO Adaos la sertar / Clește și cheie reglabilă  
 F Module plastique pour servante / Pincés et clé a molette  
 I Tenone per l'armadio / Pinze  
 E Accesorio de cajón / Pinzas y llave ajustable  
 CN 活络扳手大力钳托盘组套

PLASTIC TRAY & COLOR LABEL

4  
PCS

CrMo

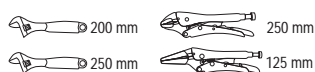

**YATO**  
YT-55444 8

- GB Drawer insert / Pliers  
 D Schubladeneinlage / Zangen  
 PL Wkład do szuflady / Szczypce  
 RUS Вклад к выдвижному ящику / Клещи  
 CZ Vložka do zásuvky / Kleště  
 H Fiókbetét / Fogók  
 RO Adaos la sertar / Clește  
 F Module plastique pour servante avec pincés  
 I Tenone per l'armadio / Pinze  
 E Accesorio de cajón / Pinzas  
 CN 钳子托盘组套

PLASTIC TRAY & COLOR LABEL

4  
PCS

CrV

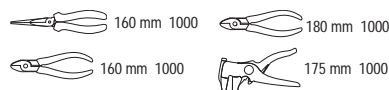

**YATO**  
YT-55464 8

- GB Drawer insert / Slotted screwdrivers  
 D Schubladeneinlage / Flachschauber  
 PL Wkład do szuflady / Wkrętaki płaskie  
 RUS Вклад к выдвижному ящику / Плоские отвертки  
 CZ Vložka do zásuvky / Šroubováky ploché  
 H Fiókbetét / Lapos csavarhúzó  
 RO Adaos la sertar / Șurubelnițe plane  
 F Module plastique pour servante avec tournevis  
 I Tenone per l'armadio / Set di cacciaviti piatti  
 E Accesorio de cajón / Desarmadores planos  
 CN 一字螺丝批托盘组套

PLASTIC TRAY & COLOR LABEL

7  
PCS

CrMo

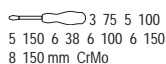
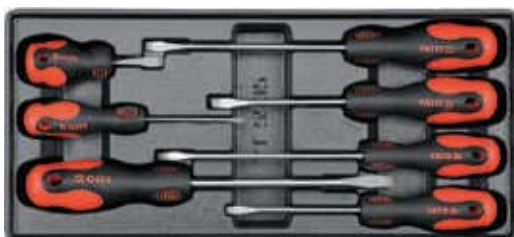
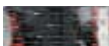

**YATO**  
YT-5535 8

- GB Drawer insert / Phillips screwdrivers  
 D Schubladeneinlage / Kreuzschlitzschrauber  
 PL Wkład do szuflady / Wkrętaki krzyżakowe  
 RUS Вклад к выдвижному ящику / Крестовидные отвертки  
 CZ Vložka do zásuvky / Šroubováky křížové  
 H Fiókbetét / Kereszt csavarhúzó  
 RO Adaos la sertar / Șurubelnițe în cruce  
 F Module plastique pour servante avec tournevis  
 I Tenone per l'armadio / Set di cacciaviti a croce  
 E Accesorio de cajón / Desarmadores de cruz  
 CN 十字螺丝批托盘组套

PLASTIC TRAY & COLOR LABEL

7  
PCS

CrMo

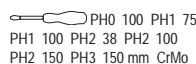

**YATO**  
YT-5536 8

- GB Drawer insert / Screwdriver set  
 D Schubladeneinlage / Schraubendrehersatz  
 PL Wkład do szuflady / Komplet wkrętaków  
 RUS Вклад к выдвижному ящику / Набор отверток  
 CZ Vložka do zásuvky / Zámečnické šroubováky  
 H Fiókbetét / Lakatos csavarhúzó  
 RO Adaos la sertar / Șurubelnițe de lăcătușerie  
 F Module plastique pour servante avec tournevis  
 I Tenone per l'armadio / Set di cacciaviti  
 E Accesorio de cajón / Juego de destornilladores  
 CN 螺丝批托盘组套

PLASTIC TRAY & COLOR LABEL

13  
PCS

S2

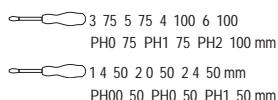

**YATO**  
YT-55455 8

- GB Drawer insert / Go-through screwdrivers  
 D Schubladeneinlage / Schlagschrauber  
 PL Wkład do szuflady / Wkrętaki do pobijania  
 RUS Вклад к выдвижному ящику / Отвертка-било  
 CZ Vložka do zásuvky / Šroubovák s úderným koncem  
 H Fiókbetét / Beütő csavarhúzó  
 RO Adaos la sertar / Șurubelniță pt. fixare  
 F Module plastique pour servante / Allez - par tournevis  
 I Tenone per l'armadio / Set di cacciaviti  
 E Accesorio de cajón / Destornillador para dar golpes  
 CN 穿心螺丝批托盘组套

PLASTIC TRAY & COLOR LABEL

4  
PCS

CrV



**YATO**  
YT-55469 8

GB Drawer insert / Screwdriver set  
D Schubladeneinlage / Schraubendrehersatz  
PL Wkład do szuflady / Komplet wkrętek  
RUS Вклад к выдвижному ящику / Набор отвёрток  
CZ Vložka do zásuvky / Zámečnické šroubováky  
H Fiókbetét / Lakatos csavarhózó  
RO Adaos la sertar / Şurubelnițe de lăcătușerie  
F Module plastique pour servante avec trounevis  
I Tenone per l'armadio / Set di cacciaviti  
E Accesorio de cajón / Juego de destornilladores  
CN 绝缘螺丝批托盘组套

PLASTIC TRAY & COLOR LABEL



8  
PCS

S2



3 75 4 100 5 5 125 6 5 150  
PH1 80 PH2 100 PH3 150 mm 1000  
4 190 mm 250

**YATO**  
YT-55462 8

GB Drawer insert / Too se  
D Schubladeneinlage / Sechskant-Steckschlüssel-Satz  
PL Wkład do szuflady / Zestaw narzędziowy  
RUS Вклад к выдвижному ящику / Набор инструмента  
CZ Vložka do zásuvky / Sada nástrčných kľúčů a ráčny  
H Fiókbetét / Dugókulcs készlet racsnis hajtókarral  
RO Adaos la sertar / Rotrusa chei tubulare cu antrenor  
F Module plastique pour servante / Coffret d'outillage  
I Tenone per l'armadio / Set di utensili  
E Accesorio de cajón / Juego de herramientas  
CN 套筒扳手组套

PLASTIC TRAY & COLOR LABEL



4  
PCS

CrV



3/4" (19.0 mm) (200 mm) Cr 6140  
3/4" (19.0 mm) Cr 50B 30  
3/4" (19.0 mm) (500 mm) 72T Cr 6140  
3/4" (19.0 mm) (500 mm) Cr 50B 30

**YATO**  
YT-55458 4

GB Drawer insert / Socke se  
D Schubladeneinlage / Steckschlüsselsatz  
PL Wkład do szuflady / Zestaw kluczy nasadowych  
RUS Вклад к выдвижному ящику / Торцовые ключи  
CZ Vložka do zásuvky / Kľíče nástrčné  
H Fiókbetét / Dugókulcsok  
RO Adaos la sertar / Duză cheie  
F Module plastique pour servante avec set d'outillages  
I Tenone per l'armadio chiave a bussola  
E Accesorio de cajón / Llaves de cubo  
CN 套筒托盘组套

PLASTIC TRAY & COLOR LABEL



22  
PCS



3/8" (9.5 mm) 6 7 8 9 10 11 12 13 14  
15 16 17 18 19 20 21 22 mm Cr 50B 30  
3/8" (9.5 mm) (76 152.4 mm) Cr 50B 30  
3/8" (9.5 mm) Cr 50B 30  
3/8" (9.5 mm) (200 mm) 72T Cr 6140  
3/8" (9.5 mm) (198 mm) Cr 50B 30

**YATO**  
YT-5542 8

GB Drawer insert / Socke se  
D Schubladeneinlage / Steckschlüsselsatz  
PL Wkład do szuflady / Zestaw kluczy nasadowych  
RUS Вклад к выдвижному ящику / Торцовые ключи  
CZ Vložka do zásuvky / Kľíče nástrčné  
H Fiókbetét / Dugókulcsok  
RO Adaos la sertar / Duză cheie  
F Module plastique pour servante avec set d'outillages  
I Tenone per l'armadio chiave a bussola  
E Accesorio de cajón / Llaves de cubo  
CN 套筒托盘组套

PLASTIC TRAY & COLOR LABEL



25  
PCS



1/4" (6.3 mm) 3 5 4 4 5 5 5 6 7 8 9 10 11 12 13 14  
mm Cr 50B 30 1/4" (6.3 mm) 8 10 11 12 13 mm Cr  
50B 30 1/4" (6.3 mm) (50.8 101.6 mm) Cr 6140  
1/4" (6.3 mm) Cr 50B 30 1/4" (6.3 mm) (155 mm)  
72T Cr 6140 1/4" (6.3 mm) (150 mm) Cr 50B 30  
1/4" (6.3 mm) (152.4 mm) Cr 50B 30

**YATO**  
YT-5541 8

GB Drawer insert / Socke se  
D Schubladeneinlage / Steckschlüsselsatz  
PL Wkład do szuflady / Zestaw kluczy nasadowych  
RUS Вклад к выдвижному ящику / Торцовые ключи  
CZ Vložka do zásuvky / Kľíče nástrčné  
H Fiókbetét / Dugókulcsok  
RO Adaos la sertar / Duză cheie  
F Module plastique pour servante avec set d'outillages  
I Tenone per l'armadio chiave a bussola  
E Accesorio de cajón / Llaves de cubo  
CN 套筒托盘组套

PLASTIC TRAY & COLOR LABEL



24  
PCS



1/2" (12.7 mm) 10 11 12 13 14 15 16  
17 18 19 20 21 22 23 24  
27 30 32 mm Cr 50B 30  
1/2" (12.7 mm) (127 mm) Cr 50B 30  
1/2" (12.7 mm) Cr 50B 30  
1/2" (12.7 mm) (255 mm) 72T Cr 6140  
1/2" (12.7 mm) (255 mm) Cr 50B 30  
1/2" (12.7 mm) 16 21 mm Cr 50B 30

**YATO**  
YT-5537 4

GB Drawer insert / Screwdriver bits  
D Schubladeneinlage / Endstücke für Schraubenzieher  
PL Wkład do szuflady / Końcówki śrubokrętowe  
RUS Вклад к выдвижному ящику / Насадки для отвёрток  
CZ Vložka do zásuvky / Šroubovací nástavce  
H Fiókbetét / Csavarhúzó bitek  
RO Adaos la sertar / Terminații pt. şurubelnițe  
F Module plastique pour servante avec set d'embouts  
I Tenone per l'armadio chiave punti di avvitamento  
E Accesorio de cajón / Puntas para desarmadores  
CN 旋具头托盘组套

PLASTIC TRAY & COLOR LABEL



40  
PCS



H4 H5 H6 H7 H8 H10 H12 ( 30 mm) H4 H5 H6 H7  
H8 H10 H12 ( 75 mm) S S2 M5 M6 M7 M10 M12  
( 30 mm) M5 M6 M7 M10 M12 ( 75 mm) S S2  
T20 T25 T30 T40 T45 T50 T55 ( 30 mm) T20 T25 T30 T40  
T45 T50 T55 ( 75 mm) S S2 1/2" (12.7 mm) 3/8" (9.5 mm)

**YATO**  
YT-5538 8

- GB Drawer inser / Socke se
- D Schubladeneinlage / Steckschlüsselsatz
- PL Wkład do szuflady / Zestaw kluczy nasadowych
- RUS Вклад к выдвижному ящику / Торцовые ключи
- CZ Vložka do zásuvky / Klíče nástrčné
- H Fiókbetét / Dugókulcsok
- RO Adaos la sertar / Duză cheie
- F Module plastique pour servante avec set d'outillages
- I Tenone per l'armadio chiave a bussola
- E Accesorio de cajón / Llaves de cubo
- CN 套筒托盘组套



14  
PCS

CrV  
50BV30



3/4" (19.0 mm) 19 21 22 24 27 28 30 32 34 36 41 46 50 55 mm



- GB Drawer insert / Deep sockets
- D Schubladeneinlage / Tiefe Steckschlüssel
- PL Wkład do szuflady / Klucze nasadowe długie
- RUS Вклад к выдвижному ящику / Торцовые глубокие ключи
- CZ Vložka do zásuvky / Klíče nástrčné hluboké
- H Fiókbetét / Mély dugókulcsok
- RO Adaos la sertar / Prize de curent adânci
- F Module plastique pour servante avec set de douilles
- I Tenone per l'armadio chiave a bussola lunghe
- E Accesorio de cajón / Llaves de cubo profundo
- CN 六角长套筒托盘组套



14  
PCS

CrV  
50BV30



1/2" (12.7 mm) 8 9 10 11 12 13 14 15 16 17  
18 19 20 21 mm ( 76 mm) Cr 50B 30



- GB Drawer inser / Too se
- D Schubladeneinlage / Sechskant-Steckschlüssel-Satz
- PL Wkład do szuflady / Zestaw narzędziowy
- RUS Вклад к выдвижному ящику / Набор инструмента
- CZ Vložka do zásuvky / Sada nástrčných klíčů a ráčny
- H Fiókbetét / Dugókulcs készlet racsnis hajtókarral
- RO Adaos la sertar / Rotrusa chei tubulare cu antrenor
- F Module plastique pour servante / Coffret d'outillage
- I Tenone per l'armadio / Set di utensili
- E Accesorio de cajón / Juego de herramientas
- CN 套筒扳手套套



31  
PCS

CrV

S2



1/2" (12.7 mm) 10 12 14 16 18 20 ( 38 mm) Cr 50B 30  
M5 M6 M7 M10 M12 ( 30 mm) S S2  
1/2" (12.7 mm) 10 mm Cr 6150  
2 2.5 3 4 5 6 7 8 10 12 mm Cr 6150  
T10 T15 T20 T25 T27 T30 T40 T45 T50 Cr 6150



- GB Drawer insert / Hammers and chisels
- D Schubladeneinlage / Hämmer und Meißel
- PL Wkład do szuflady / Młotki i przecinaki
- RUS Вклад к выдвижному ящику / Молотки и зубила
- CZ Vložka do zásuvky / Kladiva, dláta a sekáče
- H Fiókbetét / Kalapácsok és hidegvágók
- RO Adaos la sertar / Ciocane și dălți
- F Module plastique pour servante avec marteaux et burins
- I Tenone per l'armadio martelli e scalpelli
- E Accesorio de cajón / Martillos y cinceles
- CN 锤头凿子托盘组套



5  
PCS

CrV



300 ( 300 mm)  
40 mm ( 350 mm)  
10 8 142 mm  
12 10 152 mm 16 13 172 mm



16

- GB Drawer inser / Measuring tools
- D Schubladeneinlage / Messwerkzeuge
- PL Wkład do szuflady / Narzędzia miernicze
- RUS Вклад к выдвижному ящику / Измерительные приборы
- CZ Vložka do zásuvky / Měřeni
- H Fiókbetét / Mérészközök
- RO Adaos la sertar / Instrumente de măsură
- F Module plastique pour servante / Outils de mesurage
- I Tenone per l'armadio / Strumenti di misura
- E Accesorio de cajón / Instrumentos de medición
- CN 量具托盘组套



5  
PCS



300 mm 0-150 mm  
2 m  
3m 16 mm 0 02-1 00 mm



- GB Drawer insert / Steel file set
- D Schubladeneinlage / Werkstatt-feilen
- PL Wkład do szuflady / Pilniki do metalu
- RUS Вклад к выдвижному ящику / Набор напильников слесарных
- CZ Vložka do zásuvky / Zámečnické pilníky
- H Fiókbetét / Lakatos reszelő
- RO Adaos la sertar / Pile de lăcătuşerie
- F Module plastique pour servante / Fichier steel ensemble
- I Tenone per l'armadio / File di metallo
- E Accesorio de cajón / Juego de limas para metal
- CN 锉刀托盘组套



5  
PCS

T12  
STEEL



#2 200 mm  
#2 200 mm  
#2 200 mm  
#2 200 mm  
#2 200 mm





- GB Drawer insert / Hand riveter with rivets  
D Schubladeneinlage / Blindnietzange  
PL Wkład do szuflady / Nitownica ręczna z głowicą obrotową  
RUS Вклад к выдвижному ящику / Запечочник  
CZ Vložka do zásuvky / Ruční nýtovačka  
H Fiókbetét / Kézi popszegeshűző  
RO Adaos la sertar / Pclește pt. popnituri  
F Module plastique pour servante / Riveteuse a main  
I Tenone per l'armadio / Rivettatrice manuale girevole  
E Accesorio de cajón / Remachadora de mano  
CN 手动铆钉枪及铆钉托盘组套

PLASTIC TRAY & COLOR LABEL



6  
PCS

CrMo



24 32 40 48 mm  
96 32 96 40 127 40 96 48 127 48 mm

**YATO**  
YT-55466 8

- GB Drawer insert / Too se  
D Schubladeneinlage / Sechskant-Steckschlüssel-Satz  
PL Wkład do szuflady / Zestaw narzędziowy  
RUS Вклад к выдвижному ящику / Набор инструмента  
CZ Vložka do zásuvky / Sada nástrčných klíčů a ráčny  
H Fiókbetét / Dugókulcs készlet racsnis hajtókarral  
RO Adaos la sertar / Rotrusa chei tubulare cu antrenor  
F Module plastique pour servante / Coffret d'outillage  
I Tenone per l'armadio / Set di utensili  
E Accesorio de cajón / Juego de herramientas  
CN 套筒扳手组套

PLASTIC TRAY & COLOR LABEL



6  
PCS

CrMo

CrV



1"(25 mm) 330 mm  
250 mm

24 32 40 48 mm  
96 32 96 40 127 48 mm

**YATO**  
YT-55478 8

- GB Drawer insert / Automotive workshop tools  
D Schubladeneinlage / Kfz-werkzeuge  
PL Wkład do szuflady / Zestaw narzędzi warsztatowych  
RUS Вклад к выдвижному ящику / Автомобильные инструменты  
CZ Vložka do zásuvky / Auto nářadí  
H Fiókbetét / Autóipari szerszámok  
RO Adaos la sertar / Scule auto  
F Module plastique pour servante / Outils de réparation automobile  
I Tenone per l'armadio / Set attrezzi officina  
E Accesorio de cajón / Herramientas de automoción  
CN 轮胎修理工具托盘组套

PLASTIC TRAY & COLOR LABEL



5  
PCS

CrV



200 mm 135 mm  
300 400 500 mm

**YATO**  
YT-55477 4

- GB Drawer insert / Automotive workshop tools  
D Schubladeneinlage / Kfz-werkzeuge  
PL Wkład do szuflady / Zestaw narzędzi warsztatowych  
RUS Вклад к выдвижному ящику / Автомобильные инструменты  
CZ Vložka do zásuvky / Auto nářadí  
H Fiókbetét / Autóipari szerszámok  
RO Adaos la sertar / Scule auto  
F Module plastique pour servante / Outils de réparation automobile  
I Tenone per l'armadio / Set attrezzi officina  
E Accesorio de cajón / Herramientas de automoción  
CN 轮胎修理工具托盘组套

PLASTIC TRAY & COLOR LABEL



10  
PCS

CrV



1/2" (12.7 mm) 5/16" (7.9 mm)  
PH3 ( 35 mm) PH1 PH2 PH3 ( 75 mm)  
8 mm ( 35 mm) 8 mm ( 75 mm)  
12-38 mm 3" (75 mm) 82 mm

**YATO**  
YT-55476 4

- GB Drawer insert / Too se  
D Schubladeneinlage / Sechskant-Steckschlüssel-Satz  
PL Wkład do szuflady / Zestaw narzędziowy  
RUS Вклад к выдвижному ящику / Набор инструмента  
CZ Vložka do zásuvky / Sada nástrčných klíčů a ráčny  
H Fiókbetét / Dugókulcs készlet racsnis hajtókarral  
RO Adaos la sertar / Rotrusa chei tubulare cu antrenor  
F Module plastique pour servante / Coffret d'outillage  
I Tenone per l'armadio / Set di utensili  
E Accesorio de cajón / Juego de herramientas  
CN 套筒扳手组套

PLASTIC TRAY & COLOR LABEL

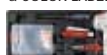

23  
PCS



140 mm 200 mm  
19 mm 20 mm 4 190 mm 250  
10 15 20 25 30 35 40 45 50 55  
60 65 70 75 80 85 90 95 100 mm

**YATO**  
YT-55471 8

- GB Drawer insert / Taps and die set  
D Schubladeneinlage / Gewindeschneidwerkzeug-satz  
PL Wkład do szuflady / Zestaw narzynek i gwintowników  
RUS Вклад к выдвижному ящику / Набор плашек и метчиков  
CZ Vložka do zásuvky / Souprava závitníků a kruhových závitových čelistí  
H Fiókbetét / Menetfűró és menetvágó készlet  
RO Adaos la sertar / Set de tarozi și filiere  
F Module plastique pour servante / Pince a riveter avec embouts  
I Tenone per l'armadio / Set di filiera a maschi  
E Accesorio de cajón / Juego de machos de roscar y cojinetes  
CN 丝锥板牙托盘组套

PLASTIC TRAY & COLOR LABEL



35  
PCS

HCS



3 M3 05 M4 07 M5 08 M6 10 M7 10 M8 125  
M10 15 M12 175 M3 05 M4 07 M5 08 M6 10 M7 10 M8 125  
M10 15 M12 175 05 175 mm 27G 28G  
M7-M9 M3-M12

**YATO**  
YT-55465 8

- |     |                          |    |                                |
|-----|--------------------------|----|--------------------------------|
| GB  | Drawer inser             | RO | Adaos la sertar                |
| D   | Schubladeneinlage        | F  | Module plastique pour servante |
| PL  | Wkład do szuflady        | I  | Tenone per l'armadio           |
| RUS | Вклад к выдвижному ящику | E  | Accesorio de cajón             |
| CZ  | Vložka do zásuvky        | CN | 吸塑盒                            |
| H   | Fiókbetét                |    |                                |



for / dla: YAT-5531

<b>YATO</b>	
YAT-55311	5/30



for / dla: YAT-5532

<b>YATO</b>	
YAT-55321	5/30



for / dla: YAT-5533

<b>YATO</b>	
YAT-55331	5/30

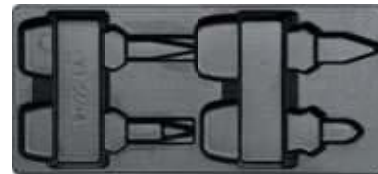

for / dla: YAT-5534

<b>YATO</b>	
YAT-55341	5/30

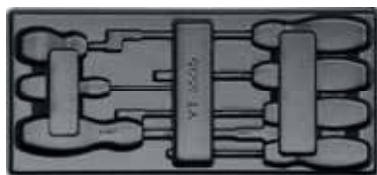

for / dla: YAT-5535

<b>YATO</b>	
YAT-55351	5/30

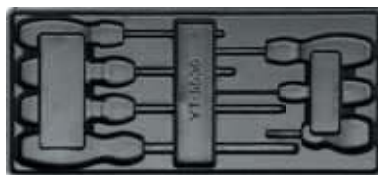

for / dla: YAT-5536

<b>YATO</b>	
YAT-55361	5/30



for / dla: YAT-5537

<b>YATO</b>	
YAT-55371	5/30

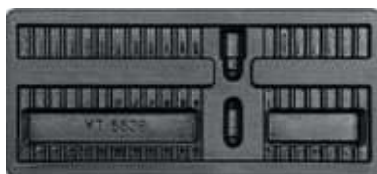

for / dla: YAT-5538

<b>YATO</b>	
YAT-55381	5/30



for / dla: YAT-5539

<b>YATO</b>	
YAT-55391	5/30



for / dla: YAT-5540

<b>YATO</b>	
YAT-55401	5/30

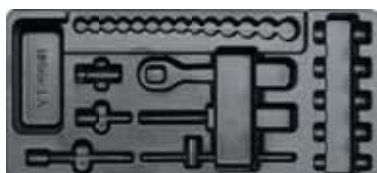

for / dla: YAT-5541

<b>YATO</b>	
YAT-55411	5/30

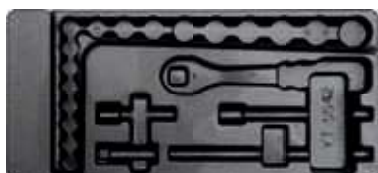

for / dla: YAT-5542

<b>YATO</b>	
YAT-55421	5/30



for / dla: YAT-55454

<b>YATO</b>	
YAT-55479	5/30

16

- |     |  |
|-----|--|
| GB  | legs for workbench on                      |
| D   | Beine für Werkbank, lange                  |
| PL  | Nogi do stołu warsztatowego, długie        |
| RUS | Ножки для верстака, длинные                |
| CZ  | Nohy k pracovnímu stolu, dlouhé            |
| H   | Labak munkapad, hosszú                     |
| RO  | Picioare pt. banc de lucru, lungi          |
| F   | Jambes pour table d'atelier                |
| I   | Gambe del tavolo piedi del banco da lavoro |
| E   | Patas para banco de trabajo, largas        |
| CN  | 工作台长桌腿                                     |



**2**  
PCS  
**140**  
cm

for / dla: YAT-08920

<b>YATO</b>	size / rozmiar (cm)	
YAT-08921	140	2

WHITE  
CARTON BOX  
& COLOR LABEL



- |     |   |
|-----|---|
| GB  | Holders for workshop box                                  |
| D   | Halterungen für die Montage eines erks a schrankes        |
| PL  | Uchwyty do montażu szafki warsz a owe                     |
| RUS | Крепеж для рабочего шкафа                                 |
| CZ  | Montážní držáky dílenské skříňky                          |
| H   | Műhelyszekrény tartó                                      |
| RO  | Suporturi pt. montarea dulapului de atelier               |
| F   | Porte-placard d'atelier                                   |
| I   | Staffa di montaggio per armadio portautensili             |
| E   | Elementos de fijación para instalación de cajón de taller |
| CN  | 工具柜安装挂板   |



**2**  
PCS  
**500x100**  
**x350 mm**

for / dla: YAT-08920, YAT-09151, YAT-09152

<b>YATO</b>	size / rozmiar (mm)	
YAT-08922	500 100 350	2

WHITE  
CARTON BOX  
& COLOR LABEL



GB Connection steel pipes set  
D Anschluss S ah rohre Gesez  
PL Rury montażowe  
RUS Стальная труба монтаж  
CZ Ose ov rubk  
H csövek  
RO Tevi din otel  
F Tuau en acier  
I Set di montaggio  
per tabella utensili  
E Tubos de acero  
CN 工具柜连接杆



POLYBAG

2  
PCS

48.5  
x 2.8 cm

for / dla:  
YT-09151  
YT-09152  
YT-09155  
+  
YT-0902  
YT-0903  
YT-0904



YATO	size / rozmiar (cm)	
YT-09071	48 5 2 8	20

GB Double project center backwall  
D Werkzeugwand  
PL Tablica narzędziowa  
RUS Доска инструмент  
CZ Držáky na nářadí  
H Szerszámtartó fal akasztókkal  
RO Suport perete scule  
F Mur d'outil  
I a be a u ensi i  
E Panel de herramientas  
CN 工具车双挂板

POLYBAG

2  
PCS

65.2 x 61  
x 5.5 cm



for / dla:  
YT-0902 YT-55290  
YT-0903 YT-55292  
YT-09031 YT-55293  
YT-0904 YT-5530

YATO	size / rozmiar (cm)	
YT-09072	65 2 61 5 5	2

GB Compartmented shelf  
and paper roll holder  
D erks a wa enab- a e  
mit Papierrollehalter  
PL Półka z uchwytem  
na papier  
RUS Полка с держателем  
для бумаги  
CZ Police s úchytem na papír  
H Kiegészítő polc és papírröli  
tartó funkcióval  
RO Compartiment pt. dulap  
si suport hartie  
F Support rouleau papier  
I Mensola portarotoli carta  
E Estante con sujetapapel  
CN 托架



for / dla: YT-0902, YT-0903, YT-0904, YT-0905

YATO	size / rozmiar (mm)	
YT-0907	305 305 145	4

GB Dust bin  
D bfa eimer  
PL Pojemnik na odpady  
RUS Мусорный ящик  
CZ Zásobník na odpad  
H Szemétkosár  
RO Lada de gunoi  
F Poubelle  
I Contenitore di rifiuti  
E Cubo de basura  
CN 废品箱



for / dla: YT-0902, YT-0903, YT-0904, YT-0905

YATO	size / rozmiar (mm)	
YT-0908	300 300 190	4

GB Separate board for drawer  
D Trennsteg für Werkstatt-  
Wagen-Schublade  
PL Przegroda do szafki  
RUS Перегородки для ящика  
CZ Pňhradka do police  
H Több rekeszes tálcá  
RO Sertar separat  
de masura mica  
F Coison iroir cour  
I Separatore per armadio  
E Separador  
para armario  
CN 抽屉分隔板



for / dla: YT-0902, YT-0903, YT-0904, YT-0905

YATO	size / rozmiar (mm)	
YT-0910	391 58 4	24
YT-0911	391 128 4	12



GB Too bo  
D erkezu kas en  
PL Skrzynka narzędziowa  
RUS Инструментальный ящик  
CZ Skříňka na nářadí  
H Szerszámos láda

RO Cutie de scule  
F Boîte à outils  
I Cassetta degli attrezzi  
E Caja de herramientas  
CN 工具箱

WHITE  
CARTON BOX  
& COLOR LABEL

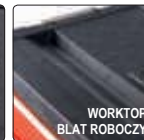

WORKTOP  
BLAT ROBOCZY

RUBBER CORNER  
GUMOWY NAROŻNIK



<b>YATO</b>	drawers / szuflady	
YT-09108	1	2

<b>YATO</b>	drawers / szuflady	
YT-09107	2	2

GB Too ro e  
D erkzeu kas en  
PL Wózek narzędziowy 3-częściowy  
RUS Тележка инструментальная  
CZ Vozík na nářadí  
H Szerszám kocsi  
RO Instrument cărucior  
F Servante d'atelier  
I Armadio per utensili  
E Herramienta a carro  
CN 工具箱



WHITE  
CARTON BOX  
& COLOR LABEL



WORKTOP  
BLAT ROBOCZY

MODULES  
PROTECTION

ZABEZPIECZENIE  
MODUŁÓW

RUBBER CORNER  
GUMOWY NAROŻNIK



<b>YATO</b>		
YT-09102		1

<b>YATO</b>		
YT-09101		1

GB Can iever oo bo  
D erkzeu koffer  
PL Skrzynka narzędziowa  
RUS Инструментальный ящик  
CZ Nástrojová skříňka  
H Szerszámosláda  
RO Cutie pt. scule  
F Boîte à outils  
I Cassetta degli attrezzi  
E Caja de herramientas  
CN 工具箱

WHITE  
CARTON  
BOX  
& COLOR  
LABEL



YATO	size / rozmiar (mm)	
YT-0882	360 150 115	4

YATO	size / rozmiar (mm)	
YT-0883	428 180 180	1



YATO	size / rozmiar (mm)	
YT-0884	460 200 180	1

YATO	size / rozmiar (mm)	
YT-0885	460 200 225	1

YATO	size / rozmiar (mm)	
YT-0886	510 220 240	1

GB Too bo wih oos  
D erkzeu koffer  
PL Skrzynka z narzędziami  
RUS Инструментальный ящик  
CZ Nástrojová skříňka  
H Szerszámosláda  
RO Cutie pt. scule  
F Boîte d'outils  
I Cassetta degli attrezzi  
E Caja de herramientas  
CN 工具箱



62 PCS	1/2" 12.5mm	CrV 50BV30	CrV 6150	CrV 6140
72T	AS-DRIVE	⊖	⊕	

- 1/2" (12.7 mm) 10 11 12 13 14 15 16 17 18 19 20 21 22 23 24 mm ( 38 mm) 27 30 32 mm ( 42 mm) Cr 50B 30
- 1/2" (12.7 mm) (76 127 254 mm) Cr 50B 30
- 1/2" (12.7 mm) Cr 50B 30
- 1/2" (12.7 mm) 21 mm Cr 50B 30
- 1/2" (12.7 mm) (255 mm) Cr 50B 30
- 1/2" (12.7 mm) 72T Cr 6140
- 1/2" (12.7 mm) (450 mm) Cr 50B 30
- 6 7 8 9 10 11 12 13 14 15 16 17 18 19 20 21 22 24 mm Cr
- 6 100 6 150 8 200 mm Cr 6150
- PH2 100 PH3 150 PH3 200 mm Cr 6150
- 180 mm Cr 160 mm Cr 160 mm Cr
- 15 2 25 3 4 5 6 8 10 mm Cr 6150

WHITE  
CARTON  
BOX  
& COLOR  
LABEL



YATO	size / rozmiar (mm)	
YT-3895	475 230 365	1

GB Too box  
 D Werkzeugkoffer  
 PL Skrzynka z narzędziami  
 RUS Инструментальный ящик  
 CZ Nástrojová skříňka  
 H Szerszámoszláda  
 RO Cutie pt. scule  
 F Boîte d'outils  
 I Cassetta degli attrezzi  
 E Caja de herramientas  
 CN 工具组套



64 PCS	1/2" 12.5mm	CrV 50BV30	CrV 6150	CrV 6140
CrMo	72T	AS-DRIVE	⊖	⊕

- 1/2" (12.7 mm) 10 11 12 13 14 15 16 17  
18 19 20 21 22 23 24 mm ( 38 mm)  
27 30 32 mm ( 42 mm) Cr 50B 30
- 1/2" (12.7 mm) (76 127 254 mm) Cr 50B 30
- 1/2" (12.7 mm) Cr 50B 30
- 1/2" (12.7 mm) 21 mm Cr 50B 30
- 1/2" (12.7 mm) (255 mm) Cr 50B 30
- 1/2" (12.7 mm) (255 mm) 72T Cr 6140
- 1/2" (12.7 mm) (457 mm) Cr 50B 30
- 6 7 8 9 10 11 12 13 14 15 16 17 18 19 20 21 22 24 mm Cr
- 5 100 6 150 8 200 mm S2
- PH1 100 PH2 150 PH3 200 mm S2
- 180 mm Cr 160 mm Cr 160 mm Cr
- 250 mm Cr 180 mm CrMo
- 1.5 2 2.5 3 4 5 6 8 10 mm Cr 6150



<b>YATO</b>	size / rozmiar (mm)	
YT-38950	495 200 290	1



GB Too box  
 D Werkzeugkoffer  
 PL Skrzynka z narzędziami  
 RUS Инструментальный ящик  
 CZ Nástrojová skříňka  
 H Szerszámoszláda  
 RO Cutie pt. scule  
 F Boîte d'outils  
 I Cassetta degli attrezzi  
 E Caja de herramientas  
 CN 工具组套

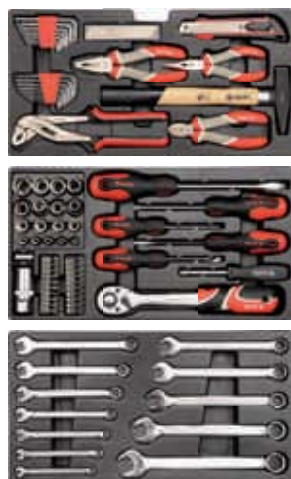

16

- 1/2" (12.7 mm) 10 11 12 13 14 15 17 19 mm ( 38 mm)  
1/4" (6.3 mm) 5 6 7 8 9 10 11 12 13 mm  
( 25 mm) Cr 50B 30
- 1/2" (12.7 mm) 21 mm Cr 50B 30
- 1/2" (12.7 mm) (255 mm) 72T Cr 6140
- 1/4" (6.3 mm) (150 mm) Cr 50B 30
- 1/4" (6.3 mm) 1/4" (6.3 mm) Cr 50B 30
- 1/4" (6.3 mm) 3 (2) 4 (2) 5 (2) 5.5 (2) 6 (2) mm ( 25 mm) S S2
- 1/4" (6.3 mm) PH0 PH1 (2) PH2 (2) PH3 ( 25 mm) S S2
- 1/4" (6.3 mm) PZ0 PZ1 (2) PZ2 ( 25 mm) S S2
- 6 7 8 9 10 11 12 13 14 15 17 19 mm Cr
- 5 75 mm 6 100 mm 8 150 mm PH1 75 mm PH2 100 mm S2
- 180 mm Cr 160 mm Cr 160 mm Cr
- 250 mm 300 18 mm; SK2; 18x0.5 mm; SK2;
- 1.5 2 2.5 3 4 5 5.5 6 mm T10 T15 T20 T25 T27 T30 T40 Cr

80 PCS	1/2" 12.5mm	1/4" 6.3mm	CrV 50BV30	CrV 6140
S2	72T	AS-DRIVE	⊖	⊕



<b>YATO</b>	size / rozmiar (mm)	
YT-38951	460 220 245	1

GB Oil filter wrench  
D Ölfilterschlüssel  
PL Klucz do filtra oleju  
RUS Ключ к масляному фильтру  
CZ Klíč na olejový filtr  
H Olajszűrő kulcs  
RO Cheie pt. filtru de ulei  
F Clé au filtre d'huile  
I Chiave per filtro olio  
E Llave para el filtro de aceite  
CN 滤清器扳手



GB Be oi wrench  
D Ölfilterschlüssel mit Riemen  
PL Klucz taśmowy do filtrów oleju  
RUS Ключ тросовый для масляных фильтров  
CZ Klíč na olejové filtry  
H Olajszűrő kulcs  
RO Cheie filtru cu banda  
F Clé au filtre d'huile  
I Chiave a nastro per filtro olio  
E Llave de cinta para filtros de aceite  
CN 皮带钳扳手

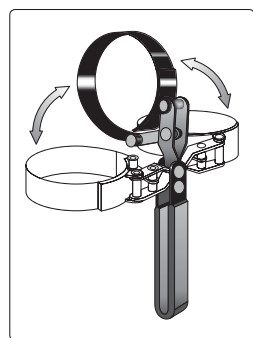

SLIDING CARD

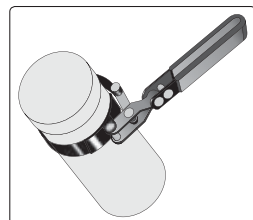

YATO	Ø (mm)	Box
YT-0820	60-73	12/48
YT-0821	73-85	12/48
YT-0822	85-95	12/48
YT-0823	95-111	12/48

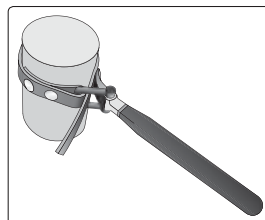

BLISTER CARD



YATO	Ø (mm)	Box
YT-0824	80-160	6/60
YT-0825	100-200	5/20

GB Oil filter wrench  
D Ölfilterschlüssel  
PL Klucz do filtra oleju  
RUS Съёмник масляных фильтров  
CZ Klíč na filtr oleju řetezový  
H Olajszűrő kulcs, láncos  
RO Cheie filtru ulei cu lanț  
F Clé au filtre d'huile  
I Chiave per filtro olio  
E Llave do filtro de cadenta  
CN 滤清器扳手



COLOR BOX



63-120 mm 2.5-4"	3/8" 10.0 mm	1/2" 12.5 mm
HRC 40-50	CrV	

YATO	Box
YT-0826	12/36

GB Cap type oil filter wrench set  
D Steckschlüsselsatz für den Ölfilter  
PL Zestaw kluczy nasadowych do filtra oleju  
RUS Набор торцовых ключей к масляному фильтру  
CZ Sada miskovitých klíčů na olejové filtry  
H Dugókulcs készlet olajszűrőhöz  
RO Set de chei tubulare pt. filtru de ulei  
F Set d'embouts aux filtres d'huile  
I Set di chiavi filtro olio  
E Juego de llaves de tubo para el filtro de aceite  
CN 碗型滤清器扳手组套



15  
PCS

FIBRE  
REINFORCED  
POLYMER

3/8"  
10 mm

16

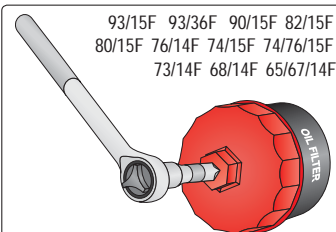

93/15F 93/36F 90/15F 82/15F  
80/15F 76/14F 74/15F 74/76/15F  
73/14F 68/14F 65/67/14F

BMC & COLOR SLEEVE



YATO	Ø	Box
YT-0595	3/8" (9.5 mm)	5

GB Cap type oil filter wrench set  
 D Steckschlüsselsatz für den Ölfilter  
 PL Zestaw kluczy nasadowych do filtra oleju  
 RUS Набор торцовых ключей к масляному фильтру  
 CZ Sada miskovitých klíčů na olejové filtry  
 H Dugókulcs készlet olajsűrőhöz

RO Set de chei tubulare pt. filtru de ulei  
 F Set d'embouts aux filtres d'huile  
 I Set di chiavi filtro olio  
 E Juego de llaves de tubo para el filtro de aceite  
 CN 碗型滤清器扳手组套

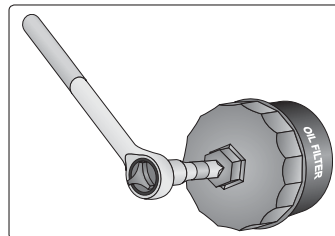

**13**  
PCS

**3/8"**  
10mm

**1/2"**  
12.5mm

**65-120**  
mm



BMC  
& COLOR  
SLEEVE



YATO	number number	size rozmiar	layers warstwy	grooves bruzdy	radius a es	car models modele samochodow
YT-0594	66/6	S 66	1	6		Fiat Punto 1.2, Renault Clio 1.2, Rapid, Twingo
	76/8	S 76	1	8		Fiat anciana
	76/12	S 76	1		12	Fiat, Mercedes, Renault
	86/16	S 86	1		16	o vo
	86/18	S 86	1		18	VW Golf, Audi A6 TDI, Peugeot, Citroen
	92/10	S 92	1		10	Fia
	93/45	S 93	1	45		VW, Audi TDI
	96/18	S 96	1	18		Audi A4, A6 TDI, VQ Passat TDI, Renault Laguna
	106/15	S 106	1		15	Fia Duca o
	108/15	S 108	1		15	o vo
	108/18	S 108	1	18		Renault Espace, Laguna, Safrane, Traffic

GB Cap type oil filter wrench set  
 D Steckschlüsselsatz für den Ölfilter  
 PL Zestaw kluczy nasadowych do filtra oleju  
 RUS Набор торцовых ключей к масляному фильтру  
 CZ Sada miskovitých klíčů na olejové filtry  
 H Dugókulcs készlet olajsűrőhöz

RO Set de chei tubulare pt. filtru de ulei  
 F Set d'embouts aux filtres d'huile  
 I Set di chiavi filtro olio  
 E Juego de llaves de tubo para el filtro de aceite  
 CN 碗型滤清器扳手组套

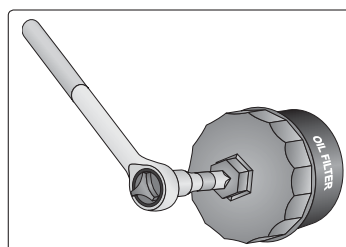

**30**  
PCS

**3/8"**  
10mm

BMC  
& COLOR  
SLEEVE



YATO	number number	size rozmiar	layers warstwy	grooves bruzdy	radius a es	car models modele samochodow
YT-0596	66/6	S 66	1	6		Fiat Punto 1.2, Renault Clio 1.2, Rapid, Twingo
	65/14	S 65	1		14	Daihatsu Toyota Nissan Fiat
	65/67	S 65-67	1		14	Daihatsu Toyota
	68/14	S 68	1		14	Mazda, Ford, Subaru
	73/14	S 73	1		14	Toyota Lexus
	74/15	S 74	1		15	Audi, Rover, Chrysler
	74/76	S 74-76	2		15	Ford, Opel, VW, Audi, Mercedes
	75/77	S 75-77	2		15	VW, Audi, Isuzu, Mercedes
	76/12	S 76	1		12	Fiat, Mercedes, Renault
	76/14	S 76	1		14	VW, Porsche, Mercedes, BMW, Audi, Opel
	76/30	S 76	1	30		Ford
	76/8	S 76	1	8		Fiat anciana
	78/15	S 78	1		15	Nissan, Ford, Toyota
	80/15	S 80	1		15	Nissan, Honda, Opel, Mazda
	80/82	S 80-82	2		15	Subaru, Toyota, Honda, Nissan
	86/16	S 86	1		16	o vo
	86/18	S 86	1		18	VW Golf, Audi A6 TDI, Peugeot, Citroen
	90/15	S 90	1		15	Honda, Mitsubishi, Isuzu
	92/10	S 92	1		10	Fia
	93/15	S 93	1		15	Mazda, Volvo, Mitsubishi, Nissan, Honda
	93/36	S 93	1	36		Ford
	93/45	S 93	1	45		VW, Audi TDI
	95/15	S 95	1	15		Toyota, Alfa Romeo, Ford
	96/18	S 96	1	18		Audi A4, A6 TDI, VQ Passat TDI, Renault Laguna
	100/15	S 100	1		15	Subaru Mitsubishi
	106/15	S 106	1		15	Fiat Duca o
	108/15	S 108	1		15	o vo
	108/18	S 108	1	18		Renault Espace, Laguna, Safrane, Traffic



- GB Oil filter sockets
- D Aufsätze für die Ölfilter
- PL Zestaw nasadek do filtrów oleju
- RUS Набор насадок к масляным фильтрам
- CZ Sada nástavců na olejové filtry
- H Olajszűrő leszedő készlet
- RO Set de cartușe pt. filtre de ulei
- F Set d'embouts aux filtres d'huile
- I Set di chiavi filtro olio
- E Juego de tapones para los filtros de aceite
- CN 滤油器套筒组套



4 PCS	3/8" 10mm	27 32 36 38 mm
CrV		AS-DRIVE
BMC & COLOR SLEEVE		

<b>YATO</b>		
YT-0598	3/8" (9.5 mm)	20

- GB Oil drain plug set
- D ab asschrauben Schlüsselsatz
- PL Komplet kluczy do korków oleju
- RUS Комплект ключей для сливной пробки
- CZ Klíče nástrčné na zátky olejových van motorů
- H Olajleeresztő kulcs készlet
- RO Set bituri pt. bujon ulei
- F Ensemble de clés de bouchon de vidange d'huile
- I Set di chiavi a bussola
- E Juego de llaves para tapones de aceite
- CN 排油塞旋具组套



18 PCS	3/8" 10mm	7 8 10 11 12 13 14 mm
		8 9 10 12 14 17 mm
		CrV
8, 10 mm	10 mm	
5/16" 3/8"		

BMC  
& COLOR  
SLEEVE



<b>YATO</b>		
YT-0599	3/8" (9.5 mm)	10

- 7 8 10 11 12 13 14 mm   8 9 10 12 14 17 mm
- 5/16" (8 mm) 3/8" (10 mm)   10 mm   10 mm 160 mm

- GB Oil drain plug set
- D Ölblessschrauben Schlüsselsatz
- PL Komplet kluczy do korków oleju
- RUS Комплект ключей для сливной пробки
- CZ Klíče nástrčné na zátky olejových van motorů
- H Olajleeresztő kulcskészlet
- RO Set bituri pt. bujon ulei
- F Set de clés à vindage d'huile
- I Set di chiavi per tappi olio
- E Juego de llaves para tapones de aceite
- CN 排油塞旋具组套



12 PCS	3/8" 10mm	(mm) 8 11 13
		(mm) 8 9 10 12 14 17

SLIDING  
CARD



<b>YATO</b>		
YT-0600		10/20

- GB Oil pan thread repair set
- D Reparatursatz für Verschlussstopfen von Ölwanne
- PL Zestaw naprawy korków do miski olejowej
- RUS Набор для ремонта масляных пробок
- CZ Souprava na opravu vuproustěcích šroubů olejových van
- H Olajteknő-csavar javítókészlet
- RO Set pt. reparare dopuri baie de ulei
- F Kit réparation de bouchons de carter d'huile
- I Set per riparazione dei tappi della coppa del olio
- E Juego de reparación para los tapones del cárter de aceite
- CN 螺纹修复组套



64 PCS	CrMo
-----------	------

16

- |       |        |       |       |        |       |
|-------|--------|-------|-------|--------|-------|
| M13   | M13    | 13 mm | M17   | M17    | 17 mm |
| 5 pcs | 10 pcs |       | 5 pcs | 10 pcs |       |
| M15   | M15    | 15 mm | M20   | M20    | 20 mm |
| 5 pcs | 10 pcs |       | 5 pcs | 10 pcs |       |

BMC  
& COLOR  
SLEEVE



<b>YATO</b>		
YT-1757		10

GB Lever action grease gun with rigid spout  
 D Handhebel-Fettpresse  
 PL Smarownica ręczna z kołcówką sztywną  
 RUS Шприц для масляной смазки с твердым наконечником и гибким шлангом

CZ Páková maznice s pevnou koncovkou  
 H Karos zsírzó  
 RO Masina de gresat cu furturn rigid  
 F Pistolet de graissage manuel

I Lubrificatore manuale  
 E Pistola de engrase  
 CN 手动黄油枪

COLOR BOX



P max.  
70 MPa

P  
31 MPa

AI



500 cm<sup>3</sup>

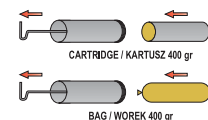

<b>YATO</b>	
YT-0700	20



120 cm<sup>3</sup>

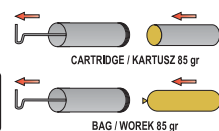

<b>YATO</b>	
YT-0701	30



400 cm<sup>3</sup>

<b>YATO</b>	
YT-0705	20

GB Grease un  
 D Handhebel-Fettpresse  
 PL Smarownica ręczna  
 RUS Шприц для масляной смазки  
 CZ Páková maznice

H Karos zsírzó  
 RO Masina de gresat cu furturn rigid  
 F Pistolet de graissage manuel

I Lubrificatore manuale  
 E Pistola de engrase  
 CN 大容量黄油枪

COLOR BOX



P (MPa)  
27-41

AI

600 cm<sup>3</sup>

<b>YATO</b>	
YT-07042	6/12

800 cm<sup>3</sup>

<b>YATO</b>	
YT-07043	4/8

GB Two-way operation grease gun  
D Handhebel-Fettpresse  
PL Smarownica ręczna, wzmacniona  
RUS Шприц для масляной смазки  
CZ Páková maznice  
H Karos zsírzó

RO Masina de gresat cu furtun rigid  
F Pistolet de graissage manuel  
I Lubrificatore manuale  
E Pistola de engrase  
CN 大容量黄油枪

COLOR BOX



500 cm<sup>3</sup> P<sub>max.</sub> 70 MPa AI P 42 MPa

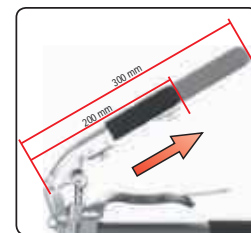

**YATO**  
YT-0704 12

HIGH PRESSURE  
69 MPa  
LOW VOLUME  
14 g / 40 STROKE

WYSOKIE CIŚNIENIE  
69 MPa  
NISKA WYDAJNOŚĆ  
14 g / 40 CYKLI

LOW PRESSURE  
6.9 MPa  
HIGH VOLUME  
100 g / 40 STROKE

NISKIE CIŚNIENIE  
6.9 MPa  
WYSOKA WYDAJNOŚĆ  
100 g / 40 CYKLI

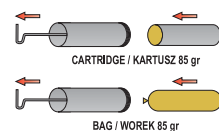

**YATO**  
YT-07041 10

GB Air release gun  
D Druckluft-Fettpresse  
PL Smarownica pneumatyczna  
RUS Шприц для нагнетания  
густой смазки пневматический  
CZ Mazací lis pneumatický  
H Pneumatikus zsírzó  
RO Pistol pt. gresat pneumatic  
F Pistolet de graissage pneumatique  
I Pneumatica per ingrassaggio  
E Pistola engrasadora neumática  
CN 气动黄油枪

400 cm<sup>3</sup> 28 l/min 1/4" 6.3mm

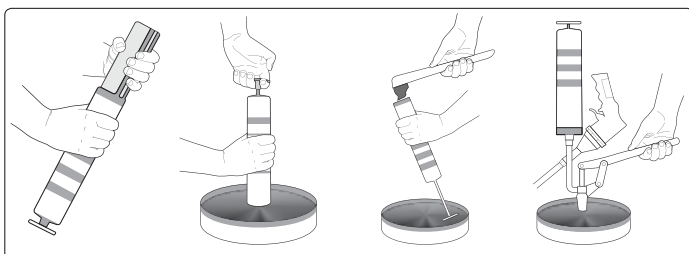

COLOR BOX



**YATO**  
YT-07055 10

- |                               |  |                                  |
|-------------------------------|--|----------------------------------|
| GB Oil transfer pump          | H Olajpumpa                              | E Bomba manuala de trasvase dual |
| D Öl-Umfüllpumpe              | RO Pompa de ulei de mana                 | CN 输油泵                           |
| PL Pompa transferowa do oleju | F Pompe pour huile                       |                                  |
| RUS Шприц для перекачки масел | I Lubrificatore manuale per travaso olio |                                  |
| CZ Ruční olejová pumpa        |  |                                  |

COLOR BOX



500 cm<sup>3</sup>

P max. 70 MPa

P 31 MPa



**YATO**

YT-0707



20

- |  |  |
|--|--|
| GB Oil drainer                               | H Kézi olajszivattyú                         |
| D Öl-Absaugpumpe                             | RO Pompa de ulei                             |
| PL Odsysarka ręczna do oleju                 | F Seringue à huile                           |
| RUS Ручной шприц для откачки масла           | I Lubrificatore manuale per aspirazione olio |
| CZ Ruční odsávačka oleje                     | E Bomba manual de trasvase                   |
| H Kézi olajszivattyú                         | CN 输油泵                                       |
| RO Pompa de ulei                             |  |
| F Seringue à huile                           |  |
| I Lubrificatore manuale per aspirazione olio |  |
| E Bomba manual de trasvase                   |  |
| CN 输油泵                                       |  |

COLOR BOX



500 cm<sup>3</sup>

P max. 70 MPa

P 31 MPa



**YATO**

YT-0708



20

- |                       |                                |                            |
|-----------------------|--------------------------------|----------------------------|
| GB Grease pump        | RO Grăsimă manuală pompa       | E Grasa manual de la bomba |
| D Manuelle fettpumpen | F Pistolet de graissage manuel | CN 黄油泵                     |
| PL Smarownica ręczna  | I Pompa manuali per grasso     |                            |
| RUS Шприц для смазки  | E Grasa manual de la bomba     |                            |
| CZ Maznice ruční      | CN 黄油泵                         |                            |
| H Kézi zsírzó pumpa   |                                |                            |

GREY CARTON BOX & COLOR LABEL



13.8 MPa (max)

1.5m HOSE WÄZ



4kg



8kg

<b>YATO</b>	capacity / wydajność (k )	
YT-07061	4	1

<b>YATO</b>	capacity / wydajność (k )	
YT-07063	8	1

- |   |   |
|---|---|
| GB Flexible hose for grease gun         | H Tömlő a zsírzóhoz                     |
| D Schlauch für Fettpresse               | RO Furtun flexibil pt. pistol de grasat |
| PL Wąż do towotnicy                     | F Tuyau pour pistolet de graissage      |
| RUS Шприц для перекачки масел           | I Tubo flessibile per pompe grasso      |
| CZ Hadička na maznice na šmír           | E Manguera para engrasador              |
| H Tömlő a zsírzóhoz                     | CN 手用黄油枪软管                              |
| RO Furtun flexibil pt. pistol de grasat |   |
| F Tuyau pour pistolet de graissage      |   |
| I Tubo flessibile per pompe grasso      |   |
| E Manguera para engrasador              |   |
| CN 手用黄油枪软管                              |   |

SLIDING CARD



ø3.2mm

<b>YATO</b>	L (mm)	
YT-0709	300	12/144
YT-0710	500	12/144

- GB Oiler with a flexible applicator  
D Ölkanne mit elastischem Applikator  
PL Oliwiarka z elastycznym aplikatorem  
RUS Масленка с гибким аппликатором  
CZ Olejníčka s ohebným aplikátorem  
H Hajlékony csövű olajozó  
RO Gresor cu aplicator flexibil  
F Burette à huile  
I Lubrificante con canna flessibile  
E Aceitera con aplicador flexible  
CN 油壶



IMPACT  
RESISTANT  
ODPORNE  
NA UDERZENIA



<b>YATO</b>	cm <sup>3</sup>	
YT-0690	220	10/120
YT-0691	270	10/120

<b>YATO</b>	cm <sup>3</sup>	
YT-0690	220	10/120
YT-0691	270	10/120



IMPACT  
RESISTANT  
ODPORNE  
NA UDERZENIA



<b>YATO</b>	cm <sup>3</sup>	
YT-06913	300	10/120
YT-06914	500	10/80

<b>YATO</b>	cm <sup>3</sup>	
YT-06913	300	10/120

- GB Oil pump  
D Öl-Umfüllpumpe  
PL Pompa tłokowa do oleju  
RUS Шприц ручной заливной  
CZ Ruční olejová pumpa  
H Olajpumpa  
RO Pompa de ulei de mana  
F Pompe pour huile  
I Pompa manuale  
ravaso fus i o io  
E Bomba  
manua  
para  
acei e  
CN 手摇泵

**16-18**  
l/min

**▽h**  
45-90  
cm

**55**  
min<sup>-1</sup>  
(max)

**0.3 l**  
CYCLE  
CYKL

**FOR OIL**  
DO  
OLEJU

**Al**



COLOR BOX



<b>YATO</b>	
YT-0712	10

- GB Aluminium rotary oil pump  
D Aluminium-Kurbelpumpe  
PL Aluminiowa pompa do oleju  
RUS Алюминиевый ручной  
бочковой насос  
CZ Hliník rotační čerpadlo  
H Alumínium rotációs szivattyú  
RO Aluminiu pompă rotativă  
F Pompe manuelle  
pour huile  
I Pompa a mano  
per olio  
E uminio bomba  
ro ar  
CN 铝合金手摇油泵

**21**  
l/min

**▽h**  
500 cm

**▽h**  
300 cm

**3xPIPE**  
3xRURA

**FOR OIL**  
DO  
OLEJU

**Al**



COLOR BOX



<b>YATO</b>	
YT-07115	10

- GB High value rotary barrel pump  
D Kurbelpumpe für Benzinfässer  
PL Wysokowydajna pompa  
rotacyjna do paliwa  
RUS Насос топливный ротационный  
CZ Čerpadlo palivové rotační  
H Kézi pumpa hordóhoz (forgatható)  
RO Pompa rotativa pt. combustibil  
F Pompe rotative à combustible  
I Pompa rotativa travaso gasolio  
E Bomba de combustible rotatoria  
CN 手摇泵

FOR FUEL, DIESEL, OIL  
DO PALIW I OLEJU

**1.0 l**  
CYCLE  
CYKL

**100**  
l/min

**ANTISTATIC HOSE**  
**2.4 m**  
(WZ ANTYSTATYCZNY)

**BRASS FILTER**  
**180 µm**  
MOSIĘZNY FILTR

**▽h**  
**100 cm**

**Al**



WHITE  
CARTON BOX  
& COLOR LABEL



<b>YATO</b>	
YT-0715	4

GB Two arms jaw puller F rac eur  
 D bzieher-2-armi I s ra ore  
 PL Ściągacz dwuramienny E rac or  
 RUS Съёмник для подшипников CN 两爪拉马  
 CZ Stahovák  
 H Csapaágylehúzó  
 RO rac or ru men i



CrV

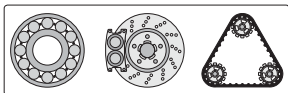

10 mm 4" 100 mm

10 mm 3" 75 mm

YATO	size / rozmiar	ma	Ø (mm)	max. force / max. sila nacisku ( )	
YT-2514	4" / 100 mm	60	60	12	6/60

YATO	size / rozmiar	ma	Ø (mm)	max. force / max. sila nacisku ( )	
YT-2515	3" / 75 mm	75	75	11	6/60



12 mm 4" 100 mm

17 mm 6" 150 mm



22 mm 8" 200 mm



YATO	size / rozmiar	ma	Ø (mm)	max. force / max. sila nacisku ( )	
YT-2516	4" / 100 mm	100	100	14	12/48

YATO	size / rozmiar	ma	Ø (mm)	max. force / max. sila nacisku ( )	
YT-2517	6" / 150 mm	120	120	6	10/20

YATO	size / rozmiar	ma	Ø (mm)	max. force / max. sila nacisku ( )	
YT-2518	8" / 200 mm	180	180	9	6

GB Three arms jaw puller F rac eur  
 D bzieher-3-armi I s ra ore  
 PL Ściągacz trójramienny E Extractor detres patas  
 RUS Съёмник для подшипников CN 三爪拉马  
 CZ Stahovák třiramenný  
 H Csapaágylehúzó  
 RO rac or ru men i cu rei bra e



CrV

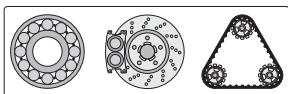

10 mm 3" 75 mm

12 mm 4" 100 mm

YATO	size / rozmiar	ma	Ø (mm)	max. force / max. sila nacisku ( )	
YT-2519	3" / 75 mm	80	80	15	6/60

YATO	size / rozmiar	ma	Ø (mm)	max. force / max. sila nacisku ( )	
YT-2520	4" / 100 mm	100	100	25	6/36



17 mm 6" 150 mm

22 mm 8" 200 mm



22 mm 12" 300 mm



YATO	size / rozmiar	ma	Ø (mm)	max. force / max. sila nacisku ( )	
YT-2521	6" / 150 mm	130	130	5	12

YATO	size / rozmiar	ma	Ø (mm)	max. force / max. sila nacisku ( )	
YT-2522	8" / 200 mm	180	180	9	4

YATO	size / rozmiar	ma	Ø (mm)	max. force / max. sila nacisku ( )	
YT-2523	12" / 300 mm	180	180	11	2

GB Three arms jaw puller F rac eur  
 D bzieher-3-armi I s ra ore  
 PL Ściągacz trójramienny E Extractor detres patas  
 RUS Съёмник для подшипников CN 三爪拉马  
 CZ Stahovák třiramenný  
 H Csapaágylehúzó  
 RO rac or ru men i cu rei bra e



CrV

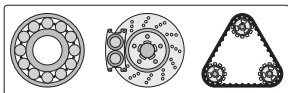

14 mm 3" 75 mm

YATO	size / rozmiar	Ø (mm)	
YT-2511	3" / 75 mm	50-150	20

15 mm 4" 100 mm

YATO	size / rozmiar	Ø (mm)	
YT-2512	4" / 100 mm	60-200	20

19 mm 6" 150 mm

YATO	size / rozmiar	Ø (mm)	
YT-2513	6" / 150 mm	80-300	10

- GB Universal puller set  
D Abziehvorrichtung für Lager  
PL Ściągacz do łożysk w miejscach trudnodostępnych  
RUS Съёмник подшипников в труднодоступных местах  
CZ Sada na stahování ložisek na obližně dostupných místech  
H Csapágyelhúzó nehezen hozzáférhető helyekhez  
RO Trăgător pt. rulmenți în locuri greu accesibile  
F rac eur au rou emen s  
I Set di estrattori universali  
E Extractor de rodamientos en lugares de difícil acceso  
CN 多功能拉拔器

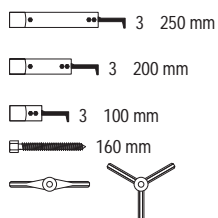

12  
PCS  
DROP  
FORGED  
KUTE

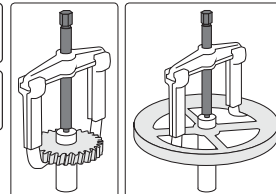

BMC  
& COLOR  
SLEEVE



<b>YATO</b>		
YT-25105		2

- GB Pilot bearing puller  
D Abzieher für Innenlager  
PL Ściągacz do łożysk wewnętrznych  
RUS Съёмник внутренних подшипников  
CZ Stahovák na ložiska vnitřní  
H Csapágyelhúzó, belső  
RO Clește interior pt. extras rulmenți  
F rac eur in rieur au rou emen s  
I s ra ore cuscin e i  
E Extractor de cojinetes interior  
CN 轴承拉马



12-38  
mm  
CrV  
6150



<b>YATO</b>	∅ (mm)	
YT-2510	12-38	20

- GB Universal wheel hub puller  
D Scheiben- und Trommelbremsen abzieher  
PL Ściągacz uniwersalny do tarcz i bębnow  
RUS Универсальный съёмник ступицы и полуоси  
CZ Stahovák na brzdové bubny  
H Univerzális féktárcsa és fékdob lehúzó

- RO Trusa universa a pt. transmisie cardanica  
F rac eur universe pour les disques et les tambours  
I s ra ore a vi e universa e  
E rac ur universa de discos y tambores  
CN 万用轮毂拉马

CrV  
90-140 mm  
130-180 mm

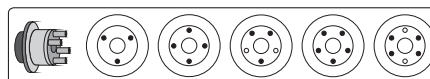

METAL CASE & COLOR BOX

<b>YATO</b>	L (mm)	
YT-0602	200	6

- GB Separator and hydraulic cylinder turnbuckle  
D Separator und Abziehvorrichtung mit Hydraulikservomotor  
PL Separator i ściągacz z silownikiem hydraulicznym  
RUS Сепаратор и съёмник с сервомотором  
CZ Oddělovač a stahovák s hydraulickým válcem  
H Csapágyelhúzó és körmös csapágyelhúzó hidraulikus kézpumpával  
RO Separator și ancoră cu servomotor hidraulic  
F Séparateur avec actionneur hydraulique  
I Separatore frizione cilindro idraulico  
E Separador y tensor de tornillo con cilindro hidráulico  
CN 液压分离器组合

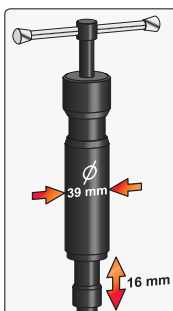

75-105 mm  
80-160 mm

50  
kN  
HYDRAULIC  
CYLINDER  
SIŁOWNIK  
HYDRAULICZNY

HRC  
38-45  
DROP  
FORGED  
KUTE

CrV



<b>YATO</b>	F (kN)	
YT-0609	50	2

- GB Twin leg puller with jaw hook
- D Doppel Abzieher mit Haken
- PL Ściągacz uniwersalny dwuramienny
- RUS Съёмник универсальный
- CZ Stahovák dvouramenný univerzální
- H Csapágyelhúzó készlet
- RO Carlig cu falci pt. extras cu picor dublu
- F Extracteur universel à deux bras
- I Estrattore universale a due bracci
- E Extractor de cuatro patas
- CN 单边两爪拉马

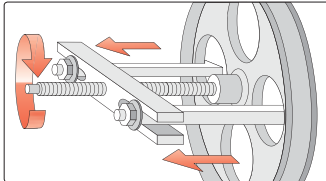
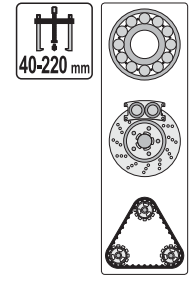

**YATO**  
YT-0640 10

- GB Gear puller set
- D a erabzieher Trennmesser
- PL Ściągacz dwuramienny i separator
- RUS Съёмник универсальный с сепаратором
- CZ Stahovák dvouramenný
- H Csapágyelhúzó készlet
- RO Set angrenaj pt. extras
- F rac eur 2 bras + separateur
- I Estrattore a due bracci a separatore
- E Kit de extractor
- CN 齿轮拉拔器

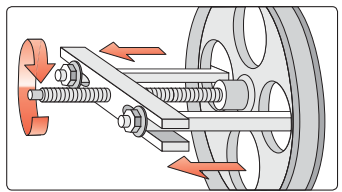
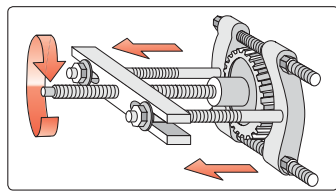
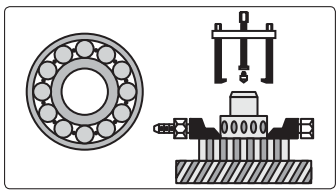
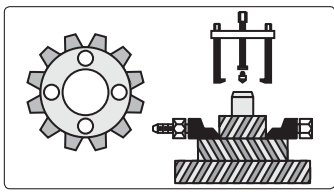
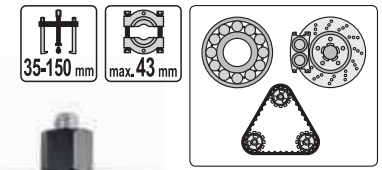

**YATO**  
YT-0641 4

16

- GB Steering wheel remover / lock plate compressor set
- D Abziehvorrichtung für das Lenkrad
- PL Ściągacz koła kierownicy / sprężarki
- RUS Съёмник рулевого колеса
- CZ Přípravek na stahování volantu
- H Kormánykerék-lehúzó
- RO Volar puller
- F Extracteur du volant et du compresseur
- I Se es ra ore smon a io vo an e
- E Desmontador para el volante
- CN 方向盘拆装器



- 5/16" 101 mm 18 TP
- M8 89 mm
- 3/8" 89 mm 16 TP
- 5/16" 89 mm 24 TP
- M14 15 mm
- 9/16" 18 TP

14  
PCS



**YATO**  
YT-2545 10



- GB Slide hammer gear / bearing puller set  
D Träge Abziehvorrichtung für Lager  
PL Ściągacz bezwładnościowy do łożysk  
RUS Инерционный съёмник подшипников  
CZ Rázový stahovák s kluzným kladivem na ložiska  
H Csúszósúlyos csapágyelhúzó készlet

- RO Set ciocan culisant extractor de rulmenti  
F Extracteur de roulements à inertie  
I Se es ra ori in erni / es erni  
E Extractor de inercia para cojinetes  
CN 滑锤轴承拉拔器组套

5  
PCS

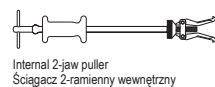
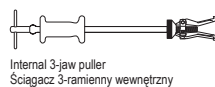
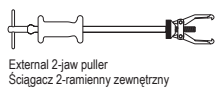
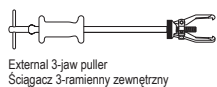
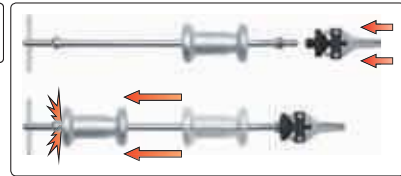

BMC & COLOR SLEEVE

<b>YATO</b>	
YT-2540	2

- GB Slide hammer set  
D Träge Abziehvorrichtung für Naben und Lager  
PL Ściągacz bezwładnościowy do piast i łożysk  
RUS Инерционный съёмник ступиц и подшипников  
CZ Rázový stahovák s kluzným kladivem na náboje a ložiska  
H Csúszósúlyos kerékagy - és csapágyelhúzó készlet

- RO Set ciocan culisant extractor de rulmenti și bucșe  
F Extracteur de roulements et moyeux à inertie  
I Set estrattori per cuscinetti interno  
E Extractor de inercia para cubos y cojinetes  
CN 滑锤轴承拉拔器组套

13  
PCS

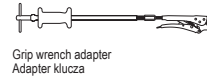
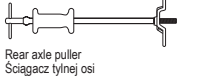
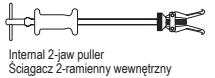
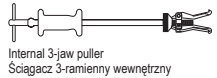
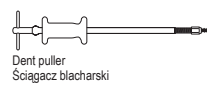
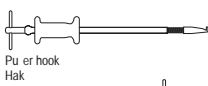
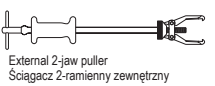
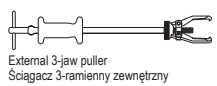
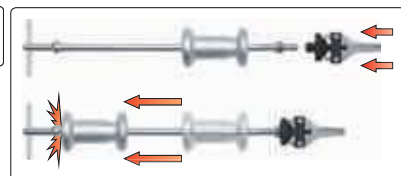

BMC & COLOR SLEEVE

<b>YATO</b>	
YT-2539	2

- GB Front wheel bearing adapter set  
D Radlagerabzieher werkzeugsatz vorderachse  
PL Ściągacz łożysk piasty przedniej  
RUS Набор для снятия переднего подшипника переднеприводных автомобилей  
CZ Sada na demontáž ložisek přední nápravy  
H Csapágyelhúzó adapter készlet első futóműhöz  
RO Set scimbari menținerii roților față  
F Extracteur de moyeux  
I Set estrattori per cuscinetti ruota anteriore adattatore universale  
E Extractor de cojinetes para cubos de rueda delanteros  
CN 轴承拆装组套

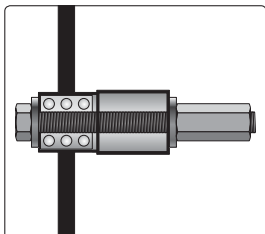

23  
PCS

FOR FRONT WHEEL BEARING  
DO ŁOŻYSK PIASTY PRZEDNIEJ

BMC & COLOR SLEEVE



<b>YATO</b>	
YT-2541	2

GB Small mouth pull clamp  
 D Selbstklemmende Blechschele  
 PL Klamra blacharska samozaciskowa  
 RUS Скрепa самозажимная для жестяных работ  
 CZ Karosárská svěrka samosvorná k tahání

H Önszorító húzóató pofa, egyenes  
 RO Clemă pt. tablă cu strângere automată  
 F Boucle pour tôle auto-serrant

I Grappa  
 E Grapa de hojalatería autoprensora  
 CN 窄型张引夹

**5t** **125 mm** **42x20mm JAWS** **AUTO-TIGHTEN**  
 SZCZĘKI SAMO-ZACISKOWA

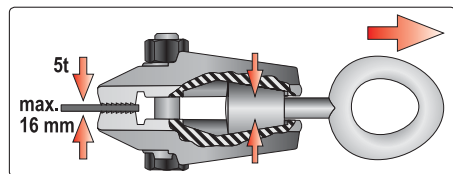

COLOR BOX



<b>YATO</b>	L (mm)	
YT-2542	125	12

GB Box clamp  
 D Selbstklemmende Blechschele vom Typ „C“  
 PL Klamra blacharska samozaciskowa typu „C“  
 RUS Скрепa самозажимная для жестяных работ типа „C“  
 CZ Karosárská svěrka samosvorná k tahání typ „C“  
 H Önszorító húzóató pofa, öblös  
 RO Clemă pt. tablă cu strângere automată de tip „C“  
 F Boucle pour tôle auto-serrant

I Grappa tipo „C“  
 E Grapa de hojalatería autoprensora tipo „C“  
 CN 宽型张引夹

**3t** **142 mm** **35x15mm JAWS** **TYPE C** **AUTO-TIGHTEN**  
 SZCZĘKI SAMO-ZACISKOWA

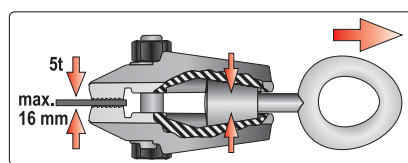

COLOR BOX



<b>YATO</b>	L (mm)	
YT-2543	142	10

GB Twis socke se  
 D Schraubendrehersatz  
 PL Zestaw wykrętaaków do śrub  
 RUS Инструмент для удаления сломанных винтов  
 CZ Sada vyťahováku stržených šroubů  
 H Kicsavaró készlet csavarokhoz

RO Set de chei pt. șuruburi  
 F Set d'extracteurs aux vis  
 I Set estrattori per dadi  
 E Juego de destornilladores  
 CN 螺栓取出器组套

**10 PCS**  
**3/8"**  
**10mm**  
**CrMo**  
**HRC 52-55**

GB Screw extractor set & HSS drill bits  
 D Schraubenausdrehersatz & HSS Bohrer  
 PL Wykrętaaki do zerwanych śrub i wiertła do metalu HSS  
 RUS Экстракторы и сверла по металлу HSS  
 CZ Vrtáky do přetržených šroubů & vrtáky na kov HSS  
 H Törtcsavar kihajtó & főrészár fémhez HSS  
 RO Capete pt. deșurubat șuruburi rupte & burghie pt. metal HSS  
 F Set d'extracteurs aux vis  
 I Estrattori di vite HSS  
 E Destornillador para tornillos arrancados & HSS brocas  
 CN 断丝取出器组套

**12 PCS** **HSS**  
**M3-M24**

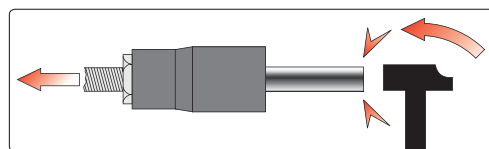

BMC & COLOR BOX



PLASTIC CASE & COLOR BOX



<b>YATO</b>	Ø (mm)	M	Ø [mm]	
YT-0591	1 4-3 6	3-6	1 8	40
	2 1-4 9	6-8	2 6	
	3 1-6 5	8-11	3 7	
	4 8-8 8	11-14	5 5	
	6 2-11 0	14-18	7 0	
	9 4-15 0	18-24	10 3	

<b>YATO</b>		
YT-0603		8/32

GB Screw extractor set  
 D Schraubenausdrehersatz  
 PL Wykrętaaki do zerwanych śrub  
 RUS Набор для извлечения обломанных болтов  
 CZ Vrtáky do přetržených šroubů  
 H Törtcsavar kihajtó  
 RO Capete pt. deșurubat șuruburi rupte  
 F Set d'extracteurs aux vis  
 I Estrattori di viti  
 E Destornillador para tornillos arrancados  
 CN 断丝取出器组套



PLASTIC BOX & SLIDING CARD



**6 PCS**

<b>YATO</b>	Ø (mm)	L (mm)	
YT-0590	3-6	52	12/48
	6-8	58	
	8-11	66	
	11-14	75	
	14-18	80	
	18-25	88	

GB Bo e rac or se  
D Satz von Ausziehvorrichtungen für Stifte  
PL Zestaw wykrętek do szpilek  
RUS Набор экстракторов для шпилек  
CZ Souprava na demontáž závrtných šroubů  
H Csavarkihajító készlet  
RO Set de șurubelnițe pt. tije

F Set d'extracteurs aux épingles  
I Set bussole estrattore per brugola  
E Juego de extractores de alfileres  
CN 断丝取出器组套

BMC & COLOR SLEEVE



STEEL 8660

HRC 49-52

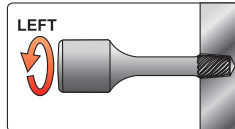

6 PCS

3/8" 10mm

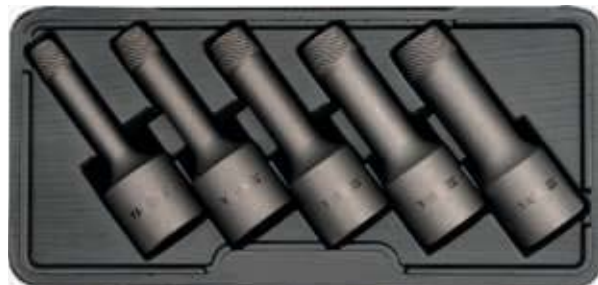

5 PCS

1/2" 12.5mm

YATO	Ø (mm)	
YT-0623	2 3 4 6 8 10	50

YATO	Ø (mm)	
YT-0624	8 10 12 14 16	20

GB Heavy duty nut splitter  
D Meißelsatz für Schraubenmutter  
PL Zestaw przecinaków do nakrętek  
RUS Набор зубил для гаек  
CZ Souprava sekáčů na matice  
H Csavaranya-vágó  
RO Set retezatoare capace  
F Set de burins  
I Set estrattore dado  
E Juego de tajaderas para tuercas  
CN 螺母破拆组套



BMC & COLOR SLEEVE



4 PCS

CrV

HRC 40-45

5/16" - 1/2" (9 - 12 mm);  
1/2" - 5/8" (12 - 16 mm);  
5/8" - 7/8" (16 - 22 mm);  
7/8" - 1-1/16" (22 - 27 mm)

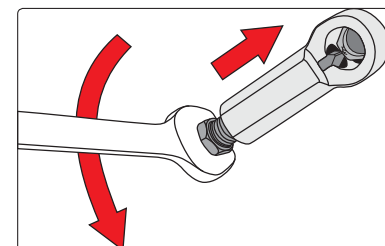

YATO	
YT-0585	10

GB Roller stud extractor set  
D S ehbo zen ósersa z  
PL Komplet wykrętek do szpilek  
RUS Набор ключей для снятия штифтов  
CZ Sada stahovadel na špendlíky  
H Komplet tükihűző  
RO Set de dispozitive pt. demontaj șuruburi rupte  
F Set d'extracteurs de goupilles  
I Estrattori a rulli per viti prigioniere  
E Juego de extractores de agujas  
CN 断丝取出器组套



4 PCS

CrV 50BV30

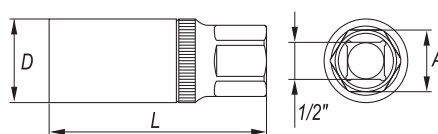
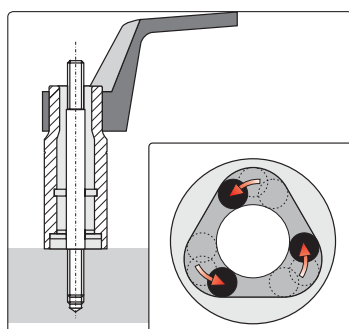

BMC & COLOR SLEEVE



YATO	● (mm)	D (mm)	L (mm)	A (mm)	
YT-0620	6	24	60	21	6/24
	8				
	10	28	70		
	12				

GB Tie rod end lifter  
 D Universal-Kugelgelenk-Abzieher  
 PL Ściągacz do sworzni kulistych  
 RUS Съёмник шаровых опор  
 CZ Stahovák kulových čepů řízení  
 H Gömbfej kinyomó

RO Extractor pt. articulatii sferice  
 F Extracteur de rotue  
 I Estrattore per snodi sferici  
 E Extractor de pernos esféricos  
 CN 球头拉拔器

135 mm



COLOR BOX



YATO	(mm)	L (mm)	Ø (mm)	
YT-0612	19	135	17.5	9/18

GB Tie rod end lifter  
 D Universal-Kugelgelenk-Abzieher  
 PL Ściągacz do sworzni kulistych  
 RUS Съёмник шаровых опор  
 CZ Stahovák kulových čepů řízení  
 H Gömbfej kinyomó

RO Extractor pt. articulatii sferice  
 F Extracteur de rotue  
 I Estrattore per snodi sferici  
 E Extractor de pernos esféricos  
 CN 球头拉拔器

265 mm

275 mm



COLOR BOX



YATO	(mm)	L (mm)	Ø (mm)	
YT-0613	16	265	17	20
YT-0614	16	275	20	20

GB Rod end remover  
 D Lenks an eabzieher  
 PL Ściągacz do drążków kierowniczych  
 RUS Съёмник рулевых тяг  
 CZ Přípravek na demontáž kulových čepů řízení  
 H Gömbfej kiütő  
 RO Tija pt. indepatare  
 F Extracteur pour rotules de direction  
 I Estrattori perni e tiranti sterzo  
 E Extractor de barras de acoplamiento  
 CN 拉拔器



200 mm

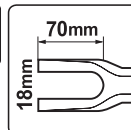

COLOR BOX



YATO	L (mm)	
YT-0615	200	18/36

GB Inner tie rod tool  
 D Spurstangengelenk Lösewerkzeug  
 PL Klucz do drążków kierowniczych  
 RUS Ключ для шарнира рулевой рейки  
 CZ Přípravek na axiální táhla  
 H Csukló szerelő  
 RO Cheia de la tija de cravată  
 F Clé pour rotules de direction  
 I Chiave per il tirante  
 E Extractor mecanismo de dirección  
 CN 大机舵扳手



Ø mm  
35-42

COLOR BOX



YATO		
YT-0616		25

GB Track rod end remover & installer set  
 D Schlüsselsatz für Zahnstangenlenkung  
 PL Zestaw kluczy do drążków kierowniczych  
 RUS Набор ключей для рулевых тяг  
 CZ Sada klíčů pro hřeben řízení  
 H Kormányrúd telepítő készlet-eltávolító  
 RO Îndepărtare & instalare set baghetă de volan  
 F Clé pour rotules de direction  
 I Set di chiavi suggerimenti smon a io iran i serzo  
 E Herramienta de llaves para barras de dirección  
 CN 件套轴接头工具组



4 PCS

Ø mm  
30-45

BMC & COLOR SLEEVE



30-35mm 35-40mm 40-45mm

YATO		
YT-06155		2

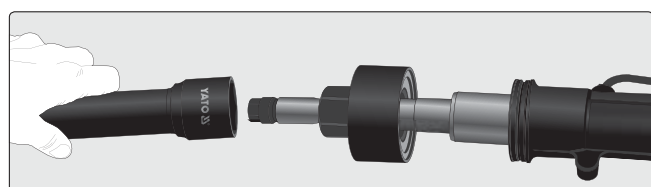

- GB Tie rod / ball joint tool kit
- D Werkzeugsatz für Bremssattel
- PL Ściągacze do drążków
- RUS Съёмник штанг
- CZ Stahováky táhel řízení
- H Rúdlehúzó
- RO Ancore pt. tije
- F Set d'extracteurs pour rotules de direction
- I Set tiranti per estrattore
- E Tensores para palancas
- CN 球头拉拔器组套

6  
PCS



BMC  
& COLOR  
SLEEVE



<b>YATO</b> 	
YT-06157	4

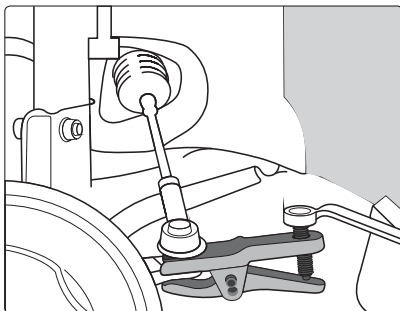

- GB Tie rod / ball joint tool kit
- D Werkzeugsatz für Bremssattel
- PL Ściągacze do drążków
- RUS Съёмник штанг
- CZ Stahováky táhel řízení
- H Rúdlehúzó
- RO Ancore pt. tije
- F Set de leviers à tête réglable
- I Set di estrattori perni e tiranti sterzo
- E Tensores para palancas
- CN 球头拉拔器组套

for / dla: YT-0990



5  
PCS

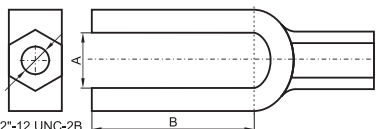
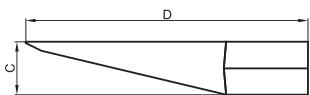
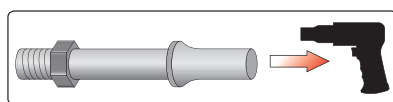
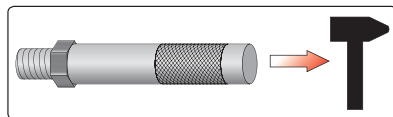

BMC  
& COLOR  
BOX



1/2"-12 UNC-2B

<b>YATO</b> 	A (mm)	(mm)	C (mm)	D (mm)	
YT-0616	18.2	65.0	24.0	123.9	10
	25.2	67.8			
	30.2	56.3			

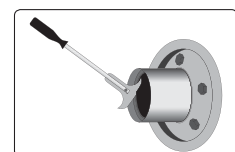

- GB Seal puller
- D Dich un s- bziehwerkzeu
- PL Ściągacz do uszczeltek
- RUS Съёмник прокладок
- CZ Škrabka na těsnění
- H Tömítéslelűzó
- RO Ancoră pt. garnituri
- F Outil pour extraire les joints
- I Estrattore per guarnizioni
- E Tensor para juntas
- CN 密封圈拉拔器



max.  $\varnothing$   
85 mm



SLIDING  
CARD

<b>YATO</b> 	L (mm)	
YT-0642	200	12/48

- GB Bearing race and seal driver set
- D Presssatz für sicherungsringe, lager, etc.
- PL Zestaw do osadzania łożysk i uszczelniaczy
- RUS Втулка и набор сальниковых уплотнителей для автомобиля
- CZ Sada na montáž gufer
- H Csapágy, szimering, persely ki- és beütő készlet
- RO Set pt. inlocuit rulment, simering
- F Set de simerings
- I Set di tamponi per cuscinetti e guarnizioni
- E Jugeo de conductores del anillo y del sello de rodadura
- CN 斜型培令套安装器



10  
PCS

AI

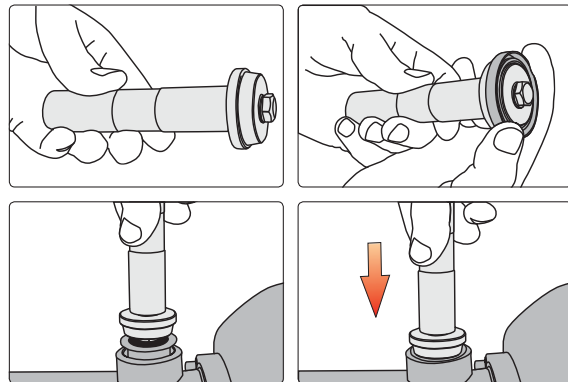

BMC  
& COLOR  
SLEEVE



YATO	No.	Ø (mm)	
YT-0638	01	40	5/10
	02	44	
	03	50	
	04	59	
	05	63	
	06	65	
	07	72	
	08	76	
	09	81	

- GB Car radio removal tool set
- D Autoradio Demontage Werkzeugsatz
- PL Zestaw do demontażu radioodbiorników samochodowych
- RUS Набор для разборки авто-ресиверов
- CZ Sada k demontáži autorádii
- H Autórádió kiszerező készlet
- RO Trusa de scule pt. indepartat radio
- F Set d'outils pour dépose autoradio
- I Set estrattori per autoradio
- E Jugeo para el desmontaje de autorradio
- CN 收音机拆卸组套

SLIDING  
CARD



36  
PCS

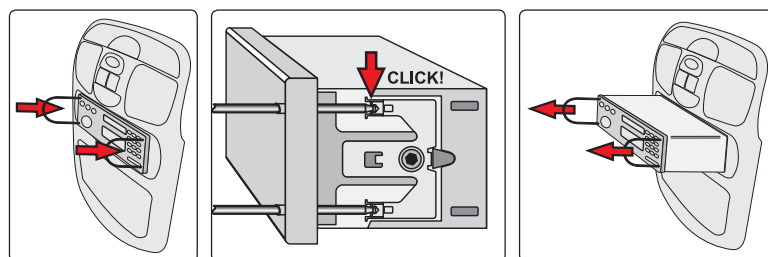
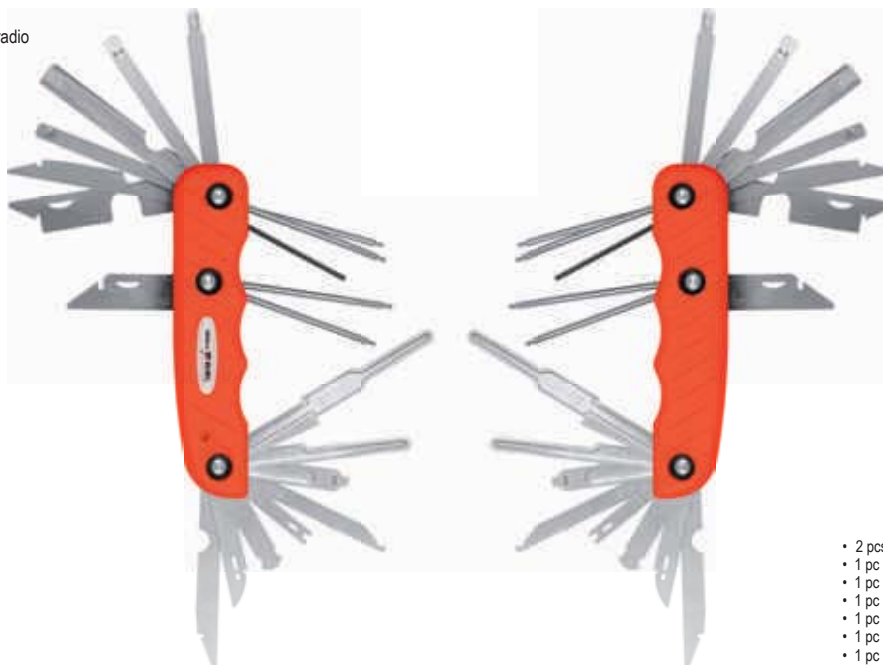

- 2 pcs P-01 Mercedes Benz, VW, Audi, Becker
- 1 pc P-02 Mercedes Benz, Porsche, Becker
- 1 pc P-03
- 1 pc P-04 Skoda
- 1 pc P-05 Becker
- 1 pc P-07 C arion
- 1 pc P-08 Kenwood
- 1 pc P-09 Son
- 1 pc P-10 Kenwood
- 1 pc P-11-1 - Fia Bravo Fia Brava
- 1 pc P-11-2 - Fia Bravo Fia Brava
- 1 pc P-12 - Pioneer, JVC
- 1 pc P-13 - Panasonic
- 1 pc P-14 - Panasonic
- 1 pc P-15 - Son
- 1 pc BM
- 1 pc BMW, Opel
- 2 pcs Opel, Grundig, Blaupunkt
- 2 pcs VW, Audi, Ford

YATO	
YT-08380	12/24

- GB Car radio removal tool set  
GB Car radio removal tool set  
D Autoradio Demontage Werkzeugsatz  
PL Zestaw do demontażu radiodbiorników samochodowych  
RUS Набор для разборки авто-ресиверов  
CZ Sada k demontáži autorádií  
H Autórádió kiserelő készlet  
RO Trusa de scule pt. indepartat radio  
F Set d'outils pour dépose autoradio  
I Set estrattori per autoradio  
E Juego para el desmontaje de autorradio  
CN 收音机拆卸组套

- 2 radio removal U-hook (Ford, VW, Audi, Grundig, Blaupunkt)
- 1 special pentagon wrench (BMW)
- 4 radio removal keys (VW, Audi, Becker, Mercedes)
- 2 radio removal keys (Mercedes, Porsche, Becker)
- 2 radio removal keys (VW 1a and he wrench (BMW, Opel)
- 2 radio removal keys (new Becker)
- 2 radio removal keys (new Skoda)
- 2 radio removal keys U-hook (new Blaupunkt)
- 2 radio removal keys (Fia Brava)
- 2 radio removal U-hook (Opel Doppel-Kugel-Inbus)
- 6 radio removal keys (Mercedes-Benz, BMW)
- 2 radio removal keys (Kenwood II 1998-2001)
- 2 radio removal keys (Son since 2002)
- 2 radio removal keys (Kenwood III since 2002)
- 2 radio removal keys (Pioneer, JVC)
- 2 radio removal keys (Son un i 2001)
- 2 radio removal keys (Panasonic)
- 2 radio removal keys (Kenwood I until 1998)
- 2 radio removal keys (Kenwood mask)
- 2 radio removal keys (new Clarion)
- 2 radio removal keys (old Clarion)
- 2 radio removal keys (Panasonic 2006)
- 2 radio removal keys (Son D C 2005)

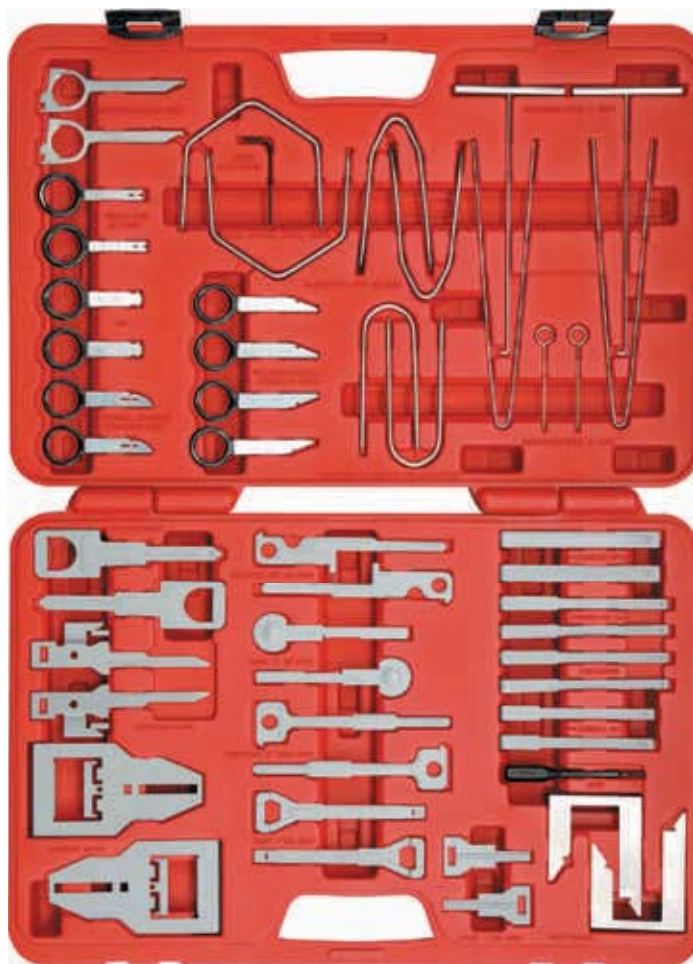

52  
PCS

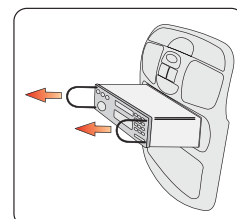
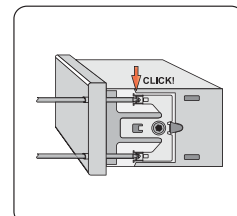
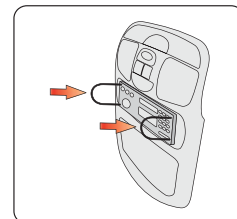

BMC  
& COLOR  
SLEEVE



<b>YATO</b>	
YT-0838	10

- GB Emergency car door opening tool set  
D Werkzeug zur zügigen Öffnung der Autotür im Notfall  
PL Zestaw do awaryjnego otwierania drzwi samochodowych  
RUS Набор для аварийного відкриття автомобільних дверей  
CZ Souprava k nouzovému otevření dveří automobilů  
H Személygépkocsi ajtó vésznyitó készlet  
RO Set pt. deschiderea de avarie a ușilor de mașină  
F Set ouverture de porte fermée  
I Set estrattori per apertura automotore  
E Juego de herramientas para abrir las puertas de coche en casos de urgencia  
CN 车门锁拆卸工具



9  
PCS

STAINLESS  
STEEL  
STAL  
MERZEWA

PVC

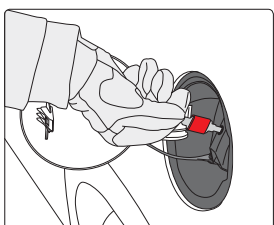
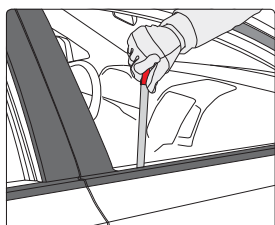
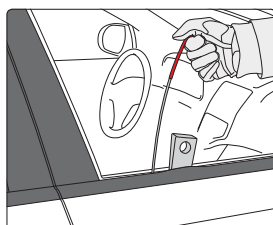
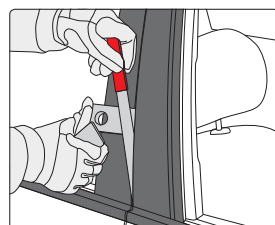

POUCH



<b>YATO</b>	
YT-08385	25

- GB Universa ermina release oo se
- D Werkzeugsatz für Konektorverbindungen
- PL Zestaw do złączy konektorowych
- RUS Комплект для коннекторных разъемов
- CZ Souprava na konektorové spojky
- H Szerszámkészlet konnektoros csatlakozásokhoz
- RO Set pt. cuplării conectoare
- F Set de pincas pour serrer les connecteurs
- I Set di connettori
- E Juego para conexiones de aflojamiento rápido
- CN 端子拆卸器组

**12**  
PCS

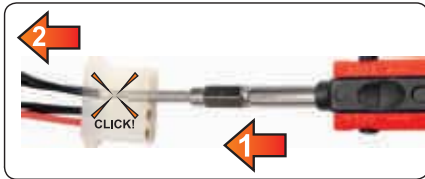

BMC  
& COLOR  
SLEEVE



YATO	No.	description / opis	application / zastosowanie	
YT-08430	C -01 11	ejection tools for contact sizes Ø 1.5 mm w/dismantling sleeves for contact sizes narzędzie do odłączania styków o rozmiarze Ø 1.5 mm wraz z tuleją do demontażu	BMW, Daimler Chrysler, Fiat, MAN, Opel, Porsche, Seat, Skoda, VW, Audi	10
	C -02 12	ejection tools for contact sizes Ø 3.5 mm w/dismantling sleeves for contact sizes narzędzie do odłączania styków o rozmiarze Ø 3.5 mm wraz z tuleją do demontażu	BMW, Daimler Chrysler, Fiat, MAN, Opel, Porsche, Seat, Skoda, VW, Audi	
	C -05 15	ejection tools for contact sizes Ø 2.3 mm w/dismantling sleeves for contact sizes narzędzie do odłączania styków o rozmiarze Ø 2.3 mm wraz z tuleją do demontażu	Ford, Opel, PSA, Renault	
	C -53	cable extractor tool for plugs with one release channel 2.8 and 5.8 mm wykრętał do przewodów z pojedynczym złączem 2.8 i 5.8 mm	BMW, Daimler Chrysler, Ford, MAN, Opel, Porsche, PSA, Renault, Seat, Skoda, VW, Audi	
	C -56	cable extractor tool for Micro timer contacts 1.6 mm wykрętał do przewodów Microtimer I, III styki Ø 1.6 mm	Daimler Chrysler, Opel, Porsche, PSA, Renault, Saab, Seat, Skoda, VW, Audi	
	C -59	cable extractor tool for Maxipower Timer contacts 9.5 mm wykрętał do styków Maxipower Timer 9.5 mm	Daimler Chrysler, VW, Audi	
	C -62	cable extractor tool for Pit-Pod contacts wykрętał do styków Pit-Pod	all vehicles wszystkie pojazdy	
	C -74	cable extractor tool for Microtimer I contacts and ABS plug-in housing Ø 1.6 mm wykрętał do styków Microtimer I i osłony wtyku ABS Ø 1.6 mm	Fiat, Ford, Mazda, Opel, PSA, Renault, Saab, VW, Audi	
	C -91	cable extractor tool for plugs with two release channels 2.8 and 5.8 mm wykрętał do przewodów z podwójnym złączem 2.8 i 5.8 mm	BMW, Daimler Chrysler, Fiat, Ford, MAN, Opel, PSA, Renault, Saab, VW, Audi	

- GB Airbag removal key set
- D Schlüssel zur Demontage des Luftkissen
- PL Klucze do demontażu poduszki powietrznej
- RUS Набор ключей для демонтажа подушки безопасности
- CZ Klíče na demontáž airbagu
- H Kulcsok légszék leszereléséhez
- RO Chei pt. demontare airbag
- F Kit outils spéciaux airbag
- I Set chiavi per smontaggio airbag
- E Llaves para desmantelamiento de bolsas de aire
- CN 安全气囊拆卸组套

**16**



**12**  
PCS

**HRC**  
45-50

**CrV**  
6150

BMC  
& COLOR  
SLEEVE



for / dla: BMW, Audi, Opel, Renault, Mercedes, VW Passat, VW Polo, VW Lupo, VW Golf 4, VW Beetle, VW Jetta, VW Bora, Seat, Skoda Fabia, Skoda Octavia

**YATO**  
YT-06291

**10**



GB Door upholstery remover  
D Abziehvorrück un  
für Polstererklammern  
PL Ściągacz do spinek tapicerk  
RUS Съёмник крепежа обивки  
CZ Uvolňovač čalounění dveří

H Kárpitkiszedő  
RO Dispozitiv de scoas agrafe  
de tapițerie  
F Tranche a rafes  
I Estrattore per la rimozione  
di graffette tappezzeria

E Extractor de grasas  
de vestidura  
CN 胶扣起子

SVCM



YATO	size / rozmiar (mm)	
YT-1370	6 100	12/120

YATO	size / rozmiar (mm)	
YT-1371	6 2 115	12/120



YATO	size / rozmiar (mm)	
YT-1372	10 115	12/120

YATO	size / rozmiar (mm)	
YT-1373	9 5 134	6/96

GB Screw  
D Einfache Spicknadel  
PL Szpikulac prosty

RUS Прямое остриё  
CZ Šídlo rovné  
H Spékélotű, egyenes

RO Dorn perforare drept  
F Brochette droite  
I Punteruolo piatto

E Punzón recto  
CN 锥子

SVCM



YATO	L (mm)	
YT-1374	120	12/120

GB Hook bodkin  
D Hakenspicknadel  
PL Szpikulac hakowy

RUS Крюковое остриё  
CZ Šídlo háčkové  
H Spékélotű, horgos

RO Dorn perforare indoit  
F Brochette coudée  
I Gancio punteruolo

E Punzón encorvado  
CN 油封拉拔器

SVCM



45°

90°

YATO	L (mm)	
YT-1376	90	12/120

YATO	L (mm)	
YT-1375	125	12/120

GB Battery cap tool  
D Abziehvrichtung für Akkuklemmen  
PL Ściągacz do klemm akumulatora  
RUS Стяжка для клемм аккумулятора  
CZ Stahovák svorek akumulátoru  
H Akkumulátor saru lehzó  
RO Extractor pt. cleme acumulator

F Tournevis plat pour  
bouchons de batterie  
I Ba eria c em es ra ore  
E Extractor para los bornes  
de la batería  
CN 扁铲

SVCM



YATO	size / rozmiar (mm)	
YT-1378	18 5 100	12/120

GB Glass scraper  
D Scheibenkra zer  
PL Skrobak do szyb  
RUS Шабер для скла

CZ Škrabka na okna  
H Jégkaparó  
RO Răzuitor geamuri  
F Gratteur pour vitres

I Raschietto per vetro  
E Rascador para  
los vidrios  
CN 刮刀

SVCM



YATO	size / rozmiar (mm)	
YT-1379	39 200	6/72

GB Spare blades for glass scraper  
D Abbrechkin en  
PL Ostrze do skrobaka do szyb  
RUS Лезвия для универсальных ножей  
CZ Lomené ostří náhradní  
H Törhető tartalékpenge  
RO Lame de rezervă rupte  
F Lames pour gratteur pour vitres  
I Lame per raschietto  
E Filo partido de recambio  
CN 刮刀刀片

COLOR BOX 

10 PCS SK5

for / dla: YT-1379



YATO	size / rozmiar (mm)	
YT-13790	19 39	50

GB Flexible spinner handle  
D Gasischer Dreher  
PL Pokręto elastyczne  
RUS Эластичный вороток

CZ Šroubovák ohebný  
H Hajlékony csavarhúzó  
RO Mâner flexibil  
F Barre élastique

I Chiave flessibile  
E Llave flexible  
CN 套筒螺丝批

1/4"

6.3mm

SVCM



YATO	size / rozmiar	
YT-1381	1/4" (6.3 mm) 150 mm	6/96

GB Flexible magnetic bit driver  
 D Elastischer Dreher für Bits  
 PL Pokrętko elastyczne do bitów  
 RUS Эластичный вороток для разряда битов

CZ Šroubovák ohebný na bity  
 H Hajlékony csavarhúzó bit  
 RO Mâner flexibil pt. vârf șurubelniță  
 F Barre élastique

I Chiave flessibile  
 E Mango flexible para desarmadores  
 CN 批头螺丝批



YATO	size / rozmiar	
YT-1382	1/4" (6.3 mm)	380 mm 6/72

GB Flexible magnetic pick up tool  
 D asische Magnetaufnahme  
 PL asz czn uchwytna magnetyczna  
 RUS Эластичный магнитный держатель

CZ Ohebný magnetický držák  
 H Hajlékony mágneses szár  
 RO Mâner magnetic flexibil  
 F Capteur magnétique

I Chiave flessibile  
 E Mango magnético flexible  
 CN 拾拾器



YATO	L (mm)	
YT-1385	400	6/72

GB Flexible hose clip screwdriver  
 D Steckschlüssel, elastisch  
 PL Klucz nasadowy elastyczny  
 RUS Эластичный торцевой ключ

CZ Klíč nástrčný ohebný  
 H Hajlékony dugókulcs  
 RO Cheie tubulara flexibil  
 F Clé à tube élastique

I Chiave a tubo flessibile  
 E Llave de tubo flexible  
 CN 螺帽螺丝批



YATO	size / rozmiar (mm)	
YT-1390	6 150	6/96



YATO	size / rozmiar (mm)	
YT-1391	7 150	6/96



YATO	size / rozmiar (mm)	
YT-1392	8 150	6/96

16

GB Hook screwdriver  
 D Winkelschraubendreher  
 PL Wkrętkak kątowy  
 RUS Отвёртка

CZ Šroubovák  
 H Csavarhúzó  
 RO Șurubelniță  
 F Tournevis coudé

I Cacciavi e ancore  
 E Destornillador  
 CN 螺丝批钩子



YATO	PCS	PCS packing	
YT-28480	6	12	36/144

GB Door upholstery remover  
 D bziehvorruch un für Polstererklammern  
 PL Ściągacz do spinek tapicerek  
 RUS Съемник крепежа обивки

CZ Uvolňovač čalounění dveří  
 H Kárpitkiszedő  
 RO Dispozitiv de scos agrafe de tapiterie  
 F Spatule d'extraction de clips

I Estrattore per la rimozione di graffette tappezzeria  
 E Extractor de grapas de vestidura  
 CN 胶扣起子

SLIDING CARD



YATO	L (mm)	
YT-0841	230	16/64

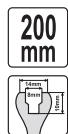

YATO	L (mm)	
YT-0842	200	25/100

- GB Pane remove se
- D Abziehvorrichtung für Polsterung
- PL Ściągacze do tapicerki
- RUS Съёмник обивки
- CZ Sada k demontáži čalounění
- H Kárpitlehúzó
- RO Ancore pt. tapiterie
- F Set d'extracteurs à la tapisserie
- I Leve in plastica per la tappezzeria
- E Tensores para las vestiduras
- CN 面板拆卸组套

DOUBLE  
BLISTER



IMPACT  
RESISTANT  
NYLON  
ODPORNE  
NA UDERZENIA

NO SCRATCH  
BEZ  
ZADRAPAN

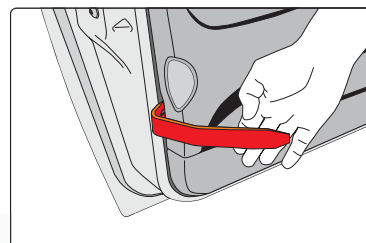

**5**  
PCS

**6**  
PCS



<b>YATO</b>	
YT-0836	6/24

<b>YATO</b>	
YT-0837	6/24

- GB Pane remove se
- D Abziehvorrichtung für Polsterung
- PL Ściągacze do tapicerki
- RUS Съёмник обивки
- CZ Sada k demontáži čalounění
- H Kárpitlehúzó
- RO Ancore pt. tapiterie
- F Set d'extracteurs à la tapisserie
- I Leve in plastica per la tappezzeria
- E Tensores para las vestiduras
- CN 面板拆卸组套

POUCH  
& COLOR  
BOX



**11**  
PCS

- GB Set of plastic scrapers
- D Satz von Kunststoffschabern
- PL Zestaw skrobaków plastikowych
- RUS Набор пластмассовых шпателей
- CZ Souprava plastových škrabek
- H Műanyag vakaró készlet
- RO Set de răzuitoare din plastic
- F Kit de grattoirs en plastique
- I Set di raschietto
- RUS Juego de rascadores de plástico
- CN 塑料刮刀

**4**  
PCS

**265**  
mm

IMPACT  
RESISTANT  
NYLON  
ODPORNE  
NA UDERZENIA

NO SCRATCH  
BEZ  
ZADRAPAN



<b>YATO</b>	
YT-0844	5/10



3/4" (19 mm)    7/8" (22 mm)    1" (25 mm)    1 1/2" (37.5 mm)

SLIDING  
CARD



<b>YATO</b>	L (mm)	
YT-0847	265	6/36

- GB Multiposition pry bar set
- D Steckschlüsselsatz mit regulierbaren Kopfstück
- PL Zestaw dźwigni z regulowaną główką
- RUS Комплект рычагов с регулируемой головкой
- CZ Sada páčidel s nastavitelnou hlavou
- H Szabályozható fejű emelőkar készlet
- RO Set de leviere cu cap reglabil
- F Set de leviers à tête réglable
- I Se eva con es a orien abi e
- E Juego de palancas con cabeza ajustable
- CN 多用途撬棒组套

**3**  
PCS

**10"**  
250mm

**12"**  
300mm

**15"**  
380mm

22mm

LOCK  
SYSTEM  
SYSTEM  
BLOKADY

**CrV**



BMC  
& COLOR  
SLEEVE



<b>YATO</b>	
YT-06161	10

- GB Quick release cut out tool
- D Schneidmesser für Scheiben
- PL Nóż do wycinania szyb
- RUS Нож для вырезания стекол
- CZ Nůž na vyřezávání skel
- H Szélvédőkivágó kés
- RO Cuțit tăietor de geam
- F Kit de découpe pare-brise
- I Tagliolo per il vetro
- E Cuchilla para cortar cris a es
- CN 玻璃橡胶刮除器



**3x**  
BLADES  
OSTRZA

**Alu**  
HANDLE  
UCHWYT

**QUICK**  
RELEASE  
SZYBKO-  
ZŁACZE

**K5**

SLIDING  
CARD



- GB Spare blades for cut out tool
- D bbrechkl in enn
- PL Ostrza zapasowe do noża do wycinania szyb
- RUS Лезвия для ножей
- CZ Ostrí náhradní
- H Törhető tartalékpenge
- RO Rezerve cu er
- F ames
- I Lama di ricambio per coltello specialistica per tagliare vetri del auto
- E Filo partido de recambio
- CN 玻璃橡胶刮除器刀片



**3x**  
BLADES  
OSTRZA

**K5**

for / dla: YT-0659

SLIDING  
CARD



3/4" (19 mm)  
1" (25 mm)  
1-1/2" (38 mm)

**YATO**  
YT-0659 20/40

**YATO**  
YT-06590 10/80

- GB Windshield removal set
- D Demon a esa z für Autoscheiben
- PL Zestaw do demontażu szyb samochodowych
- RUS Набор для демонтажа автостекл
- CZ Souprava na demontáž au oske
- H Szélvédőcsereológ szett
- RO Set pt. demontarea geamurilor de mașină
- F Kit pour démontage de vitres de voiture
- I Set di strumenti di rimozione parabrezza
- E Juego para desmontaje de cristales de coches
- CN 风挡玻璃拆卸组套



**7**  
PCS

**HRC**  
38-42

COLOR BOX



**YATO**  
YT-0845 10

- GB Windscreen wiper arm removal tool
- D bziehvorrich un für die Scheibenwischerarme
- PL Ściągacz do ramion wycieraczek
- RUS Съемник поводков стеклоочистителя
- CZ Stahovák na ramínka stěračů
- H Ablaktörökár lehűző
- RO Siguranță pt. brațele ștergătoarelor
- F Bord aux bras d'essuie-glace
- I Estrattore di parabrezza tergicristallo braccio
- E Herramienta para desmontaje de las plumas de los limpiaparabrisas
- CN 雨刷臂拆卸工具

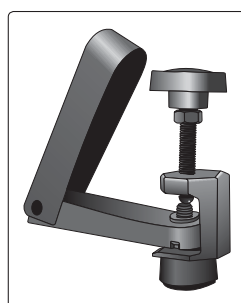

SLIDING  
CARD



**YATO**  
YT-0846 12/120

- GB Air condition repair set
- D Schlüsselsatz für die Klimatisierung
- PL Zestaw kluczy do klimatyzacji
- RUS Набор ключей для кондиционеров
- CZ Sada klíčů na klimatizace
- H Kulcskészlet légkondicionáléhoz
- RO Set de chei pt. aer conditionat
- F Set de clés pour climatisation
- I Set di chiavi per l'aria condizionata
- E Juego de llaves para los sistemas de aire acondicionado
- CN 空调维修工具组套



**12**  
PCS

**1/4"**  
6.3mm

**FOR A/C**  
DO KLIMA-  
TYZACJI

**CrV**

**S2**

**8 POINTS**  
**8 PUNKTÓW**

BMC  
& COLOR  
SLEEVE



**YATO**  
YT-06271 10/40

1/4" (6.3 mm): 2.2 mm, 3.2 mm; CrV;

1/4" (6.3 mm): 12 mm, 15 mm; CrV;

1/4" (6.3 mm); CrV;

1/4" (6.3 mm): TS10, TS15, TS20, TS25, TS27, TS30, TS40 (L=25 mm); AISI S2

- GB CV boot clamp pliers  
D Zange für Schellen der Gelenkabdeckung  
PL Szczypce do opasek osłony przegubu  
RUS Щипцы для хомутов крепления кожуха шарнира  
CZ Kleště na spony manžety kloubu  
H Féltengely bilincs húzó fogó  
RO Clește pt. brățară de husă la articulație  
F Pince pour collier à recouvrement de joint  
I Pinza a morsetto per fascette pinzabili  
E Alicates para abrazadera de protección de la junta  
CN 夹紧钳

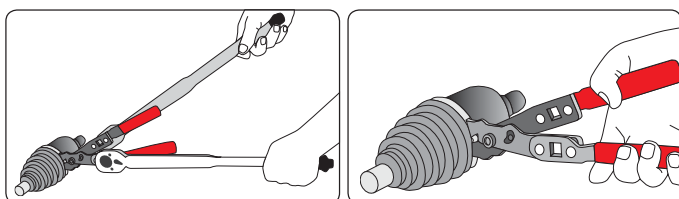

<b>YATO</b>	L (mm)	
YT-0606	235	6/36

- GB Lock-ring pliers  
D Spreizzange für Schellen  
PL Szczypce rozporowe do pierścieni osadczyc  
RUS Щипцы распорные для стяжных хомутов  
CZ Kleště na hadicové spony  
H Seeger fogó  
RO Clește pt. desfacerea brățarelor de strângere  
F Pince tenaille pour les bagues de retenue  
I Pinza per rondelle elastiche scanalata  
E Alicates para abrazaderas  
CN C 型扣钳



<b>YATO</b>	L (mm)	
YT-0607	225	12/72

- GB Transmission line disconnect tool set  
D erkezu sa z zum Trennen von Kraftstoffleitungen  
PL Zestaw do rozłączania przewodów  
RUS Набор для рассоединения топливopроводов  
CZ Sada na rozpojování palivového potrubí  
H Üzemanyagszó-lebontó készlet  
RO Set pt. deconectarea liniilor de combustibil  
F Set pour disjoindre des câbles  
I Set per scollegare i tubi di carburante  
E Juego para desconectar conductos de combustible  
CN 油管拆卸组套



8 PCS  
**FOR A/C**  
DO KLIMATYZACJI  
**FOR FUEL LINE**  
DO PRZEWODÓW PALIWA

BMC & COLOR SLEEVE



- GB Fuel feel pipe pliers  
D Zange für Tankverschlüsse  
PL Szczypce do złączek paliwowych  
RUS Щипцы для топливных соединений  
CZ Kleště na spojky palivového systému  
H Üzemanyagvezeték fogó  
RO Clește pt. conectoare de combustibil  
F Pince tenaille pour connecteurs de carburant  
I Pinza per tubo carburante  
E Alicates para enchufes de combustible  
CN 油管钳

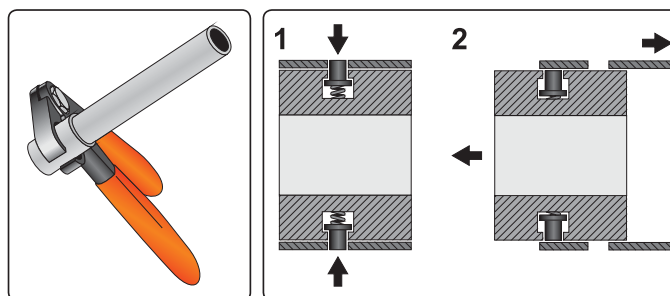
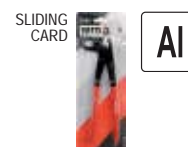

<b>YATO</b>	
YT-0608	10/40

- GB Hose removing pliers  
D Schlauch- und Kabellösezange  
PL Szczypce do zdejmowania przewodów  
RUS Клещи для снятия изоляции  
CZ Kleště na demontáž hadic  
H Tömlőbilincs fogó  
RO Clește pt. indepartat furtune  
F Pince pour enlever les fils  
I Pinza spelacavi universale  
E Alicates de extracción de mangueras  
CN 油管分离钳



<b>YATO</b>	
YT-0657	6/36

<b>YATO</b>	
YT-0630	20

- GB Spark plug puller set VAG
- D Abzieher-Satz Zündspulen VAG
- PL Zestaw ściągaczy do cewek zapłonowych VAG
- RUS Набор съёмников для катушек зажигания VAG
- CZ Sada stahováků zapalovací cívký
- H Gyújtótekercs lehúzó készlet
- RO Set bobina de aprindere tragator
- F Set d'extracteurs des bobines d'allumage
- I Set per la rimozione rapida bobine di accensione nelle auto VAG
- E rac ores bobinas de encendido grupo VAG
- CN 四件套火花塞维修工具



4  
PCS  
FOR / DLA  
**V.A.G.**

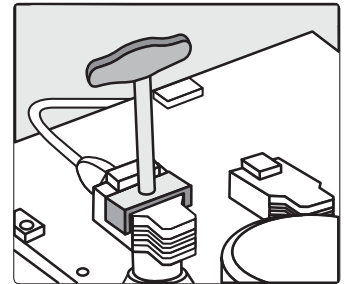

for / dla: VW, Audi, Skoda, Seat

YATO				
YT-06205	T type 1		Volkswagen FSI Golf / Bora 1998, Polo 2002, Touran 2004, New Beetle 2003, Passat 1997, T4+Audi A2 2001	10
	T type 2		Sinik/en ines 6 c 24 5 c Gof / Bora 1998 Passa / Touare 1997 Sharan 1996 Phae on / Toure 6 c 2003 T5 z 6 c sinikiem 2004	
	T type 3		Volkswagen silnik / engines 2.0 z bezp. wtrysk / direct injection, Touran 2004, Passat 2006, Audi z bezp. wtrysk / direct injection A3 2.0 2004, A6 3.2 2005	
	T type 4		Volkswagen z bezp. wtrysk / direct injection 2.0, Golf / Touran 2004, Passat 2006, Audi z bezp. wtrysk / direct injection, A3 2.0 2004, A6 3.2 2005	

- GB Spark plug terminal pliers
- D Zange für das Zündkerzenkabel
- PL Szczypce do przewodów świec zapłonowych
- RUS Щипцы к проводам свечей зажигания
- CZ Kleště na kabely zapalovacích svíček
- H Gyújtógyertya-kábel fogó
- RO Clește pt. conductele bujiilor de aprindere
- F Pince pour fils d'allumage
- I Pinze per candele
- E Pinzas para los cables de las bujías de ignición
- CN 火花塞高压线钳

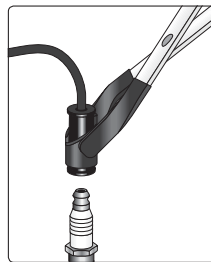

SLIDING CARD



200  
mm  
255  
mm



YATO	L (mm)		YATO	L (mm)	
YT-0639	200	12/96	YT-7320	255	10/60

16

- GB Multi-purpose hose & wire pliers
- D Zangensatz für Schellen und Leitungen
- PL Komplet szczypiec do opasek i przewodów
- RUS Набор щипцов к хомутам и проводам
- CZ Souprava kleští na spony a hadice
- H Fogókészlet bilincsekhez s veze kekhez
- RO Set clește pt. benzi și conducte
- F Pince pour collier de serrage
- I Set pinze per il morsetto
- E Juego de pinzas para abrazaderas y cables
- CN 多功能管夹钳

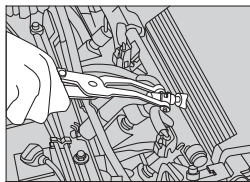

For engine air pipe  
Do przewodów powietrznych listwy wtryskowej

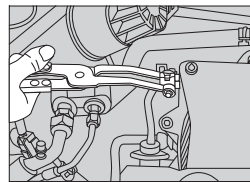

For engine intake air pipe  
Do przewodów gumowych układu zasilania

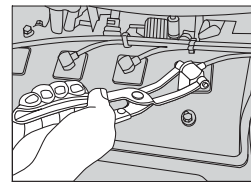

For spark plug lead  
Do przewodów zapłonowych

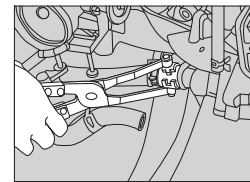

For cooling water pipe  
Do przewodów gumowych układu chłodzenia

2  
PCS  
1/4"-3/4"

6.3-19.0  
mm

217  
mm

254  
mm



SLIDING CARD



YATO	L (mm)	
YT-0645	217	6/24
	254	

GB Hose clamp pliers  
D Zange zum Entspannen der Klemmschellen  
PL Szczypce do opasek zaciskowych rozprężnych  
RUS Щипцы к хомутам зажимным распорным  
CZ Kleště na samosvorné hadicové spony  
H Vízcsőbilincsfogó

RO Clește pt. benzile de strângere destindere  
F Pince pour collier de serrage  
I Set pinze per il morsetto  
E Pinzas para las abrazaderas de expansión  
CN 管夹钳

SLIDING  
CARD

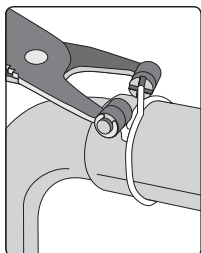
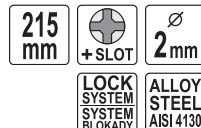

YATO	L (mm)	
YT-0646	215	12/72

GB Hose clamp pliers  
D Zange zum Entspannen der Klemmschellen  
PL Szczypce do opasek zaciskowych rozprężnych  
RUS Щипцы к хомутам зажимным распорным  
CZ Kleště na samosvorné hadicové spony  
H Vízcsőbilincsfogó

RO Clește pt. benzile de strângere destindere  
F Pince pour collier de serrage  
I Set pinze per il morsetto  
E Pinzas para las abrazaderas de expansión  
CN 管夹钳

SLIDING  
CARD

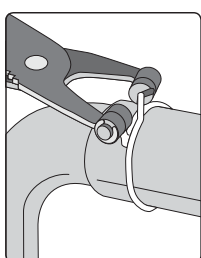
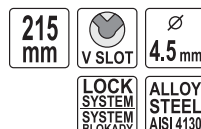

YATO	L (mm)	
YT-0647	215	12/72

GB Hose clamp pliers  
D Zange zum Entspannen der Klemmschellen  
PL Szczypce do opasek zaciskowych rozprężnych  
RUS Щипцы к хомутам зажимным распорным  
CZ Kleště na samosvorné hadicové spony  
H Vízcsőbilincsfogó

RO Clește pt. benzile de strângere destindere  
F Pince pour collier de serrage  
I Set pinze per il morsetto  
E Pinzas para las abrazaderas de expansión  
CN 管夹钳

SLIDING  
CARD

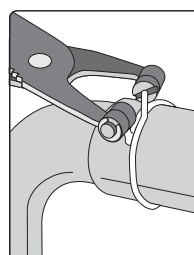

230  
mm

YATO	L (mm)	
YT-0650	230	6/36

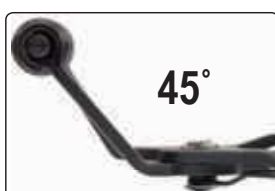

45°



215  
mm

YATO	L (mm)	
YT-0651	215	6/36

GB Exhaust pipe clamp pliers  
D Auspuffschellen-Sicherungs zange  
PL Szczypce do opasek wydechu  
RUS Щипцы для пружинных зажимов  
CZ Kleště na spony výfuku  
H Kipufogóbilincsfogó

RO Clește pt. coliere teava de esapament  
F Pince pour collier d'échappement  
I Set pinze per il morsetto  
E Pinzas para bridas del tubo de escape  
CN 排气管夹钳

SLIDING  
CARD



300  
mm

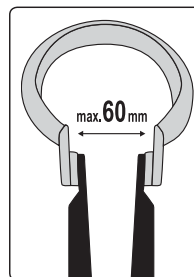

YATO	L (mm)	
YT-0652	300	10/40

for / dla: Peugeot, Citroën,  
Renault, Fiat, Ford

- GB Valve stem seal pliers
- D Lange Zange für Ventildichtringe
- PL Szczypce do uszczelniaczy zaworowych, długie
- RUS Щипцы для замены маслосъемных колпачков
- CZ Kleště na těsnění ventilů, dlouhé
- H Szelepszár szimering fogó hosszú

- RO Clește cu picior lung pt. sigilat supape
- F Pince pour joints de queues de soupapes
- I Pinza per tenuta anello stelo valvola
- E Pinzas para juntas de vástagó válvula
- CN 气门油封钳

SLIDING CARD



**270 mm**

FOR VALVE STEM SEALS  
DO USZCZELNIACZY ZAWOROWYCH

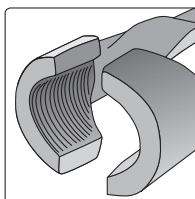

**NON-SLIP**



YATO	L (mm)	Box
YT-0648	270	12/60

- GB Pliers for band clips with a cord
- D Zange für Rohrschellen mit Seil
- PL Szczypce z linką do oprasek zaciskowych
- RUS Щипцы к зажимным хомутам с тросиком
- CZ Kleště s lanekem na samosvorné hadicové spony
- H Flexibilis bowdenes vízcőbilincs fogó
- RO Clește pt. cleme de prindere frânghie

- F Pince pour collier de serrage
- I Pinza per il montaggio e lo smontaggio delle clips elastiche
- E Pinzas para bandas de apretadura con cuerda
- CN 延长型弹性管夹钳

SLIDING CARD



**CrMo 4140**

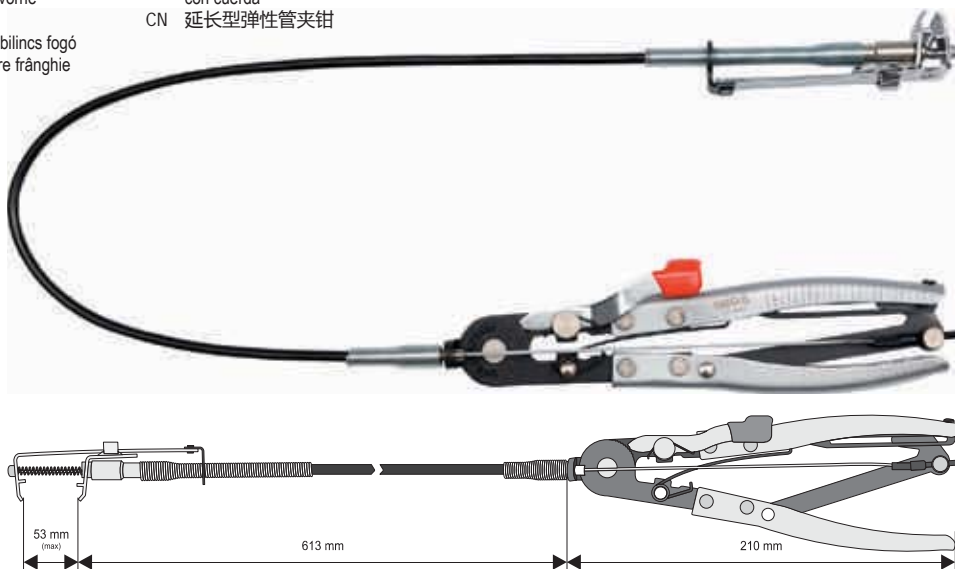

YATO	Box
YT-0653	12/36

- GB Pliers for band clips with a cord
- D Zange für Rohrschellen mit Seil
- PL Szczypce z linką do oprasek zaciskowych
- RUS Щипцы к зажимным хомутам с тросиком
- CZ Kleště s lanekem na samosvorné hadicové spony
- H Flexibilis bowdenes vízcőbilincs fogó
- RO Clește pt. cleme de prindere frânghie

- F Pince pour collier de serrage
- I Pinza per il montaggio e lo smon a io delle clips elastiche
- E Pinzas para bandas de apretadura con cuerda
- CN 延长型弹性管夹钳

SLIDING CARD



**CrMo 4140**

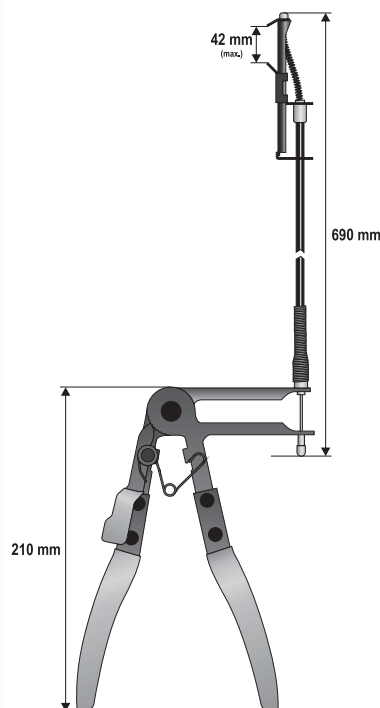

YATO	Box
YT-0677	25



- GB Hose clip pliers  
D Sch auchk emmzan e  
PL Szczypce do opasek zaciskowych typu CLIC i CLIC-R  
RUS Плоскогубцы для зажима шлангов хомуты, CLIC-R  
CZ Kleště na hadicové spony  
H Tömöbilincs fogó  
RO Cleste furturn clip  
F Pince pour collier de serrage  
I Pinza per fascetta a CLIC e CLIC-R  
E Alicates abrazaderas  
CN 压线钳



SLIDING CARD



170 mm

CLIC CLIC-R

YATO	L (mm)	
YT-06475	170	15/60

- GB Water pump pulley locking wrench  
D Schlüssel für die Wasserpumpe  
PL Klucz do pompy wodnej  
RUS Ключ к водному насосу  
CZ Klíč na vodní čerpadlo  
H Vízpumpafogó
- RO Cheie pt. pompe de apă  
F Clé de blocage pour pompe à eau  
I Chiave per la pompa del acqua  
E Llave paral la bomba de agua  
CN 水泵皮带轮扳手

SLIDING CARD



245 mm

285 mm

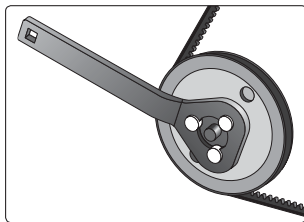

Volkswagen and Audi without air condition  
Volkswagen i Audi bez klima zac i



Volkswagen and Audi with air condition  
Volkswagen i Audi z klimatyzacją

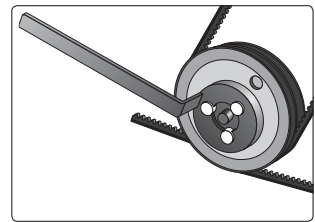

YATO	L (mm)	
YT-0539	245	6/36

YATO	L (mm)	
YT-0540	285	6/36

- GB Tensioner pulley wrench  
D Zahnriemen Spannrollenschlüssel  
PL Klucz do rolki napinającej  
RUS Ключ для регулировки натяжного
- CZ Klíč na napínák  
H Bordás szij feszítő  
RO Cheie de pretensionare a centurilor  
F Clé pour rouleau de tension
- I Chiave per il rullo tenditore  
E Llave del tensor de la correa dentada  
CN 滑轮定时扳手

SLIDING CARD



32 mm



YATO	
YT-06273	20/100

- GB Universal pulley holder & fan clutch set  
D Schlüssel zum Spannen der Riemenscheibe  
PL Klucz do napinania koła pasowego
- RUS Ключ для натягивания шкива  
CZ Klíč k napínání řemenice  
H Szijtárcsa feszítő kulcs  
RO Cheie pt. întindere roată de curea
- F Clé universelle pour poulie  
I Blocca puleggia  
E Llave tensora para polea  
CN 多形式皮带轮扳手



11 PCS

BMC & COLOR SLEEVE

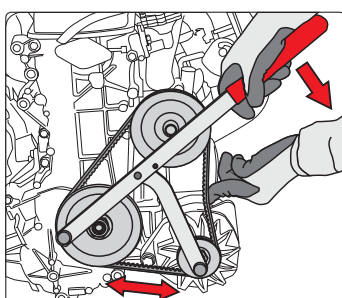

6-10 mm  
8-11 mm  
10-12 mm  
11-16 mm

YATO	
YT-0627	8

GB Piston ring compressor H Gyűrűbepattintó  
 D Kolbenring-Spannband RO Clește pt. strâns inele  
 PL Zaciskacz do pierścieni F Compresseur  
 RUS Оправка поршневых колец de segments de piston  
 CZ Svěrka na kroužky I Morsetto per anelli

E Apretador de anillos  
 CN 活塞环压缩机

AISI #301 SK5

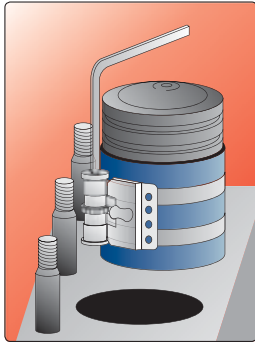

COLOR BOX

YATO	Ø (mm)	H (mm)	Box
YT-0635	50-125	75	30/60
YT-0636	90-175	100	30/60
YT-0637	90-175	150	20/40

GB Belt tensioner H Merszfeszessé  
 D Werkzeug Spannungsprüfer  
 PL Przyrząd do kontroli napięcia paska rozrządu  
 RUS Прибор для проверки натяжения ремней  
 CZ Přípravek pro kontrolu napnutí rozvodového řemene  
 H Merszfeszessé  
 RO Tester intindere curea de distributie cu gradatie  
 F Controleur de tension de courroie  
 I Strumento per il controllo rapido della tensione cinghia distribuzione  
 E Medidor para determinar la tensión de la correa  
 CN 皮带张紧器

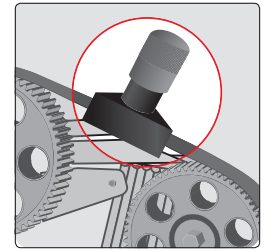

COLOR BOX

YATO	Box
YT-06019	20

GB Twin cam locking tool for petrol & diesel engines  
 D Universelle Blockade der Steuerwellen  
 PL Uniwersalna blokada wałków rozrządu  
 RUS Универсальный набор блокировки распредвала  
 CZ Univerzální přípravek na zablokování rozvodných hřídelí  
 H Univerzális vezérműtengely rögzítő

RO Blocadă universală arbore de direcție  
 F Outil de blocage d'arbre à cames  
 I Universale strumento di bloccaggio a camme  
 E Bloqueo universal de eje de distribución  
 CN 双凸齿轮固定器

FOR PETROL & DIESEL ENGINES  
 DO SILNIKÓW DIELSA I BENZYNOWYCH

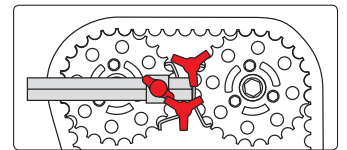

SLIDING CARD

YATO	Box
YT-06011	10/20

16

GB Camshaft lock pin  
 D Nockenwellen-Verriegelungswerkzeug  
 PL Przyrząd do blokowania kół rozrządu  
 RUS Инструмент для блокирования распределительных механизмов  
 CZ Přípravek k montáži rozvodových kol  
 H Vezérlés rögzítő szerszám  
 RO Arbore cu came  
 F Outil de blocage d'arbre à cames  
 I Set di serrature di temporizzazione  
 E Aparato para bloquear el árbol de levas  
 CN 正时皮带固定器

SLIDING CARD  
  
**48 mm**

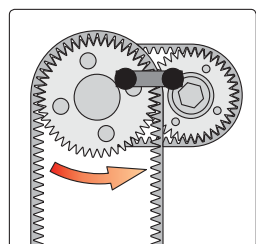

VW Lupo since 1999  
 Polo since 1995  
 VW Caddy since 1996  
 Polo Classic since 1996

Polo since 1996  
 New Beetle 1.4  
 Golf 1.4 1.6 since 1998  
 Bora 1.4 1.6 since 1999

YATO	Box
YT-0601	6/36

GB Diesel engine lock pin  
 D Blockade für die Steuerräder  
 PL Blokada do kół rozrządu  
 RUS Блокировка к колесам распределительных механизмов  
 CZ Souprava na fixaci rozvodových kol  
 H Diesel motor rögzítő készlet

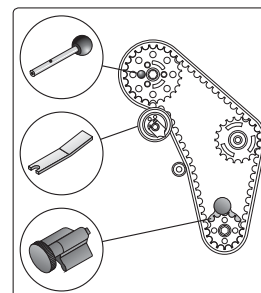

VW: Lupo, Polo, Golf / Bora, Beetle, Caddy, Sharan, Touran, Transporter (1998-2006);  
 AUDI: 2 3 4 6  
 FORD: Gaia (2000-2006)

RO Blocadă roțiilor distribuție  
 F Outil de blocage d'arbre à cames  
 I Cinghia di distribuzione di bloccaggio  
 E Bloqueo para las poleas del mecanismo de distribución  
 CN 正时皮带更换工具



SEAT: Arosa, Ibiza, Cordoba, Leon, Toledo, Alhambra (1999-2005);  
 SKODA: Fabia Octavia (2000-2006)  
 3i4c 12 14 19 TD PD  
 FORD: Gaia (2000-2006)  
 20 SD 20 TD PD

3 PCS

FOR VALVETRAIN DO UKLADU ROZRZADU

SLIDING CARD



YATO	Box
YT-0632	10/50

GB Timin ockin se  
D Arretierwerkzeugsatz für Nockenwellen  
PL Zestaw blokad rozrządu  
RUS Набор блокировок к колесам  
распределительных механизмов  
CZ Blokovací sada pro opravy rozvodů  
H Vezérműrögítő szerszámkészlet  
RO Set blocare distributie auto  
F Outil de blocage d'arbre à cames  
I Set di bloccaggio distribuzione auto  
E Juego de bloques de distribución  
CN 正时皮带固定器组套

3  
PCS

FOR VALVETRAIN  
DO UKŁADU  
ROZRZĄDU

FOR DIESEL  
ENGINES  
DO SILNIKÓW  
DIEŹLA

FOR GASOLINE  
ENGINES  
DO SILNIKÓW  
BENZYNOWYCH



**APPLICATION:**

**RENAULT:** Twingo, Clio, Kangoo, Megane, Scenic, Laguna, Espace 1.2, 1.4, 1.6, 1.8, 2.0 16v (98-06), 1.5dCi;  
**NISSAN:** Micra 1.5dCi, Kubistar 1.6 16v (03-06); **OPEL:** ivaro 2.0 16v (01-06)

**ZASTOSOWANIE:**

**RENAULT:** Twingo, Clio, Kangoo, Megane, Scenic, Laguna, Espace 1.2, 1.4, 1.6, 1.8, 2.0 16v (98-06), 1.5dCi;  
**NISSAN:** Micra 1.5dCi, Kubistar 1.6 16v (03-06); **OPEL:** ivaro 2.0 16v (01-06)

**ENGINE CODES:**

**RENAULT:** D4F, K4J, K4M, F4P F4R, F4Rt, F5R740, K9K  
**NISSAN:** K9K, K4M; **OPEL:** FR4 720

**SILNIKI O KODZIE:**

**RENAULT:** D4F, K4J, K4M, F4P F4R, F4Rt, F5R740, K9K  
**NISSAN:** K9K, K4M; **OPEL:** FR4 720

<b>YATO</b>	
YT-06014	10

BMC  
& COLOR  
SLEEVE



GB Timin ockin se  
D Arretierwerkzeugsatz für Nockenwellen  
PL Zestaw blokad rozrządu  
RUS Набор блокировок к колесам  
распределительных механизмов  
CZ Blokovací sada pro opravy rozvodů

H Vezérműrögítő szerszámkészlet  
RO Set blocare distributie auto  
F Outil de blocage d'arbre à cames  
I Set di bloccaggio distribuzione auto  
E Juego de bloques de distribución  
CN 正时皮带固定器组套

4  
PCS

FOR VALVETRAIN  
DO UKŁADU  
ROZRZĄDU

FOR GASOLINE  
ENGINES  
DO SILNIKÓW  
BENZYNOWYCH

DROP  
FORGED  
KUTE

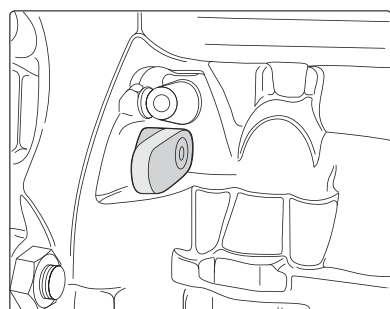
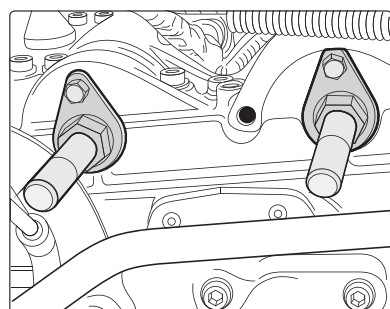

Timin ockin se for en ines 1.2 6 / 12 (chain)

Zestaw blokad rozrządu silników 1.2 6V / 12V (łańcuch)

**APPLICATION:**

**VW, SKODA, SEAT** 1.2 12V and 1.2 6V (HTP);  
**VW** Po o  
**SEAT:** Ibiza, Cordoba;  
**SKODA** Fabia HTP  
Engine codes AZQ, AWY, BMD, BME (02-07).

**ZASTOSOWANIE**

**VW, SKODA, SEAT** 1.2 12 i 1.2 6 (HTP)  
**VW** Po o  
**SEAT:** Ibiza, Cordoba;  
**SKODA** Fabia HTP  
Silniki o kodzie AZQ, AWY, BMD, BME (02-07).

**SET INCLUDES:**

- camshaft locking pin 1 pc
- crankshaft locking pin 1 pc
- camshaft locking clamps 2 pcs

**ZESTAW ZAWIERA:**

- trzpień blokujący wałek rozrządu 1 szt.
- trzpień blokujący wał korbowy 1 szt.
- zacisk blokujący wałki rozrządu 2 szt.



<b>YATO</b>	
YT-06012	20

GB Timin ockin se  
 D Arretierwerkzeugsatz für Nockenwellen  
 PL Zestaw blokad rozrządu  
 RUS Набор блокировок к колесам распределительных механизмов  
 CZ Blokovací sada pro opravy rozvodů  
 H Vezérműrgyítő szerszámkészlet  
 RO Set blocare distributie auto  
 F Outil de blocage d'arbre à cames  
 I Set di bloccaggio distribuzione auto  
 E Juego de bloques de distribución  
 CN 正时皮带固定器组套

**APPLICATION:**

**FIAT:** 500, Panda, Punto, Grande Punto, Albea, Linea, Bravo, Brava, Palio, Idea, Weekend, Siena, Stilo, Marea (97-10); **LANCIA:** Ypsilon, Musa (96-10)

**ENGINE CODES:**

1 2 16 - 176B9 000 182B2 000 188 5 000 1 4 16 - 843 1 000  
 169 3 000 192B2 000 198 1 000 198 4 000 199 6 000

**ZASTOSOWANIE:**

**FIAT:** 500, Panda, Punto, Grande Punto, Albea, Linea, Bravo, Brava Palio, Idea, Weekend, Siena, Stilo, Marea (97-10); **LANCIA:** Ypsilon, Musa (96-10)

**SILNIKI O KODZIE:**

1 2 16 - 176B9 000 182B2 000 188 5 000 1 4 16 - 843 1 000  
 169 3 000 192B2 000 198 1 000 198 4 000 199 6 000



5  
PCS

FOR VALVETRAIN  
DO UKŁADU  
ROZRZĄDU  
  
FOR GASOLINE  
ENGINES  
DO SILNIKÓW  
BENZYNOWYCH

BMC  
& COLOR  
SLEEVE

<b>YATO</b>	
YT-06016	10

GB Timin ockin se  
 D Arretierwerkzeugsatz für Nockenwellen  
 PL Zestaw blokad rozrządu  
 RUS Набор блокировок к колесам распределительных механизмов  
 CZ Blokovací sada pro opravy rozvodů  
 H Vezérműrgyítő szerszámkészlet  
 RO Set blocare distributie auto  
 F Outil de blocage d'arbre à cames  
 I Set di bloccaggio distribuzione auto  
 E Juego de bloques de distribución  
 CN 正时皮带固定器组套

**APPLICATION:**

**OPEL:** Astra, Vectra, Signum, Zafira, 1.9 CDTi (04 - 06);

**FIAT:** 1.9, 2.4 JTD; 16v, 20v;

**ALFA ROMEO:** 147, 156, GT 1.9 JTD 16v, 2.4 JTD 20v

**ENGINE CODES:**

**OPEL:** Z19DTH Z19DT

**ALFA ROMEO:** 192 5 000 192 B1 000 937 4 000 937 5 000

**ZASTOSOWANIE:**

**OPEL:** Astra, Vectra, Signum, Zafira, 1.9 CDTi (04 - 06);

**FIAT:** 1.9, 2.4 JTD; 16v, 20v.; **ALFA ROMEO:** 147, 156, GT 1.9 JTD 16v, 2.4 JTD 20v

**SILNIKI O KODZIE:**

**OPEL:** Z19DTH Z19DT **ALFA ROMEO:** 192 5 000 192 B1 000 937 4 000 937 5 000



6  
PCS

FOR VALVETRAIN  
DO UKŁADU  
ROZRZĄDU  
  
FOR DIESEL  
ENGINES  
DO SILNIKÓW  
DIELA

BMC  
& COLOR  
SLEEVE

<b>YATO</b>	
YT-06013	10

GB Timin ockin se  
 D Arretierwerkzeugsatz für Nockenwellen  
 PL Zestaw blokad rozrządu  
 RUS Набор блокировок к колесам распределительных механизмов  
 CZ Blokovací sada pro opravy rozvodů  
 H Vezérműrgyítő szerszámkészlet  
 RO Set blocare distributie auto  
 F Outil de blocage d'arbre à cames  
 I Set di bloccaggio distribuzione auto  
 E Juego de bloques de distribución  
 CN 正时皮带固定器组套



8  
PCS

AI

BMC  
& COLOR  
SLEEVE

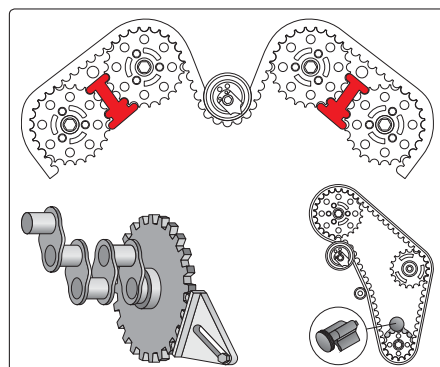

<b>YATO</b>	No.	No.		
YT-0633	Vauxhall/Opel: STR G 17TD STR G 20 16 CTR 1 820 16 1995	Volkswagen: BOR 19TD GO F 19TD UPO 1 2/1 4/3 0TD PO O 14TD P SS T 19TD	16	
	Vauxhall/Opel: STR G 14/1 6/1 8/16 1994 CTR 1 6/1 8/16 Z FR 1 6/1 8/16			
	right hand camshaft Saab: 900-9000 Vauxhall/Opel: C BR 2 5/2 5/2 6 6 C R 2 5 6 OM G B 2 5/2 6/3 0/3 2 6 S NTR 30 6 CTR 2 5/2 6 6			Citroen: B R NGO 19D DISPATCH 1.9D/TD-FSO 1.9D, RELAY 1.9D/TD, SYNERGIE 1.9/2.0T, SANTIAGA 1.9/2.0 D/TD/HDI, XSARA 1.9/2.0 D/HDI, ZX 1.9D/TD, most diesels Fiat: DUCATO 2.0D, ULYSSE 1.8/2.0 TURBO Ford: most diesels Peugeot: 205 1.6/1.8/1.9D 305 1.6/1.8/1.9D 306 1.8/1.9D/TD 309 1.6/1.9D-45 1.6/1.9D 406 1.9D 605 2.0D/TD 806 1.9D BOX R 1.9/2.0 D/TD XP RT 1.9D P RTN R 1.9D Talbot: EXPRESS D, HORIZON D-J5 D, SOLARA D
	left hand camshaft Saab: 900-9000 Vauxhall/Opel: C BR 2 5/2 5/2 6 6 C R 2 5 6 OM G B 2 5/2 6/3 0/3 2 6 S NTR 30 6 CTR 2 5/2 6 6			
	Rover: 25 1.4/1.6/1.8/ C 45 1.4/1.6/1.8 75 1.8 200 214 16 216 16 /C BR O/COUP 218 COUP 414 16 416 16 BRM 1.8 C			

- GB Timin ockin se for G  
D ins e werkzeu Zahnriemen nockenwe en  
Arretierwerkzeug steuerriemen für V.A.G.  
PL Zestaw blokad rozrządu dla V.A.G.  
RUS Набор блокировок  
газораспределения для V.A.G.  
CZ Sada aretacie rozvodov pro V.A.G.  
H Vezérműrögítő szerszámkészlet  
mer G  
RO Set blocare distributie auto pt. V.A.G.  
F Outil de blocage d'arbre à cames  
I Set di bloccaggio distribuzione auto  
E Juego de bloques  
de distribución para V.A.G.  
CN 大众&奥迪正时工具



34  
PCS

FOR / DLA  
V.A.G.

BMC  
& COLOR  
SLEEVE



<b>YATO</b>	
YT-06015	4

- GB Diesel injector puller  
D Stoßabziehvorrichtung für Einspritzdüse  
PL Ściągacz bezwładnościowy do wtryskiwaczy  
RUS Ударный съёмник форсунок  
CZ Rázový vytahovač vstříkovačů  
H Diesel porlasztó kisedő  
RO Dispozitiv de scoas injectoare  
F Extracteur à choc d'injecteurs  
I Mar e o scorrevo e  
per la rimozione degli iniettori  
E Tuerca ensora  
de impacto para inyectores  
CN 柴油喷嘴拔取器



**BOSCH**  
TYPE

**LUCAS**  
TYPE

M8  
M12  
M14

BMC  
& COLOR  
SLEEVE

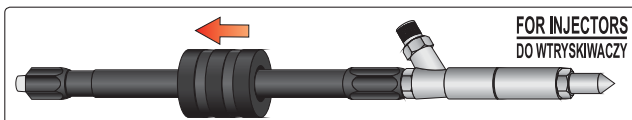

<b>YATO</b>	
YT-0617	20

- GB Overhead valve spring compressor  
D orrich un zur Demon a e von Mo orven i en  
PL Przyrząd do demontażu zaworów silnikowych  
RUS Устройство для демонтажа клапанов двигателя  
CZ Přípravek na demontáž ventilů motoru  
H Szeleplehúzó készülék  
RO Dispozitiv pt. demontarea supapelor la motoare  
F Outil pour démonter les soupapes de moteur  
I Strumento per la rimozione di valvole motore  
E Instrumento para desmontaje de válvulas de motor  
CN 下压式凡尔钳

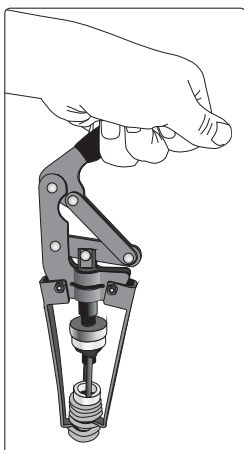

SLIDING  
CARD



16

<b>YATO</b>	
YT-0618	5/25

- GB Lambda sensor thread chaser
- D Lambdasonde gewinde reparatur-set
- PL Zestaw do naprawy gwintów sondy lambda
- RUS Набор для ремонта сорванной резьбы винтов
- CZ Sada na opravu závitu Lambda sondy
- H Menejavitó készlet Lambda szondához
- RO Dispozitiv pt. curatat filet sonda lambda
- F Set de réparation filetage de sonde lambda
- I Chiavi a bussola per sonda lambda
- E Cazador del hilo de rosca para sonda lambda
- CN 火星塞丝攻组套

FOR OXYGEN SENSOR DO SONDY LAMBDA

**HRC 50**

**M12 x 1.25**

**M18 x 1.5**



SLIDING CARD

<b>YATO</b>	
YT-1756	12/96

- GB Oxygen sensor crowfoot wrench
- D Schlüssel für die Lambdasonde
- PL Klucz do sondy lambda
- RUS Ключ для зонда lambda
- CZ Klíč na sondu lambda
- H Lambda szonda kulcs
- RO Cheie pt. sonda lambda
- F Clé pour sonde lambda
- I Chiave per sonde lambda
- E Llave para la sonda lambda
- CN 氧传感器套筒扳手



**22 mm**

FOR OXYGEN SENSOR DO SONDY LAMBDA

**CrMo SCM-440**

<b>YATO</b>	
YT-1753	30/60



**CrV 50BV30**

<b>YATO</b>	
YT-1754	6/36

- GB Socket and oxygen sensor set
- D Steckschlüssel für die Lambda-Sonde
- PL Klucze nasadowe do sondy lambda
- RUS Торцевые ключи с внутренним многогранником для зонда lambda
- CZ Nástrčné klíče na sondy lambda
- H Dugókulcs lambda szondához
- RO Prize pt. sonda lambda
- F Douille pour sonde lambda
- I Set di riparazione per filetti di sonda lambda
- E Llaves de cubo para la sonda lambda
- CN 氧传感器套筒扳手套组



**3 PCS**

**22 mm**

FOR OXYGEN SENSOR DO SONDY LAMBDA

**CrMo SCM-440**

**CrV 50BV30**



- 22 mm 50 mm 6PT CrMo SCM440
- 22 mm 30 mm 6PT CrMo SCM440
- 22 mm 80 mm 6PT Cr 50B 30

<b>YATO</b>	
YT-1752	20

- GB Oxygen sensor and fuel injectors wrench set
- D Steckschlüsselsatz für die Lambdasonde und die Einspritzdüsen
- PL Zestaw nasadek do sondy lambda i wtryskiwaczy
- RUS Набор насадок к лямбда-зондам и форсункам
- CZ Sada nástavců na demontáž sondy lambda a vstříkovačů
- H Dugókészlet lambda szondákhoz s in ek orokhoz
- RO Set inelare pt. sonda lambda și injectoare
- F Douilles pour sonde lambda et injecteurs
- I Set di riparazione per filetti di sonda lambda
- E Juego de boquillas para la sonda lambda y para inyectores
- CN 氧传感器套筒扳手套组



**7 PCS**

**1/2" 12.5mm**

**3/8" 10mm**

**CrMo SCM-440**

**CrV 50BV30**

FOR FUEL INJECTORS DO WTRYSKÓW PALIWA



- 1/2" (12.7 mm) 29 mm 90 mm 6PT
- 3/8" (9.5 mm) 22 mm 90 mm 6PT
- 1/2" (12.7 mm) 27 mm 78 mm 12PT
- 3/8" (9.5 mm) 27 mm 74 mm 6PT
- 3/8" (9.5 mm) 22 mm 80 mm 6PT
- 1/2" (12.7 mm) 22 mm 50 mm 6PT
- 3/8" (9.5 mm) 22 mm 30 mm 6PT

<b>YATO</b>	<b>size / rozmiar</b>	
YT-1751	1/2" (12.7 mm) 3/8" (9.5 mm)	5

BMC & COLOR SLEEVE



- GB Diese in ec ion socke se  
D Aufsätze für die Einspritzungen bei Dieselmotoren  
PL Zestaw nasadek do wtrysków w silnikach Diesla  
RUS Набор насадок к форсункам в дизельных двигателях  
CZ Sada nástavců na trysky dieselových motorů  
H Szerszámkészlet Dieselmotor befecskendezőkhöz  
RO Set de capete pt. injectoare în motoare Diesel  
F Set des douilles pour injecteurs (diesel)  
I Set di custodie per i motori diesel  
E Juego de tapones para las inyecciones en los motores de Diesel  
CN 柴油机燃油套筒组套



6 PCS 1/2" 12.5mm AS-DRIVE CrV

FOR FUEL INJECTORS  
DO WTRYSKÓW PALIWA



YATO	size / rozmiar	
YT-0622	1/2" (12.7 mm)	10

21 90 22 78 22 110 27 78 28 78 28 83 mm

- GB Diesel injector and cutter set  
D Fräsersatz für die Buchsen der Einspritzdüsen  
PL Zestaw frezów do gniazd wtryskiwaczy common rail  
RUS Комплект фрез для гнезд сопел форсунки  
CZ Sada fréz na sedla trysek vstříkovačů  
H Marókészlet befecskendező fúvókájának fészkehez  
RO Set de freze pt. socluri de duze injectoare  
F Alimentation d'un injecteur de common rail  
I Set frese per sedi iniettori common rail  
E Juego de fresas para el asiento de toberas de inyectoros  
CN 7件套气门较刀



7 PCS CrMoV SKD11

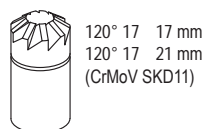
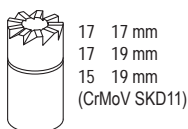
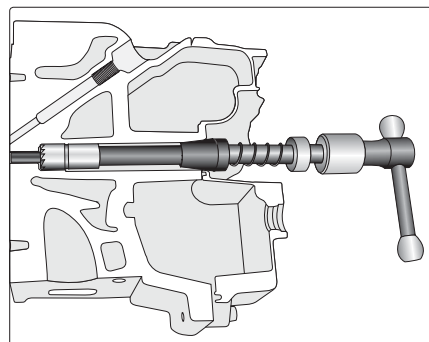

BMC & COLOR SLEEVE

YATO

YT-17625 10

16

- GB Too h socke for in ec ion nozz e  
D Stiftschlüsselsatz für die Einspritzdüse in Lastkraftwagen  
PL Zestaw kluczy czopowych do wtryskiwaczy w samochodach ciężarowych  
RUS Набор шиповых ключей к форсункам грузовых автомобилей  
CZ Sada klíčů na vstříkovače pro nákladní automobily  
H Csapokulcs készlet tehergépkocsik befecskendezőjéhez  
RO Set chei tubulare cu ungere pt. camioane  
F Set de douilles injecteurs  
I Set di chiavi per iniettori camion  
E Juego de llaves de muñon para os in ec ores en camiones  
CN 卡车喷油嘴套筒组套



4 PCS 1/2" 12.5mm HEX CrMo S45C CrV

FOR FUEL INJECTORS  
DO WTRYSKÓW PALIWA



YATO	size / rozmiar	
YT-1762	1/2" (12.7 mm)	16

- 1/2" (12.7 mm) 72 mm 4T Cr  
32 mm M14 15 mm 70 mm 4T S45C  
1/2" (12.7 mm) 120 mm 3T CrMo  
32 mm 120 mm 4T S45C

- GB Fuel injection test kit
- D Diagnosesatz für die Prüfung der Kraftstoffeinspritzung
- PL Zestaw diagnostyczny do wtrysku paliwa
- RUS Пневматический набор к тормозным зажимам
- CZ Souprava k diagnostice vstřikování paliva
- H Diagnosztikai készlet üzemanyag - befecskendőzökhoz
- RO Ansamblu pt. diagnosticarea injectiei combustibilului
- F Kit de test de débit d'injecteur
- I Set diagnostico per iniettori la benzina
- E Juego de herramientas diagnosticas para la inyección de combustible
- CN 燃料注射测试组套



10  
PCS  
P max.  
0.7 MPa

BMC  
& COLOR  
SLEEVE



**YATO**  
YT-0670 10

- GB Compression pressure gauge in a diesel engine
- D Kompressionsdruckmesser in Dieselmotoren
- PL Miernik ciśnienia sprężania w silnikach diesla
- RUS Измеритель давления компрессии в дизельных двигателях
- CZ Souprava k měření kompresních tlaků v dieselových motorech
- H Dieselmotorok kompresszióját mérő óra
- RO Manometrul presiunii aerului comprimat pt. motoarele diesel
- F Testeur de pression cylindrique diesel
- I Tester prova compressione motori diesel
- E Medidor de presión de la compresión en los motores diesel
- CN 柴油机压力测试组套



16  
PCS  
70 bar  
max.  
FOR DIESEL  
ENGINE  
DO SILNIKOW  
DIESLA

BMC  
& COLOR  
SLEEVE



**YATO**  
YT-7307 5

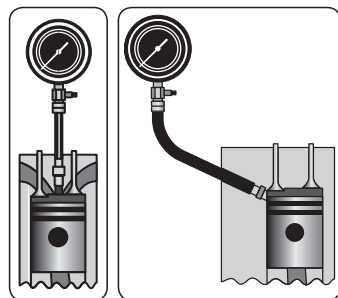

- 70 bar 500 mm
- 160 mm
- M20 1.5 75 mm M22 1.5 73 mm M24 1.5 88 mm M24 2 63 mm
- M10 1 83 91 102 113 119 mm M10 1 25 64 135 mm M12 1 25 47 mm M22 1.5 118 mm

16

- GB Oil pressure tester
- D Öldruckanzeige
- PL Miernik ciśnienia oleju
- RUS Тестер давления масла с адаптерами
- CZ Testér akového oleje
- H Olajnyomásmérő készlet
- RO Tester presiune ulei
- F Set de testeurs de pression d'huile
- I Tester misurazione pressione dell'olio
- E Manómetro de aceite
- CN 自动波箱压力表



12  
PCS  
185 cm  
HOSE  
WAZ  
FOR ALL TYPES  
OF ENGINES  
DO WSZYCH  
TYPOW SILNIKOW

0-35 bar 0-500 PSI

BMC  
& COLOR  
SLEEVE



**YATO**  
YT-73030 10

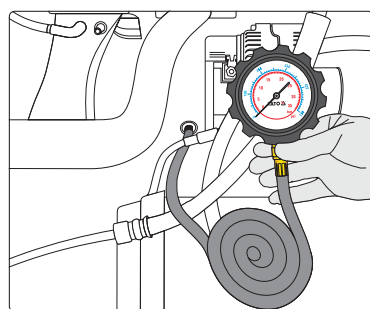



GB Compression tester  
D Druck uß mess era  
PL Miernik ciśnienia sprężania  
RUS Тестер компрессии

CZ Měřicí přístroj kompresního tlaku  
H Kompresszió mérő  
RO Aparat de măsurarea presiunii  
F Testeur de pression adaptateur cône

I Monometro pressione  
E Medidor de compresión  
CN 气缸压力表

**FOR ALL TYPES**  
DO WSZYSTKICH TYPÓW

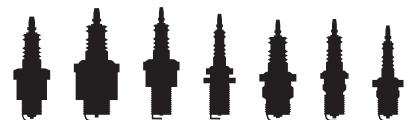

**21 bar max.**

FOR SPARK IGNITION  
DO ZAPALNI ISKROWEGO

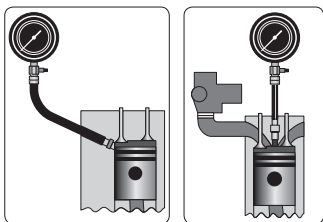

BMC & COLOR SLEEVE

RUBBER ADAPTOR ZŁĄCZE GUMOWE

COLOR BOX



THREADED ADAPTOR ZŁĄCZE GWINTOWANE

COLOR BOX



THREADED ADAPTOR ZŁĄCZE GWINTOWANE

RUBBER ADAPTOR ZŁĄCZE GUMOWE



<b>YATO</b>	
YT-7300	24/48

<b>YATO</b>	
YT-7301	12/24

<b>YATO</b>	
YT-7302	6/24

GB Flow meter common rail adapter set  
D Überlauf-Diagnosesatz für die Einspritzdüse Common rail  
PL Przelewowy zestaw diagnostyczny do wtryskiwaczy common rail  
RUS Диагностический набор к форсункам common rail; переливной  
CZ Souprava na diagnostiku vstřikovačů common rail, průtoková  
H Dia nosz ikai k sz e common rail injektorokhoz, átfolyós  
RO Set diagnostic preaplin pt. injectoare common rail  
F Kit de test de débit d'injecteur common rail  
I Set controllo portata iniettori common rail  
E Juego diagnóstico de flujo para inyectores common rail  
CN 柴油燃油喷嘴检测工具

**31 PCS**

FOR 6 CYLINDERS DO 6 CYLINDRÓW

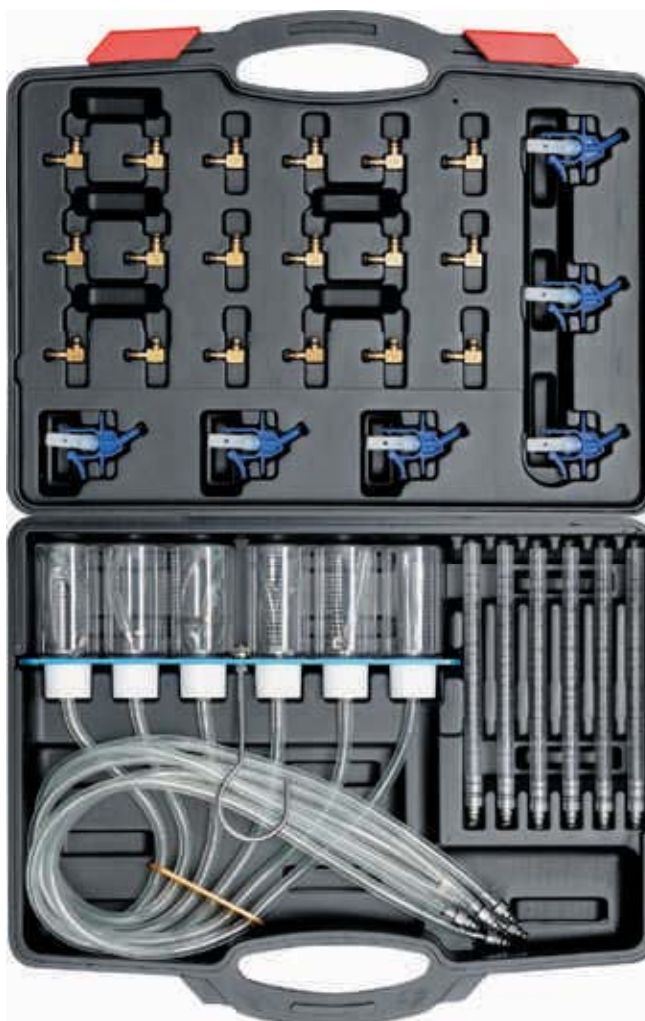

BMC & COLOR SLEEVE

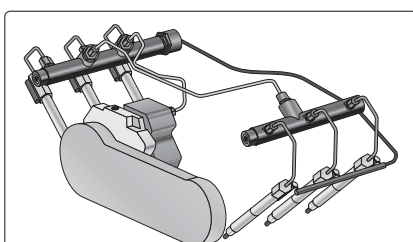

**DIESEL COMMON RAIL**

<b>YATO</b>	
YT-7306	5

GB Combined sockets for alternator  
 D Werkzeugsatz für Lichtmaschine  
 PL Zestaw do alternatorów ze sprzęgłem  
 RUS Набор для альтернатора  
 CZ Souprava na opravu alternátorů  
 H Generátor szerszámkészlet  
 RO Garnitură pt. alternator

F Set de clés à l'alternateur avec l'embrayage  
 I Set di chiavi per smontaggio puleggia e alternatore  
 E Enchufes combinados para alternador  
 CN 发动机拆卸组套

13 PCS	1/2" 12.5mm	HEX	TORX	SPLINE	CrV
		HRC 40-44	S45C	HRC 38-42	STEEL 8660
				HRC 53-57	

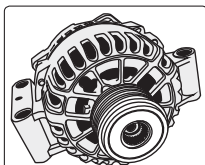

**FOR ALTERNATORS  
DO ALTERNATORÓW**

- □ □ □ □ 1/2" (12.7 mm) M10 HBS 33T 110 mm Cr HRC 40-44
- □ □ □ □ 1/2" (12.7 mm) T50 HBS 33T 110 mm Cr HRC 40-44
- □ □ □ □ M8 M10 75 mm 8660 HRC 53-57
- □ □ □ □ T40 T50 75 mm 8660 HRC 53-57
- □ □ □ □ H8 H10 75 mm 8660 HRC 53-57
- □ □ □ □ H15 33T 30 mm Cr HRC 40-44
- □ □ □ □ H22 33T 30 mm Cr HRC 40-44
- □ □ □ □ H22 30 mm S45C HRC 38-42
- □ □ □ □ 35 30 mm Cr HRC 40-44
- □ □ □ □ 1/2" (12.7 mm) 10 mm Cr HRC 40-44



<b>YATO</b>	○	☐
YT-0421	1/2" (12.7 mm)	15

GB Combined sockets for alternator  
 D Werkzeugsatz für Lichtmaschine  
 PL Zestaw do alternatorów ze sprzęgłem  
 RUS Набор для альтернатора  
 CZ Souprava na opravu alternátorů  
 H Generátor szerszámkészlet  
 RO Garnitură pt. alternator

F Set de clés à l'alternateur avec l'embrayage  
 I Set di chiavi per smontaggio puleggia e alternatore  
 E Enchufes combinados para alternador  
 CN 发动机拆卸组套

22 PCS	1/2" 12.5mm	HEX	TORX	SPLINE	CrV
		HRC 40-44	S45C	HRC 38-42	STEEL 8660
				HRC 53-57	

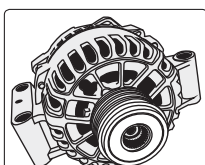

**FOR ALTERNATORS  
DO ALTERNATORÓW**

- □ □ □ □ 1/2" (12.7 mm) M10 HBS 33T 113 mm Cr HRC 40-44 / 8660 HRC 53-57
- □ □ □ □ 1/2" (12.7 mm) T50 HBS 33T 113 mm Cr HRC 40-44 / 8660 HRC 53-57
- □ □ □ □ 3/8" (10 mm) M10 HBS 33T 80 mm Cr HRC 40-44 / 8660 HRC 53-57
- □ □ □ □ 1/2" (12.5 mm) M10 HBS 33T 140 mm Cr HRC 40-44
- □ □ □ □ M8 M10 75 mm 8660 HRC 53-57
- □ □ □ □ T40 T50 75 mm 8660 HRC 53-57
- □ □ □ □ H8 H10 75 mm 8660 HRC 53-57
- □ □ □ □ M8 H12 64 mm 8660 HRC 53-57
- □ □ □ □ H15 33T 17 mm 30 mm H15 33T 19 mm 30 mm H22 33T 19 mm 30 mm Cr HRC 40-44
- □ □ □ □ H17 H22 30 mm S45C HRC 38-42
- □ □ □ □ 35 30 mm S45C HRC 38-42
- □ □ □ □ 38 mm S45C HRC 38-42
- □ □ □ □ H19 28 H21 28 H22 28 S45C HRC 38-42
- □ □ □ □ 1/2" (12.5 mm) (F) H10 mm (F) Cr HRC 40-44



<b>YATO</b>	○	○	☐
YT-04211	1/2" (12.7 mm)	3/8" (9.5 mm)	5

- GB Stroboscopic tube
- D Stroboskoplampe
- PL Lampa stroboskopowa
- RUS Стробоскопная лампа
- CZ Stroboskopická lampa
- H Stroboszkóp lámpa
- RO Lampă stroboscopică
- F Lampe stroboscopique
- I Lampada stroboscopica
- E Tubo estroboscópico
- CN 点火正时灯

12V

ENGINE SPEED  
最高转速  
8000 min<sup>-1</sup>  
max.

XENON

DOUBLE  
BLISTER

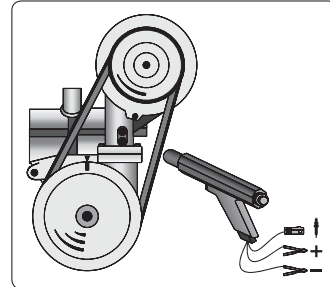

0-60°

**YATO**

YT-7310



6/12

**YATO**

YT-7311



6/12

**YATO**

YT-7312



6/12

- GB Universal radiator pressure kit
- D Diagnosekit für Kühler
- PL Zestaw diagnostyczny do chłodnicy
- RUS Диагностический набор к радиатору
- CZ Souprava k diagnostice chladiče
- H Diagnosztikai készlet hűtőkhöz

- RO Ansamblu pt. diagnosticarea radiatorului
- F Set diagnostique pour radiateur de voiture
- I Set universale tester pressione del radiatore para el radiador
- E Juego de herramientas diagnosticas para el radiador
- CN 万用水箱压力测试组套

14  
PCS

P max.  
0.25 MPa

200°C  
max.

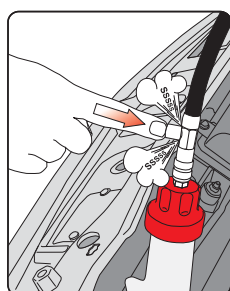
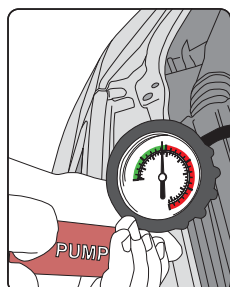
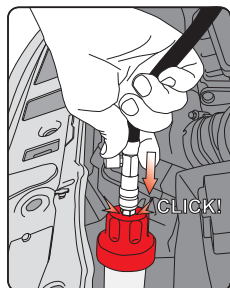

BMC  
& COLOR  
SLEEVE



16

YATO	No.		
YT-0672	2		General Motors
	3		Mercedes, General Motors, Jeep
	4		Peugeot, Subaru, Chrysler, General Motors, Mitsubishi, Nissan, Mazda, Toyota, Infiniti, GEO, Suzuki, Isuzu, Ford
	5		Honda, Toyota, Suzuki, Mitsubishi Chrysler
	6		Audi, BMW, Volkswagen, Porsche
	7		Volvo, Saab, Citroen, Renault, Fiat, Alfa Romeo, Jeep
	8		Skoda
	9		Mercedes, General Motors, Jeep
	10		BMW
	11		Audi, Volkswagen
	12		Ford, Land Rover, Opel, Jaguar, Mercedes
	13		Mercedes

- GB Hand-held vacuum pump
- D Unterdruckpumpe mit Zubehör
- PL Pompka podciśnieniowa z akcesoriami
- RUS Насос вакуумметрического давления с принадлежностями
- CZ Podtlaková pumpa s příslušenstvím
- H Vákuum- és ac-pumpa mérő, tartozékokkal
- RO Pompa de vidare cu accesorii
- F Pompe à vide avec les accessoires
- I Pompa a pressione con accessori
- E Bomba de subpresión con accesorios
- CN 手持式真空泵



**16**  
PCS **-1±0**  
bar

BMC  
& COLOR  
SLEEVE



**YATO**  
YT-0673 10

- GB Hand-held vacuum pump
- D Unterdruck-druckpumpe mit Zubehör
- PL Pompka ciśnieniowo-podciśnieniowa z akcesoriami
- RUS Насос вакуумметрического давления с принадлежностями
- CZ Podtlaková-tlaková pumpa s příslušenstvím
- H Vákuum- és ac-pumpa mérő, tartozékokkal
- RO Pompa de vidare cu accesorii
- F Pompe à vide avec les accessoires
- I Pompa a pressione con accessori
- E Bomba de subpresión-presión con accesorios
- CN 手持式真空泵



**22**  
PCS **-1±3**  
bar

BMC  
& COLOR  
SLEEVE



**YATO**  
YT-0674 5

16

- GB Flexible line clamp
- D Sch auchk emmensa z
- PL Komplet zacisków do przewodów z cieczą
- RUS Набор зажимов с фиксатором
- CZ Sada hadicových svěrek
- H Flexibilis cső elszorító készlet
- RO Clema flexibila
- F Set de pices pour serrer les
- I Set pinze per chiudere i
- E Juego de alicates apretadores para conductos de líquidos
- CN 油管封口钳组套

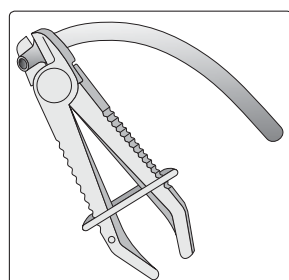

1/4" - 3/4"



1/2" - 5/4"



3/4" - 9/4"



1/4" - 3/4" for brake and fuel lines  
6.3 - 19.0 mm do przewodów hamulcowych i paliwowych

1/2" - 5/4" for flexible hose  
12.5 - 32.0 mm do przewodów elastycznych

3/4" - 9/4" for radiator hose clamp  
19.0 - 57.0 mm do przewodu chłodnicy

**3**  
PCS

WILL NOT  
CUT HOSES  
NIE NSZCZY  
PRZEWODÓW

NON-CONDUCTIVE  
NIEPRZEWODZĄCE



SLIDING  
CARD

**YATO**  
YT-0840 25/50

- GB Spark plug socket  
D Steckschlüssel  
mi Gummiha erun  
PL Nasadka do świec  
RUS Головка свечная  
CZ Nastavec pro svíčky  
H Gyújtógyertya toldalék  
RO Cheie de bujii  
F Douille à bougies  
I Chiavi a busso a  
E Boquilla de bujías  
CN 六角火花塞套筒

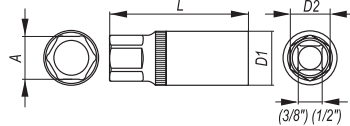

YATO	Ø	A	D1 (mm)	D2 (mm)	L (mm)	PCS packing:	
YT-3851	3/8" (9.5 mm)	16.0	22.0	19.0	64.0	10	50/100
YT-1253	1/2" (12.7 mm)	16.0	22.0	19.0	64.0	10	50/100
YT-1254	1/2" (12.7 mm)	21.0	27.8	24.0	64.0	10	50/100

- GB Spark plug socket  
D Kerzenschlüssel mit Verlängerungshebel  
PL Klucz do świec z przedłużką  
RUS Ключ к свечам с удлинителем

- CZ Klíč na svíčky s prodlužovacím nástavcem  
H Gyertyakulcs hosszabbítóval  
RO Cheie cu prelungitor, pt. bujii  
F Douille à bougies

- I Chiavi per candele a tubo  
E Llave para las bujías con extensión  
CN 火花塞套筒

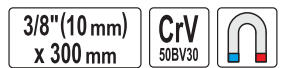

YATO	Ø (mm)	
YT-0817	16	10/40
YT-0818	18	10/40
YT-0819	21	10/40

- GB Bi-hexagonal spark plug socket  
D Zwölfkant-Kerzenschlüssel  
mi er an erun shebe  
PL Klucz do świec dwunastokątny z przedłużką  
RUS Ключ к свечам с удлинителем

- CZ Klíč dvanáctihřanný na svíčky  
s prodlužovacím nástavcem  
H Gyertyakulcs hosszabbítóval, 12 lapú  
RO Cheie cu prelungitor, bihexagonala, pt. bujii

- F Douille à bougies  
I Chiavi per candele a tubo  
E Llave bihexagonal para las bujías con extensión  
CN 十二角火花塞套筒



YATO	Ø (mm)	
YT-0812	14	10/40

- GB Joined glow plug socket set  
D Schlüsselsatz für Glühkerzen  
PL Zestaw kluczy do świec żarowych  
RUS Набор ключей к капильным свечам  
CZ Sada klíčů na žhavicí svíčky  
H G er aku cs k sz e  
RO Set chei pt. bujii incandescente  
F Set de douilles à bougies  
I Se chiavi a busso a snodate per candele  
E Juego de llaves para bujías incandescentes  
CN 预热火花塞套筒组套

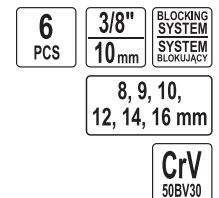

YATO	Ø	
YT-0534	3/8" (9.5 mm)	10

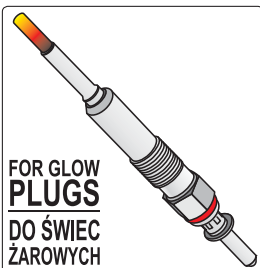

FOR GLOW PLUGS  
DO ŚWIEC ŻAROWYCH

BMC & COLOR SLEEVE



- GB Torque angle gauge  
D inke messer zum nziehen von Schrauben  
PL Kałomierz do dokręcania śrub  
RUS Угломер для подвёртывания болтов  
CZ Úhloměr k utahování šroubů  
H Nyomaték szögmérő  
RO Raportor pt. inşurubat şuruburi  
F Rapporteur à serrer les vis  
I Goniometro per il serraggio controllo  
E Calibrador para apretar tornillos  
CN 扭力角度规



YATO		
YT-0593		12/48

- |   |   |
|---|---|
| GB Metal conduit bender                     | RO Mașina de indoit (curbat) pt. cabluri metalice |
| D Biegevorrichtung für Metallleitungen      | F Cintreuse au câble de frein                     |
| PL Giętarka do przewodów metalowych         | I Piegatrice per fili metallici                   |
| RUS Гибочный станок для проводов из металла | E Dobladora de tubos de metal                     |
| CZ Ohýbačka kovových trubek                 | CN 弯管器  |
| H Hajlító fémvezetékekhez                   |   |

SLIDING CARD  **AI**



**125 mm** max.∅ **6 mm** 



**235 mm** max.∅ **12 mm** 

<b>YATO</b>	L (mm)	
YT-0813	125	24/96

<b>YATO</b>	L (mm)	
YT-0814	235	6/48

- |   |
|---|
| GB Universal clutch adjustment set                  |
| D Universal-set, um die Kupplungsscheibe einstellen |
| PL Zestaw do centrowania tarczy sprzęgłowej         |
| RUS Комплект для центровки дисков сцепления         |
| CZ Univerzální sada pro nastavení spojky disk       |
| H Kuplung központosító készlet                      |
| RO Trusa pt. centrare ambreiaje                     |
| F Centreur d'embrayage                              |
| I Set di centraggio frizione                        |
| E Herramienta alineación embrague                   |
| CN 燭磁動請每溟   |



**9 PCS**  
∅ mm **11-25**



BMC & COLOR SLEEVE

 11 15 16.5 17 19 20 20.5 25 mm

<b>YATO</b>	
YT-06311	20

- |  |  |
|--|--|
| GB Disc brake pad puller                           | H Fékbetét kieszedő                                |
| D Träge Abziehvorrichtung für die Bremsklötze      | RO Extractor de inertie pt. plăcuțele de frână     |
| PL Ściągacz bezwładnościowy do klocków hamulcowych | F Extracteur pour plaquettes de frein a inertie    |
| RUS Инерционный съемник тормозных колодок          | I Estrattore per dischi freno                      |
| CZ Pomůcka k vytahování brzdových deštiček         | E Desmontador de inercia para las zapatas de freno |
|  | CN 刹车盘扳手   |

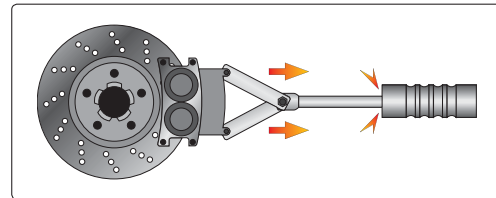

**DROP FORGED KUTE**  
**820g**  
**28-128 mm**



COLOR BOX

<b>YATO</b>	
YT-2538	20

- |   |  |
|---|--|
| GB Brake retainer spring tool           | F Extracteur de ressorts freins                  |
| D Montagewerkzeug für Bremsfeder        | I Freno scarpa di fissaggio a molla compressorii |
| PL Ściągacz sprężynek szcęk hamulcowych | E Herramienta para resorte retenedor de frenos   |
| RUS Съемник для тормозных пружин        | CN 刹车弹簧华司拆装器                                     |
| CZ Stahovač pružin brzdových čelistí    |  |
| H Fékrugó szerelő szerszám              |  |
| RO Dispozitiv pt. montat arc pe sabot   |  |

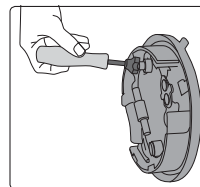

SLIDING CARD 

**FOR DRUM BRAKES DO HAMULCOW BIEDNOWYCH**



<b>YATO</b>	
YT-0685	12/96

<b>YATO</b>	
YT-0686	12/72

- |   |  |
|---|--|
| GB Brake spring pliers kit                  | RO Dispozitiv pt. inlocuit garnituri cilindrii receptori |
| D Bremsbacken-mo n a e se                   | F Set pour le montage des mâchoires de freins            |
| PL Zestaw do montażu szcęk hamulcowych      | I Set per montaggio molle freni                          |
| RUS Набор инструментов для тормозных пружин | E Juego para resortes de frenos                          |
| CZ Sada na montáž brzdových čelistí         | CN 刹车拆卸工具组套  |
| H Fogókészlet fékrugóhoz                    |  |

**3 PCS**

**FOR DRUM BRAKES DO HAMULCOW BIEDNOWYCH**

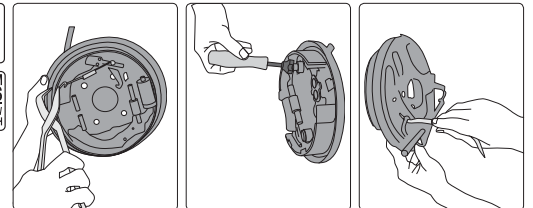

DOUBLE BLISTER 

<b>YATO</b>	
YT-0684	6/24

- GB Professional brake shoe set  
D Werkzeugsatz zum Wechseln der Bremsbacken  
PL Zestaw do wymiany szcęk hamulcowych  
RUS Набор для замены тормозных колодок  
CZ Sada na výměnu brzdových čelistí  
H Fékpofa-cserélő készlet  
RO Kit pt. înlocuirea saboților de frână  
F Set pour mâchoires de freins  
I Set di regolazione del freno  
E Juego para el reemplazo de zapatas de freno  
CN 刹车拆卸工具组套



8  
PCS

FOR DRUM  
BRAKES  
DO HAMULCOWY  
BĘBNOWYCH

BMC  
& COLOR  
SLEEVE



**YATO**  
YT-0680 5

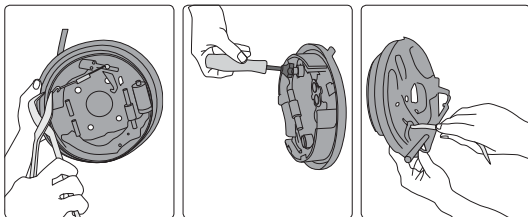

- GB Speedy brake pad compresses  
D Ausdrückvorrichtung für Bremskolben  
PL Wyciskacz do tłoczków hamulcowych  
RUS Приспособление для выдавливания тормозных поршней  
CZ Přípravek k zatlačování brzdových pístů  
H Fékdugattyú visszanyomó  
RO Presă pt. pistoane de frână  
F Repousse piston d'étrier de frein  
I Arretratore manuale per pistoncini freno  
E Expulsor para pistones de frenos  
CN 快速刹车片分离器



15-90  
mm

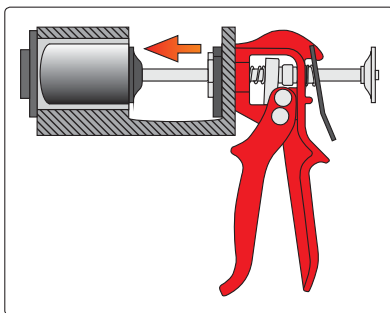

COLOR  
BOX



**YATO**  
YT-0604 16

- GB Disc brake spreader  
D Scheibenbremsen Abscheider  
PL Separator do hamulców  
arczow ch  
RUS Распорка тормозных дисков  
CZ Přípravek na montáž  
brzdových prasátek  
H Fékmunkahenger visszanyomó  
RO Separator disc ambreiaj  
F Séparateur des freins à disque  
I Separatore per pistoncini freno  
E Separador de frenos de discos  
CN 刹车片分离器

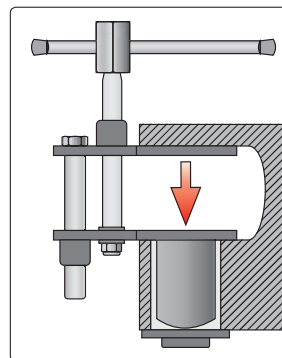

0-65  
mm 1/2" (12.5 mm)  
21 mm

COLOR BOX



**YATO**  
YT-0610 12/24

- GB Disc brake piston tool  
D Bremskolbenrücksteller universal  
PL Uniwersalny klucz do wkręcania  
zacisków hamulcowych  
RUS Ключ для тормозного поршня  
CZ Univerzální klíč  
k montáži brzdových třmenů  
H Féknyereg összenyomó

- RO Dispozitiv pt. impins etrier  
F Clé universelle pour pinces de frein  
I Attrezzo per l'arretramento  
della pinza dei freni  
E Llave para comprimir pistones  
del freno de disco  
CN 刹车分泵拆装器



for / dla: GM, FORD, Chrysler, VW, Fiat

3/8"  
10mm CrV

SLIDING  
CARD



**YATO**  
YT-0683 12/96

- GB Disc brake pad & caliper service tool kit
- D Werkzeugsatz von manuellen Separatoren für die Bremsklemmen
- PL Zestaw ręcznych separatorów do zacisków hamulcowych
- RUS Набор ручных сепараторов для тормозных зажимов
- CZ Ruční sada na montáž kotoučových brzd
- H Fékmunkahenger prés készlet
- RO Set de separatoare manuale pt. etrier frâna
- F Set de repousse piston de frein
- I Kit universale regolazione manuale per pistoni freni
- E Juego de separadores manuales para abrazaderas de freno
- CN 刹车片分离器组套

11  
PCS

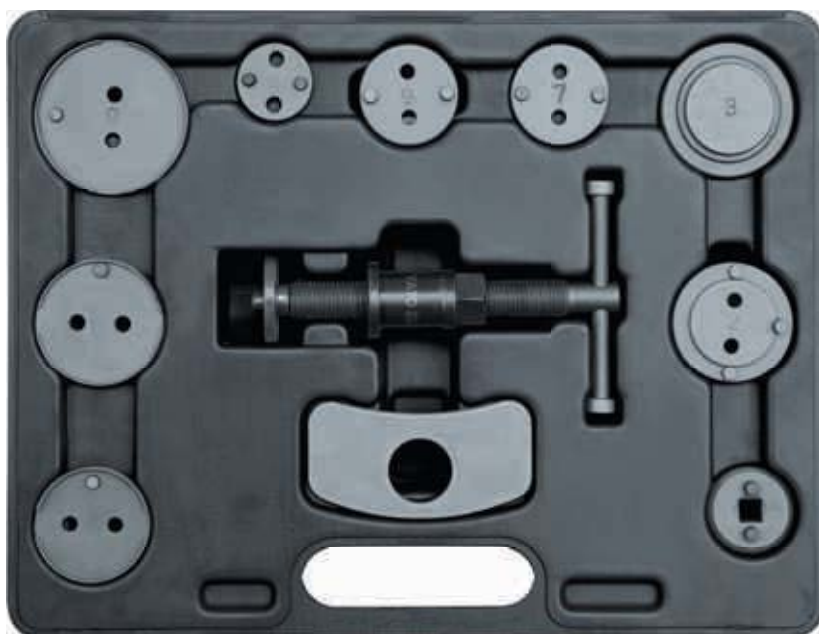

BMC  
& COLOR  
SLEEVE

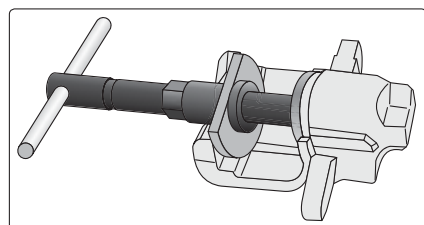

YATO	No.	zacisk przedni (F)	zacisk tylny (R)	
YT-0681	1-1	silownik		5
	1	plytka oporowa		
	5	adapter z gniazdem		
	2	Ci roen XM Xan ia		
	3	Alfa Romeo, Audi, Austin, BMW, Honda, Jaguar, MB, Mi subishi Nissan Rover To o a		
	4		Ford, Mazda, Subaru, Alfa Romeo, Saab	
	6		Nissan	
	7		Audi, Ford, Honda, Nissan, Rover, Saab, Subaru, VW	
	8	Genera Mo ors		
9	Genera Mo ors			

- GB Disc brake pad & caliper service tool kit
- D Werkzeugsatz von manuellen Separatoren für die Bremsklemmen
- PL Zestaw ręcznych separatorów do zacisków hamulcowych
- RUS Набор ручных сепараторов для тормозных зажимов
- CZ Ruční sada na montáž kotoučových brzd
- H Fékmunkahenger prés készlet
- RO Set de separatoare manuale pt. etrier frâna
- F Set de repousse piston de frein
- I Kit universale regolazione manuale per pistoni freni
- E Juego de separadores manuales para abrazaderas de freno
- CN 刹车片分离器组套

12  
PCS



BMC  
& COLOR  
SLEEVE

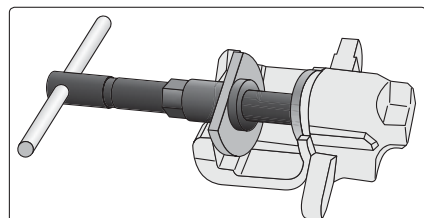

YATO	No.	zacisk przedni (F)	zacisk tylny (R)	
YT-0611	0	Genera Mo ors - zaciski 2 1/2" (63 5 mm)		10
	1	Adapter do przedniego zacisku		
	2	Ci roen XM Xan ia (F/R)		
	3		Opel (R)	
	4		Ford (R), Mazda (R), Saab (R), Alfa Romeo 164 2.0 (R), Honda (R), General Motors (R)	
	5	Nissan Ma ima		
	6		Nissan Primera Gof	
	7	Audi (F), Rover, Subaru (F), Ford (F), Nissan (F), Peu eo (F) To o a (F) (F)		
	8	Genera Mo ors - zaciski 1 7/8" (47 6 mm)		
	9	Genera Mo ors - zaciski 2 1/8" (54 0 mm)		
	11		Adapter do tylnego zacisku	



- GB Disk brake pad and caliper
- D Pneumatischer Werkzeugsatz für Bremssattelsysteme
- PL Pneumatyczny zestaw do zacisków hamulcowych
- RUS Пневматический набор к тормозным зажимам
- CZ Pneumatická souprava k montáži kotoučových brzd
- H Pneumatikus k szeftkormányok erekezhez
- RO Ansamblu pneumatic pt. cilindre de frana
- F Set pneumatique aux séparateurs de pinces de frein
- I Kit universale regolazione pneumatico per pistoni freni
- E Juego de herramientas neumaticas para apretadores de frenos
- CN 盘式制动衬块和制动钳

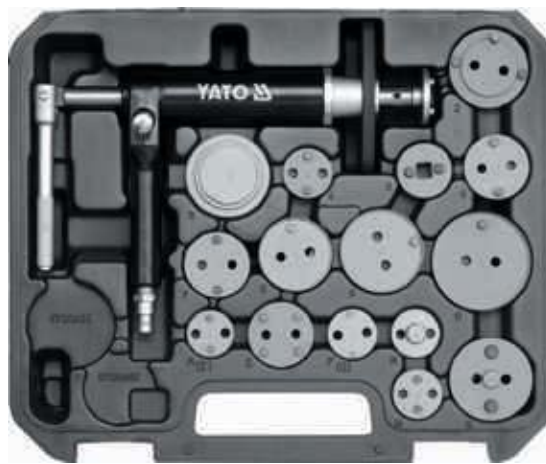
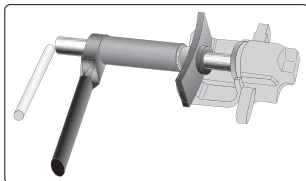

16  
PCS

0.75  
MPa

1/4"  
6.3mm

BMC  
& COLOR  
SLEEVE



YATO	No.	zacisk przedni (F)	zacisk tylny (R)
YT-0671	0	Genera Mo ors - zaciski 2 1/2" (F) (63.5 mm)	
	2		Ci roen XM Xan ia (F/R)
	3	Audi (F), Alfa Romeo (F), Fiat (F), Ford Fiesta (F), Isuzu (F), Honda Concerto (F), Jaguar (F/R), BMW (F), Mercedes-Benz (F) Mi subishi Co (F) Nissan mera S anza Sunn (F) Rover (F) To o a Camr (F) ovo (F) (F)	
	4		Ford (R), Mazda (R), Saab (R), Alfa Romeo 164 2.0 (R), Honda (R), General Motors (R)
	5		Adapter z gniazdem 3/8"
	6		Nissan Primera (R) Go f (R)
	7		Audi (R), Rover, Subaru (R), Ford (R), Nissan (R), Peugeot (R), Toyota (R), VW (R)
	8	Genera Mo ors - zaciski 1 7/8" (47.6 mm)	
	9	Genera Mo ors - zaciski 2 1/8" (54.0 mm)	
			Renau (R)
			Nissan Ma ima (F/R)
			Opel (R)
			Ci roen (R)
			Ford (R), Cooper (R)
		Saab, Honda (F/R)	

- GB Disc brake pad & caliper service tool kit
- D Werkzeugsatz von manuellen Separatoren für die Bremsklappen
- PL Zestaw ręcznych separatorów do zacisków hamulcowych
- RUS Набор ручных сепараторов для тормозных зажимов
- CZ Ruční sada na montáž kotoučových brzd
- H Fékmunkahenger prés készlet
- RO Set de separatoare manuale pt. etrier frâna
- F Set de repousse piston de frein
- I Kit universale regolazione manuale per pistoni freni
- E Juego de separadores manuales para abrazaderas de freno
- CN 刹车片分离器组套

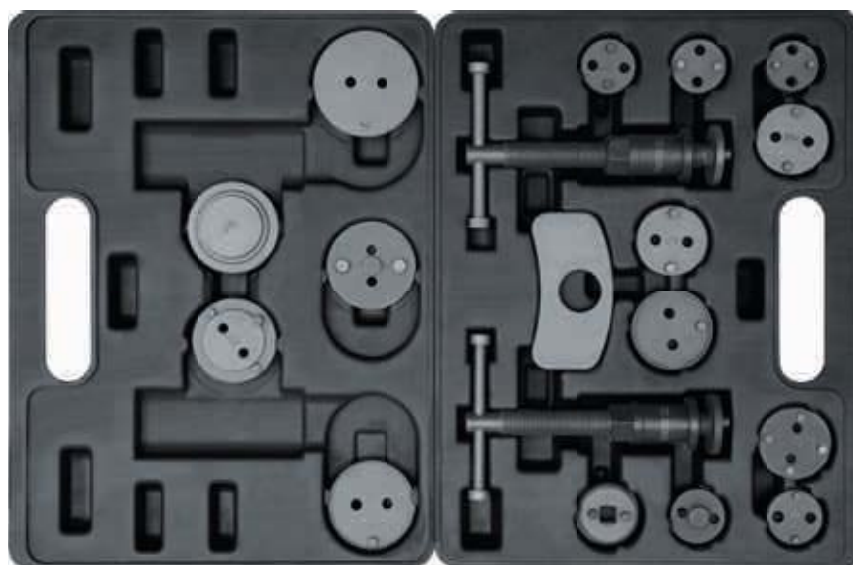
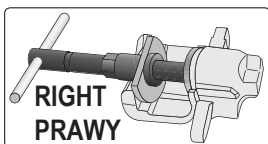
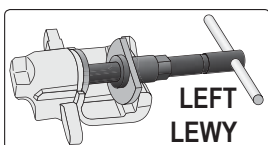

18  
PCS

BMC  
& COLOR  
SLEEVE



YATO	No.	zacisk tylny (R)	zacisk tylny (R)	
YT-0682	1-1		silowniki z lewym i prawym gwintem	
	1		plytka oporowa	
	5	3/8" (10.0 mm)	adapter z gniazdem	
	0	2 1/2" (63.5 mm)	Genera Mo ors	
	2	2 1/64" (51.0 mm)	Ci roen XM Xan ia	
	3	2 5/32" (55.0 mm)	Audi, Alfa Romeo, Fiat, Ford Fiesta, Honda, Jaguar, BMW, Mercedes, Mitsubishi Colt, Nissan, Rover us in To o a Camr ovo Passa Go f GT	
	4	1 1/4" (32.0 mm)	Ford, Mazda, Saab, Alfa Romeo 164, Honda, General Motors	
	6	1 21/32" (42.0 mm)	Nissan Primera Go f	
	7	1 21/32" (42.0 mm)	Audi, Rover, Subaru, Ford, Nissan, Peugeot, Toyota, VW	
	8	1 7/8" (48.0 mm)	Genera Mo ors	
	9	2 1/8" (54.0 mm)	General Motors, Cadillac	
			1 21/32" (42.0 mm)	Nissan Ma ima
			G 1 1/4" (32.0 mm)	Opel
			K 2 1/8" (54.0 mm)	Ci roen
			M 1 1/4" (32.0 mm)	Ford
			N 1 1/4" (32.0 mm)	Saab, Honda
		Z 1 3/16" (30.0 mm)	Renau	

- GB Disc brake pad & caliper service tool kit
- D Werkzeugsatz von manuellen Separatoren für die Bremsklappen
- PL Zestaw ręcznych separatorów do zacisków hamulcowych
- RUS Набор ручных сепараторов для тормозных зажимов
- CZ Ruční sada na montáž kotoučových brzd
- H Fékmunkahenger prés készlet
- RO Set de separatoare manuale pt. etrier frâna
- F Set de repousse piston de frein
- I Kit universale regolazione manuale per pistoni freni
- E Juego de separadores manuales para abrazaderas de freno
- CN 刹车片分离器组套

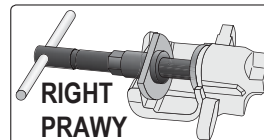
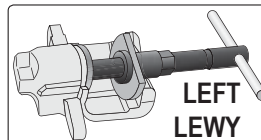

**35**  
PCS  
**3/8"**  
**10mm**

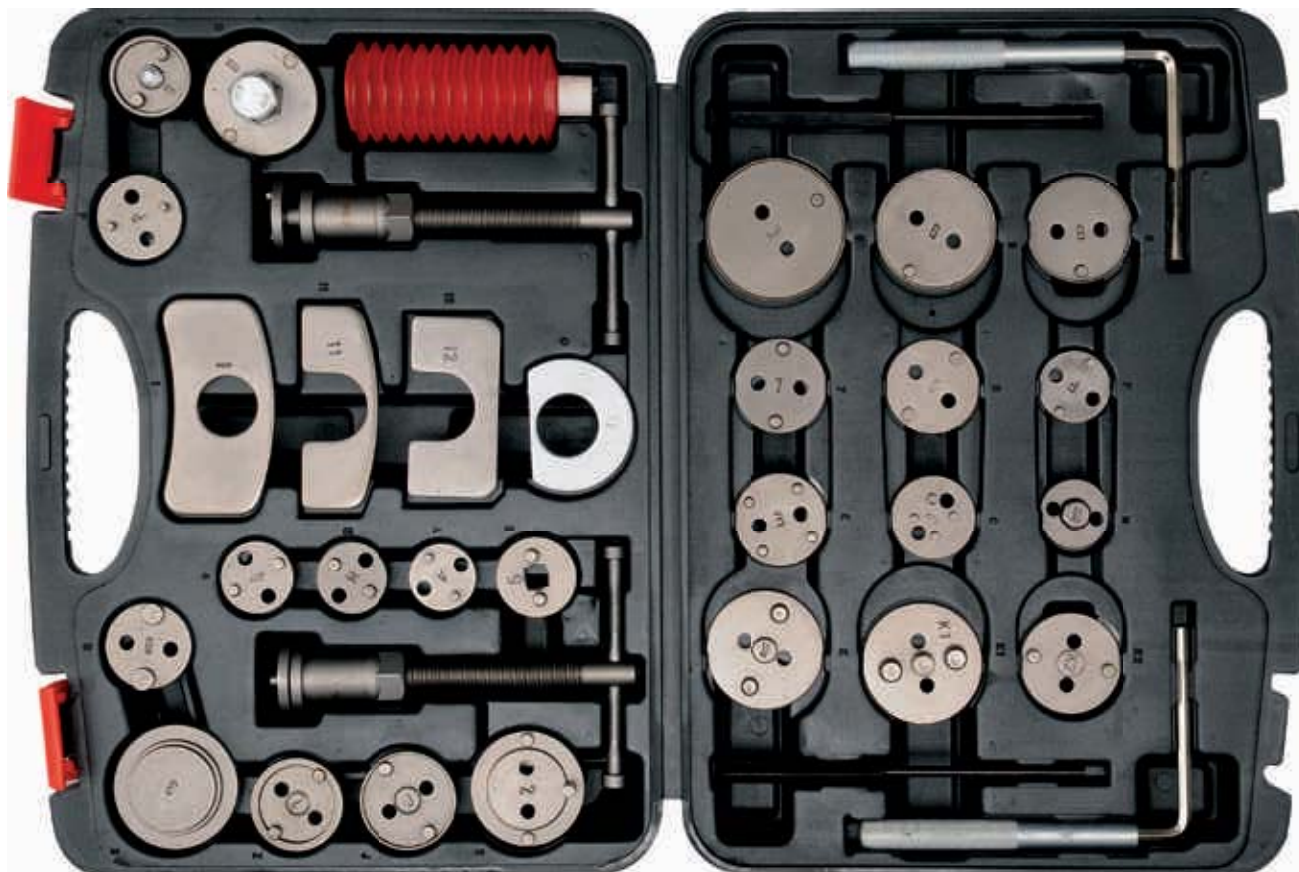

BMC & COLOR SLEEVE

No.	No.	zacisk przedni (F)	zacisk tylny (R)
	2	2 1/64" (51.0 mm)	Citroen Xantia, Honda Prelude
	3	2 5/32" (55.0 mm)	Fiat, Alfa Romeo, Isuzu, Mercedes Benz, BMW, Citroen, Ford, Honda, Jaguar, Nissan, Peuo Rover To o a G ovo Jaguar
	4	1 1/4" (32.0 mm)	Ford, Mazda, Saab, Fiat, Alfa Romeo, General Motors
	5	3/8" (10.0 mm)	adapter z gniazdem
	7	1 21/32" (42.0 mm)	Nissan, VAG, Jaguar S
	6	1 21/32" (42.0 mm)	Audi, Rover, Subaru, Ford, Nissan, Peugeot, Toyota, VAG, Saab, Jaguar, GM
	8	1 7/8" (48.0 mm)	Genera Mo ors
	9	2 1/8" (54.0 mm)	General Motors, Cadillac
	0	2 1/2" (63.5 mm)	Genera Mo ors
		1 1/5" (30.5 mm)	Renau BM Mini
YT-06822	B	1 19/30" (41.5 mm)	Ford, Lincoln, Subaru
	C	1 19/30" (41.5 mm)	Mini, Nissan, Opel, Toyota
	D	2 1/64" (51.0 mm)	Renau Ci roen
		1 21/32" (42.0 mm)	Nissan Ma ima
	F	1 1/4" (32.0 mm)	Opel, Fiat
	G	3/8" (10.0 mm)	Peuo GM
	J	1 22/33" (42.5 mm)	Fiat, Alfa Romeo, Audi, Citroen, Renault, Peugeot, Ford, Nissan, Saab, VAG, Subaru, Volvo
	K	2 1/8" (54.0 mm)	Citroen, Opel
	K1	2 1/8" (54.0 mm)	
	K2	1 22/23" (50.0 mm)	Citroen, Renault, Audi
	P	1 19/30" (41.5 mm)	VAG, BMW, Ford, Lancia, Proton, Renault, Rover, Citroen
	M	1 1/4" (32.0 mm)	Ford, Mini, Nissan
	N	1 1/4" (32.0 mm)	Saab, Honda, Alfa Romeo, Ford Mondeo, Lancia, Volkswagen
	Z	1 3/16" (30.0 mm)	Ford, Mazda, Mitsubishi, Toyota Corolla
	1 11 12		plytka oporowa

- GB Coil spring clamp  
D Federspanner  
PL Ściągacz do sprężyn  
RUS Съёмник пружин  
CZ Stahovák pružin  
tlumičů automobilů  
H Rugóösszehűző
- RO Presa pt. arcuri  
F Compresseurs  
de ressort  
I s ra ore  
per smonta molle  
E Extractor de muelles  
CN 弹簧夹



**2**  
PCS  
1/2" (12.5 mm)  
21 mm

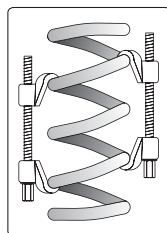

YATO	Ø (mm)	L (mm)	
YT-0605	90	200	5/10



CrV

YATO	Ø (mm)	L (mm)	
YT-2544	82	370	8

COLD FORGED KUTE NA ZIMNO

YATO	Ø (mm)	L (mm)	
YT-2546	82	280	8
YT-2547	82	355	8

- GB ice for shock absorber  
D Halterung, Schraubstock für die Säule von MacPherson  
PL Uchwyt, imadło do kolumny MacPhersona  
RUS Тиски к подвеске Макферсона  
CZ Uprínací přípravek, svěrák na nápravy McPherson  
H Fogantyú, satu MacPerson oszlophoz  
RO Mâner, menghină pt. coloana MacPerson  
F Poignée et étau pour la colonne MacPherson  
I Manico e vice co onne MacPherson  
E Mandril, torno para la columna de MacPherson  
CN 弹簧避震器固定器

35~70 mm



WHITE CARTON BOX & COLOR LABEL

YATO	
YT-2537	5

- GB Macpherson spring dumper extractor  
D Abziehvorrichtung für Federn von MacPherson  
PL Ściągacz do sprężyn MacPhersona  
RUS Съёмник пружин подвески Макферсона  
CZ Stahovák pružin McPherson  
H MacPerson rugó összehűző  
RO Extractor de arcuri MacPherson  
F Compresseurs de ressort MacPherson  
I Estrattore per molle MacPherson  
E Desmontador para los resortes de MacPherson  
CN 弹簧压缩器

CrMo SCM-415  
max. 2900kg

3 POINTS OF FIXING PUNKTY MOCOWANIA

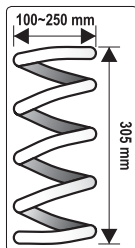

WHITE CARTON BOX & COLOR LABEL

YATO	
YT-2535	2

- GB Interchangeable fork spring compressor and removal tool  
D Abziehvorrichtung für MacPherson-Federn mi aus austauschbaren Halterungen  
PL Ściągacz do sprężyn MacPhersona z wymiennymi uchwytami  
RUS Стяжка для снятия пружин Макферсона со сменными полуколыцами  
CZ Stahovák pružin McPherson s vyměnitelnými čelistmi  
H MacPerson rugó összehűző cserélhető pókfalkal  
RO Ancoră suspensie MacPherson cu mâner interschimbabile  
F Compresseurs de ressort MacPherson  
I Smonta a molla a ori per sospensioni MacPherson  
E Extractor de resortes MacPherson con mandrillas intercambiables  
CN 免拆式减震弹簧压缩器



7 PCS  
65-125 mm  
88-160 mm  
max. 1500kg  
126-212 mm



BMC & COLOR SLEEVE

YATO	
YT-2536	1

GB Drive nut se  
 D Stossdämpfer Nutmutter Einsätze  
 PL Zestaw nasadek do amortyzatorów  
 RUS Набор головок для амортизаторов  
 CZ Sada hlavice na uložení tlumiče  
 H Lengéscsillapítókszedő szet  
 RO Set prezoane  
 F Set des embouts aux amortisseurs  
 I Set di chiavi per aria condizionata  
 E Juego de boquillas de amortiguadores  
 CN 拆装减震器套件组套

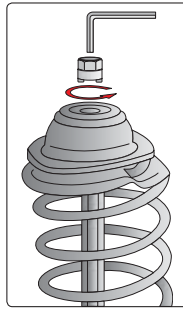

SLIDING CARD

YATO	size / rozmiar (mm)	
YT-0621	10 5 12 5 14 5 14 5 14 0	12/48

- No 1 10 5 mm Go f rear
- No 2 12 5 mm Go f fron
- No 3 14 5 mm VW Polo, Golf, Passat, Audi 80
- No 4 14 5 mm us in Maes ro
- No 5 14 0 mm Mercedes Benz C-Class (W203)

GB Turnbuckle for shock absorber's top lid  
 D Schlüsselsatz zum Befestigen der Stoßdämpfer  
 PL Zes awk uc z do mocowania amortyzatorów  
 RUS Набор ключей для крепления амортизаторов  
 CZ Sada klíčů k montáži tlumičů  
 H Kulcskészlet lengéscsillapítók rögzítéséhez

RO Set chei pt. fixare amortizoare  
 F Set de clés pour amortisseurs  
 I Set chiavi per montare ammortizzatori  
 E Juego de llaves para la instalación de amortiguadores  
 CN 避震器拆卸器

**39** PCS  
**CrMo** SCM415  
**CrV** 6140  
**CrV** 50BV30  
**STEEL** 8660

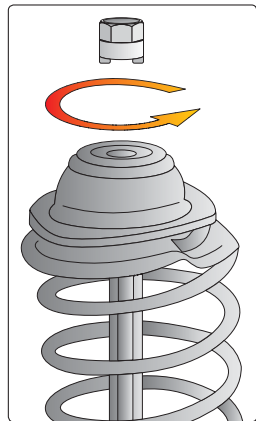

BMC & COLOR SLEEVE

YATO	size / rozmiar (mm)	type of car / model samochodu	size / rozmiar (mm)	type of car / model samochodu
YT-0628	10 5 3 5	Go f Rear e	D5	Nissan
	12 5 3 5	Go f Fron e	D10	Nissan, Ford
	14 5 5	VW Polo, Golf, Passat, Audi 80	8	Mercedes-Benz
	14 5 3	us in Maes ro	9	Opel/Vauxhall, Chrysler
	14 2 5	Mercedenz Benz W203 (C-class), W209 (CLK)	10	Chrysler, Ford
	14	Honda, Nissan	11	Japanese Cars
	16	VW, Audi, Seat, Fiat	5	Honda
	17	Ford, VW, Audi, Seat, Fiat	6	Seat, Fiat, Citroen, Peugeot, Ford, Opel, Renault, Japanese Cars, BMW
	18	Ford, VW, Audi, Seat, Rover, Fiat, Opel, Peugeot, Renault, Japanese Cars	7	VW, Audi, Seat, Fiat, Opel, Peugeot, Mercedes-Benz (W203), Renault
	19	VW, Audi, Seat, Citroen, Fiat, Opel, Peugeot, Toyota	8	Mercedes-Benz
	21	Mercedenz-Benz W203, Chrysler, VW, Audi, Ford, Japanese Cars	3	Mercedes-Benz, Opel, Renault
	22	VW, Audi, Seat, Citroen, Fiat, Opel, Peugeot, Renault, BMW	3 5	Chrysler, Ford, Citroen, Peugeot
	24	o vo	4	Ci roen Peu eo
	27	VW, Audi, Citroen, Peugeot	M12	Opel/Vauxhall
	4	Nissan	T50	Nissan, Ford
	5 2	VW, Audi, Nissan	T60	Ford
	6	VW, Audi, Renault		
	6 3	Nissan		
	7	VW, Audi, Seat, Fiat		
	8	Sea Fia		
9	Japanese Cars			
10	Sea Fia o vo			
12	Sea Fia			

GB Tire valve stem inser er  
 D Abziehvorrichtung für die Gummiventile  
 PL Przeciagacz do zaworków gumowych  
 RUS Протяжка к резиновым клапанам

CZ Páka k provlékání bezdušových ventilů  
 H Gumiszelep-metsző  
 RO Broșă pt. papapele cauciucate  
 F evier ire-va ve

I Brocca valvola di gomma  
 E Brocha de tracci3n para las v3lvulas de goma  
 CN 气门插入工具

SLIDING CARD

**290** mm

RUBBER VALVES ZAWORY GUMOWE



YATO	L (mm)	
YT-0619	290	12/72

GB Wheel balance pliers  
D Auswucht Zange mit Schutzkappe  
PL Szczypce do wyważania kół z osłoną  
RUS Клещи для балансировки колес с защитой для балансировки колес  
CZ Kleště pro vyvažování kol s ochranou  
H Centírsúly szerelő szerszám védőkupakkal  
RO Cleste pt. cauciuc

F Pincés pour le contrepois à agrafe de roue de voiture  
I Pinze per equilibrio ruota con protezione  
E Tenazas de equilibrar ruedas, con protector  
CN 平衡钳

SLIDING CARD

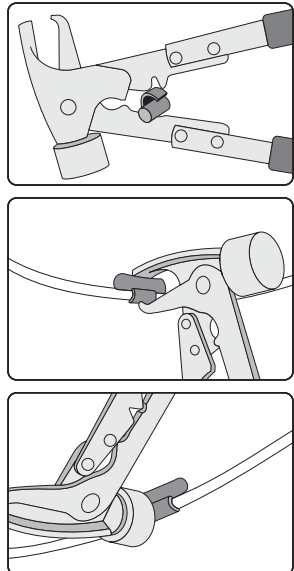

**YATO**  
YT-0643 12/48

GB Wheel balance pliers with cover  
D Auswuchtgewicht-Zange mit Schutzkappe  
PL Szczypce do wyważania kół z osłoną  
RUS Клещи с защитой для балансировки колес  
CZ Kleště pro vyvažování kol s ochranou  
H Centírsúly szerelő szerszám védőkupakkal  
RO Cleste pt. cauciuc cu protectie  
F Pincés pour le contrepois à agrafe de roue de voiture  
I Pinze per equilibrio ruota con protezione  
E Tenazas de equilibrar ruedas, con protector  
CN 平衡钳

SLIDING CARD



PROTECTION HEAD OSŁONA

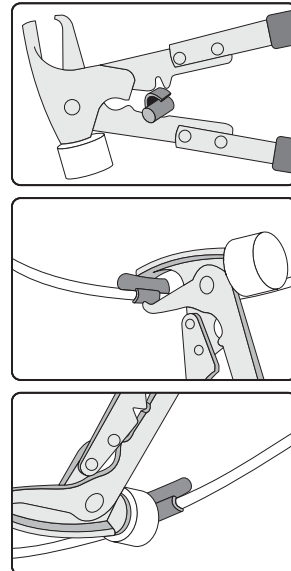

**YATO**  
YT-0644 6/48

GB Deep thin wall impact sockets  
D Schon-Kraftschraubereinsatz für Alufelgen  
PL Zestaw nasadek udarowych do felg aluminiowych  
RUS Набор головок для алюминиевых дисков  
CZ Sada nástrčných klíčů na alu ráčky  
H Hosszított dugókulcs készlet, könnyűfém felnihez  
RO Diblu de impact cu mufare in interior  
F Set de douilles profondes à choc  
I Set di chiavi a bussola per dadi ruota di alluminio  
E Juego de boquillas de percusión para llantas de aluminio  
CN 风动薄壁长套筒

- for use in ice stations and tire workshops
- for maximum impact loads
- drive locks
- ultra thin walls and nylon cover for working with aluminum rims
- anodized color finish for fast identification of size

- dla serwisów i warsztatów oponiarskich
- do największych obciążeń udarowych i tętniących
- zamki blokujące
- ultra cienkie ścianki i nylonowe pokrycie do pracy z felgami aluminiowymi
- anodowane kolorowe wykończenie dla szybkiej identyfikacji rozmiaru



3 PCS  
1/2" 12.5mm  
17 19 21 mm  
CrMo SCM-440  
26 29 31 mm  
AS-DRIVE

BMC & COLOR BOX



**YATO**  
YT-1056 1/2" (12.7 mm) 12/24

GB Rubber valve core torque tool  
D Drehmomentwerkzeug für Gummi Dichtende Reifventileinsätze  
PL Klucz dynamometryczny do zaworów gumowych  
RUS Ключ динамометрический для резиновых клапанов  
CZ Klíč momentový k montáži gumových ventilů  
H Szeleptűkiszerelő kulcs gumitömítésű szelephez  
RO Surubelnita din plastic pt. supapa  
F Clé dynamométrique pour soupapes  
I Giravite dinamometrica per valvole  
E Llave dinamométrica de válvulas de goma  
CN 定扭橡胶气门芯拆卸工具

SLIDING CARD

0.25 Nm

RUBBER VALVES ZAWORY GUMOWE

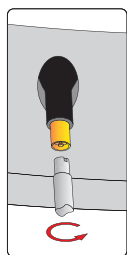

**YATO**  
YT-0795 50/200

GB Metal valve core torque tool  
D Drehmomentwerkzeug für metallisch Dichtende Reifventileinsätze  
PL Klucz dynamometryczny do zaworów metalowych  
RUS Ключ динамометрический для металлических клапанов  
CZ Klíč momentový k montáži kovových ventilů  
H Szeleptűkiszerelő kulcs fémtömítésű szelephez  
RO Surubelnita metalica pt. supapa  
F Clé dynamométrique pour soupapes  
I Giravite dinamometrica per valvole  
E Llave dinamométrica de válvulas de metal  
CN 定扭橡胶气门芯拆卸工具

SLIDING CARD

0.45 Nm

METAL VALVES ZAWORY METALOWE

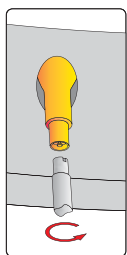

**YATO**  
YT-0796 50/200

- GB Cross rim wrench
- D Kreuzschlüssel
- PL Krzyżakowy klucz do kół
- RUS Ключ-крест балонный
- CZ Klíč na kola křížový
- H Kereszt kerékkulcs
- RO Cheie în cruce pt. roți
- F C en croi au roues
- I Chiavi a croce per auto ruota
- E Llave cruz para ruedas
- CN 十字套筒扳手



CrV



PLASTIC HANGER

YATO	size / rozmiar				
YT-0800	17	19	21	22 mm	10
YT-0801	17	19	21	1/2" (12.7 mm)	10
YT-0802	24	27	32	3/4" (19.0 mm)	3

- GB T-type sleeved ratchet wrench
- CZ Klíč na kola automobilů
- I Chiavi per ruota auto
- D Radmutter Schlüssel für Autos
- H Kerékkulcs
- E Llave para las ruedas de automóviles
- PL Klucz do kół samochodowych
- RO Cheie pt. roți de automobile
- CN T型棘轮扳手组套
- RUS Ключ к автомобильным колесам
- F Clé cliquet aux roues

4 PCS  
1/2"  
12.5mm  
44T  
CrV  
50BV30  
AS-DRIVE



PLASTIC HANGER

1/2" (12.7 mm) 17 19 21 23 mm

YATO	size / rozmiar	
YT-0803	17 19 21 23 mm	5/10

- GB reckon bar
- H Gumiabroncs kar
- E Desmontable para las llantas
- D Reifenmonierhebe
- RO Levier pt. roti
- CN 轮胎起子
- PL Łyżka do opon
- F Cuillère à pneus
- RUS Прибор для шиномонтажа
- I Leva per pneumatici
- CZ Montážní páka na pneumatiky

300 mm 400 mm 500 mm 600 mm CrV



YATO	size / rozmiar (mm)	
YT-0807	300	20
YT-0808	400	20
YT-0809	500	5/20
YT-0810	600	5/20

- GB Tire eve
- CZ Montážní páka na pneumatiky
- I Leva per pneumatici
- D Reifenmonierhebe
- H Gumiabroncs kar
- E Desmontable para las llantas
- PL Łyżka do opon
- RO Levier pt. roti
- CN 撬棒
- RUS Прибор для шиномонтажа
- F Cuillère à pneus

SLIDING CARD

380 mm CrMo



YATO	size / rozmiar (mm)	
YT-0811	380	10/50

- GB Extra long flexi shaft ratchet
- H Racsnis szár flexibilis hajtással
- I Albero flessibile con cricchetto
- D Ra sche auf bie samer e e
- RO Prelungitor flexibil pt. bormasina cu clichet
- E Árbol flexible con carraca
- PL Elastyczny walek z grzechotką
- F Cliquet élastique
- RUS Вороток к головке с трещоткой
- CN 加长定扭棘轮扳手
- CZ Ráčna s flexibilní rukojetí

HALF DOUBLE BLISTER

3/8" 10mm 400 mm 31 Nm  
1/4" (6.3 mm) 41T



YATO	size / rozmiar	
YT-0726	3/8" 10mm 400 mm	10/40

GB Rectangular telescopic inspection mirror  
D Teleskop Inspektionspiegel  
PL Lusterko inspekcyjne  
RUS Зеркало инспекционное телескопическое  
CZ Zrcátko kontrolní teleskopické  
H Vizsgáló tükör, teleszkópos nyéllel  
RO Oglinda telescopică pt. inspecție  
F Miroir d'inspection  
I Telescopio ispezione specchietto  
E Espejo rectangular telescópico de inspección  
CN 可伸缩矩形检测镜

50x90 mm  
TELESCOPIC HANDLE: 285x770 mm



**YATO**  
YT-0660 12/144

GB LED lighted telescopic inspection mirror  
D Prüfspiegel mit Beleuchtung  
PL Lusterko inspekcyjne z lampką  
RUS Зеркало досмотровое с подсветкой  
CZ Inspekční zrcadélko s lampou  
H Vizsgáló tükör, lámpával  
RO Oglindă pt. inspecție cu lampă  
F Miroir d'inspection avec lampe  
I Specchio di ispezione con lampada  
E Espejo de control con lámpara  
CN 带灯检测镜

265 - 920 mm; Ø54 mm  
TELESCOPIC HANDLE  
TELESKOPOWY UCHWYT  
LED  
STAINLESS STEEL  
STAL  
MERKWEZNYA



**YATO**  
YT-0663 10/100

GB Inspection camera  
D Inspektionskamera  
PL Kamera inspekcyjna  
RUS Контрольная камера  
CZ Inspekční kamera  
H Felügyelő kamera  
RO Cameră de inspecție  
F Camera d'inspection  
I Camera di ispezione  
E Cámara de inspección  
CN 手持式电子可视检查仪



BMC & COLOR SLEEVE  
900 mm  
60°  
12.2 mm  
LED CAMERA LIGHTING  
OSWIETLACIE KAMERY LED

9V (6LR61) BATTERY  
MATERIAŁ: ABS  
WYMIARY: 100x100x100 mm

LCD COLOR SCREEN  
320 x 240 QVGA  
KOLOROWY EKRAŃ LCD

**YATO**  
YT-7291 LCD TFT 2 4" (61 mm) 4



9V (6LR61) BATTERY  
MATERIAŁ: ABS  
WYMIARY: 100x100x100 mm

LCD COLOR SCREEN  
320 x 240 QVGA  
KOLOROWY EKRAŃ LCD

**YATO**  
YT-7290 LCD TFT 3 5" (89 mm) 4



LCD COLOR SCREEN  
320 x 240 QVGA  
KOLOROWY EKRAŃ LCD  
Wi-Fi  
3.7V LITHIUM BATTERY  
AKUMULATOR  
LiPolimer

**YATO**  
YT-7292 LCD TFT 3 5" (89 mm) 4

GB Telescopic magnetic pick up tool  
D Teleskop magnet Heber  
PL Chwytyk teleskopowy z magnesem  
RUS Захват магнитный телескопический

CZ Patka teleskopická magnetická  
H Felszedő mágnes, teleszkópos nyél  
RO Telescop magnetic  
F Capteur magnétique

I Telescopio magnete  
E Herramienta levantadora magnética, telescópica  
CN 可伸缩磁性捡拾器



**YATO**  
YT-0661 12/144

GB Telescopic magnetic pick up tool  
D Teleskop magnet Heber  
PL Chwytyk teleskopowy z magnesem  
RUS Захват магнитный телескопический

CZ Patka teleskopická magnetická  
H Felszedő mágnes, teleszkópos nyél  
RO Telescop magnetic  
F Capteur magnétique avec une diode

I Telescopio magnete  
E Herramienta levantadora magnética, telescópica  
CN 可伸缩磁性捡拾器

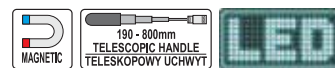

**YATO**  
YT-06611 12/144

GB Telescopic magnetic pick up tool  
D Teleskop magnet Heber  
PL Chwytyk teleskopowy z magnesem  
RUS Захват магнитный телескопический  
CZ Patka teleskopická magnetická  
H Felszedő mágnes, teleszkópos nyél  
RO Telescop magnetic  
F Capteur magnétique telescopique  
I Telescopio a specchio  
E Herramienta levantadora magnética, telescópica  
CN 可伸缩磁性捡拾器



**YATO** L (mm)  
YT-0860 59-99 6/24

GB Telescopic pick up and mirror set  
D Inspektionssatz: Spiegel + Greifer  
PL Zestaw inspekcyjny: lusterko + chwytyk  
RUS Проверочный набор + держатель и зеркальце  
CZ Inspekční souprava: zrcadlo + držák  
H Teleszkópos ellenőrző készlet: tükör + felvevő  
RO Garnitură de control: oglindă + benă  
F Kit miroir + grappin  
I Set per ispezione: specchio + supporto  
E Juego de inspección: espejo + cuchara de mordazas  
CN 检测镜捡拾器组套

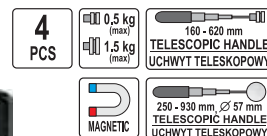

**YATO**  
YT-0662 10/40

GB Magnetic parts tray  
D Ma ne scha e  
PL Miska ma ne czna  
RUS Магнитный поднос  
CZ Miska magnetická

H Mágneses tálcá  
RO Tava ma ne ica  
F Bol magnétique  
I Cio o a ma ne ica

E Bandeja de accesorios ma n ica  
CN 磁盘



∅ mm  
110

**YATO**  
YT-08295 12/48



∅ mm  
150

**YATO**  
YT-0830 12/48



GB Magnetic parts tray  
D Ma ne scha e  
PL Miska ma ne czna  
RUS Магнитный поднос  
CZ Miska magnetická  
H Mágneses tálca  
RO Tava ma ne ica  
F Bol magnétique  
I Cio o a ma ne ica  
E Bandeja de accesorios ma n ica  
CN 磁盘



0,10-0,12 T (TESLA)

∅ mm 150



COLOR BOX



<b>YATO</b>	
YT-08305	20

GB Magnetic parts tray  
D Ma ne scha e  
PL Miska ma ne czna  
RUS Магнитный поднос  
CZ Miska magnetická  
H Mágneses tálca  
RO Tava ma ne ica  
F Bol magnétique  
I Cio o a ma ne ica  
E Bandeja de accesorios ma n ica  
CN 磁盘



COLOR BOX



350x150 mm



<b>YATO</b>	
YT-0831	6/12

GB Magnetic tool holder  
D Ma ne erkzeu ha er  
PL is wa ma ne czna  
RUS Магнитная рейка  
CZ Magnetický držák nářadí

H Mágneses tartó  
RO Suport magnetic  
F Barre et porte outil magnétique  
I S rscia ma ne ica

E Bandeja de accesorios ma n ica  
CN 磁性工具架



SLIDING CARD

<b>YATO</b>	
YT-0835	4/16

GB Tweezer  
D Pinze e  
PL Peřeta  
RUS Пинцет

CZ Pinze a  
H Csipesz  
RO Pensetă  
F Pince

I Pinza  
E Pinzas  
CN 镊子



140 mm HRC 30

SLIDING CARD



302 STAINLESS STEEL STAL NERDZEWNIA

ANTI MAGNETIC ANTYMAGNETYCZNA

ANTI ACID KWASO-ODPORNA

<b>YATO</b>	L (mm)	
YT-6903	140	20/480



115 mm HRC 30

<b>YATO</b>	L (mm)	
YT-6907	115	20/480



140 mm HRC 40

<b>YATO</b>	L (mm)	
YT-6916	140	20/480

GB Workshop creeper  
D erks a - ie e  
PL Leżanka warsztatowa  
RUS Лежак ремонтный  
CZ Lehátko  
H Fekpad gurulos  
RO Tar a  
F Chariot de visite  
I Lettino sdraio so ove ura  
E Camilla de taller  
CN 汽修躺板



100 cm



WHITE CARTON BOX & COLOR LABEL



<b>YATO</b>	
YT-0880	1

GB Workshop LED battery lamp  
 D LED Akku-handleuchte  
 PL Diodowa lampa warsztatowa akumulatorowa  
 RUS Аккумуляторный светодиодный светильник для мастерской  
 CZ Ruční svítidla LED  
 H Ledes szerelőlámpa címkéjű cikkek  
 RO Lampa portabila cu acumulator leduri  
 F Lampe baladeuse  
 I Lampada per officina spaccata  
 E in erna D recar ab e  
 CN 可充 衰 馱 鈇 腑

**1+1 LED** **180 lm**  
**3.7V 3600mAh Li-ion!** **230V~50Hz BATTERY CHARGER LADOWARKA**  
 CHARGING TIME: 4 h WORK TIME: 3 h / 2 LED  
 HOOK HAK MAGNETIC  
**LED**



**YATO** YT-08502 12



GB Workshop LED battery lamp  
 D LED Akku-handleuchte  
 PL Diodowa lampa warsztatowa akumulatorowa  
 RUS Аккумуляторный светодиодный светильник для мастерской  
 CZ Ruční svítidla LED  
 H Ledes szerelőlámpa címkéjű cikkek  
 RO Lampa portabila cu acumulator leduri  
 F Lampe néon  
 I Lampada neon  
 E in erna D recar ab e  
 CN 可充 衰 馱 鈇 腑

**3+1 LED** **250 lm**  
**2** **IP64**  
**3.7V 3600mAh Li-ion!** **230V~50Hz BATTERY CHARGER LADOWARKA**  
 CHARGING TIME: 4.5 h WORK TIME: 5 h / 3 LED  
 HOOK HAK MAGNETIC  
**LED**



**YATO** YT-08561 20



GB Workshop LED battery lamp  
 D LED Akku-handleuchte  
 PL Diodowa lampa warsztatowa akumulatorowa  
 RUS Аккумуляторный светодиодный светильник для мастерской  
 CZ Ruční svítidla LED  
 H Ledes szerelőlámpa címkéjű cikkek  
 RO Lampa portabila cu acumulator leduri  
 F Lampe d'inspection  
 I Torcia ispezione  
 E in erna D recar ab e  
 CN 可充 衰 馱 鈇 腑

**8 LED** **80 lm**  
**20 h** **1.5V 3x AAA**  
**LED**



**YATO** YT-08514 12/72



GB Workshop LED battery lamp  
 D LED Akku-handleuchte  
 PL Diodowa lampa warsztatowa akumulatorowa  
 RUS Аккумуляторный светодиодный светильник для мастерской  
 CZ Ruční svítidla LED  
 H Ledes szerelőlámpa címkéjű cikkek  
 RO Lampa portabila cu acumulator leduri  
 F Lampe baladeuse  
 I Lampada per officina spaccata  
 E in erna D recar ab e  
 CN 可充 衰 馱 鈇 腑

**8+1 LED** **280 lm** **3**  
**4 h** **1.5V 3x AA**  
**LED**



**YATO** YT-08513 50



GB Workshop LED battery lamp  
D LED Akku-handleuchte  
PL Diodowa lampa warsztatowa akumulatorowa  
RUS Аккумуляторный светодиодный светильник для мастерской  
CZ Ruční svítilna LED  
H Ledes szerezőlámpa címkéjű cikkek  
RO Lampa portabila cu acumulator leduri  
F Lampe baladeuse  
I Lampada led per autofficina  
E in erna D recar ab e  
CN 可充長款針腳



<b>27</b> LED	<b>13000</b> MCD	<b>3.6V</b> 1200mAh Ni-MH
230V~50Hz BATTERY CHARGER LADOWARKA	WATER PROOF ODPORNA NA WODE	CHARGING TIME CZAS LADOWANIA <b>4 h</b>
<b>4 h</b>	<b>4 h</b>	
<b>LED</b>		



**YATO**  
YT-08523 10



GB Workshop LED battery lamp  
D LED Akku-handleuchte  
PL Diodowa lampa warsztatowa akumulatorowa  
RUS Аккумуляторный светодиодный светильник для мастерской  
CZ Ruční svítilna LED  
H Ledes szerezőlámpa címkéjű cikkek  
RO Lampa portabila cu acumulator leduri  
F Lampe baladeuse  
I Lampada per officina spaccata  
E in erna D recar ab e  
CN 可充長款針腳



<b>30/7</b> LED	<b>13000</b> MCD	<b>3.6V</b> 1200mAh Ni-MH
230V~50Hz BATTERY CHARGER LADOWARKA	CHARGING TIME CZAS LADOWANIA <b>4-5 h</b>	WATER PROOF ODPORNA NA WODE
<b>15 h (7 LED)</b>	<b>4 h (30 LED)</b>	
<b>LED</b>		



**YATO**  
YT-08505 10



GB Rechargeable work lamp  
D Led Werkstattlampe  
PL Diodowa lampa warsz a owa  
RUS Светодиодная беспроводная лампа  
CZ Montážní lampa diodová bezpřívodová  
H Ledlámpa  
RO Lampa cu led fara cablu  
F Lampe baladeuse  
I Lampada led per autofficina  
E Lámpara inalámbrica de diodos  
CN 可充电工作灯



<b>4</b> LED	<b>400</b> lm	<b>IP65</b>
WIRE PREZEWOD 4.9 m	HOOK HAK	
<b>LED</b>		



**YATO**  
YT-08531 10

GB Rechargeable work lamp  
D Led Werkstattlampe  
PL Diodowa lampa warsz a owa  
RUS Светодиодная беспроводная лампа  
CZ Montážní lampa diodová bezpřívodová  
H Ledlámpa  
RO Lampa cu led fara cablu  
F Lampe baladeuse  
I Lampada led per autofficina  
E Lámpara inalámbrica de diodos  
CN 可充电工作灯



<b>60+1</b> LED	<b>13000</b> MCD	<b>7.2V</b> 800mAh Ni-MH
230V~50Hz BATTERY CHARGER LADOWARKA	WATER PROOF ODPORNA NA WODE	
<b>4 h</b>		
<b>LED</b>		



**YATO**  
YT-0852 5/20

GB Under bonnet work led lamp  
 D Led Werkstattlampe  
 PL Diodowa lampa warsztatowa do oświetlania komory silnika  
 RUS Светодиодная беспроводная лампа  
 CZ Montážní lampa diodová bezpřívodová

H Ledlámpa  
 RO Lampa cu led fara cablu  
 F Rampe d'éclairage  
 I Lampada led trasportabile per illuminazione di vani motore  
 E Lámpara inalámbrica de diodos  
 CN 引擎盖检修灯

<b>100 LED</b>	<b>600 lm</b>	<b>7.4V</b> 2000mAh <b>Li-Ion</b>
<b>230V~50Hz BATTERY CHARGER</b> ŁADOWNIKA	<b>CHARGING TIME</b> CZAS ŁADOWANIA <b>3-4 h</b>	<b>WORK TIME</b> CZAS PRACY <b>4 h</b> 100 LED
<b>HOOK HAK</b>	<b>MAGNETIC</b>	

**LED**



COLOR BOX

**YATO**

YT-08503 9

GB Under bonnet work led lamp  
 D Led Werkstattlampe  
 PL Diodowa lampa warsztatowa do oświetlania komory silnika  
 RUS Светодиодная беспроводная лампа  
 CZ Montážní lampa diodová bezpřívodová

H Ledlámpa  
 RO Lampa cu led fara cablu  
 F Rampe d'éclairage  
 I Lampada led trasportabile per illuminazione di vani motore  
 E Lámpara inalámbrica de diodos  
 CN 引擎盖检修灯



<b>120 LED</b>	<b>13000 MCD</b>	<b>60 LED</b>	<b>120 LED</b>
<b>7.2V</b> 1800mAh <b>NI-MH</b>	<b>230V~50Hz BATTERY CHARGER</b> ŁADOWNIKA	<b>WORK TIME</b> CZAS PRACY <b>8 h</b> 60 LED	<b>4 h</b> (120 LED)
<b>CHARGING TIME</b> CZAS ŁADOWANIA <b>4-5 h</b>	<b>HOOK HAK</b>		<b>MAGNETIC</b>

**LED**

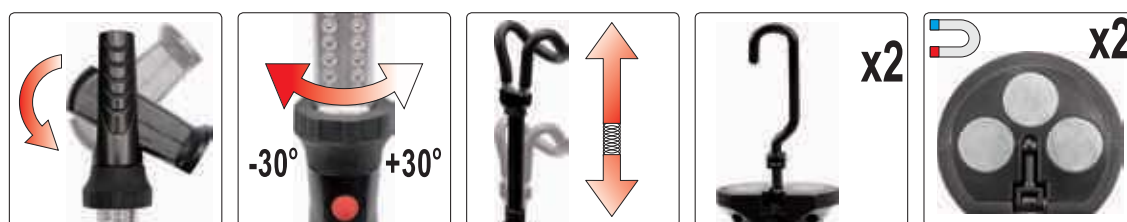

COLOR BOX

**YATO**

YT-08530 4

GB Disposable breathalyzer  
 D koho es er  
 PL Alkomat jednorazowy  
 RUS Алкотестер  
 CZ koho es er  
 H Alkoholszonda  
 RO coo me ru  
 F co es  
 I i ome ro monouso  
 E coho me ro  
 CN 酒精测试仪



PLASTIC BAG 30 PCS

DISPLAY COLOR BOX

**YATO**

YT-73310 900

- results in min
- accurac
- meets NF and T V standards
- user friendl
- not includes carcinogenic potassium dichromate
- with two plastic mouthpieces

- test w min
- dokładność 99%
- spełnia normy NF i TÜV
- prosty w obsłudze
- nie zawiera rakotwórczego dichromianu potasu
- z dwoma plastikowymi ustnikami

**YATO**

YT-73310 900

GB Universal circuit tester  
D KFZ Prüflampe  
PL Wskaźnik elektryczny samochodowy  
RUS Пробник напряжения автомобильный  
CZ Zkoušečka napětí autoelektrikářská  
H Próbálampa

RO Tester pt. circuite auto  
F Testeur de tension de voiture  
I Tester elettrico per auto  
E Indicador eléctrico de coche  
CN 汽车测电笔

SLIDING  
CARD



CABLE  
KABEL  
90 cm



6-24 V

6-12 V

<b>YATO</b>	
YT-2865	10/250

<b>YATO</b>	
YT-2866	10/100

GB Number stamp  
D Nummernstempel  
PL Znaczniki cyfrowe  
RUS Клейма цифровые  
CZ Razidla číselná  
H Számbeütők  
RO Poansoane cu cifre  
F Chiffres à frapper  
I Punzoni marca ori  
E Marcadores de números  
CN 数字冲模

9 PCS  
NUMBERS  
NUMERY  
0 - 9  
1045 CARBON  
STEEL  
HRC  
50-55



PLASTIC BOX  
& COLOR SLEEVE

GB Letter stamp  
D Buchstabenstempel  
PL Znaczniki i erowe  
RUS Клейма буквенные  
CZ Razidla písmenová  
H Betűbetűtők  
RO Poansoane cu i ere  
F Lettres à frapper  
I Punzoni marca ori  
E Marcadores de letras  
CN 字母冲模

27 PCS  
LETTERS  
LITERY  
A - Z &  
1045 CARBON  
STEEL  
HRC  
50-55



PLASTIC BOX  
& COLOR SLEEVE

<b>YATO</b>	No (mm)	PCS packing:	
YT-6854	6	9	20
YT-6855	8	9	18

<b>YATO</b>	No (mm)	PCS packing:	
YT-6862	6	27	12
YT-6863	8	27	8

GB Thread repair set  
D Reparatursatz für Gewinde  
PL Zestaw do naprawy gwintów  
RUS Набор для ремонта резьбы  
CZ Souprava na opravu závitů  
H Menetjavító készlet  
RO Set pt. reparare filete  
F Set d'helicoils  
I Kit di riparazione per filettature  
E Juego para reparar roscas  
CN 螺纹修复组套



METAL BOX  
& COLOR BOX

HSS  
4341  
STAINLESS  
STEEL  
STAL  
NIEOŻEWNA

88  
PCS

<b>YATO</b>	size / rozmiar	
YT-1769	M6 1.0 10.8 mm	5/10
	M8 1.25 10.8 mm	
	M10 1.5 13.5 mm	



131  
PCS

<b>YATO</b>	size / rozmiar	
YT-1763	M5 0.8 6.7 mm	5/10
	M6 1.0 10.8 mm	
	M8 1.25 10.8 mm	
	M10 1.5 13.5 mm	

GB Wire threads  
D Spiraleinlagen für Gewindereparatur  
PL Wkłady spiralne do naprawy gwintów  
RUS Метчики и сверла для ремонта резьбы  
CZ Spirálové vložky na opravu závitů  
H Menetjavító betétek

RO Insertii spirală pt. reparare filete  
F Hélicois  
I Inserti a spirale per riparazione  
E Elementos espirales para reparar roscas  
CN 不锈钢螺纹套

POLYBAG  
WITH  
HEADER



for / dla: YT-1763, YT-1769

STAINLESS  
STEEL  
STAL  
NIEOŻEWNA



<b>YATO</b>	size / rozmiar	PCS packing:	
YT-1764	M5 0.8 6.7 mm	20	50/250
YT-1765	M6 1.0 10.8 mm	20	50/250
YT-1766	M8 1.25 10.8 mm	20	50/200
YT-1767	M10 1.5 13.5 mm	15	25/100
YT-1768	M12 1.75 16.3 mm	10	25/100

- GB Dua foonire au e
- D Reifendruckprüfer
- PL Ciężniomierz do aut ciężarowych
- RUS Манометр для грузовых автомобилей
- CZ Tlakomer na nákladní auta
- H Nyomásmérő tehergépkocsikhoz
- RO Indicator de presiune pt. camioane
- F Manometre pneu pour camions
- I Manometro per automezzi
- E Manómetro de caomones
- CN 胎压表



SLIDING CARD



<b>YATO</b>	
YT-24301	25/100

- GB Foot pump with gauge
- D Fusspumpe
- PL Pompka nożna z manometrem
- RUS Насос ножный с манометром
- CZ Nožní pumpa z manometrem
- H Lábpumpa nyomásmérővel
- RO Pompă de picior cu manometru
- F Pompe à pied avec manomètre
- I Pompa a pedale con manometro
- E Bomba de pierna con manometro
- CN 打气筒



COLOR BOX



<b>YATO</b>	
YT-7349	10

- GB Foot pump with gauge
- D Fusspumpe
- PL Pompka nożna z manometrem
- RUS Насос ножный с манометром
- CZ Nožní pumpa z manometrem
- H Lábpumpa nyomásmérővel
- RO Pompă de picior cu manometru
- F Pompe à pied avec manomètre
- I Pompa a pedale con manometro
- E Bomba de pierna con manometro
- CN 打气筒



TWIN PISTON  
PODWÓJNY TŁOK



COLOR BOX



<b>YATO</b>	
YT-7350	10

- GB Hand pump with manometer
- D Hand-Luftpumpe mit Manometer
- PL Pompka słupkowa z manometrem
- RUS Насос ручной с манометром
- CZ Pumpa z manometrem
- H Kézi pumpa manométerrel
- RO Pompa de mana cu manometru
- F Pompe manuelle avec manomètre
- I Pompa verticale con manometro
- E Bomba de barrote con manometro
- CN 带压力表打气筒



PLASTIC HANGER & TAG CARD



<b>YATO</b>	
YT-7352	6

GB Funne  
D Trichter  
PL Lejek  
RUS Воронка гибкая  
CZ Nálevka  
H Kétrészes tölcsér  
RO Pâlnie  
Fentonnoir  
I mbu o  
E Embudo  
CN 漏斗



Ø  
**135mm**  
PP

YATO	Ø (mm)	
YT-0694	135	192

GB Long funnel  
D Trichter  
PL Lejek dlugi  
RUS Воронка гибкая  
CZ Nálevka  
H Kétrészes tölcsér  
RO Pâlnie  
Fentonnoir  
I mbu o  
E Embudo  
CN 漏斗



Ø  
**120mm**  
PP

YATO	L (mm)	Ø (mm)	
YT-0693	455	120	48

GB Operating fluids funnel  
D Trichter  
PL Lejek do płynów eksploatacyjnych  
RUS Воронка гибкая  
CZ Nálevka  
H Kétrészes tölcsér  
RO Pâlnie  
Fentonnoir  
I mbu o  
E Embudo  
CN 漏斗



Ø  
**100mm**  
PP

YATO	Ø (mm)	
YT-0695	100	180

GB Operating fluids funnel  
D Trichter  
PL Lejek do płynów eksploatacyjnych  
RUS Воронка гибкая  
CZ Nálevka  
H Kétrészes tölcsér  
RO Pâlnie  
Fentonnoir  
I mbu o  
E Embudo  
CN 漏斗



Ø  
**240mm**  
PP

YATO	Ø (mm)	
YT-0696	240	48

GB Fuel and oil funnel  
D Trichter  
PL Lejek do paliwa i oleju eksploatacyjnych  
RUS Воронка гибкая  
CZ Nálevka  
H Kétrészes tölcsér  
RO Pâlnie  
Fentonnoir pour essence et huile  
I mbu o  
E Embudo  
CN 漏斗



Ø  
**150mm**  
PP

YATO	Ø (mm)	
YT-0692	150	30

GB Oil funnel  
D Trichter  
PL Lejek do oleju  
RUS Воронка гибкая  
CZ Nálevka  
H Kétrészes tölcsér  
RO Pâlnie  
Fentonnoir  
I mbu o  
E Embudo  
CN 漏斗



Ø  
**280mm**  
PP

YATO	Ø (mm)	
YT-0697	280	48

GB Oil drain pan  
D Wanne  
PL Miska do oleju  
RUS Миска для масла  
CZ Miska na olej  
H Fărădtolaj felfogó edény  
RO Recipient pt. ulei  
F Bol à l'huile  
I Vaschetta per cambio olio  
E Escudilla para aceite  
CN 接油盆



PP

YATO	l	Ø (cm)	
YT-0699	8	37	48



PE

YATO	l	Ø (cm)	
YT-0716	10	37	6
YT-0717	15	42	4

GB Oil drainer  
D Ölefüllanlage  
PL Zlewarka do oleju  
RUS Устройство для слива масла  
CZ Olejová nádrž s odsáváním  
H Fărădtolaj leszívó  
RO Dispozitiv pt. schimbat ulei  
F Récupérateur d'huile  
I Scolapiatti dell'olio  
E Decantador para aceite  
CN 泄油器



75-155 cm PE

WHITE CARTON BOX & COLOR LABEL



YATO	l	Ø (cm)	
YT-0718	20	42	1

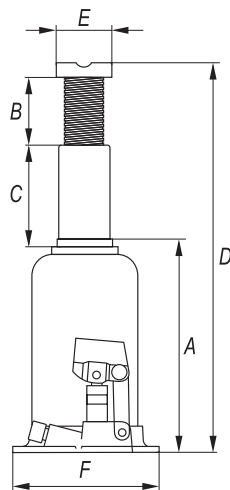

- GB Hydraulic bottle jack
- D Hydraulischer Stempelwagenheber
- PL Podnośnik hydrauliczny słupkowy
- RUS Домкрат гидравлический
- CZ Pístový zvedák hydraulický
- H Hidraulikus emelő
- RO Cric hidraulic
- F va eur
- I Cric idraulico a bottiglia
- E Gato de embolo hidr.
- CN 立式液压千斤顶



ELECTROLESS  
NICKEL  
PLATING

COLOR BOX





YATO 	T	A (mm)	(mm)	C (mm)	D (mm)	E (mm)	F (mm)	
YT-1702	5	212	110	146	468	40	110 112	5
YT-1704	10	220	115	148	483	48	124 127 5	3
YT-1706	15	231	113	154	498	56	140 142	2
YT-1707	20	241	115	165	521	60	165 161	2
YT-1709	30	244	108	140	492	65	186 174	1

- GB Two-piston hydraulic bottle jack
- D Hydraulischer Stempelwagenheber
- PL Podnośnik hydrauliczny słupkowy dwutłokowy
- RUS Домкрат гидравлический
- CZ Pístový zvedák hydraulický
- H Hidraulikus emelő
- RO Cric hidraulic
- F Elévateur deux niveaux
- I Cric idraulico a bottiglia
- E Gato de embolo hidr.
- CN 液压双级千斤顶





**5t**  
500  
↕  
220 mm

YATO 	T	
YT-1711	5	2



**10t**  
225  
↕  
125 mm

YATO 	T	
YT-1713	10	2

COLOR BOX





ELECTROLESS  
NICKEL  
PLATING

16





**10t**  
523  
↕  
208 mm

YATO 	T	
YT-1714	10	1



**12t**  
593  
↕  
230 mm

YATO 	T	
YT-1715	12	1



- GB Hydraulic floor jack
- D Hydraulischer Ran ierwa enheber
- PL Podnośnik hydrauliczny
- RUS Домкрат гидравлический
- CZ Pístový zvedák hydraulický
- H Hidraulikus emelő
- RO Cric tip crocodil
- F Elévateur hydraulique
- I Sollevatore idraulico
- E Gato de embolo hidr.
- CN 卧式液压千斤顶



LOW PROFILE



1.25t

375 mm  
↑  
80 mm

AI

COLOR BOX



<b>YATO</b> 	T	
YT-1719	1.25	1





2t

359 mm  
↑  
89 mm

BMC & COLOR SLEEVE



<b>YATO</b> 	T	
YT-1720	2	1





2.5t

457 mm  
↑  
89 mm

COLOR BOX



<b>YATO</b> 	T	
YT-1721	2.5	1

- GB Work bench
- D Lackierständer, verstellbar
- PL Stożak lakierniczy rozkładany
- RUS Раздвижная лакировочная стойка
- CZ Stojan lakýrnický rozkládací
- H Kinyitható lakkozó állvány

- RO Suport extensibil pt. lacuit
- F Support à peindre
- I Supporto pieghevole para barnizar
- CN 工作台

10 kg max  
85 cm

150 kg max  
45 cm



COLOR BOX

<b>YATO</b> 	
YT-5555	1

- GB Refractometer
- D Refraktometer
- PL Refraktometr
- RUS Рефрактометр
- CZ Refraktometr
- H Refraktorméter

- RO Refractometru
- F Refractometre
- I Rifrattometro
- E Refractómetro
- CN 冰点仪



PLASTIC BOX & COLOR SLEEVE

<b>YATO</b> 	
YT-06722	20

GB Electronic battery charger  
 D Elektronisches Ladegerät  
 PL Prostownik i ładowacz  
 RUS Электронное зарядное устройство  
 CZ Elektronická nabíječka  
 H Elektronikus akkumulátortöltő  
 RO Redresor electric  
 F Chargeur de batterie voiture  
 I Caricatore elettronico  
 E Rectificador electrónico  
 CN 蓄电池充电器



COLOR BOX



6 V	1 A
12 V	4 A
200 Ah max	230V~50Hz
WET GEL AGM	MOKRY ŻELOWY AGM
MICROPROCESSOR	

<b>YATO</b>	
YT-8300	8



230V~50Hz	5-160 Ah
2 A	12 V
8 A	
WET GEL AGM	MOKRY ŻELOWY AGM
MICROPROCESSOR	

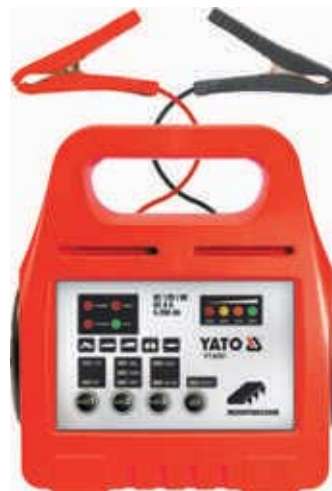

6 V	8 A
12 V	
5-200 Ah	230V~50Hz
WET GEL AGM	MOKRY ŻELOWY AGM
MICROPROCESSOR	

<b>YATO</b>	
YT-83016	12

<b>YATO</b>	
YT-8301	8

GB Electronic battery charger  
 D Elektronisches Ladegerät  
 PL Prostownik i ładowacz  
 RUS Электронное зарядное устройство  
 CZ Elektronická nabíječka

H Elektronikus akkumulátortöltő  
 RO Redresor electric  
 F Chargeur de batterie voiture  
 I Caricatore elettronico  
 E Rectificador electrónico  
 CN 蓄电池充电器

COLOR BOX



12 V	12 A
6-200 Ah	230V~50Hz
WET GEL AGM	MOKRY ŻELOWY AGM
MICROPROCESSOR	

<b>YATO</b>	
YT-8302	8



12 V	6-200 Ah
15 A	
230V~50Hz	WET GEL AGM
MOKRY ŻELOWY AGM	MICROPROCESSOR

<b>YATO</b>	
YT-8303	8

GB Ba er char er wi h a s ar er  
D Ladegerät mit starterfunktion  
PL Pro s ownik z rozruchem  
RUS Выпрямитель с функцией запуска  
CZ Nabíječka s funkci startování motoru  
H Akkumulátortöltő - indító  
RO Redresor cu pomire

F Chargeur de batterie  
voiture support demarrage  
I Caricabateria con avviamento  
E Rectificador con arranque  
CN 蓄电池充电器

COLOR  
BOX



230V~  
50Hz

12 V  
24 V



16 A

120-240  
Ah

WET  
MOKRY



25 A

170-350  
Ah

WET  
MOKRY

**YATO** 

YT-8304  2

**YATO** 

YT-8305  2



15 A

10-300  
Ah

WET  
MOKRY  
AGM

BOOST  
ROZRUCH  
12 V 75 A

 MICROPROCESSOR  
WIKIPROCESSOR



30 A

 MICROPROCESSOR  
WIKIPROCESSOR

50-600  
Ah

WET  
MOKRY  
AGM

BOOST  
ROZRUCH  
12 V 145 A

**YATO** 

YT-83051  2

**YATO** 

YT-83052  2

GB Ba er char er wi h a s ar er  
D Ladegerät mit starterfunktion  
PL Pro s ownik z rozruchem  
RUS Выпрямитель с функцией запуска  
CZ Nabíječka s funkci startování motoru  
H Akkumulátortöltő - indító

RO Redresor cu pomire  
F Chargeur de batterie  
voiture support demarrage  
I Caricabateria con avviamento  
E Rectificador con arranque  
CN 蓄电池充电器

GREY  
CARTON BOX  
& COLOR  
LABEL



230V~  
50Hz

WET  
MOKRY



12 V 27 A  
START/ROZRUCH  
300 A

24 V 25 A  
START/ROZRUCH  
240 A

20-600  
Ah



12 V 32 A  
START/ROZRUCH  
390 A

24 V 31 A  
START/ROZRUCH  
360 A

20-700  
Ah



12 V 38 A  
START/ROZRUCH  
540 A

24 V 35 A  
START/ROZRUCH  
450 A

20-800  
Ah

**YATO** 

YT-83060  1

**YATO** 

YT-83061  1

**YATO** 

YT-83062  1

GB Jumpstart wires  
 D Starke Kabel  
 PL Przewody rozruchowe  
 RUS Пусковые провода  
 CZ Staré kábel  
 H Indító kábelek

RO Cabluri demarare  
 F Câbles de démarrage  
 I Cavi carica batteria  
 E Cables de arranque  
 CN 输出线

WINDOW BAG WITH ZIPPER



2.5m



YATO	rated load / obciążenie nominalne ( )	
YT-83150	120	20
YT-83151	200	12

YATO	rated load / obciążenie nominalne ( )	
YT-83152	400	12

YATO	rated load / obciążenie nominalne ( )	
YT-83153	600	12

GB Analogue battery tester  
 D Analoges Batterieprüfgerät  
 PL Tester akumulatorów analogowy  
 RUS Аналоговый тестер аккумуляторов  
 CZ Analogový tester akumulátorů  
 H Analóg akkuteszter  
 RO Testeur de acumulatori analogic  
 F Testeur de charge batterie  
 I Tester analogico per batteria  
 E Tester analógico para acumuladores  
 CN 电池测试器

6V

12V

CCA 200-1000 A



COLOR BOX



YATO		
YT-8310		10

GB Digital battery tester  
 D Digitales Batterieprüfgerät  
 PL Tester akumulatorów cyfrowy  
 RUS Цифровой тестер аккумуляторов  
 CZ Digitální tester akumulátorů  
 H Digitális akkuteszter  
 RO Testeur de acumulatori digital  
 F Testeur digital de charge batterie  
 I Tester digitale per batteria  
 E Tester digital para acumuladores  
 CN 电池测试器

12V

LED DISPLAY

CCA 150-1400 A



COLOR BOX



YATO		
YT-8311		10

GB Battery tester  
 D Batterieprüfgerät  
 PL Tester akumulatorów  
 RUS Тестер аккумуляторов  
 CZ Tester akumulátorů  
 H Akku teszter  
 RO Testeur de acumulatori  
 F Testeur électronique de charge batterie  
 I Tester per batteria  
 E Tester para acumuladores  
 CN 电池测试器

12V

BATTERY TEST TEST AKUMULATORA

ALTERNATOR TEST TEST ALTERNATORA



DOUBLE BLISTER



YATO		
YT-83101		12/72

GB Chain block  
D Kettenzug Flaschenzug  
PL Wyciągarka łańcuchowa  
RUS Таль цепная  
CZ Zvedák řetězový  
H Lánco csigaszor emelő  
RO Scripete cu lant  
F Treuil à chaîne  
I Paranco a catena  
E Cabría de cadena  
CN 手拉葫芦

COLOR BOX



3m



<b>YATO</b>			<b>YATO</b>		
YT-5890	1	500 kg	YT-5893	1	2000 kg
<b>YATO</b>			<b>YATO</b>		
YT-5892	1	1000 kg	YT-5894	1	3000 kg

GB Electric hoist  
D Elektro-Seilwinde  
PL Elektryczny wciągnik linowy  
RUS Электрическая канатная лебёдка  
CZ Elektrický naviják kladkostroj  
H Elektromos csőrőlő  
RO Troiu electric cu cablu  
F Treuil électrique à corde  
I Cabria elettrica de cuerdas  
E Cabria eléctrica de cuerdas  
CN 电动葫芦

COLOR BOX



~230V  
50Hz

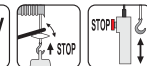

<b>YATO</b>				<b>YATO</b>			
500 W		125 kg	250 kg	900 W		250 kg	500 kg
<b>YATO</b>				<b>YATO</b>			
YT-5901	2	8 m/min max. 11m 125 kg	4 m/min max. 5.5m 250 kg	YT-5904	2	8 m/min max. 11m 250 kg	4 m/min max. 5.5m 500 kg
<b>YATO</b>				<b>YATO</b>			
550 W		150 kg	300 kg	1050 W		300 kg	600 kg
<b>YATO</b>				<b>YATO</b>			
YT-5902	2	8 m/min max. 11m 150 kg	4 m/min max. 5.5m 300 kg	YT-5905	2	8 m/min max. 11m 300 kg	4 m/min max. 5.5m 600 kg

GB Rope winch  
D Handseilwinde  
PL Wyciągarka linowa  
RUS Канатная лебёдка  
CZ Lanové vyťahovací zařízení  
H Drótköteles csőrőlő  
RO Troiu cu cablu orizontal  
F Treuil à corde  
I Paranco a corda  
E Cabría de cuerdas  
CN 绳索拉紧器

COLOR BOX



1000 daN

<b>YATO</b>	daN	L (m)	∅ (mm)	
YT-5911	1000	3	5	6



1300 daN

<b>YATO</b>	daN	L (m)	∅ (mm)	
YT-5913	1300	3	5	6



1500 daN

<b>YATO</b>	daN	L (m)	∅ (mm)	
YT-5914	1500	3	6	3

GB Shop crane  
 D Werks a kran  
 PL Żuraw warsztatowy  
 RUS Кран подкатной гидравлический  
 CZ Hydraulický jeřáb

H Motorkiemelő zsráf  
 RO Girafa pt. scos motor  
 F Grue d'atelier  
 I Gru idraulica

E Grúa hidráulica para motores  
 CN 吊机

GREY CARTON BOX  
 & COLOR LABEL

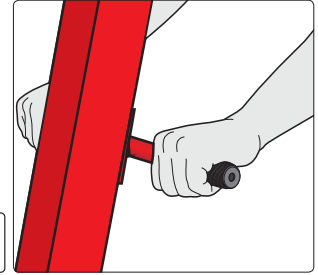

**600**  
kg



**YATO**  
YT-55560



1

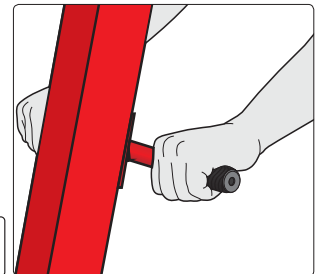

**1000**  
kg



**YATO**  
YT-55561



1

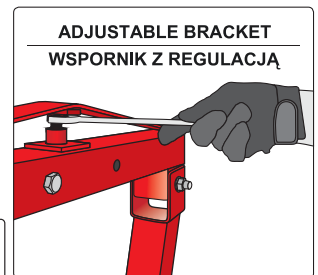

ADJUSTABLE BRACKET  
 WSPORNIK Z REGULACJĄ

**2000**  
kg



**YATO**  
YT-55562



1

GB Shop press  
D Hydraulische Werkstattpresse  
PL Prasa hydrauliczna  
RUS Гидравлический пресс

CZ Hydraulický lis  
H Hidraulikus prés  
RO Prasa hidraulică  
F Presse hydraulique

I Pressa idraulica  
E Prensa de hidráulica  
CN 压力机



**12t**

0-695 mm

400 mm



**20t**

0-695 mm

490 mm



**30t**

0-795 mm

520 mm

**YATO**    
YT-55580 1

**YATO**    
YT-55581 1

**YATO**    
YT-55582 1

GB Crane crossbeam  
D Traverse zum Kran  
PL Trawers do żurawia  
RUS Траверса для крана  
CZ Jeřábová traverza  
H Traverz a zsiráf emelőhöz

RO Traversă pt. macara  
F Balancier pour grue d'atelier  
I Traverser per gru  
E Viga transversal para grua  
CN 平衡器

**680 kg**   
**315 mm**

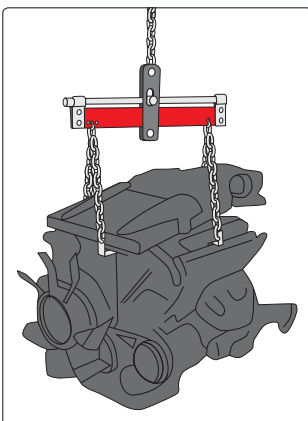

**YATO**    
YT-55565 1

GB Engine suspension beam  
D Aufnahmevorrichtung des Motors  
PL Belka do podwieszenia silnika  
RUS Балка для вывешивания двигателя

CZ Nosník k zavěšení motoru  
H Motorfelfüggesztő gerenda  
RO Grindă pt. suspendarea motorului  
F Poutre de suspension de moteur  
I Fascio sospensione del motore

E La viga para suspender el motor  
CN 发动机平衡架

**500kg max.**   
**150 cm**

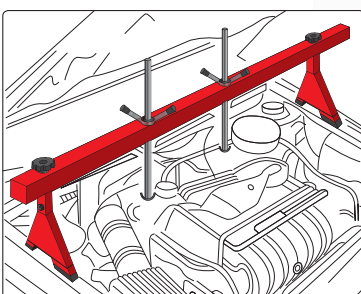

**YATO**    
YT-55568 1

GB Grease nipple set  
D Schmiernippel  
PL Zes aw smarowniczek  
RUS Набор масленок

CZ Sady mazacích hlavíc  
H Zsírzómb (zsírzófej) készlet  
RO Se resoare me a ice  
F Set de graisseurs métriques

I Set grasso capezzoli  
E Engrasador  
CN 件套黄油嘴组套

PLASTIC HANGING BOX



110 PCS

METRIC METRYCZNE



M6X1	M6X1 45°  5 pcs	M8X1  10 pcs	M8X1 90°  5 pcs	M10X1 90°  5 pcs	M10X1  10 pcs
60 pcs	M6X1 90°  5 pcs	M8X1 45°  5 pcs	M10X1 45°  5 pcs		



YT-06888



5/20

GB Copper washer set  
D Kupfer-dichtring-sortiment  
PL Zestaw podkładek miedzianych  
RUS Набор медных шайб

CZ Podložky měděné těsníci  
H Réz alátét készlet  
RO Saibe din cupru  
F Pa ins en cuivre

I Set di spessori  
E Arandelas de cobre  
CN 件套紫铜垫片

PLASTIC HANGING BOX



150 PCS

Cu



5x10x1 mm  10 pcs	8x11x1 mm  10 pcs	11x17x1.5 mm  10 pcs	12.5x20x1.5 mm  10 pcs	15x20x2 mm  10 pcs	16.5x24x2 mm  10 pcs
6x10x1 mm  10 pcs	10x16x1 mm  10 pcs	14x18x1 mm  10 pcs	14x20x1.5 mm  10 pcs	16x22x2 mm  10 pcs	17.5x24x2 mm  10 pcs
7x10x1 mm  10 pcs	10.5x17x1.5 mm  10 pcs	12x20x1.5 mm  10 pcs			



YT-06871



20

GB O-rin assor men  
D O-rin Sor imen  
PL Zestaw oringów gumowych  
RUS Набор резиновых прокладок

CZ Gumové „o“ kroužky sada  
H O gyűrű készlet  
RO Garnituri din cauciuc  
F Set d'o-rings en caoutchouc

I Se uarnizioni O-rin  
E Kit de junta tórica  
CN 件套O型圈组套

PLASTIC HANGING BOX



225 PCS

HEAT RESISTANT  
TEMPERATURÓOPORNE

OIL, PETROL, CHEMICAL RESISTANT  
OPORNE NA OLEJ, BENZYNIE, CHEMİKALIA



3x1 mm  20 pcs	4x1 mm  20 pcs	4.5x2 mm  20 pcs	5x2 mm  20 pcs	6x2 mm  20 pcs	6x2.5 mm  20 pcs
13x3 mm  5 pcs	14x2.5 mm  5 pcs	17x2.5 mm  5 pcs	18x4 mm  5 pcs	20x2 mm  5 pcs	22x2 mm  5 pcs
6x3 mm  20 pcs	7x2 mm  20 pcs	8x2 mm  20 pcs	9x2 mm  5 pcs	10x2 mm  5 pcs	12x3 mm  5 pcs



YT-06877



5/20



GB External circlip assortment  
D ussen-see errin -sor imen  
PL Zestaw pierścieni segera zewnętrznych  
RUS Кольца стопорные внешние  
CZ Sada pojistné kroužky  
H Külső seeger-gyűrű készlet

RO Se a rafe  
F Set de circlips ext.  
I Set all'esterno degli anelli Segera  
E Anillos seeger para agujeros exteriores  
CN 件套外挡圈组套



PLASTIC  
HANGING BOX



**300**  
PCS

EXTERNAL  
ZEWNĘTRZNE



YATO 	No.	inner diameter / średnica wewnętrzna (mm)	pcs. / szt.	No.	inner diameter / średnica wewnętrzna (mm)	pcs. / szt.	
YT-06880	R-01	3	20	R-11	14	15	5/20
	R-02	4	10	R-12	15	20	
	R-03	5	15	R-13	19	25	
	R-04	6	25	R-14	20	15	
	R-05	8	15	R-15	22	20	
	R-06	9	20	R-16	25	15	
	R-07	11	15	R-17	26	15	
	R-08	12	15	R-18	28	10	
	R-09	13	25	R-19	32	5	

GB Internal circlip assortment  
D nnen-see errin -sor imen  
PL Zestaw pierścieni segera wewnętrznych  
RUS Кольца стопорные внутренние  
CZ Sada pojistné kroužky  
H Belső seeger-gyűrű készlet

RO Se a rafe  
F Set de circlips int.  
I Set all'interno degli anelli Segera  
E Anillos seeger para agujeros interiores  
CN 件套内挡圈组套



PLASTIC  
HANGING BOX



**300**  
PCS

INTERNAL  
WEWNĘTRZNE



YATO 	No.	inner diameter / średnica wewnętrzna (mm)	pcs. / szt.	No.	inner diameter / średnica wewnętrzna (mm)	pcs. / szt.	
YT-06881	R-01	3	20	R-11	14	15	5/20
	R-02	4	10	R-12	15	20	
	R-03	5	15	R-13	19	25	
	R-04	6	25	R-14	20	15	
	R-05	8	15	R-15	22	20	
	R-06	9	20	R-16	25	15	
	R-07	11	15	R-17	26	15	
	R-08	12	15	R-18	28	10	
	R-09	13	25	R-19	32	5	

# 17

## Welding equipment & accessories Narzędzia spawalnicze i akcesoria



**Welding helmets**  
Przyłbice spawalnicze



380

**Profile connection & forming pliers**  
Szcypce do łączenia i kształtowania profili



384

**Ball peen hammers & sets**  
Młotki blacharskie i zestawy



381

**Magnetic holders**  
Wsporniki magnetyczne



385

**Dead blow hammers**  
Młotki bezodrzutowe



382

**Tin snips**  
Nożyce do blachy



386-389

**Lock grip pliers**  
Szcypce zaciskowe



383-384

**Self-locking multi grip pliers**  
Szcypce blacharskie..... 383

**Welding locking pliers**  
Szcypce zaciskowe, spawalnicze..... 383

**Flat locking pliers**  
Szcypce zaciskowe o szerokich szczękach..... 383

**C-type welding locking pliers**  
Szcypce zaciskowe, klamrowe typu „C”..... 384

**Chain locking pliers**  
Szcypce zaciskowe z łańcuchem..... 384

GB u o-darkenin we din he me  
 D Schweißsmaske se bs verdunke nd  
 PL Przyłbica spawalnicza samościemniająca  
 RUS Маска для сварки, самостоятельно затемняющаяся  
 CZ Svářečská kukla samostmívací

H Önmagától sötétedő hegesztőpajzs  
 RO Mască de sudură auto-întunecare  
 F Mas ue de souda e  
 I Oscuramen o casco di sa da ura  
 E Casco auto-obscurecedor para soldadura  
 CN 工具车双挂板

COLOR BOX

<b>DARK STATE</b> STAN CIEMNY <b>9-13</b>	<b>LIGHT STATE</b> STAN JASNY <b>4</b>	<b>REACTION TIME</b> CZAS REAKCJI <b>1/25000 s</b>	<b>BRIGHTENING TIME</b> CZAS ROZJAŚNIANIA <b>0.1-1.0 s</b>
<b>FILTER TEST</b> TEST FILTRA	<b>LOW BATTERY ALARM</b> WSKAZNIK POZIOMU BATERII	<b>2x3V CR2045</b> BATERIE, NIE WŁACZYĆ BATERII NIEODRĄŻNIONO	<b>WORKING TEMPERATURE</b> TEMPERATURA PRACY <b>-5°C +55°C</b>

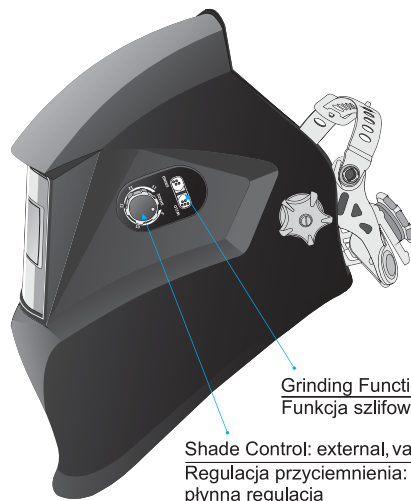

**Grinding Function: YES**  
 Funkcja szlifowania: TAK

**Shade Control: external, variable**  
 Regulacja przyciemnienia: zewnętrzna, płynna regulacja

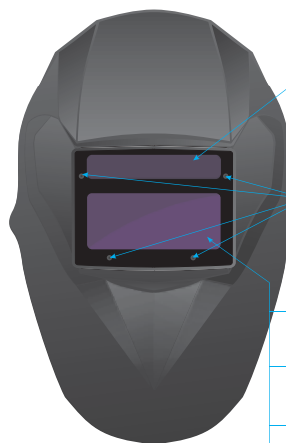

**Solar cell filter power supply during welding**  
 Ogniwo słoneczne zasilanie filtra podczas spawania

**Arc Sensor: 4**  
 Liczba czujników łuku: 4

**Viewing Area: 98x43mm**  
 Obszar pola widzenia: 98x43 mm

**UV/IR Protection**  
 Ochrona przed promieniowaniem UV/IR

**Automatic power on / off**  
 Automatyczne włączenie / wyłączenie

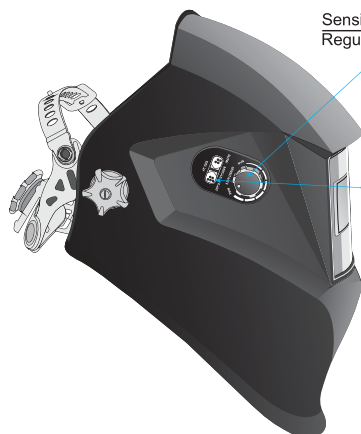

**Sensitivity Control**  
 Regulacja czułości

**The rate of dimming**  
 Szybkość ściemniania  
 0.3 - 1.0 ms

17

**4 POINT HEADGEAR**  
**WIĘŻBA 4 PUNKTOWA**

Lock into a detent when lifted  
 Blokada w pozycji podniesionej

3 position slider to adjust the distance from eyes to lens  
 3 pozycje regulacji odległości od filtra

Regulation at the occipital area  
 Regulacja pozycji potylicznej

Ratchet with soft rubber grip to adjust size without removing the helmet  
 Regulacji obwodu za pomocą systemu grzechotkowego

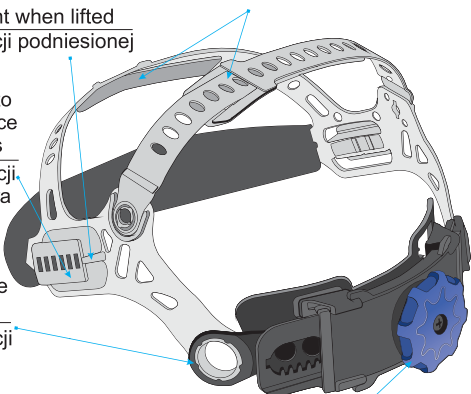

2-point crown strap adjustment to rise or lower the helmet  
 2 punktowa regulacja wysokości

N 379  
 optica propritie 1/2/1/3  
**właściwości optyczne: 1/2/1/3**

- GB u o bod fender se  
D Karosserie- usbeu sa z  
PL Komplet młotków blacharskich  
RUS Молотки рихтовочные  
CZ Souprava klempířských kladívek  
H Bádogos kalapács készlet
- RO Set de ciocane de tablă  
F Set pour carrossier  
I Martello per lamiera  
E Juego de mazos de hojalatero  
CN 钣金工具组套

7  
PCS

DROP  
FORGED  
KUTE

GENUINE  
HICKORY



BMC  
& COLOR  
SLEEVE



YATO	m ( )	
YT-4590	4900	4

- GB Ball pein hammer  
D usbeu hammer  
PL Młotek blacharski  
RUS Молоток рихтовочный  
CZ Klempířské kladívko  
H Bádogos kalapács
- RO Ciocan pt. tabla  
F Marteau à panne ronde  
I Martello per lamiera  
E Martillo de hojalatero  
CN 圆头锤

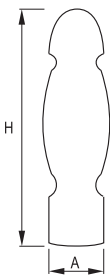

YATO	m ( )	L (mm)	A (mm)	H (mm)	
YT-4515	225	280	26	80	6/36
YT-4516	450	315	34	100	6/24
YT-4518	900	380	40	125	6/12

- GB Ball pein hammer  
D usbeu hammer  
PL Młotek blacharski  
RUS Молоток рихтовочный  
CZ Klempířské kladívko  
H Bádogos kalapács
- RO Ciocan pt. tabla  
F Marteau à panne ronde  
I Martello per lamiera  
E Martillo de hojalatero  
CN 圆头锤

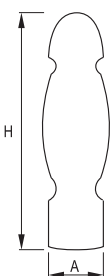

YATO	m ( )	L (mm)	A (mm)	H (mm)	
YT-4519	225	295	26	80	6/36
YT-4520	450	335	35	100	6/24
YT-4521	680	360	36	115	6/12
YT-4522	900	380	40	125	6/12

- GB Dead blow mallet
- D Rckschlaghammer
- PL Młotek bezodrzutowy
- RUS Молоток безинерционный
- CZ Palička nárazová plněná celogumová
- H Visszarúgás mentes gumikalapács
- RO Ciocan cu absorbție
- F Mallet sans recul
- I Martello morto colpo
- E Martillo sin reacción
- CN 防震无回弹橡胶锤

**PU**



YATO	m ( )	L (mm)	Ø (mm)	H (mm)	
YT-4624	265	318	30.0	94	10/40
YT-4625	430	350	40.0	100	6/36
YT-4626	490	348	45.0	110	6/36

- GB Dead blow mallet
- D Rckschlaghammer
- PL Młotek bezodrzutowy
- RUS Молоток безинерционный
- CZ Palička nárazová plněná celogumová
- H Visszarúgás mentes gumikalapács
- RO Ciocan cu absorbție
- F Mallet sans recul
- I Martello morto colpo
- E Martillo sin reacción
- CN 防震无回弹橡胶锤

**PU**

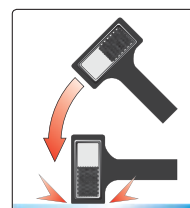

YATO	m ( )	L (mm)	Ø (mm)	H (mm)	
YT-4620	740	300	44.5	100.0	4/24
YT-4622	900	336	53.5	100.0	4/24
YT-4623	1300	350	59.0	118.5	3/12

- GB PU head mallet
- D Schonhammer mit PU & Nylon-Schlagkopf
- PL Młotek blacharski
- RUS Молоток рихтовочный
- CZ Palička klempířská
- H Vaskalapács
- RO Ciocan tinichigerie cap PU / nylon
- F Marteau spécial en PU/nylon
- I Martello per lamiera
- E Martillo chapista
- CN 木柄安装锤

**PU NYLON**



YATO	m ( )	L (mm)	Ø (mm)	H (mm)	
YT-4630	150	250	22	75	6/48
YT-4631	250	280	28	85	6/36
YT-4632	340	315	35	95	6/36
YT-4633	660	350	45	105	6/24
YT-4634	1340	380	60	132	4/16

17

- GB PU head for mallet
- D Polyurethan Schlagkopf
- PL Końcówka PU do młotka
- RUS Наконечник молотка из полиуретана
- CZ Náhradní koncovka k paličce PU
- H PU kalapácsfej cserélhető
- RO Cap PU pt. ciocan tinichigerie
- F Tête PU pour marteau
- I Bocca PU di ricambio
- E Cabeza PU para martillo chapista
- CN PU软头

**PU**

**SOFT**  
**MIĘKKA**



YATO	Ø (mm)	or / a	
YT-4635	22	YT-4630	6/60
YT-4636	28	YT-4631	6/60
YT-4637	35	YT-4632	6/60
YT-4638	45	YT-4633	6/60
YT-4639	60	YT-4634	6/60

- GB Nylon head for mallet
- D Nylon Schlagkopf
- PL Końcówka nylonowa do młotka
- RUS Наконечник молотка из твердого нейлона
- CZ Náhradní koncovka k paličce nylon
- H Műanyag kalapácsfej cserélhető
- RO Cap nylon pt. ciocan tinichigerie
- F Tête nylon pour marteau
- I Bocca di ricambio in nylon
- E Cabeza de nylon para martillo chapista
- CN 尼龙硬头

**NYLON**

**HARD**  
**TWARDA**



YATO	Ø (mm)	or / a	
YT-4640	22	YT-4630	6/60
YT-4641	28	YT-4631	6/60
YT-4642	35	YT-4632	6/60
YT-4643	45	YT-4633	6/60
YT-4644	60	YT-4634	6/60

GB Self-locking multi grip pliers  
D Grip-Festhaltezeange  
PL Szczypce blacharskie  
RUS Зажим ручной сварочный  
для закрепления лент и профилей  
CZ Kleště klempířské samodržící  
H Őnzáró rögzítőfogó  
RO Clește autoblocant pt. tinichigerie  
F Pince pour tôle  
I Pinze per lamiera  
E Pinzas de chapa  
CN 多功能大力钳

SLIDING  
CARD



200 mm  
0-15 mm  
70 mm  
TYPE W  
CrMo



YATO	L (mm)	
YT-2160	200	12/24

GB Self-locking multi grip pliers  
D Grip-Festhaltezeange  
PL Szczypce blacharskie  
RUS Зажим ручной сварочный  
для закрепления лент и профилей  
CZ Kleště klempířské samodržící  
H Őnzáró rögzítőfogó  
RO Clește autoblocant pt. tinichigerie  
F Pince pour tôle  
I Pinze per lamiera  
E Pinzas de chapa  
CN 多功能大力钳

SLIDING  
CARD



215 mm  
0-10 mm  
45 mm  
TYPE LL  
CrMo



YATO	L (mm)	
YT-2162	215	12/36

GB Welding locking pliers  
D K emmzan e zum Schweissen  
PL Szczypce zaciskowe spawalnicze  
RUS Клещи давяльные сварочные  
CZ Kleště samosvorné svářečské  
H Hegesztő fogó  
RO Clește de strângere pt. sudură  
F Pincés de serrage pour soudeur  
I Pinze di bloccaggio per saldatura  
E Pinzas de orni o  
(de apriete) para soldar  
CN 焊接用大力钳

HALF  
DOUBLE  
BLISTER



225 mm  
TYPE U



YATO	L (mm)	
YT-2461	225	6/24

GB Self-locking multi grip pliers  
D Grip-Festhaltezeange  
PL Szczypce blacharskie  
RUS Зажим ручной сварочный  
для закрепления лент и профилей  
CZ Kleště klempířské samodržící  
H Őnzáró rögzítőfogó  
RO Clește autoblocant pt. tinichigerie  
F Pince pour tôle  
I Pinze per lamiera  
E Pinzas de chapa  
CN 多功能大力钳

SLIDING  
CARD



230 mm  
0-15 mm  
45 mm  
TYPE JJ  
CrMo



YATO	L (mm)	
YT-2161	230	12/24

GB Self-locking multi grip pliers  
D Grip-Festhaltezeange  
PL Szczypce blacharskie  
RUS Зажим ручной сварочный  
для закрепления лент и профилей  
CZ Kleště klempířské samodržící  
H Őnzáró rögzítőfogó  
RO Clește autoblocant pt. tinichigerie  
F Pince pour tôle  
I Pinze per lamiera  
E Pinzas de chapa  
CN 多功能大力钳

SLIDING  
CARD



210 mm  
0-15 mm  
25 mm  
TYPE J  
CrMo



YATO	L (mm)	
YT-2163	210	12/36

GB Flat locking pliers  
D K emmzan e mi brei en Backen  
PL Szczypce zaciskowe o szerokich szczękach  
RUS Клещи давяльные с широкими губками  
CZ Kleště samosvorné se širokými čelistmi  
H Lapos fogó  
RO Clește de strângere plat / patent  
F Pincés de serra e ar e  
I Pinze con ganasce piane e paletta  
E Pinzas de tornillo (de apriete)  
con mordazas anchas  
CN 铁皮大力钳

HALF  
DOUBLE  
BLISTER



200 mm  
0-12.7 mm  
78 mm



YATO	L (mm)	
YT-2463	200	6/24

GB C-type welding locking pliers  
 D Klemm- und Klammerzange vom Typ „C“  
 PL Szczypce zaciskowe klamrowe typu „C“  
 RUS Клещи давящие типа „С“  
 CZ Kleště samosvorné upínací typu „C“  
 H „C“ fogó

RO Clește de strângere cu clemă tip „C“  
 F Pince de serrage type „C“  
 I Pinze di bloccaggio tipo „C“  
 E Pinzas de tornillo (de apriete) de grapa tipo „C“  
 CN C型大力钳



280 mm  
 0-100 mm  
 TYPE C



<b>YATO</b>	L (mm)	
YT-2466	280	6/24

<b>YATO</b>	L (mm)	
YT-2468	280	6/24

GB Chain locking pliers  
 D Klemmzange mit Kette  
 PL Szczypce zaciskowe z łańcuchem  
 RUS Клещи давящие с цепью  
 CZ Kleště samosvorné s řetězem  
 H Láncos csőfogó  
 RO Clește de strângere cu lanț  
 F Pince de serrage avec une chaîne  
 I Pinze di bloccaggio con catena  
 E Pinzas de tornillo (de apriete) con cadena  
 CN 链条大力钳



500 mm  
 40 Mn

<b>YATO</b>	
YT-2469	6/24

GB Profile connection pliers  
 D Zange zum Verbinden der Profile  
 PL Szczypce do łączenia profili  
 RUS Щипцы для соединения профилей  
 CZ Kleště ke spojování profilů  
 H Profilegyesítő fogó  
 RO Cleste pt. îmbinarea profilelor  
 F Pince pour servir les profiles  
 I Pinze per la unione profili  
 E Pinzas para conectar perfiles  
 CN 龙骨钳



275 mm  
 A380 ALLOY (HEAD)  
 GR15 BEARING STEEL (PUNCH)

<b>YATO</b>	L (mm)	
YT-5130	275	6/24



345 mm  
 65 Mn MATERIAL OF PUNCH (PUNKTAK)

<b>YATO</b>	L (mm)	
YT-5131	345	6/24

GB Profile forming pliers  
 D Zange zur Formgebung der Profile  
 PL Szczypce do kształtowania profili  
 RUS Щипцы для формовки профилей  
 CZ Kleště k tvarování profilů  
 H Profilformázó fogó  
 RO Cleste pt. modelarea profilelor  
 F Pince pour former les profiles  
 I Pinze per la formazione di profili  
 E Pinzas para formar perfiles  
 CN 龙骨钳



80x35 mm  
 JAWS  
 SZCZĘKI

<b>YATO</b>	L (mm)	
YT-5140	210	2/12

80x35 mm  
 JAWS  
 SZCZĘKI

<b>YATO</b>	L (mm)	
YT-5141	210	2/12

150x35 mm  
 JAWS  
 SZCZĘKI

<b>YATO</b>	L (mm)	
YT-5142	210	2/12



GB Adjustable angle welding magnet  
D ers e barer Ma ne - erks ckha er  
PL Wspornik magnetyczny spawalniczy regulowany  
RUS Регулируемый магнит заварки угла  
CZ Polohovací magnetický držák ke svařování  
H Állítható, mágneses, hegesztő támasz  
RO Dispozitiv magnetic reglabil pt. sudura  
F Support magnétique de soudure  
I Supporto della saldatura magnetico  
E Soporte magnético de soldadura, ajustable  
CN 焊接磁铁



DOUBLE  
BLISTER



YATO 	⌒ (k )	mm	
YT-0862	2x22.5	85 65 22	6

GB Ma ne ic we din ho der  
D Ma ne - erks ckha er  
PL Kątownik magnetyczny spawalniczy  
RUS Магнитная струбцина заварки



CZ Magnetický uhelník ke svařování  
H Mágneses, hegesztő szögvas  
RO Dispozitiv magnetic fixare pt. sudura  
F Support magnétique de soudure

I n o o ma ne ico da sa da ura  
E scuadra ma n ica de so dadura  
CN 焊接磁铁

DOUBLE  
BLISTER



YATO 	⌒ (k )	mm	
YT-0863	11.5	82 120 13	6/48

YATO 	⌒ (k )	∅ (mm)	mm	
YT-0864	22.5	18	102 155 17	6/30
YT-0865	34.0	46	122 190 25	6/18



GB Ma ne ic we din ho der  
D Ma ne - erks ckha er  
PL Kątownik magnetyczny spawalniczy z wyłącznikiem  
RUS Магнитная струбцина заварки с выключателем

CZ Magnetický uhelník ke svařování s vypínačem  
H Mágneses, hegesztő szögvas, kapcsolóval  
RO Dispozitiv magnetic fixare pt. sudura cu intreruptor  
F Support magnétique de soudure

I Trian o o ma ne ico da sa da ura  
con in erru ore  
E scuadra ma n ica de so dadura  
con interruptor  
CN 焊接磁铁

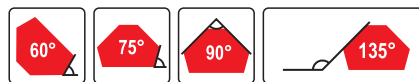
DOUBLE  
BLISTER



YATO 	⌒ (k )	mm	
YT-0866	11.5	64 95 14	6/24
YT-0867	34.0	111 136 24	6/18



GB Ma ne ic we din ho der wi h swi ch  
D Ma ne - erks ckha er mi Scha er  
PL Kątownik magnetyczny spawalniczy z wyłącznikiem  
RUS Магнитный держатель заварки с выключателем

CZ Magnetický uhelník ke svařování s vypínačem  
H Mágneses, hegesztő szögvas, kapcsolóval  
RO Dispozitiv magnetic fixare pt. sudura cu intreruptor  
F Support magnétique de soudure

I Trian o o ma ne ico da sa da ura  
con in erru ore  
E scuadra ma n ica de so dadura  
con interruptor  
CN 焊接磁铁

DOUBLE  
BLISTER



YATO 	⌒ (k )	mm	
YT-0870	13.5	107 160 26	6/24

GB Tin snips  
D B echscher  
PL Nożyce do cięcia blachy

RUS Ножницы по металлу  
CZ Nůžky na plech  
H emezvá ó ó ó

RO Foarfece pt. tablă  
F Cisaille à tôle  
I Cesioie per lamiere

E Tijeras para chapas  
CN 铁皮剪

SLIDING CARD



LEFT CUT  
CIECIE LEWE

CrMo

INCREASED CUTTING POWER  
ZWIĘKSZONA SIŁA CIECIE

HRC 60-62

DIN 6438



HRC 60-62

DIN 6438



YATO	L (mm)	cutting length (mm)	cutting capacities (mm)				6/36
			copper	co d-ro ed s ee	hard s ee HRC35	s ain ess s ee 304	
YT-1910	260	35	1.80	1.50	1.00	0.90	6/36

YATO	L (mm)	cutting length (mm)	cutting capacities (mm)				6/36
			copper	co d-ro ed s ee	hard s ee HRC35	s ain ess s ee 304	
YT-1915	235	30	1.50	1.20	1.00	0.70	6/36

HRC 60-62

DIN 6438



HRC 56-62

SERRATED EDGES  
ZABKOWANA KRAWĘDZ OSTRZY

HIGH FREQUENCY HARDENING  
HARTOWANIE IMPULSOWE



YATO	L (mm)	cutting length (mm)	cutting capacities (mm)				6/36
			copper	co d-ro ed s ee	hard s ee HRC35	s ain ess s ee 304	
YT-1918	260	32	1.80	1.50	1.00	0.90	6/36

YATO	L (mm)	cutting length (mm)	cutting capacities (mm)				6/36
			copper	co d-ro ed s ee	hard s ee HRC35	s ain ess s ee 304	
YT-1960	250	40	2.00	1.50	1.00	0.80	6/36

GB Tin snips  
D B echscher  
PL Nożyce do cięcia blachy  
RUS Ножницы по металлу  
CZ Nůžky na plech  
H emezvá ó ó ó  
RO Foarfece pt. tablă  
F Cisaille à tôle  
I Cesioie per lamiere  
E Tijeras para chapas  
CN 铁皮剪



LEFT CUT  
CIECIE LEWE

HRC 60-62

90°

CrMo

SERRATED EDGES  
ZABKOWANA KRAWĘDZ OSTRZY



SLIDING CARD



YATO	L (mm)	cutting length (mm)	cutting capacities (mm)				6/36
			copper	co d-ro ed s ee	hard s ee HRC35	s ain ess s ee 304	
YT-1913	225	30	0.78	0.53	0.46	0.36	6/36

GB Tin snips  
D B echscher  
PL Nożyce do cięcia blachy

RUS Ножницы по металлу  
CZ Nůžky na plech  
H emezvá ó ó ó

RO Foarfece pt. tablă  
F Cisaille à tôle  
I Cesioie per lamiere

E Tijeras para chapas  
CN 铁皮剪

SLIDING CARD



STRAIGHT CUT  
CIECIE PROSTE

CrMo

INCREASED CUTTING POWER  
ZWIĘKSZONA SIŁA CIECIE

HRC 60-62

DIN 6438



HRC 60-62

DIN 6438



YATO	L (mm)	cutting length (mm)	cutting capacities (mm)				6/36
			copper	co d-ro ed s ee	hard s ee HRC35	s ain ess s ee 304	
YT-1912	260	35	1.80	1.50	1.00	0.90	6/36

YATO	L (mm)	cutting length (mm)	cutting capacities (mm)				6/36
			copper	co d-ro ed s ee	hard s ee HRC35	s ain ess s ee 304	
YT-1922	290	75	1.10	0.94	0.70	0.53	6/36

HRC 60-62

DIN 6438



HRC 56-62

SERRATED EDGES  
ZABKOWANA KRAWĘDZ OSTRZY

HIGH FREQUENCY HARDENING  
HARTOWANIE IMPULSOWE



YATO	L (mm)	cutting length (mm)	cutting capacities (mm)				6/36
			copper	co d-ro ed s ee	hard s ee HRC35	s ain ess s ee 304	
YT-1923	230	25	2.00	1.60	1.20	1.20	6/36

YATO	L (mm)	cutting length (mm)	cutting capacities (mm)				6/36
			copper	co d-ro ed s ee	hard s ee HRC35	s ain ess s ee 304	
YT-1962	250	45	2.00	1.50	1.00	0.80	6/36

GB Tin snips  
D B echscherer  
PL Nożyce do cięcia blachy

RUS Ножницы по металлу  
CZ Nůžky na plech  
H emezvá ó ó ó

RO Foarfece pt. tablă  
F Cisaille à tôle  
I Cesioie per lamiere

E Tijeras para chapas  
CN 铁皮剪

SLIDING CARD



RIGHT CUT  
CIECIE PRAWIE

CrMo

INCREASED CUTTING POWER  
ZWIĘKSZONA SIŁA CIECIA

HRC 60-62

DIN 6438



HRC 60-62

DIN 6438



YATO	L (mm)	cutting length (mm)	cutting capacities (mm)				6/36
			copper	co d-ro ed s ee	hard s ee HRC35	s ain ess s ee 304	
YT-1911	260	35	1.80	1.50	1.00	0.90	6/36

YATO	L (mm)	cutting length (mm)	cutting capacities (mm)				6/36
			copper	co d-ro ed s ee	hard s ee HRC35	s ain ess s ee 304	
YT-1916	235	30	1.50	1.20	1.00	0.70	6/36

HRC 60-62

DIN 6438



HRC 56-62

SERRATED EDGES  
ZABKOWANA KRAWĘDZ OSTRZY

HIGH FREQUENCY HARDENING  
HARTOWANIE IMPULSOWE



YATO	L (mm)	cutting length (mm)	cutting capacities (mm)				6/36
			copper	co d-ro ed s ee	hard s ee HRC35	s ain ess s ee 304	
YT-1919	260	32	1.80	1.50	1.00	0.90	6/36

YATO	L (mm)	cutting length (mm)	cutting capacities (mm)				6/36
			copper	co d-ro ed s ee	hard s ee HRC35	s ain ess s ee 304	
YT-1961	250	40	2.00	1.50	1.00	0.80	6/36

GB Tin snips  
D B echscherer  
PL Nożyce do cięcia blachy  
RUS Ножницы по металлу  
CZ Nůžky na plech  
H emezvá ó ó ó  
RO Foarfece pt. tablă  
F Cisaille à tôle  
I Cesioie per lamiere  
E Tijeras para chapas  
CN 铁皮剪



RIGHT CUT  
CIECIE PRAWIE

HRC 60-62

CrMo

90°

SERRATED EDGES  
ZABKOWANA KRAWĘDZ OSTRZY

SLIDING CARD



YATO	L (mm)	cutting length (mm)	cutting capacities (mm)				6/36
			copper	co d-ro ed s ee	hard s ee HRC35	s ain ess s ee 304	
YT-1914	225	30	0.78	0.53	0.46	0.36	6/36

GB Tin snips  
D B echscherer  
PL Nożyce do cięcia blachy  
RUS Ножницы по металлу  
CZ Nůžky na plech  
H emezvá ó ó ó  
RO Foarfece pt. tablă  
F Cisaille à tôle  
I Cesioie per lamiere  
E Tijeras para chapas  
CN 铁皮剪



LEFT CUT  
CIECIE LEWE

DROP FORGED KUTE

HRC 58-61

SLIDING CARD



YATO	L (mm)	cutting length (mm)	cutting capacities (mm)				6/24
			copper	co d-ro ed s ee	hard s ee HRC35	s ain ess s ee 304	
YT-1900	260	30	0.94	0.78	0.60	0.45	6/24

GB Tin snips  
D B echscherer  
PL Nożyce do cięcia blachy  
RUS Ножницы по металлу  
CZ Nůžky na plech  
H emezvá ó ó ó

RO Foarfece pt. tablă  
F Cisaille à tôle  
I Cesioie per lamiere  
E Tijeras para chapas  
CN 铁皮剪

SLIDING CARD



RIGHT CUT  
CIECIE PRAWIE

DROP FORGED KUTE

HRC 58-61



YATO	L (mm)	cutting length (mm)	cutting capacities (mm)				6/24
			copper	co d-ro ed s ee	hard s ee HRC35	s ain ess s ee 304	
YT-1901	260	30	0.94	0.78	0.60	0.45	6/24

YATO	L (mm)	cutting length (mm)	cutting capacities (mm)				6/24
			copper	co d-ro ed s ee	hard s ee HRC35	s ain ess s ee 304	
YT-1902	300	50	0.94	0.78	0.60	0.45	6/24

GB Tin snips  
D B echscher  
PL Nożyce do cięcia blachy  
RUS Ножницы по металлу

CZ Nůžky na plech  
H emezvá ó ó ó  
RO Foarfece pt. tablă  
F Cisaille à tôle

I Cesioie per lamiere  
E Tijeras para chapas  
CN 铁皮剪

SLIDING CARD



For cutting straight and tight curves left or right



**HRC 58-61**

YATO	L (mm)	cutting length (mm)	cutting capacities (mm)				6/36
			copper	co d-ro ed s ee	hard s ee HRC35	s ain ess s ee 304	
YT-1924	254	52	0.94	0.78	0.60	0.45	6/36



STRAIGHT CUT  
CIECIE PROSTE  
**HRC 58-61**  
DROP FORGED  
KUTE

YATO	L (mm)	cutting length (mm)	cutting capacities (mm)				6/36
			copper	co d-ro ed s ee	hard s ee HRC35	s ain ess s ee 304	
YT-1925	225	52	0.94	0.78	0.60	0.45	6/36



**HRC 58-60**

YATO	L (mm)	cutting length (mm)	cutting capacities (mm)				6/36
			copper	co d-ro ed s ee	hard s ee HRC35	s ain ess s ee 304	
YT-1920	260	42	1.20	1.00	0.60	0.50	6/36

GB Tin snips  
D B echscher  
PL Nożyce do cięcia blachy  
RUS Ножницы по металлу  
CZ Nůžky na plech  
H emezvá ó ó ó  
RO Foarfece pt. tablă  
F Cisaille à tôle  
I Cesioie per lamiere  
E Tijeras para chapas  
CN 铁皮剪

SLIDING CARD



**S55C**  
DROP FORGED STEEL  
STAL KUTA NA ZIMNO  
**HRC 55-60**

HIGH FREQUENCY HARDENING  
HARTOWANIE IMPULSOWE

GB Tin snips  
D B echscher  
PL Nożyce do cięcia blachy  
RUS Ножницы по металлу  
CZ Nůžky na plech  
H emezvá ó ó ó  
RO Foarfece pt. tablă  
F Cisaille à tôle  
I Cesioie per lamiere  
E Tijeras para chapas  
CN 铁皮剪

SLIDING CARD



**S55C**  
DROP FORGED STEEL  
STAL KUTA NA ZIMNO  
**HRC 55-60**

HIGH FREQUENCY HARDENING  
HARTOWANIE IMPULSOWE



YATO	L (mm)	cutting length (mm)	cutting capacities (mm)				6/36
			copper	co d-ro ed s ee	hard s ee HRC35	s ain ess s ee 304	
YT-1963	200	40	1.5	1.0	0.6	0.6	6/36
YT-1964	250	60	1.8	1.2	0.8	0.8	6/24
YT-1965	300	75	2.0	1.4	0.8	0.8	6/12



YATO	L (mm)	cutting length (mm)	cutting capacities (mm)				6/36
			copper	co d-ro ed s ee	hard s ee HRC35	s ain ess s ee 304	
YT-1970	260	42	2.0	1.4	1.0	1.0	6/36

- GB Steel strap cutter  
D Stahlurbandschere  
PL Nożyce do cięcia taśmy stalowej  
RUS Ножницы для резки стальной ленты  
CZ Nůžky na plech  
H Iremezválóóó  
RO Foarfece pt. tablă  
F Cisaille à bande acier  
I Cesoia per taglio reggetta in acciaio  
E Tijeras para bandejas de acero  
CN 钢带剪

HRC  
58-61

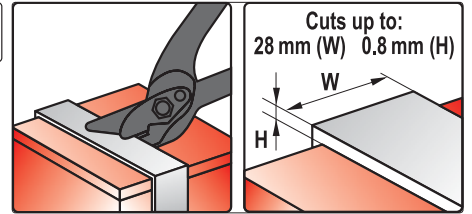

Cuts up to:  
28 mm (W) 0.8 mm (H)



SLIDING  
CARD

YATO	L (mm)	cutting length (mm)	cutting capacities (mm)			6/24
			copper	co d-ro ed s ee	hard s ee HRC35	
YT-1930	305	28	-	1.00	0.80	0.60

- GB Porabeneherschere  
D Schere zum Ausschneiden von Ecken  
PL Nożyce do wycinania naroży  
RUS Ножницы для наружных углов  
CZ Nůžky na vystřihování rohů  
H Sarokkiválóóó
- RO Foarfece pt. taierea colturilor  
F Ciseaux pour le coupage des coins  
I Cesoie per taglio reggetta in angoli  
E Tijera para esquinas  
CN 截角器

300  
mm 90°

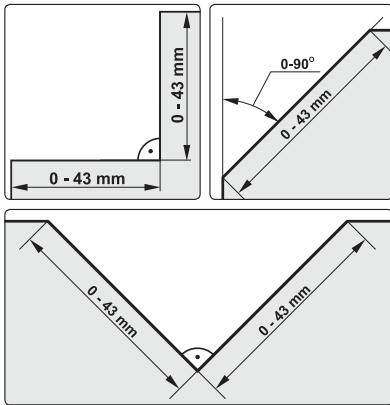

COLOR  
BOX

YATO	L (mm)	15
YT-1939	300	15

- GB Straight pliers  
D Zange zum Biechen  
PL Kleszce do gięcia blach  
RUS Клещи с тупым ножом для жести  
CZ Kleště na ohýbání plechu  
H Falcfogó  
RO Cleste pt. indoirea tablei
- F Pince à fléchir la tôle  
I Taglie per la lamiera  
E Tenazas para doblar hojalata  
CN 钣金钳



COLOR  
BOX



45° 55 mm

90° 55 mm



















180° 60 mm

YATO	L (mm)	10/20	YATO	L (mm)	10/20	YATO	L (mm)	10/20
YT-5416	280	10/20	YT-5417	260	10/20	YT-5415	280	10/20

# 18



**Power & gasoline tools**  
**Elektronarzędzia**  
**i narzędzia spalinowe**





Angle grinders Szlifierki kątowe		392	Multi-purpose oscillating tools Wielofunkcyjne narzędzia oscylacyjne		399
Drilling machines Wiertarki		393-394	Hot air guns Opalarki		400
Drywall screwdrivers Wkrętarki do regipsów		394	Knives Noże		401
Rotary hammers Młotowiertarki		395	Pipe welders Zgrzewarki do rur		401
Jig saws Wyrzynarki		396	Generators Generatory		402-403
Circular saws Pilarki tarczowe		397	Pumps Pompy		404
Planers Strugi		397	Electric hoists Elektryczne wciągarki linowe		405
Miter saws Ukośnice		398	Burners & soldering tools Palniki i lutownice		406-408
Sabre saws Piły szablaste		398	Glue guns Pistolety do klejenia		409

GB n e rinder  
 D inke sch eifmaschine  
 PL Szlifierka kątowa  
 RUS Угловой шлифовальный станок  
 CZ h ová bruska  
 H Sarokcsiszó ók  
 RO Po izer un h iu ar  
 F Meuseuse d'an e  
 I Sme i ia rice an o are  
 E Ljadera de angulo  
 CN 角向磨光机





230V~50Hz **710 W**  
 11000 min<sup>-1</sup>   
**M14** 

COLOR BOX



<b>YATO</b> 	
YT-82090	6

GB n e rinder  
 D inke sch eifmaschine  
 PL Szlifierka kątowa  
 RUS Угловой шлифовальный станок  
 CZ h ová bruska  
 H Sarokcsiszó ók  
 RO Po izer un h iu ar  
 F Meuseuse d'an e  
 I Sme i ia rice an o are  
 E Ljadera de angulo  
 CN 角向磨光机





230V~50Hz **950 W**  
 11000 min<sup>-1</sup>   
**M14** 

COLOR BOX

<b>YATO</b> 	
YT-82095	6

GB n e rinder  
 D inke sch eifmaschine  
 PL Szlifierka kątowa  
 RUS Угловой шлифовальный станок  
 CZ h ová bruska  
 H Sarokcsiszó ók  
 RO Po izer un h iu ar  
 F Meuseuse d'an e  
 I Sme i ia rice an o are  
 E Ljadera de angulo  
 CN 角向磨光机



230V~50Hz **2200 W**  
 6000 min<sup>-1</sup>   
**M14** 

COLOR BOX

<b>YATO</b> 	
YT-82102	2



GB Impact drill  
D Sch a bohmaschine  
PL ier arka udarowa  
RUS Ударная дрель  
CZ Nárazová vrtačka  
H Kezelési utasítás  
RO Masina de auri  
F Perceuse à percussion  
I Trapano a percussione  
E Taladradora de percusión  
CN 冲击钻

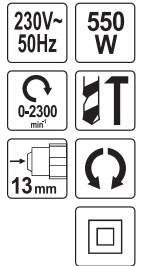

COLOR  
BOX

YATO 		
YT-82030	550	5

GB Impact drill  
D Sch a bohmaschine  
PL ier arka udarowa  
RUS Ударная дрель  
CZ Nárazová vrtačka  
H Kezelési utasítás  
RO Masina de auri  
F Perceuse à percussion  
I Trapano a percussione  
E Taladradora de percusión  
CN 冲击钻

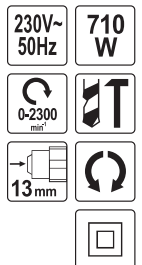

COLOR  
BOX

YATO 		
YT-82035	710	5

GB Impact drill  
D Sch a bohmaschine  
PL ier arka udarowa  
RUS Ударная дрель  
CZ Nárazová vrtačka  
H Kezelési utasítás  
RO Masina de auri  
F Perceuse à percussion  
I Trapano a percussione  
E Taladradora de percusión  
CN 冲击钻

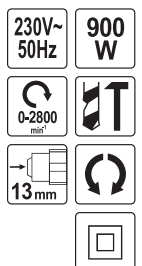







COLOR  
BOX

YATO 		
YT-82040	900	5



GB ec ric dri  
 D ek robohrmaschine  
 PL ier arka e ek r czna  
 RUS Электрическая дрель  
 CZ Elektrická vrtačka  
 H Elektromos fúrógép  
 RO Mașină de găurit electrică  
 F Perceuse à m a  
 I Trapano  
 E Ta adro e c rico  
 CN 电钻



230V~ 50Hz	550 W	0-2700 min <sup>-1</sup>
10 mm		
		









COLOR  
BOX

<b>YATO</b> 	
YT-82050	5

GB ec ric dri  
 D ek robohrmaschine  
 PL ier arka e ek r czna  
 RUS Электрическая дрель  
 CZ Elektrická vrtačka  
 H Elektromos fúrógép  
 RO Mașină de găurit electrică  
 F Perceuse à m a  
 I Trapano  
 E Ta adro e c rico  
 CN 电钻



230V~ 50Hz	580 W	0-1300 min <sup>-1</sup>
10 mm		
		



COLOR  
BOX

<b>YATO</b> 	
YT-82051	5

GB Dr wa screwdriver  
 D Trockenbauschrauber  
 PL Wkrętarka elektryczna  
 RUS Сетевой шуруповерт  
 CZ Sádronkartonářský šroubovák  
 H Gipszkarton csavarzó  
 RO Șurubelniță pt. gips-carton  
 F Perceuse aux plaques de plâtre  
 I Trapano  
 E Atornilladores para construcción en seco  
 CN 墙板螺丝刀



230V~ 50Hz	500 W
0-1600 min <sup>-1</sup>	1/4" 6.3 mm
	

COLOR  
BOX

<b>YATO</b> 	
YT-82070	5

GB Rotary hammer  
D Bohrerhammer  
PL Młotowiertarka SDS-plus  
RUS Перфоратор  
CZ Vrtací kladivo  
H Fűrőkalapács  
RO Ciocan rotopercutor  
F Marteau perforateur  
I Martello rotativo  
E Martillo perforador  
CN 电锤

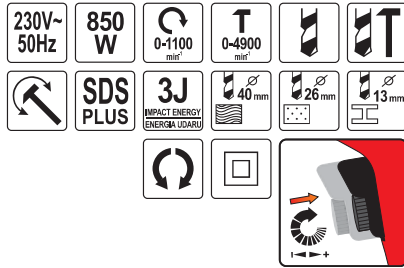

BMC  
& COLOR  
SLEEVE

<b>YATO</b>	W	
YT-82120	850	2

GB Rotary hammer  
D Bohrerhammer  
PL Młotowiertarka SDS-plus  
RUS Перфоратор  
CZ Vrtací kladivo  
H Fűrőkalapács  
RO Ciocan rotopercutor  
F Marteau perforateur  
I Martello rotativo  
E Martillo perforador  
CN 电锤

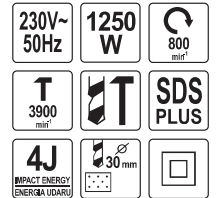

BMC  
& COLOR  
SLEEVE

<b>YATO</b>	W	
YT-82125	1250	2

GB Rotary hammer  
D Bohrerhammer  
PL Młotowiertarka SDS-plus  
RUS Перфоратор  
CZ Vrtací kladivo  
H Fűrőkalapács  
RO Ciocan rotopercutor  
F Marteau perforateur  
I Martello rotativo  
E Martillo perforador  
CN 电锤

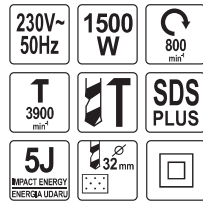

BMC  
& COLOR  
SLEEVE

<b>YATO</b>	W	
YT-82127	1500	2

GB Rotary hammer  
D Bohrerhammer  
PL Młotowiertarka SDS-max  
RUS Перфоратор  
CZ Vrtací kladivo  
H Fűrőkalapács  
RO Ciocan rotopercutor  
F Marteau perforateur  
I Martello rotativo  
E Martillo perforador  
CN 电锤

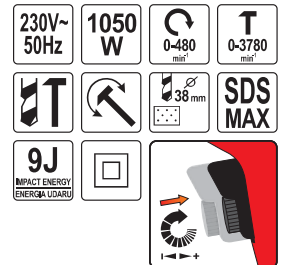

BMC  
& COLOR  
SLEEVE



<b>YATO</b>	W	
YT-82130	1050	2

GB Ji saw  
 D S ichsä e  
 PL rz narka  
 RUS Электрический лобзик  
 CZ Přímočará pila  
 H Szűrőfűrész  
 RO Ferăstrău pt. traforaj  
 F Scie sau euse  
 I Se he o a erna ivo  
 E Sierra de ca ar  
 CN 曲线锯



230V~50Hz	550 W
800-2600 mm <sup>2</sup>	65 mm
6 mm	

COLOR BOX

<b>YATO</b> 	
YT-82270	550 5

GB Ji saw  
 D S ichsä e  
 PL rz narka  
 RUS Электрический лобзик  
 CZ Přímočará pila  
 H Szűrőfűrész  
 RO Ferăstrău pt. traforaj  
 F Scie sau euse  
 I Se he o a erna ivo  
 E Sierra de ca ar  
 CN 曲线锯



230V~50Hz	750 W
800-3000 mm <sup>2</sup>	80 mm
6 mm	

COLOR BOX

<b>YATO</b> 	
YT-82271	750 5

GB Ji saw  
 D S ichsä e  
 PL rz narka  
 RUS Электрический лобзик  
 CZ Přímočará pila  
 H Szűrőfűrész  
 RO Ferăstrău pt. traforaj  
 F Scie sau euse  
 I Se he o a erna ivo  
 E Sierra de ca ar  
 CN 曲线锯



230V~50Hz	750 W
800-3000 mm <sup>2</sup>	110 mm
10 mm	

COLOR BOX

<b>YATO</b> 	
YT-82272	750 5

GB Circular saw  
D Handkreissäge  
PL Piarka  
RUS Дисковая пила  
CZ Ručná kružná pila  
H Kézi körfűrész  
RO Ferăstrău circular de mână  
F Tronçonneuse  
I Sega circolare  
E Sierra circular  
CN 电圆锯

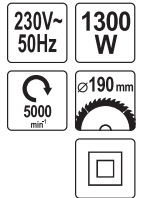

COLOR  
BOX

YATO 		
YT-82150	1300	2

GB Circular saw  
D Handkreissäge  
PL Piarka  
RUS Дисковая пила  
CZ Ručná kružná pila  
H Kézi körfűrész  
RO Ferăstrău circular de mână  
F Tronçonneuse  
I Sega circolare  
E Sierra circular  
CN 电圆锯

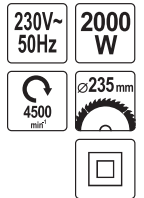

COLOR  
BOX

YATO 		
YT-82153	2000	2

GB Electric planer  
D Elektrorohbe  
PL Srubekgiczn  
RUS Электрорубанок  
CZ Elektrický hoblík  
H Elektroromsau  
RO Rindea electrică  
F Rabot  
I Piaa elettrica  
E Garlopa electrica  
CN 电刨

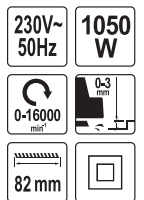

COLOR  
BOX

YATO 		
YT-82140	1050	4

GB Mi re saw  
 D Panee sä e  
 PL Ukošnica  
 RUS Панельная пила  
 CZ Pokosová pila se zákluzem  
 H Sínes gérvágó  
 RO Ferăstrău circular staționar  
 F Scie à on e radiale  
 I Se a an oare a io e he  
 E Ingletadora telescópica  
 CN 斜切锯



GB Mi re saw  
 D Panee sä e  
 PL Ukošnica  
 RUS Панельная пила  
 CZ Pokosová pila se zákluzem  
 H Sínes gérvágó  
 RO Ferăstrău circular staționar  
 F Scie à on e radiale  
 I Se a an oare a io e he  
 E Ingletadora telescópica  
 CN 斜切锯

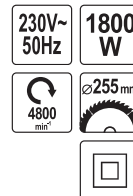

COLOR BOX

<b>YATO</b> 	
YT-82170 1800	1



COLOR BOX

<b>YATO</b> 	
YT-82171 1800	1

GB Reciprocating saw  
 D Säge sä e  
 PL Pila szablasta  
 RUS Сабельная пила  
 CZ Pí a ocaska  
 H Szablyafűrész  
 RO Ferăstrău tip sabie  
 F Scie sabre  
 I Se a e e rica a erna iva  
 E Serra de sabre  
 CN 往复锯



COLOR BOX

<b>YATO</b> 	
YT-82280 1200	4

GB Multi-purpose oscillating tool  
D Multifunktionales Oszillationswerkzeug  
PL Wielofunkcyjne narzędzie oscylacyjne  
RUS Многофункциональный инструмент  
CZ Multifunkční oscilační nářadí  
H Multifunkciós rezgő szerszám  
RO Unealtă multifuncțională oscilantă  
F Outil multifonctions oscillant  
I Oscilante multifunczionale  
E Herramienta oscilatoria multifuncional  
CN 多功能啊雄莓



230V~50Hz  
300W  
15000-22000 min<sup>-1</sup>  
BMC & COLOR SLEEVE

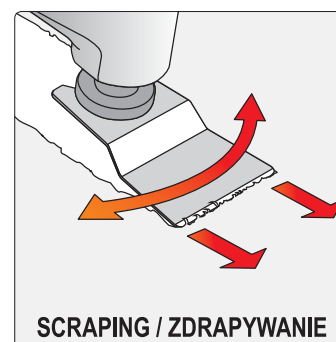
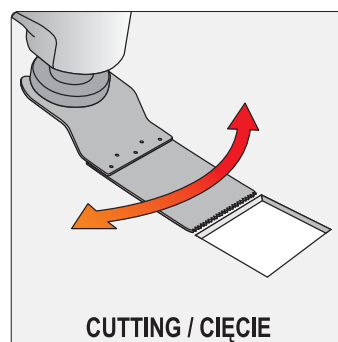
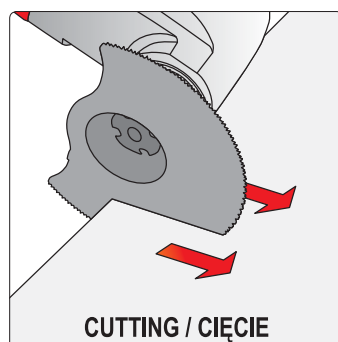
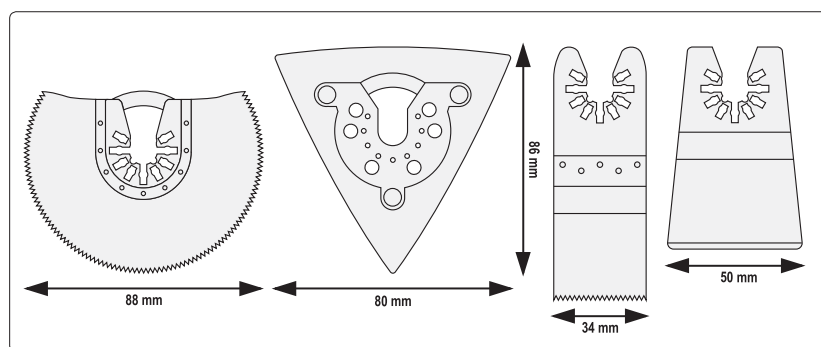
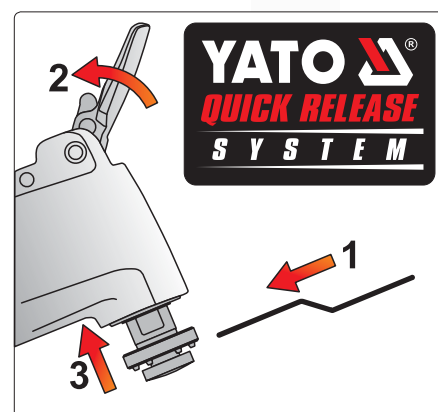

GB Ho air un  
 D Heissluftpistole  
 PL Opalarka  
 RUS Фен для обжигания краски  
 CZ Opalovací stroj  
 H Hőlégfúvó  
 RO Fion pt. ars vopseaua  
 F Décapeur thermique  
 I Generatore aria calda  
 E Secadora  
 CN 热风枪

230V~50Hz 2000W 550°C  
 500 l/min



COLOR BOX

<b>YATO</b>		
YT-82288	2000	10

GB Ho air un with accessories  
 D Heissluftpistole  
 PL Opalarka z akcesoriami  
 RUS Фен для обжигания краски в наборе  
 CZ Opalovací stroj s příslušenstvím  
 H Hőlégfúvó tartozékokkal  
 RO Fion cu accesorii pt. ars vopseaua  
 F Décapeur thermique  
 I Generatore aria calda con accessori  
 E Secadora con accesorios  
 CN 热风枪

230V~50Hz 2000W 550°C  
 500 l/min



BMC & COLOR SLEEVE

<b>YATO</b>		
YT-82291	2000	5

GB Ho air un with accessories  
 D Heissluftpistole  
 PL Opalarka z akcesoriami  
 RUS Фен для обжигания краски в наборе  
 CZ Opalovací stroj s příslušenstvím  
 H Hőlégfúvó tartozékokkal  
 RO Fion cu accesorii pt. ars vopseaua  
 F Décapeur thermique  
 I Generatore aria calda con accessori  
 E Secadora con accesorios  
 CN 热风枪

230V~50Hz 2000W 550°C  
 500 l/min  
 LED

T M AT  
 AD STM NT



LA A  
 T M AT Y

GB Ho air un with accessories  
 D Heissluftpistole  
 PL Opalarka z akcesoriami  
 RUS Фен для обжигания краски в наборе  
 CZ Opalovací stroj s příslušenstvím  
 H Hőlégfúvó tartozékokkal  
 RO Fion cu accesorii pt. ars vopseaua  
 F Décapeur thermique  
 I Generatore aria calda con accessori  
 E Secadora con accesorios  
 CN 热风枪

230V~50Hz 2000W 600°C  
 500 l/min  
 LCD DISPLAY

T M AT  
 AD STM NT



LA A  
 T M AT Y



BMC & COLOR SLEEVE

<b>YATO</b>		
YT-82292	2000	5



BMC & COLOR SLEEVE

<b>YATO</b>		
YT-82293	2000	5



GB Thermal knife for polystyrene foam  
D Thermomesser für Styropor  
PL Nóż termiczny do styropianu  
RUS Термонож для пенопласта

CZ Termický nůž na pěnový polystyrén  
H Polisztírol vágó hőkés  
RO Cuițit termic pt. stiropian  
F Cou eau hermi ue à s rofoam

I Coltello termico per polistirolo  
E Cuchilla térmica para poliestireno  
CN 热切割刀

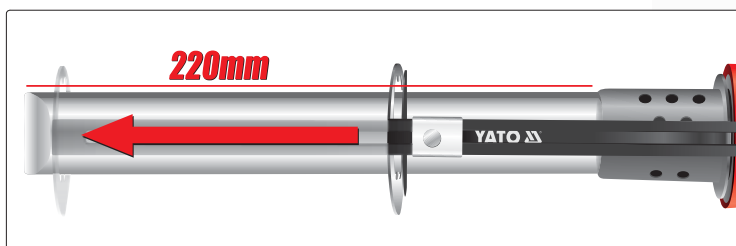
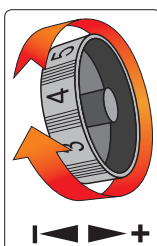
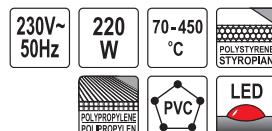

COLOR BOX



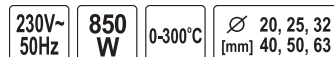

YATO 	L (mm)		
YT-82190	220	220	10

GB PVC plastic pipe welder  
D Schweißgerät für thermoplastische Rohre  
PL Zgrzewarka do rur termoplastycznych  
RUS Сварочная машина для термопластиковых труба  
CZ Svářečka na termoplastické trubky  
H Hegesztő berendezés termoplasztikus csövekhez  
RO Masina de sudat tevi termoplastice  
F Soudeur en u au érie en P C  
I Polifusore saldatore per tubi  
E Maquina de soldar las tubos termoplasticos  
CN 热熔器



METAL CASE & COLOR BOX



YATO 	L (mm)		
YT-82250	850		2

GB Gasoline generator  
 D Stromgenerator  
 PL Generator prądowórczy  
 RUS Генератор тока  
 CZ Generátor vytvářející proud  
 H Áramfejlesztő generátorhoz  
 RO Generator de curen  
 F Groupe électrogène  
 I Generatore di corrente  
 E Generator de corrient e  
 CN 婦柏发电机



230V-50Hz  
2x

2.5 kW

196 cm<sup>3</sup>

Pb 151

10.9 A



GREY  
 CARTON BOX  
 & COLOR  
 LABEL



<b>YATO</b>			
YT-85432	2.5		1

GB Gasoline generator  
 D Stromgenerator  
 PL Generator prądowórczy  
 RUS Генератор тока  
 CZ Generátor vytvářející proud  
 H Áramfejlesztő generátorhoz  
 RO Generator de curen  
 F Groupe électrogène  
 I Generatore di corrente  
 E Generator de corrient e  
 CN 婦柏发电机



230V-50Hz  
2x

3.2 kW

242 cm<sup>3</sup>

Pb 251

13.9 A



GREY  
 CARTON BOX  
 & COLOR  
 LABEL



<b>YATO</b>			
YT-85434	3.2		1

GB Gasoline generator  
 D Stromgenerator  
 PL Generator prądowórczy  
 RUS Генератор тока  
 CZ Generátor vytvářející proud  
 H Áramfejlesztő generátorhoz  
 RO Generator de curen  
 F Groupe électrogène  
 I Generatore di corrente  
 E Generator de corrient e  
 CN 婦柏发电机



230V-50Hz  
2x

4.0 kW

389 cm<sup>3</sup>

Pb 251

17.4 A



GREY  
 CARTON BOX  
 & COLOR  
 LABEL



<b>YATO</b>			
YT-85437	4.0		1

GB Gasoline generator  
 D Stromgenerator  
 PL Generator prądowórczy  
 RUS Генератор тока  
 CZ Generátor vytvářející proud  
 H Áramfejlesztő generátorhoz  
 RO Generator de curen  
 F Groupe électrogène  
 I Generatore di corrente  
 E Generator de corrient e  
 CN 婦柏发电机



230V-50Hz  
2x

5.0 kW

389 cm<sup>3</sup>

Pb 251

21.7 A



GREY  
 CARTON BOX  
 & COLOR  
 LABEL



<b>YATO</b>			
YT-85440	5.0		1



- GB Gasoline water pump
- D Pumpe mit verbrennungsmotor
- PL Pompa spalinowa
- RUS Бензонасос
- CZ Čerpadlo se spalovacím motorem
- H Robbanómóros szivattyú
- RO Pompa cu motor cu ardere în erna
- F Pompe à eau
- I Motorpompa
- E Bomba de combustión
- CN 汽油抽水泵



4.1 kW	
163 cm³	
Q <sub>MAX</sub> 36m³/h	
3.6 l	



COLOR BOX



<b>YATO</b> 	
YT-85401	1

- GB Gasoline water pump
- D Pumpe mit verbrennungsmotor
- PL Pompa spalinowa
- RUS Бензонасос
- CZ Čerpadlo se spalovacím motorem
- H Robbanómóros szivattyú
- RO Pompa cu motor cu ardere în erna
- F Pompe à eau
- I Motorpompa
- E Bomba de combustión
- CN 汽油抽水泵



4.1 kW	
163 cm³	
Q <sub>MAX</sub> 60m³/h	
3.6 l	

COLOR BOX



<b>YATO</b> 	
YT-85402	1

- GB Gasoline water pump
- D Pumpe mit verbrennungsmotor
- PL Pompa spalinowa
- RUS Бензонасос
- CZ Čerpadlo se spalovacím motorem
- H Robbanómóros szivattyú
- RO Pompa cu motor cu ardere în erna
- F Pompe à eau
- I Motorpompa
- E Bomba de combustión
- CN 汽油抽水泵



4.1 kW	
242 cm³	
Q <sub>MAX</sub> 96m³/h	
3.6 l	

COLOR BOX



<b>YATO</b> 	
YT-85403	1

























- GB Electric hoist
- D Elektrische Winde
- PL Elektryczny wciągnik linowy
- RUS Электрическая канатная лебёдка
- CZ Elektrický naviják kladkostroj
- H Elektromos csőróló
- RO Troiu electrică cu cablu
- F Treuil électrique à corde
- I verrice elettrica
- E Cabria eléctrica de cuerdas
- CN 电动葫芦

COLOR BOX



~230V  
50Hz



<b>500 W</b>		
		
<b>YATO</b>		
YT-5901	500	2
<b>550 W</b>		
		
<b>YATO</b>		
YT-5902	550	2
<b>900 W</b>		
		
<b>YATO</b>		
YT-5904	900	2
<b>1050 W</b>		
		
<b>YATO</b>		
YT-5905	1050	2

GB Gas orch  
D Gasbrenner  
PL Pałnik azowy  
RUS Газовая паяльная  
лампа  
CZ Plynový hořák  
H Gázégő

RO Arzător de gaz  
F Bruleur à gaz  
I Saldatore a gas  
E Soplete de gas  
CN 火焰枪

PIEZO ELECTRIC  
1350°C  
60 ml  
200 min



**YATO**  
YT-6700 6/24

GB Gas orch  
D Gasbrenner  
PL Pałnik azowy  
RUS Газовая паяльная  
лампа  
CZ Plynový hořák  
H Gázégő

RO Arzător de gaz  
F Bruleur à gaz  
I Saldatore a gas  
E Soplete de gas  
CN 火焰枪

PIEZO  
30 ml  
60-90 min  
GAS GAZ  
LOCK BLOKADA  
BUTANE lighter gas  
BUTAN (gaz do zapalniczki)  
CHILD PROTECTION  
ZABEZPECZENIE  
PRZED DZIECIAMI

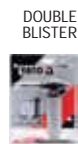
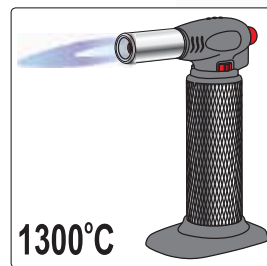

**YATO**  
YT-36700 10/20

GB Butane soldering iron  
D Gasöko ben  
PL uownica azowa  
RUS Паяльник газовый  
CZ Plynová pájka  
H Forrasztópisztoly ceruza  
bután gáz üzemű  
RO Surubelni a sudura cu gaz  
F Fer à souder à gaz  
I Saldatore a gas  
E Microsoldador de butano portátil  
CN 瓦斯焊接工具



1300°C  
210-400°C  
20 ml  
25-80 W  
120 min

**YATO**  
YT-6705 25-80 12/72

GB Soldering iron set  
D Gasöko ben saz  
PL uownica azowa z akcesoriami  
RUS Газовый паяльный набор  
CZ Plynova pájka souprava  
H Gáz forrasztópáka készletek

RO Set ciocan de lipit cu gaz  
F Fer à souder à gaz  
I Saldatore a gas  
E Soldador a gas con accesorios  
CN 自动点火多功能瓦斯组套

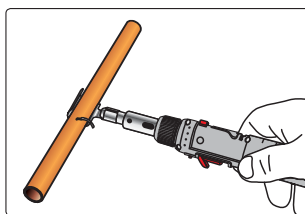

7 PCS  
30-125 W  
30 ml  
75 min  
GAS GAZ  
PIEZO  
LOCK BLOKADA  
BUTANE lighter gas  
BUTAN (gaz do zapalniczki)  
PROPANE-BUTANE lighter gas  
PROPAN-BUTAN (gaz do zapalniczki)  
CHILD PROTECTION  
ZABEZPECZENIE  
PRZED DZIECIAMI

- SOLDERING IRON**  
LUTOWNICA 450°C
- HOT AIR GUN**  
OPALARKA 600°C
- TORCH**  
PALNIK 1300°C

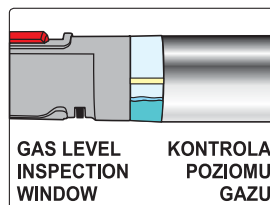

**YATO**  
YT-36706 30-125 6

GB Bu ane so derin oo RO Surube ni a sudura cu az  
D Gas o ko ben F Fer à souder à gaz  
PL u ownica azowa I Sa da ore a as  
RUS Паяльник газовый E Microso dador  
CZ Plynová pájka de butano portátil  
H Forrasztópisztoly ceruza CN 瓦斯焊接工具  
bután gáz üzemű

PIEZO ELECTRIC 1300°C 250-550°C 38 ml 30-125 W 200 min



SLIDING CARD

**YATO**  
YT-6706 30-125 12/48

GB So derin oo 3 in 1 F Fer à souder à gaz  
D Gas o ko ben 3 in 1 I Sa da ore a as  
PL u ownica azowa 3 w 1 E So dador de as 3 in 1  
RUS Газовый паяльник 3-в-1 CN 瓦斯焊接工具  
CZ Plynová pájka 3 in 1  
H Gaz-forrasztópaka 3 in 1  
RO Ciocan de lipit cu gaz 3 in 1

PIEZO 30-70 W 12 ml 60 min GAS GAZ LOCK BLOKADA BUTANE lighter gas BUTAN (gas de zapalnică) PROPANE-BUTANE lighter gas PROPAN-BUTAN (gas de zapalnică) CHILD PROTECTION ZABEZPEČENIE PŘED DĚTMI



SOLDERING IRON 350°C  
LUTOWNICA  
HOT AIR GUN 550°C  
OPALARKA  
TORCH 1300°C  
PALNIK

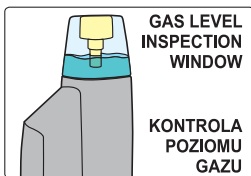

SLIDING CARD

**YATO**  
YT-36704 30-70 12/72

GB Gas b ow orch RO Arzător de gaz  
D ö brenner F Bru eur à az  
PL Pa nik azow I Sa da ore brucia ore a as  
RUS Газовая горелка E Soplete de gas  
CZ Plynový hořák CN 火焰枪  
H Gázégő

PIEZO 1.28 kW GAS GAZ AIR POWETRZE LOCK BLOKADA BUTANE BUTAN

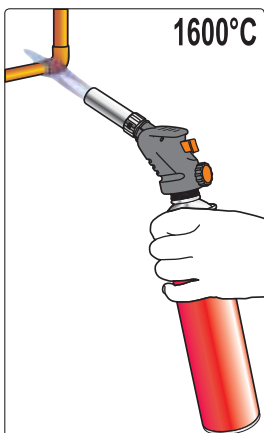

360°  
EURO TYPE EN417

SLIDING CARD

**YATO**  
YT-36709 1.28 6/12

GB So derin iron  
 D ò ko ben  
 PL Lutownica orogowa  
 RUS Электропаяльник  
 CZ Pájka odporová  
 H Forrasztópáka  
 RO Ciocan de lipit  
 F Fer à souder  
 I Sa da ore a s a no  
 E So dador de resis encia  
 CN 电烙铁



HANGING DISPLAY COLOR BOX



230V~50Hz

YATO	working temp. of soldering tip (°C)	dimensions of soldering tip (mm)	
YT-8271	30	400	ø3.8 x 70 16
YT-8272	60	500	ø6.0 x 78 16
YT-8273	80	520	ø6.8 x 64 16

GB Transformer so derin un  
 D Lötpestole  
 PL u ownica ransforma orowa  
 RUS Паяльник электрический  
 CZ Transformátorová páječka  
 H Forrasztópáka  
 RO Aparat de lipid letcon cu ransforma or  
 F Fer à souder  
 I Sa da ore is ane o  
 E So dador ransformador  
 CN 电烙铁



230V~50Hz

180 W



BMC & COLOR SLEEVE



YATO		
YT-8245	180	10

GB So derin s a ion  
 D ò s a ion  
 PL Stacja lutownicza  
 RUS Паяльная станция  
 CZ Letovací stanice  
 H Forrasztópáka állomás

RO Stație de lipit  
 F S a ion de souda e  
 I S azione di i a e di sa da ura  
 E s acción de so dadura  
 CN 数显焊台

230V~50Hz

48 W

150-450 °C

7.1 mm 65 mm

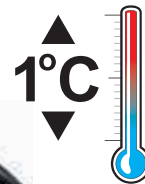

COLOR BOX



YATO		
YT-82455	48	4



GB Heißklebepistole  
D Heißklebepistole  
PL Pistolet do klejenia  
RUS Пистолет для клея  
CZ Pistole na lepení  
H Ragasztópisztoly  
RO Pistol pt. lipit  
F Pistolet à colle  
I Pistola a colla  
E Pistola de cola  
CN 热胶枪

230V~  
50Hz

35  
(400)  
W

∅  
11 mm



COLOR BOX

**YATO** 

YT-82401

35 (400)



12/24

GB Cordless glue gun  
D Heißklebepistole  
PL kumularowy pistolet do klejenia  
RUS Пистолет для клея  
CZ Pistole na lepení  
H Ragasztópisztoly  
RO Pistol pt. lipit  
F Pistolet à colle  
I Pistola a colla  
E Pistola de cola  
CN 热胶枪

7.4 V  
2.6 Ah  
Li-Ion

 8W

∅  
11 mm



DOUBLE BLISTER

**YATO** 

YT-82421

8



6/24

Memo

# 19

## Padlocks & lock cylinders Kłódki i wkładki do zamków



Brass padlocks  
Kłódki mosiężne

412



Lock cylinders  
Wkładki do zamków

413



Arbor padlocks  
Kłódki trzpieniowe

412



Brass lock cylinders

Wkładki mosiężne..... 413

Brass lock cylinders with knob



Wkładki mosiężne z gałką..... 413

GB Brass padlock  
 D orh n esch oss  
 PL Kl dka mosi zna  
 RUS Стержневой навесной латунный  
 CZ Z mek visac  mosazn y  
 H aka s r ar z  
 RO aca a ama  
 F Cadenas ai on nicke  
 I ucche o in o one  
 E Candado de a on  
 CN 铜挂锁

**4xT** **BRASS**  
 MOSIADZ



DOUBLE BLISTER



YATO 	L (mm)	
YT-6966	60	6/36

GB Arbor brass padlock  
 D orh n esch oss  
 PL Kl dka trzpieniowa  
 RUS Стержневой навесной замок чугунный  
 CZ Stavebn  visac  z mek  
 H ri s aka  
 RO Lac t  
 F Cadenas ai on acier rec an u aire  
 I ucche o re an o are  
 E Candado de mandri de hierro fundido cubier o  
 CN 挂锁

**4xT** **BRASS**  
 MOSIADZ



DOUBLE BLISTER



YATO 	L (mm)	
YT-6980	40	6/96
YT-6981	50	6/72
YT-6982	60	6/60
YT-6983	70	6/36
YT-6984	80	6/30
YT-6985	90	6/24

GB Arbor brass padlock  
 D orh n esch oss  
 PL Kl dka trzpieniowa  
 RUS Стержневой навесной замок чугунный  
 CZ Stavebn  visac  z mek  
 H ri s aka  
 RO Lac t  
 F Cadenas ai on rec an u aire nicke  
 I ucche o re an o are  
 E Candado de mandri de hierro fundido cubier o  
 CN 挂锁

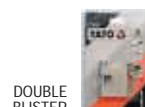
**4xT** **BRASS**  
 MOSIADZ



DOUBLE BLISTER

YATO 	L (mm)	
YT-6986	40	6/48
YT-6987	50	6/48
YT-6989	70	6/24

GB Lock cylinder  
D Schliesszylinder  
PL Wkładka do zamka  
RUS Замок цилиндрический  
CZ Vložka na zámek  
H Zárbe  
RO Yală pt. broască  
F Serrure à encas rer  
I Cilindro con pomolo  
E inserción de a ón  
CN 锁芯

BRASS  
MOSIADZ



GB Lock cylinder  
D Schliesszylinder  
PL Wkładka do zamka  
RUS Замок цилиндрический  
CZ Vložka na zámek  
H Zárbe  
RO Yală pt. broască  
F Serrure à encas rer  
I Cilindro con pomolo  
E inserción de a ón  
CN 锁芯

BRASS  
MOSIADZ



Lock cylinder received „Test Certificate”  
issued by Instytut Techniki Budowlanej

Wkładka posiada „Świadectwo Badań”  
wystawione przez Instytut Techniki Budowlanej

COLOR BOX  
& MESH  
PLASTIC TRAY



YATO	L (mm)	mm	
YT-69900	62	31/31	12/60
YT-69901	67	31/36	12/60
YT-69902	72	31/41	12/60
YT-69903	87	36/51	12/60

Lock cylinder received „Test Certificate”  
issued by Instytut Techniki Budowlanej

Wkładka posiada „Świadectwo Badań”  
wystawione przez Instytut Techniki Budowlanej

COLOR BOX  
& MESH  
PLASTIC TRAY



YATO	L (mm)	mm	
YT-69905	62	31/31	12/60
YT-69906	67	31/36	12/60
YT-69907	72	31/41	12/60
YT-69908	87	36/51	12/60

GB Lock cylinder  
D Schliesszylinder  
PL Wkładka do zamka  
RUS Замок цилиндрический  
CZ Vložka na zámek  
H Zárbe  
RO Yală pt. broască  
F Serrure à encas rer  
I Cilindro con pomolo  
E inserción de a ón  
CN 锁芯

BRASS  
MOSIADZ



GB Lock cylinder  
D Schliesszylinder  
PL Wkładka do zamka  
RUS Замок цилиндрический  
CZ Vložka na zámek  
H Zárbe  
RO Yală pt. broască  
F Serrure à encas rer  
I Cilindro con pomolo  
E inserción de a ón  
CN 锁芯

BRASS  
MOSIADZ



Lock cylinder received „Test Certificate”  
issued by Instytut Techniki Budowlanej

Wkładka posiada „Świadectwo Badań”  
wystawione przez Instytut Techniki Budowlanej

COLOR BOX  
& MESH  
PLASTIC TRAY



YATO	L (mm)	mm	
YT-69910	62	31/31	12/60
YT-69911	67	31/36	12/60
YT-69912	67	36/31	12/60
YT-69913	72	31/41	12/60
YT-69914	72	41/31	12/60

Lock cylinder received „Test Certificate”  
issued by Instytut Techniki Budowlanej

Wkładka posiada „Świadectwo Badań”  
wystawione przez Instytut Techniki Budowlanej

COLOR BOX  
& MESH  
PLASTIC TRAY



YATO	L (mm)	mm	
YT-69920	62	31/31	12/60
YT-69921	67	31/36	12/60
YT-69922	67	36/31	12/60
YT-69923	72	31/41	12/60
YT-69924	72	41/31	12/60

# 20

Accessories  
Akcesoria



Tool belts  
Pasy na narzędzia

416



Tool bags  
Torby narzędziowe

417



Tool pockets  
Kieszenie na narzędzia

416-417



- GB Heavy duty nail & tool pouch
- D Werkzeugreife mit Nägel- und Schraubenaschen
- PL Pas z kieszeniami na gwoździe i narzędzia
- RUS Ремень с сумками для гвоздей и инструментов
- CZ Pás na nářadí pětkapsový
- H Szeleszsámáróöv
- RO Centura portscule
- F Ceinture porte-outils clous
- I Cintura con tasche per chiodi e utensili
- E Cinturón porta herramientas accesorios varios
- CN 重型工具袋



**21**  
POCKETS  
KIESZENI

**120**  
cm

HEAVY  
DUTY  
NYLON

COLOR BOX



**COWHIDE BELT**



**YATO**

YT-7400



10

- GB Pouch belt
- D Grefwerkzeuge
- PL Pas na kieszenie na narzędzia
- RUS Пояс для карманов для инструмента
- CZ Opasek na monterské kapsáře
- H v ersz n hez
- RO Curea cu buzunar
- F Ceinture porte-outils
- I Cintura con le tasche porta utensili
- E Cinturón para bolsas de herramientas
- CN 工具腰带



HEADER  
CARD



**90-120**  
cm

HEAVY  
DUTY  
NYLON

**YATO**

YT-7409



50/100

- GB 8-pocket tool bag
- D Gürtelwerkzeugtasche mit 8 Fächern
- PL 8. kieszeniowa torba na narzędzia
- RUS Сумка - 8 карманов для инструмента
- CZ Kapsář na nářadí 8-kapsový
- H Szeleszsámáróersz n 8 zsebbe
- RO Geanta pt. scule 8 buzunare
- F Poche e à ou is
- I Borsa porta attrezzi con 8 tasche
- E Bolso para herramientas de 8 bolsillos
- CN 工具包

HEADER  
CARD



**8**  
POCKETS  
KIESZENI

HEAVY  
DUTY  
NYLON

- GB Universal cordless driver
- D Greasche für Kuschrauber
- PL Kieszeń na wiertarkę akumulatorową
- RUS Карман для аккумуляторной дрели
- CZ Kapsář za opasek na akuvrtáčku
- H Univerzális ar ersz n akkus csavabehatóhoz

- RO Suport universal pt. bormasina
- F Pochette à perceuse sans fil
- I Fondina per trapano a batteria
- E Bolsa porta taladradora de acumador
- CN 电钻通用挂袋

HEADER  
CARD



HEAVY  
DUTY  
NYLON



**YATO**

YT-7410



20/40

**YATO**

YT-7413



20/40

**YATO**

YT-7414



48/96

- GB Nail / tool pouch
- D Grewerkzeuge
- PL Kieszeń na gwoździe i narzędzia
- RUS Карман для гвоздей и инструментов
- CZ Kapsář na nářadí
- H Szeleszsámáróersz n
- RO Buzunar pt. scule / cuie
- F Poche e à ou is e crous
- I Tasche per chiodi e utensili
- E Bolsa porta herramientas accesorios varios
- CN 钉子袋

HEADER  
CARD



HEAVY  
DUTY  
NYLON



**YATO**

YT-7416



20/40

**YATO**

YT-7417



39/156





- GB Nail pocket + hammer loop  
D Hammer und Nähe-Greifschleife  
PL Kieszka z uchwytem na młotek  
RUS Карман-держатель для молотка  
CZ Kapsař za opasek na kladivo  
H Szeg tartó erszény kalapástartóval  
RO Suport pt. ciocan  
F Pochette à outils + porte-marteau  
I Tasca porta martello  
E Bolsa con el soporte para martillo  
CN 锤头钉子袋



HEAVY DUTY NYLON

HEADER CARD



**YATO** 

YT-7419



40/80

- GB Mobile phone pouch  
D Hand-Greifschleife  
PL Kieszka na telefon komórkowy  
RUS Карман для мобильного телефона  
CZ Pouzdro za opasek na mobilni telefon  
H Mobi telefon aró  
RO Suport pt. telefon  
F Pochette à téléphone portable  
I Tasca porta cellulare  
E Bolsa de teléfono móvili  
CN 手机袋



HEAVY DUTY NYLON

HEADER CARD



**YATO** 

YT-7420



27/54

- GB Tool bag  
D Werkzeugtasche  
PL Torba na narzędzia  
RUS Сумка для инструмента
- CZ Taška monšrská  
H Szerszámoska  
RO Geanta pt. scule  
F Sac à outils
- I Borsa per attrezzi  
E Bolsode herramientas  
CN 工具包

HEAVY DUTY NYLON



**YATO** 

YT-7430



12



16  
POCKETS  
KIESZENI

**YATO** 

YT-7433



12

- GB Seeube carrier  
D Werkzeugkoffer  
PL Walizka narzędziowa  
RUS Семодан для инструмента  
CZ Taška na nářadí  
H Szerszámtartó csővázas  
RO Geanta de otel pt. portbagaj  
F Sac à outils  
I Valigetta per attrezzi  
E Maletín de herramientas  
CN 钢管柄工具包

31  
POCKETS  
KIESZENI

HEAVY DUTY NYLON



**YATO** 

YT-7435



4

- GB Foldable chair with bag  
D Werkzeugtasche mit Klappstuhl  
PL Torba narzędziowa z krzeselkiem  
RUS Стул складной с сумкой для инструмента  
CZ Taška na nářadí se stojánkem  
H Sszecsukható szék arózsebbe  
RO Scaun raba abicuan a  
F Sac à outils + tabouret  
I Sedia pieghevole per borsa attrezzi  
E Bolsode herramientas con silla plegable  
CN 带包折叠椅

22  
POCKETS  
KIESZENI

HEAVY DUTY NYLON



**YATO** 

YT-7446



10

# 21

**Health & safety articles**  
**Artykuły BHP**



Safety glasses  
Okulary ochronne

420



Hearing protectors  
Nauszniki przeciwhałasowe

425



Safety goggles  
Gogle ochronne

421



Working shoes  
Buty robocze

426-427



Working gloves  
Rękawice robocze

421-422



Safety sandals

Sandały robocze..... 426

Low-cut safety shoes

Półbuty robocze..... 426

Middle-cut safety shoes

Trzewiki robocze..... 427

Knee pads  
Nakolanniki

422



Working clothes

Odzież robocza

428-429



Breathalyzers  
Alkomaty

422



Vests

Kamizelki..... 428

Working jackets

Bluzy i kurtki robocze..... 428

Working trousers

Spodnie robocze..... 429

Working overalls

Spodnie robocze ogrodniczki..... 429

Disposable dust masks  
Półmaski filtrujące

423-424



Ear plugs  
Zatyczki do uszu

424-425



GB Safe asses  
D Schu zbrle  
PL Oku ar ochronne

RUS Очки защитные открытые  
CZ Ochranné brýle  
H Védőszemüveg



RO Ochelari pt. protectie  
F Lunettes de protection  
I Occhiali protettivi

E Gafas protectoras  
CN 劳保眼镜

PAPER  
HANGING  
CARD





TYPE 90960 EN 166:2001 F

	
YT-7360	12/240





TYPE 9844 EN 166:2001 F

	
YT-7361	12/240



TYPE 91977 EN 166:2001 F

	
YT-7363	12/240



TYPE 91659 EN 166:2001 F

	
YT-7365	12/240



TYPE 91708 EN 166:2001 F

	
YT-7367	12/240



TYPE 91797 EN 166:2001 F

	
YT-7369	12/240



TYPE 91692 EN 166:2001 F

	
YT-7371	12/240



TYPE B524 EN 166:2001 F

	
YT-73631	12/300



TYPE B532 EN 166:2001 F

	
YT-73761	12/300



TYPE 9844 EN 166:2001 F

	
YT-7362	12/240



TYPE 91977 EN 166:2001 F

	
YT-7364	12/240





TYPE 91659 EN 166:2001 F

	
YT-7366	12/240





TYPE 91708 EN 166:2001 F

	
YT-7368	12/240



TYPE 91293 EN 166:2001 F

	
YT-7374	12/240



TYPE 91380 EN 166:2001 F

	
YT-7376	12/240



TYPE B517 EN 166:2001 F

	
YT-73641	12/300



TYP B510 N 166 2001 N 169 2002

	
YT-73744	12/300



TYPE B532 EN 166:2001 F

	
YT-73760	12/300

GB Safe glasses  
D Schutzbrille  
PL Gogle ochronne  
RUS Очки защитные  
CZ Ochranné brýle

H Védőszemüveg  
RO Ochelari pt. protectie  
F Lunette de protection  
de protection

I Occhiali protettivi  
a mascherina  
E Gafas protectoras  
CN 劳保眼镜

PAPER  
HANGING  
CARD



TYPE 2876 EN 166:2001 F

<b>YATO</b>	
YT-7377	12/120



TYPE #2769 EN 166:2001 F

<b>YATO</b>	
YT-7380	20/200



TYPE SG90B EN 166:2001 F

<b>YATO</b>	
YT-7381	20/200



TYP SG-60 N 166 2001 B

<b>YATO</b>	
YT-7382	10/100



TYP T 2015 N 166 2001 B

<b>YATO</b>	
YT-7383	10/100



TYP B608 N 166 2001 B

<b>YATO</b>	
YT-73801	10/100



TYP B421 N 166 2001 B

<b>YATO</b>	
YT-73830	10/100

GB work gloves  
D Arbeitshandschuh  
PL Rękawice robocze  
RUS Рабочие перчатки  
CZ Pracovní rukavice  
H Védőkesztyű  
RO Mănuși de lucru  
F Gants de travail  
I Guanti da lavoro  
E Guantes de piel  
CN 劳保手套



<b>YATO</b>	size / rozmiar	
YT-7470	10	50/100



PAPER  
HEADER



<b>YATO</b>	size / rozmiar	
YT-7472	10	50/100



<b>YATO</b>	size / rozmiar	
YT-7473	10	50/100



<b>YATO</b>	size / rozmiar	
YT-7474	10	50/100

GB orkin oves  
 D rbei shandschuh  
 PL Rękawice robocze  
 RUS Рабочие перчатки  
 CZ Pracovní rukavice  
 H Védőkesztyű  
 RO Mănuși de lucru  
 F Gan s de ravai  
 I Guan i da avoro  
 E Guantes de piel  
 CN 劳保手套

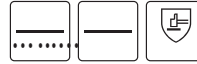

YATO	size / rozmiar	
YT-7480	9	12/120
YT-7481	10	12/120

YATO	size / rozmiar	
YT-7471	10	12/120

GB orkin oves  
 D rbei shandschuh  
 PL Rękawice robocze

RUS Рабочие перчатки  
 CZ Pracovní rukavice  
 H Védőkesztyű

RO Mănuși de lucru  
 F Gan s de ravai  
 I Guan i da avoro

E Guantes de piel  
 CN 劳保手套

PAPER HEADER



STRETCH  
 SPANDEX

PVC / PE  
 NEOPRENE

SPANDEX  
 NEOPRENE



YATO	size / rozmiar	
YT-7464	7 /	12/48
YT-7465	9 / XX	12/48

YATO	size / rozmiar	
YT-7467	9 / XX	12/72

YATO	size / rozmiar	
YT-7469	9 / XX	12/48

GB Gel knee pads  
 D Ge Knieschoner  
 PL Nakolanniki żelowe  
 RUS Гелевые наколенники  
 CZ Nákolenníky gelové  
 H Térdvédő zselés  
 RO Genunchiere  
 cu protectie de silicon

F Genouillères  
 à coussine s de e  
 I Protettore per ginocchio  
 E Pro ec ores  
 de gel para rodillas  
 CN 护膝



DISPLAY  
 COLOR BOX

GEL  
 SUPPORT



YATO	
YT-7460	12

YATO	
YT-7461	12

GB Disposable breathalyzer  
 D koho es er  
 PL Alkomat jednorazowy  
 RUS Алкотестер  
 CZ koho es er  
 H koho szonda  
 RO coo me ru

F co es  
 I i ome ro  
 monouso  
 E Alcoholímetro  
 CN 酒精测试仪



PLASTIC  
 BAG

DISPLAY  
 COLOR BOX

30 PCS



- results in min
- accurac
- meets NF and T V standards
- user friendl
- not includes carcinogenic potassium dichromate
- with two plastic mouthpieces

- test w min
- dokładność 99%
- spełnia normy NF i TÜV
- prosty w obsłudze
- nie zawiera rakotwórczego dichromianu potasu
- z dwoma plastikowymi ustnikami

YATO	
YT-73310	900

GB Disposable dust masks  
D emschu zmaske  
PL Półmaski filtrujące jednorazowe  
RUS Респиратор противопылевой  
одноразовый  
CZ Protiprašná maska  
H Eldobható porvédőmaszk  
RO Masca prař cu valva  
F Demi-masques de filtration  
I Maschera filtra polvere  
E Mascari a desechab e  
para protecci3n contra polvo  
CN 防尘面罩

**3**  
PCS

FFP1 NR



POLYBAG  
WITH HEADER



**YATO**  
YT-7485 25/100

GB Disposable dust masks with valve  
D emschu zmaske mi en i  
PL Półmaski filtrujące jednorazowe  
z zaworem  
RUS Респиратор противопылевой  
одноразовый с клапаном  
CZ Protiprašná maska s ventilem  
H Eldobható porvédőmaszk, szelepes  
RO Masca prař cu valva  
F Demi-masques de filtration  
I Maschera respiratoria con valvola  
di espirazione  
E Mascarilla desechable para  
protecci3n contra polvo  
CN 带阀防尘面罩

**3**  
PCS

FFP1 NR



POLYBAG  
WITH HEADER



**YATO**  
YT-7486 25/100

GB Disposable dust masks with valve  
D emschu zmaske mi en i  
PL Półmaski filtrujące jednorazowe  
z zaworem  
RUS Респиратор противопылевой  
одноразовый с клапаном  
CZ Protiprašná maska s ventilem  
H Eldobható porvédőmaszk, szelepes  
RO Masca prař cu valva  
F Demi-masques de filtration  
I Maschera respiratoria con valvola  
di espirazione  
E Mascarilla desechable para  
protecci3n contra polvo  
CN 带阀防尘面罩

**3**  
PCS

FFP1 NR



POLYBAG  
WITH HEADER



**YATO**  
YT-7488 25/100

GB Disposable dust masks with valve  
D emschu zmaske mi en i  
PL Półmaski filtrujące jednorazowe  
z zaworem  
RUS Респиратор противопылевой  
одноразовый с клапаном  
CZ Protiprašná maska s ventilem  
H Eldobható porvédőmaszk, szelepes  
RO Masca prař cu valva  
F Demi-masques de filtration  
I Maschera respiratoria con valvola  
di espirazione  
E Mascarilla desechable para  
protecci3n contra polvo  
CN 带阀防尘面罩

**500**  
PCS

FFP1 NR



POLYBAG 500 PCS  
WHITE CARTON BOX  
& COLOR LABEL

**YATO**  
YT-74947 1

GB Disposable dust masks with valve  
D emschu zmaske mi en i  
PL Półmaski filtrujące jednorazowe  
z zaworem  
RUS Респиратор противопылевой  
одноразовый с клапаном  
CZ Protiprašná maska s ventilem  
H Eldobható porvédőmaszk, szelepes  
RO Masca prař cu valva  
F Demi-masques de filtration  
I Maschera respiratoria con valvola  
di espirazione  
E Mascarilla desechable para  
protecci3n contra polvo  
CN 带阀防尘面罩

**500**  
PCS

FFP1 NR



POLYBAG 500 PCS  
WHITE CARTON BOX  
& COLOR LABEL

**YATO**  
YT-74951 1

GB Disposable dust masks with valve  
D emschu zmaske mi en i  
PL Półmaski filtrujące jednorazowe  
z zaworem  
RUS Респиратор противопылевой  
одноразовый с клапаном  
CZ Protiprašná maska s ventilem  
H Eldobható porvédőmaszk, szelepes  
RO Masca prař cu valva  
F Demi-masques de filtration  
I Maschera respiratoria con valvola  
di espirazione  
E Mascarilla desechable para  
protecci3n contra polvo  
CN 带阀防尘面罩

**3**  
PCS

FFP2 NR



POLYBAG  
WITH HEADER



**YATO**  
YT-7492 15/60

GB Disposable dust masks with valve  
 D emschu zmaske mi en i  
 PL Półmaski filtrujące jednorazowe z zaworem  
 RUS Респиратор противопылевой одноразовый с клапаном  
 CZ Protiprašná maska s ventilem  
 H Eldobható porvédőmaszk, szelepes  
 RO Masca prař cu valva  
 F Demi-masques de filtration  
 I Maschera respiratoria con valvola di espirazione  
 E Mascarilla desechable para protecci3n contra polvo  
 CN 带阀防尘面罩

500  
PCS

FFP2 NR



POLYBAG → 500 PCS WHITE CARTON BOX & COLOR LABEL

<b>YATO</b>		
YT-74954		1

GB Disposable dust masks with valve  
 D emschu zmaske mi en i  
 PL Półmaski filtrujące jednorazowe z zaworem  
 RUS Респиратор противопылевой одноразовый с клапаном  
 CZ Protiprašná maska s ventilem  
 H Eldobható porvédőmaszk, szelepes  
 RO Masca prař cu valva  
 F Demi-masques de filtration  
 I Maschera respiratoria con valvola di espirazione  
 E Mascarilla desechable para protecci3n contra polvo  
 CN 带阀防尘面罩

500  
PCS

FFP2 NR



POLYBAG → 500 PCS WHITE CARTON BOX & COLOR LABEL

<b>YATO</b>		
YT-74956		1

GB Disposable dust masks with valve  
 D emschu zmaske mi en i  
 PL Półmaski filtrujące jednorazowe z zaworem  
 RUS Респиратор противопылевой одноразовый с клапаном  
 CZ Protiprašná maska s ventilem  
 H Eldobható porvédőmaszk, szelepes  
 RO Masca prař cu valva  
 F Demi-masques de filtration  
 I Maschera respiratoria con valvola di espirazione  
 E Mascarilla desechable para protecci3n contra polvo  
 CN 带阀防尘面罩

500  
PCS

FFP3 NR



POLYBAG → 500 PCS WHITE CARTON BOX & COLOR LABEL

<b>YATO</b>		
YT-74959		1

GB Ear plugs  
 D Geh3rschu z  
 PL Za czki do uszu

RUS Средства защиты слуха  
 CZ Chrániče sluchu  
 H F3lvéd3t

RO n ifoane  
 F Bouchons an i-brui  
 I Tappi per orecchie

E Pro ec ores de a vis a  
 CN 耳塞

SNR  
34 dB  
5  
PAIRS  
PAR



POLYBAG WITH HEADER



<b>YATO</b>	size / rozmiar (mm)	pairs / pary	
YT-7451	7-12	5	25/500

SNR  
28 dB  
5  
PAIRS  
PAR



POLYBAG WITH HEADER



<b>YATO</b>	size / rozmiar (mm)	pairs / pary	
YT-7453	8-13	5	25/500

SNR  
22 dB  
5  
PAIRS  
PAR



POLYBAG WITH HEADER



<b>YATO</b>	size / rozmiar (mm)	pairs / pary	
YT-7455	8-12	5	25/500

SNR  
33 dB  
100  
PAIRS  
PAR



POLYBAG

WHITE CARTON BOX & COLOR LABEL



100 PCS



<b>YATO</b>	size / rozmiar (mm)	pairs / pary	
YT-7450	7-12	100	20

SNR  
28 dB  
100  
PAIRS  
PAR



POLYBAG

WHITE CARTON BOX & COLOR LABEL



100 PCS



<b>YATO</b>	size / rozmiar (mm)	pairs / pary	
YT-7452	8-13	100	20

SNR  
22 dB  
50  
PAIRS  
PAR



POLYBAG

WHITE CARTON BOX & COLOR LABEL



50 PCS



<b>YATO</b>	size / rozmiar (mm)	pairs / pary	
YT-7454	8-12	50	20

SNR  
34 dB  
200  
PAIRS  
PAR



POLYBAG

DISPLAY COLOR BOX



200 PCS



<b>YATO</b>	size / rozmiar (mm)	pairs / pary	
YT-74510	7-12	200	20

GB Ear plugs  
 D Geh3rschu z  
 PL Za czki do uszu na sznurku

RUS Средства защиты слуха  
 CZ Chrániče sluchu  
 H F3lvéd3t  
 RO n ifoane

F Bouchons an i-brui  
 I Tappi per orecchie  
 E Pro ec ores de a vis a  
 CN 耳塞

SNR  
28 dB



POLYBAG

WHITE CARTON BOX & COLOR LABEL



50 PCS



<b>YATO</b>	size / rozmiar (mm)	pairs / pary	
YT-7456	8-10	50	20



- GB Ear plugs
- D Gehörschu z
- PL Zatyczki do uszu na pałąku
- RUS Средства защиты слуха
- CZ Chráněče sluchu
- H Fülvédőt
- RO înifoane
- F Casque anibrui avec bouchons
- I Tappi per orecchie aurico ari
- E Pro ec ores de a vis a
- CN 耳塞





**SNR**  
21 dB





**SNR**  
26 dB

POLYBAG  
WITH  
HEADER



<b>YATO</b> 	
YT-7458	25/500

<b>YATO</b> 	
YT-7459	25/500

- GB Hearing protectors
- D Gehörschu z
- PL Nauszniki przeciwhałasowe
- RUS Средства защиты слуха
- CZ Chráněče sluchu
- H Fülvédőt
- RO înifoane
- F Casque anibrui
- I Cuffie antirumore
- E Pro ec ores de a vis a
- CN 耳罩



**SNR**  
26 dB

POLYBAG  
WITH HEADER



<b>YATO</b> 	
YT-7462	40



**SNR**  
26 dB



**SNR**  
27 dB

<b>YATO</b> 	
YT-7463	20

<b>YATO</b> 	
YT-74621	60

GB Safe sanda s  
D rbei sha bschuhe  
PL Sandały robocze  
RUS Полуботинки рабочие

CZ Pracovní polobotky  
H Munkavédelmi félcipő  
RO Papuc de lucru  
F Sanda de de s curi

I Sanda o da avoro  
E Zapato de trabajo  
CN 劳保鞋

RED CARTON BOX  
& COLOR LABEL



**SEGURA**

INSOLE & MESH  
COATED EVA  
WKŁADKA  
I WYŚCIÓŁKA  
Z MATERIAŁU  
EVA



COMPOSITE  
TOE CUP  
KOMPOZYTOWY  
NOSEK



SHOCK ABSORBER  
AMORTYZATOR  
DRGAŃ

PU OVERCUP  
PODESZWA  
Z POLIURETANU  
Z NOSKIEM

YATO	size / rozmiar	
YT-80460	36	10
YT-80461	37	10
YT-80462	38	10
YT-80463	39	10
YT-80464	40	10
YT-80465	41	10
YT-80466	42	10
YT-80467	43	10
YT-80468	44	10
YT-80469	45	10
YT-80470	46	10
YT-80471	47	10

GB ow-cu safe shoes  
D rbei sha bschuhe  
PL Półbuty robocze  
RUS Полуботинки рабочие

CZ Pracovní polobotky  
H Munkavédelmi félcipő  
RO Papuc de lucru  
F Chaussure de s curi

I Scarpe da lavoro  
E Zapato de trabajo  
CN 劳保鞋

RED CARTON BOX  
& COLOR LABEL



**PUNO**

INSOLE & MESH  
COATED EVA  
WKŁADKA  
I WYŚCIÓŁKA  
Z MATERIAŁU  
EVA



STALOWY NOSEK  
STEEL TOE CAP  
PU SOLE  
PODESZWA  
Z POLIURETANU



SHOCK ABSORBER  
AMORTYZATOR  
DRGAŃ



INSOLE & MESH  
COATED EVA  
WKŁADKA  
I WYŚCIÓŁKA  
Z MATERIAŁU  
EVA



STALOWY NOSEK  
STEEL TOE CAP  
PU SOLE  
PODESZWA  
Z POLIURETANU



SHOCK ABSORBER  
AMORTYZATOR  
DRGAŃ



YATO	size / rozmiar	
YT-80521	39	10
YT-80522	40	10
YT-80523	41	10
YT-80524	42	10
YT-80525	43	10
YT-80526	44	10
YT-80527	45	10
YT-80528	46	10
YT-80529	47	10

YATO	size / rozmiar	
YT-80572	39	10
YT-80573	40	10
YT-80574	41	10
YT-80575	42	10
YT-80576	43	10
YT-80577	44	10
YT-80578	45	10
YT-80579	46	10
YT-80580	47	10

INSOLE & MESH  
COATED EVA  
WKŁADKA  
I WYŚCIÓŁKA  
Z MATERIAŁU  
EVA

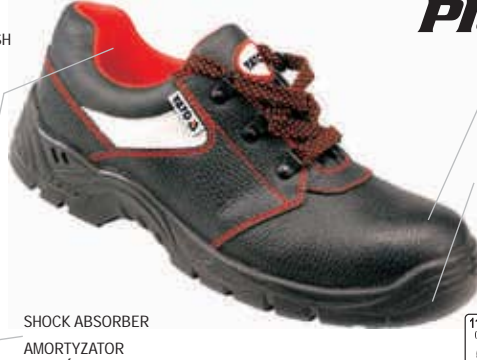

STALOWY NOSEK  
STEEL TOE CAP  
PU SOLE  
PODESZWA  
Z POLIURETANU



SHOCK ABSORBER  
AMORTYZATOR  
DRGAŃ



INSOLE & MESH  
COATED EVA  
WKŁADKA  
I WYŚCIÓŁKA  
Z MATERIAŁU  
EVA



STALOWY NOSEK  
STEEL TOE CAP  
PU SOLE  
PODESZWA  
Z POLIURETANU



SHOCK ABSORBER  
AMORTYZATOR  
DRGAŃ



YATO	size / rozmiar	
YT-80552	39	10
YT-80553	40	10
YT-80554	41	10
YT-80555	42	10
YT-80556	43	10
YT-80557	44	10
YT-80558	45	10
YT-80559	46	10
YT-80560	47	10

YATO	size / rozmiar	
YT-80583	39	10
YT-80584	40	10
YT-80585	41	10
YT-80586	42	10
YT-80587	43	10
YT-80588	44	10
YT-80589	45	10
YT-80590	46	10
YT-80591	47	10

GB Middle-cut safety shoes  
D Mittel- und Sicherheitsschuhe  
PL Trzewiki robocze  
RUS Ботинки рабочие

CZ Pracovní boty šněrovací  
H Munkavélműlakkal  
RO Pantofle de lucru  
F Chaussure de sécurité

I Scarpe da lavoro  
E Calzado de trabajo  
CN 劳保鞋

RED CARTON BOX  
& COLOR LABEL



INSOLE & MESH  
COATED EVA  
WKŁADKA  
I WYSIÓŁKA  
Z MATERIAŁU  
EVA



**TRAT**

INSOLE & MESH  
COATED EVA  
WKŁADKA  
I WYSIÓŁKA  
Z MATERIAŁU  
EVA



**TABAR**



SHOCK ABSORBER  
AMORTYZATOR  
DRGAŃ

STEEL TOE CAP  
STALOWY NOSEK

PU SOLE  
PODESZWA  
Z POLIURETANU



SHOCK ABSORBER  
AMORTYZATOR  
DRGAŃ

STEEL TOE CAP  
STALOWY NOSEK

PU SOLE  
PODESZWA  
Z POLIURETANU



YATO	size / rozmiar	
YT-80733	39	10
YT-80734	40	10
YT-80735	41	10
YT-80736	42	10
YT-80737	43	10
YT-80738	44	10
YT-80739	45	10
YT-80740	46	10
YT-80741	47	10

YATO	size / rozmiar	
YT-80761	39	10
YT-80762	40	10
YT-80763	41	10
YT-80764	42	10
YT-80765	43	10
YT-80766	44	10
YT-80767	45	10
YT-80768	46	10
YT-80769	47	10

INSOLE & MESH  
COATED EVA  
WKŁADKA  
I WYSIÓŁKA  
Z MATERIAŁU  
EVA



**TENDA**

INSOLE & MESH  
COATED EVA  
WKŁADKA  
I WYSIÓŁKA  
Z MATERIAŁU  
EVA



**TEZU**



SHOCK ABSORBER  
AMORTYZATOR  
DRGAŃ

STEEL TOE CAP  
STALOWY NOSEK

PU OVERCUP  
PODESZWA  
Z POLIURETANU  
Z NOSKIEM

PU SOLE  
PODESZWA  
Z POLIURETANU



SHOCK ABSORBER  
AMORTYZATOR  
DRGAŃ

STEEL TOE CAP  
STALOWY NOSEK

PU SOLE  
PODESZWA  
Z POLIURETANU



YATO	size / rozmiar	
YT-80852	39	10
YT-80853	40	10
YT-80854	41	10
YT-80855	42	10
YT-80856	43	10
YT-80857	44	10
YT-80858	45	10
YT-80859	46	10
YT-80860	47	10

YATO	size / rozmiar	
YT-80841	39	10
YT-80842	40	10
YT-80843	41	10
YT-80844	42	10
YT-80845	43	10
YT-80846	44	10
YT-80847	45	10
YT-80848	46	10
YT-80849	47	10

INSOLE & MESH  
COATED EVA  
WKŁADKA  
I WYSIÓŁKA  
Z MATERIAŁU  
EVA



**TOLU**

INSOLE & MESH  
COATED EVA  
WKŁADKA  
I WYSIÓŁKA  
Z MATERIAŁU  
EVA



**TWER**



SHOCK ABSORBER  
AMORTYZATOR  
DRGAŃ

STEEL TOE CAP  
STALOWY NOSEK

PU SOLE  
PODESZWA  
Z POLIURETANU



SHOCK ABSORBER  
AMORTYZATOR  
DRGAŃ

STEEL TOE CAP  
STALOWY NOSEK

PU SOLE  
PODESZWA  
Z POLIURETANU



YATO	size / rozmiar	
YT-80794	39	10
YT-80795	40	10
YT-80796	41	10
YT-80797	42	10
YT-80798	43	10
YT-80799	44	10
YT-80800	45	10
YT-80801	46	10
YT-80802	47	10

YATO	size / rozmiar	
YT-80783	39	10
YT-80784	40	10
YT-80785	41	10
YT-80786	42	10
YT-80787	43	10
YT-80788	44	10
YT-80789	45	10
YT-80790	46	10
YT-80791	47	10

GB nsu a ed ves  
 D Gepolsterte Weste  
 PL Bezrękawnik ocieplany  
 RUS Утепленный жилет  
 CZ es a  
 H B e m e n  
 RO Vestă vătuită  
 F Gi e m a e ass  
 I Gi e imbo i o  
 E Cha eco aco chado  
 CN 绝缘背心





100% POLYESTER  
 PVC COATED  
 100% POLIESTER  
 POWLOKA PVC

POLYBAG



**DUGO**

YATO 	size / rozmiar	
YT-80355	S	20
YT-80356	M	20
YT-80357		20
YT-80358	X	20
YT-80359	XX	20

GB Fleece jacket  
 D Fleece-Jacke  
 PL Bluza polarowa  
 RUS Флисовая кофта  
 CZ Fleecová bunda  
 H Fleece dzseki  
 RO Bluză polar  
 F Veste polaire  
 I Giacca in pile  
 E Chaqueta polar  
 CN 摇粒绒夹克





**POLAR**  
 350g/m<sup>2</sup>

POLYBAG



**DURANGO BLACK**

YATO 	size / rozmiar	
YT-80360	S	8
YT-80361	M	8
YT-80362		8
YT-80363	X	8
YT-80364	XX	8

GB Fleece jacket  
 D Fleece-Jacke  
 PL Bluză polarowă  
 RUS Флисовая кофта  
 CZ Fleecová bunda  
 H Fleece dzseki  
 RO Bluză polar  
 F Veste polaire  
 I Giacca in pile  
 E Chaqueta polar  
 CN 摇粒绒夹克





**POLAR**  
 350g/m<sup>2</sup>

POLYBAG



**DURANGO GREY**

YATO 	size / rozmiar	
YT-80365	S	8
YT-80366	M	8
YT-80367		8
YT-80368	X	8
YT-80369	XX	8

GB Softshell jacket  
 D Sof she -Jacke  
 PL Kur ka sof she  
 RUS Softshell куртка  
 CZ Sof she ová bunda  
 H Sof she dzseki  
 RO Jache a sof she  
 F es e sof she  
 I Giacca sof she  
 E Cha ue a sof she  
 CN 冲锋夹克





98% POLYESTER  
 4% SPANDEX  
 98% POLIESTER  
 4% SPANDEX

POLYBAG



**DEZ**

YATO 	size / rozmiar	
YT-80390	S	10
YT-80391	M	10
YT-80392		10
YT-80393	X	10
YT-80394	XX	10



GB Jacke  
 D Jacke  
 PL Kur ka  
 RUS Куртка  
 CZ Bunda  
 H Dzseki  
 RO Jache a  
 F es e  
 I Giacca  
 E Cha ue a  
 CN 夹克



100% POLYESTER  
 PVC COATED  
 100% POLIESTER  
 POWLOKA PVC



**POLAR**  
 220g/m<sup>2</sup>

**3in1**  
**3w1**

POLYBAG



**DORRA**

YATO 	size / rozmiar	
YT-80380	S	10
YT-80381	M	10
YT-80382		10
YT-80383	X	10
YT-80384	XX	10

- GB Working jacket
- D Arbeitsjacke
- PL B uza robocza
- RUS Рабочая рубашка
- CZ Pracovní blůza
- H Munkaruha felső
- RO Bluză de lucru
- F Bouson de travail
- I Felpa da lavoro
- E Blusa de trabajo
- CN 工作服





65% POLYESTER  
35% COTTON  
65% POLYESTER  
35% BAWELNA

POLYBAG



## DUERO

YATO 	size / rozmiar	
YT-8020	S	20
YT-8021	M	20
YT-8022		20
YT-8023	X	20
YT-8024	XX	20

- GB orkin rousers
- D rbei shosen
- PL Spodnie robocze
- RUS Рабочие брюки
- CZ Pracovní kalhoty
- H Munkaruha nadrá
- RO Pan a oni de ucru
- F Pan a on de travail
- I Pan a one da lavoro
- E Pantalón de trabajo
- CN 工作服





65% POLYESTER  
35% COTTON  
65% POLYESTER  
35% BAWELNA

POLYBAG



## DUERO

YATO 	size / rozmiar	
YT-8025	S	20
YT-8026	M	20
YT-8027		20
YT-8028	X	20
YT-8029	XX	20

- GB orkin overalls
- D rbei shosen Gärnerin
- PL Spodnie robocze ogrodniczki
- RUS Рабочий полукombineзон
- CZ Pracovní kalhoty lačlové
- H Ker sznadrá
- RO Pantaloni de lucru grădină
- F Salopette de travail
- I Salopette da lavoro
- E Pantalón de trabajo tipo jardinero
- CN 工作服





65% POLYESTER  
35% COTTON  
65% POLYESTER  
35% BAWELNA

POLYBAG



## DUERO

YATO 	size / rozmiar	
YT-8030	S	20
YT-8031	M	20
YT-8032		20
YT-8033	X	20
YT-8034	XX	20

# 22

## Electric products Artykuły elektryczne



LED bulbs  
Żarówki LED

432



LED workshop lightning  
Oświetlenie warsztatowe LED

435-437



LED lamps  
Reflektory LED

433-434







Extension cords  
Przedłużacze elektryczne

438-439



GB D i h b u b  
 D LED- Glühlampe  
 PL Żarówka LED  
 RUS Светодиодная лампочка  
 CZ LED žárovka  
 H LED égő  
 RO Bec D  
 F Ampoule LED  
 I Lampadina LED  
 E Bombi a D  
 CN LED灯泡



 **7W** **10W** **12W**  
**590 lm** **720 lm** **950 W**  
 **40W**  **60W**  **75W**  
 REPLACEMENT ODPOWIEDNIK  
 REPLACEMENT ODPOWIEDNIK  
 REPLACEMENT ODPOWIEDNIK  
**3000K** **230V~**  
**CR>80** **50Hz**  



PVC COLOR BOX

YATO	m	replacement / odpowiednik ( )	
YT-81851	7	590	40 50/100
YT-81852	10	720	60 50/100
YT-81853	12	950	75 50/100

GB D i h b u b  
 D LED- Glühlampe  
 PL Żarówka LED  
 RUS Светодиодная лампочка  
 CZ LED žárovka  
 H LED égő  
 RO Bec D  
 F Ampoule LED  
 I Lampadina LED  
 E Bombi a D  
 CN LED灯泡



 **5W** **250 lm**  
**25W** **3000K**  
 REPLACEMENT ODPOWIEDNIK  
**CR>80**  
**WHITE WARM** **230V~**  
**BIAŁY CIEPŁY** **50Hz**  



PVC COLOR BOX

YATO	m	replacement / odpowiednik ( )	
YT-81861	5	250	25 50/200

GB D i h b u b  
 D LED- Glühlampe  
 PL Żarówka LED  
 RUS Светодиодная лампочка  
 CZ LED žárovka  
 H LED égő  
 RO Bec D  
 F Ampoule LED  
 I Lampadina LED  
 E Bombi a D  
 CN LED灯泡



 **5W** **265 lm**  
**25W** **3000K**  
 REPLACEMENT ODPOWIEDNIK  
**CR>80**  
**WHITE WARM** **12V**  
**BIAŁY CIEPŁY** **AC/DC**  



PVC COLOR BOX

YATO	m	replacement / odpowiednik ( )	
YT-81862	5	265	25 50/200

GB D i h b u b  
 D LED- Glühlampe  
 PL Żarówka LED  
 RUS Светодиодная лампочка  
 CZ LED žárovka  
 H LED égő  
 RO Bec D  
 F Ampoule LED  
 I Lampadina LED  
 E Bombi a D  
 CN LED灯泡

 **3W** **160 lm**  
**20W** **3000K**  
 REPLACEMENT ODPOWIEDNIK  
**CR>80**  
**WHITE WARM** **230V~**  
**BIAŁY CIEPŁY** **50Hz**  



PVC COLOR BOX

YATO	m	replacement / odpowiednik ( )	
YT-81871	3	160	20 50/100



GB LED lamp  
D Diodescheinwerfer  
PL Reflektor diodowy  
RUS Светодиодный прожектор  
CZ LED reflektor  
H Diódás reflektor  
RO Reflector diodă  
F Projecteur LED  
I Faretto LED  
E Reflector de diodos  
CN 工作灯

**10W** **6000°K** ~220-240V  
50Hz  
**700 lm** **20000 h** **IP65**

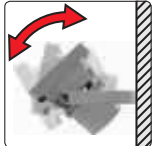
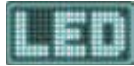

**YATO**  
YT-81800 18

GB LED lamp with motion detector  
D Diodescheinwerfer mi Bewe un sme der  
PL Reflektor diodowy z czujnikiem ruchu  
RUS Светодиодный прожектор с датчиком движения  
CZ LED reflektor se snímačem pohybu  
H Diódás reflektor mozgásérzékelővel  
RO Reflector diodă cu senzor de mișcare  
F Projecteur LED avec détecteur de mouvement  
I Faretto LED con sensore movimento  
E Reflector de diodos con sensor de movimiento  
CN 工作灯

**10W** **6000°K** ~220-240V  
50Hz  
**700 lm** **20000 h** **IP44**



**YATO**  
YT-81801 18

GB Portable LED lamp  
D Diodescheinwerfer mi Tra eb e  
PL Reflektor diodowy przenośny  
RUS Светодиодный прожектор переносной  
CZ LED reflektor přenosný  
H Hordozható, diódás reflektor  
RO Reflector diodă portabil  
F Projecteur LED  
I Faretto LED portatilea  
E Reflector de diodos portátil  
CN 手提式工作灯

**10W** **6000°K** ~220-240V  
50Hz  
**700 lm** **20000 h** **IP65**

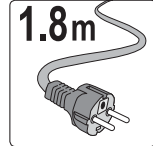

**YATO**  
YT-81802 12

GB LED lamp  
D Diodescheinwerfer  
PL Reflektor diodowy  
RUS Светодиодный прожектор  
CZ LED reflektor  
H Diódás reflektor  
RO Reflector diodă  
F Projecteur LED  
I Faretto LED  
E Reflector de diodos  
CN 工作灯

**30W** **6000°K** ~220-240V  
50Hz  
**2100 lm** **20000 h** **IP65**

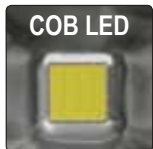
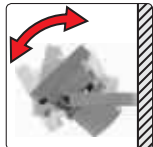

**YATO**  
YT-81803 6

GB LED lamp with motion detector  
D Diodescheinwerfer mi Bewe un sme der  
PL Reflektor diodowy z czujnikiem ruchu  
RUS Светодиодный прожектор с датчиком движения  
CZ LED reflektor se snímačem pohybu  
H Diódás reflektor mozgásérzékelővel  
RO Reflector diodă cu senzor de mișcare  
F Projecteur LED avec détecteur de mouvement  
I Faretto LED con sensore movimento  
E Reflector de diodos con sensor de movimiento  
CN 工作灯

**30W** **6000°K** ~220-240V  
50Hz  
**2100 lm** **20000 h** **IP44**

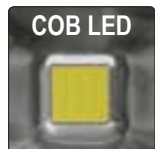

**YATO**  
YT-81804 6

GB Portable handle for LED floodlight  
D Tragbare Ständer für LED-Lampen  
PL Uchwyt do reflektora LED  
RUS Портативная подставка для светодиодных ламп  
CZ Přenosný stojan LED světlometů  
H Hordozható ó á ván D f n szóró  
RO Suport portabil faruri cu LED-uri  
F Poignée pour projecteur LED  
I Supporto portatile per faretto LED  
E Soporte portátil linterna LED  
CN 灯手柄

for / dla: YT-81803



WHITE CARTON BOX & COLOR LABEL

**YATO**  
YT-81805 8

GB LED lamp  
D Diodescheinwerfer  
PL Reflektor diodowy  
RUS Светодиодный прожектор  
CZ LED reflektor  
H Diódás reflektor  
RO Reflector diodă  
F Projecteur LED  
I Faretto LED  
E Reflector de diodos  
CN 工作灯

**50W** **3500 lm** **6000°K** ~220-240V  
50Hz  
**20000 h** **IP65**

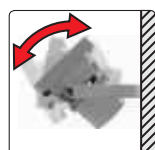

**YATO**  
YT-81806 3

- GB LED lamp
- D Diodescheinwerfer
- PL Reflektor diodowy
- RUS Светодиодный прожектор
- CZ LED reflektor
- H Diódás reflektor
- RO Reflector diodă
- F Projecteur LED
- I Faretto LED
- E Reflector de diodos
- CN 工作灯

COLOR BOX



<b>6W</b>	<b>6 LED</b>
~220-240V 50Hz	<b>510 lm</b>
HIGH POWER LED	30 000-50 000 h
<b>1W</b> DIODA DUZEJ MOCY	<b>IP54</b>



LOW ENERGY CONSUMPTION

NISKIE ZUZYCIE ENERGII

**YATO**

YT-81790 24

- GB LED lamp with motion detector
- D Diodescheinwerfer mi Bewe un sme der
- PL Reflektor diodowy z czujnikiem ruchu
- RUS Светодиодный прожектор с датчиком движения
- CZ LED reflektor se snímačem pohybu
- H Diódás reflektor mozgásérzékelővel
- RO Reflector diodă cu senzor de mișcare
- F Projecteur LED avec détecteur de mouvement
- I Faretto LED con sensore movimento
- E Reflector de diodos con sensor de movimien o
- CN 工作灯

COLOR BOX



<b>6W</b>	<b>6 LED</b>
~220-240V 50Hz	<b>510 lm</b>
HIGH POWER LED	30 000-50 000 h
<b>1W</b> DIODA DUZEJ MOCY	<b>IP44</b>



LOW ENERGY CONSUMPTION

NISKIE ZUZYCIE ENERGII

MOTION DETECTOR

CZUJNIK RUCHU

**YATO**

YT-81791 18

- GB Portable LED lamp
- D Diodescheinwerfer mi Tra eb e
- PL Reflektor diodowy przenośny
- RUS Светодиодный прожектор переносной
- CZ LED reflektor přenosný
- H Hordozható, diódás reflektor
- RO Reflector diodă portabil
- F Projecteur LED
- I Faretto LED portatilea
- E Reflector de diodos portátil
- CN 手提式工作灯

COLOR BOX



<b>6W</b>	<b>6 LED</b>
~220-240V 50Hz	<b>510 lm</b>
HIGH POWER LED	30 000-50 000 h
<b>1W</b> DIODA DUZEJ MOCY	<b>IP54</b>



LOW ENERGY CONSUMPTION

NISKIE ZUZYCIE ENERGII

**YATO**

YT-81792 12

- GB LED lamp
- D Diodescheinwerfer
- PL Reflektor diodowy
- RUS Светодиодный прожектор
- CZ LED reflektor
- H Diódás reflektor
- RO Reflector diodă
- F Projecteur LED
- I Faretto LED
- E Reflector de diodos
- CN 工作灯

COLOR BOX



<b>12W</b>	<b>12 LED</b>
~220-240V 50Hz	<b>1020 lm</b>
HIGH POWER LED	30 000-50 000 h
<b>1W</b> DIODA DUZEJ MOCY	<b>IP54</b>



LOW ENERGY CONSUMPTION

NISKIE ZUZYCIE ENERGII

**YATO**

YT-81793 16

- GB LED lamp with motion detector
- D Diodescheinwerfer mi Bewe un sme der
- PL Reflektor diodowy z czujnikiem ruchu
- RUS Светодиодный прожектор с датчиком движения
- CZ LED reflektor se snímačem pohybu
- H Diódás reflektor mozgásérzékelővel
- RO Reflector diodă cu senzor de mișcare
- F Projecteur LED avec d ec eur de mouvement
- I Faretto LED con sensore movimen o
- E Reflector de diodos con sensor de movimien o
- CN 工作灯

COLOR BOX



<b>12W</b>	<b>12 LED</b>
~220-240V 50Hz	<b>1020 lm</b>
HIGH POWER LED	30 000-50 000 h
<b>1W</b> DIODA DUZEJ MOCY	<b>IP44</b>



LOW ENERGY CONSUMPTION

NISKIE ZUZYCIE ENERGII

MOTION DETECTOR

CZUJNIK RUCHU

**YATO**

YT-81794 12

- GB Portable LED lamp
- D Diodescheinwerfer mi Tra eb e
- PL Reflektor diodowy przenośny
- RUS Светодиодный прожектор переносной
- CZ LED reflektor přenosný
- H Hordozható ó diódás reflektor
- RO Reflector diodă portabil
- F Projecteur LED
- I Faretto LED portatilea
- E Reflector de diodos portátil
- CN 手提式工作灯

COLOR BOX



<b>12W</b>	<b>12 LED</b>
~220-240V 50Hz	<b>1020 lm</b>
HIGH POWER LED	30 000-50 000 h
<b>1W</b> DIODA DUZEJ MOCY	<b>IP54</b>



LOW ENERGY CONSUMPTION

NISKIE ZUZYCIE ENERGII

**YATO**

YT-81795 8

GB Workshop LED battery lamp  
D D kku-hand euch e  
PL Diodowa lampa warsztatowa akumulatorowa  
RUS Аккумуляторный светодиодный  
светильник для мастерской  
CZ Ruční svítidla LED  
H Ledes szerelőlámpa címkéjű cikkek  
RO Lampa portabila cu acumulator leduri  
F Lampe baladeuse  
I Lampada per officina spaccata  
E in erna D recar ab e  
CN 可充裝駁釘腑



**YATO**  
YT-08502 12

**1+1 LED** **180 lm**  
**3.7V 3600mAh Li-ion** **230V~50Hz BATTERY CHARGER LADOWARKA**  
**CHARGING TIME CZAS LADOWANIA 4 h** **WORK TIME CZAS PRACY 3 h 2 LED**  
**HOOK HAK** **MAGNETIC**  
**LED**



GB Workshop LED battery lamp  
D D kku-hand euch e  
PL Diodowa lampa warsztatowa akumulatorowa  
RUS Аккумуляторный светодиодный  
светильник для мастерской  
CZ Ruční svítidla LED  
H Ledes szerelőlámpa címkéjű cikkek  
RO Lampa portabila cu acumulator leduri  
F Lampe néon  
I Lampada neon  
E in erna D recar ab e  
CN 可充裝駁釘腑



**YATO**  
YT-08561 20

**3+1 LED** **250 lm**  
**2 LIGHTING OPTIONS (OFFICE / WAREHOUSE)** **IP64**  
**3.7V 3600mAh Li-ion** **230V~50Hz BATTERY CHARGER LADOWARKA**  
**CHARGING TIME CZAS LADOWANIA 4.5 h** **WORK TIME CZAS PRACY 5 h 3 LED**  
**HOOK HAK** **MAGNETIC**  
**LED**



GB Workshop LED battery lamp  
D D kku-hand euch e  
PL Diodowa lampa warsztatowa akumulatorowa  
RUS Аккумуляторный светодиодный  
светильник для мастерской  
CZ Ruční svítidla LED  
H Ledes szerelőlámpa címkéjű cikkek  
RO Lampa portabila cu acumulator leduri  
F Lampe d'inspection  
I Torcia ispezione  
E in erna D recar ab e  
CN 可充裝駁釘腑



**YATO**  
YT-08514 12/72

**8 LED** **80 lm**  
**WORK TIME CZAS PRACY 20 h 8 LED** **1.5V 3x AAA**  
**LED**



GB Workshop LED battery lamp  
D D kku-hand euch e  
PL Diodowa lampa warsztatowa akumulatorowa  
RUS Аккумуляторный светодиодный  
светильник для мастерской  
CZ Ruční svítidla LED  
H Ledes szerelőlámpa címkéjű cikkek  
RO Lampa portabila cu acumulator leduri  
F Lampe baladeuse  
I Lampada per officina spaccata  
E in erna D recar ab e  
CN 可充裝駁釘腑



**YATO**  
YT-08513 50

**8+1 LED** **280 lm** **3 LIGHTING OPTIONS (OFFICE / WAREHOUSE)**  
**WORK TIME CZAS PRACY 4 h 9 LED** **1.5V 3x AA**  
**HOOK HAK** **MAGNETIC**  
**LED**



GB Workshop LED battery lamp  
 D D kku-hand eueh e  
 PL Diodowa lampa warsztatowa akumulatorowa  
 RUS Аккумуляторный светодиодный светильник для мастерской  
 CZ Ruční svítidla LED  
 H Ledes szerelőlámpa címkéjű cikkek  
 RO Lampa portabila cu acumulator leduri  
 F Lampe baladeuse  
 I Lampada led per autofficina  
 E in erna D recar ab e  
 CN 可充長款釘附

**27 LED**  
**13000 MCD**  
**3.6V 1200mAh Ni-MH**

230V~50Hz BATTERY CHARGER LADOWARKA  
 WATER PROOF ODPORNA NA WODE

CHARGING TIME CZAS LADOWANIA  
**4 h**

HOOK HAK  
 MAGNETIC

**LED**



**YATO**  
 YT-08523 10



GB Workshop LED battery lamp  
 D D kku-hand eueh e  
 PL Diodowa lampa warsztatowa akumulatorowa  
 RUS Аккумуляторный светодиодный светильник для мастерской  
 CZ Ruční svítidla LED  
 H Ledes szerelőlámpa címkéjű cikkek  
 RO Lampa portabila cu acumulator leduri  
 F Lampe baladeuse  
 I Lampada per officina spaccata  
 E in erna D recar ab e  
 CN 可充長款釘附

**30/7 LED**  
**13000 MCD**  
**3.6V 1200mAh Ni-MH**

230V~50Hz BATTERY CHARGER LADOWARKA  
 CHARGING TIME CZAS LADOWANIA  
**4-5 h**

15 h (7 LED)  
 4 h (30 LED)

HOOK HAK  
 MAGNETIC

**LED**



**YATO**  
 YT-08505 10



GB Rechargeable work lamp  
 D Led Werkstattlampe  
 PL Diodowa lampa warsz a owa  
 RUS Светодиодная беспроводная лампа  
 CZ Montážní lampa diodová bezpřívodová  
 H Ledlámpa  
 RO Lampa cu led fara cablu  
 F Lampe baladeuse  
 I Lampada led per autofficina  
 E Lámpara inalámbrica de diodos  
 CN 可充电工作灯

**4 LED**  
**400 lm**  
**IP65**

WIRE PRZEWOŁ 4.9 m  
 HOOK HAK

**LED**



**YATO**  
 YT-08531 10



GB Rechargeable work lamp  
 D Led Werkstattlampe  
 PL Diodowa lampa warsz a owa  
 RUS Светодиодная беспроводная лампа  
 CZ Montážní lampa diodová bezpřívodová  
 H Ledlámpa  
 RO Lampa cu led fara cablu  
 F Lampe baladeuse  
 I Lampada led per autofficina  
 E Lámpara inalámbrica de diodos  
 CN 可充电工作灯

**60+1 LED**  
**13000 MCD**  
**7.2V 800mAh Ni-MH**

230V~50Hz BATTERY CHARGER LADOWARKA  
 WATER PROOF ODPORNA NA WODE

4 h

HOOK HAK  
 MAGNETIC

**LED**



**YATO**  
 YT-0852 5/20



GB Under bonnet work led lamp  
D Led Werkstattlampe  
PL Diodowa lampa warsztatowa do oświetlenia komory silnika  
RUS Светодиодная беспроводная лампа  
CZ Montážní lampa diodová bezpřívodová

H Ledlámpa  
RO Lampa cu led fara cablu  
F Rampe d'éclairage  
I Lampada led trasportabile per illuminazione di vani motore  
E Lámpara inalámbrica de diodos  
CN 引擎盖检修灯

<b>100 LED</b>	<b>600 lm</b>	<b>7.4V</b> 2000mAh Li-ion
<b>230V~50Hz</b> BATTERY CHARGER ŁADOWNIK	<b>CHARGING TIME</b> CZAS ŁADOWANIA <b>3-4 h</b>	<b>WORK TIME</b> CZAS PRACY <b>4 h</b> 100 LED
<b>HOOK</b> HAK	<b>MAGNETIC</b>	<b>LED</b>



GB Under bonnet work led lamp  
D Led Werkstattlampe  
PL Diodowa lampa warsztatowa do oświetlenia komory silnika  
RUS Светодиодная беспроводная лампа  
CZ Montážní lampa diodová bezpřívodová

H Ledlámpa  
RO Lampa cu led fara cablu  
F Rampe d'éclairage  
I Lampada led trasportabile per illuminazione di vani motore  
E Lámpara inalámbrica de diodos  
CN 引擎盖检修灯



<b>120 LED</b>	<b>13000 MCD</b>	<b>60 LED</b>	<b>120 LED</b>
<b>7.2V</b> 1800mAh NI-MH	<b>230V~50Hz</b> BATTERY CHARGER ŁADOWNIK	<b>WORK TIME</b> CZAS PRACY <b>8 h</b> 60 LED	<b>4 h (120 LED)</b>
<b>CHARGING TIME</b> CZAS ŁADOWANIA <b>4-5 h</b>	<b>HOOK</b> HAK	<b>MAGNETIC</b>	<b>LED</b>

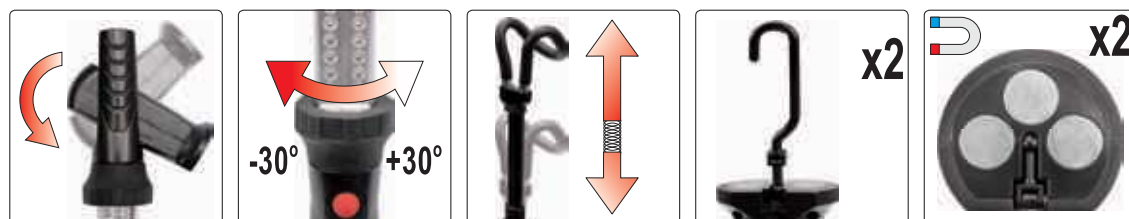

GB Rubber protection extension cord  
 D Gummiisolierte erdverdrahtungsschnur  
 PL Przedłużacz w osłonie gumowej  
 RUS Удлинитель с резиновой изоляцией  
 CZ Prodlužovací kabel s gumovou izolací  
 H Gumi szigetelésű hosszabbító  
 RO Cablu prelungitor cauciuc  
 F Raon e ecri ue  
 I Pro un a in omma  
 E Cab e de e ensión con protección de caucho  
 CN 电缆延长线

**IP44** **16A**

CABLE **H05RR-F** KABEL  
**3G1.5 mm<sup>2</sup>**  
CABLE / KABEL

**E & F** TYPE / TYP **E** TYPE / TYP

**230V~50Hz**



YATO	L (m)	
YT-81021	10	8
YT-81022	20	4
YT-81023	30	4
YT-81024	40	2

GB Rubber protection extension cord  
 D Gummiisolierte erdverdrahtungsschnur  
 PL Przedłużacz w osłonie gumowej  
 RUS Удлинитель с резиновой изоляцией  
 CZ Prodlužovací kabel s gumovou izolací  
 H Gumi szigetelésű hosszabbító  
 RO Cablu prelungitor cauciuc  
 F Raon e ecri ue  
 I Pro un a in omma  
 E Cab e de e ensión con protección de caucho  
 CN 电缆延长线

**IP44** **16A**

CABLE **H05RR-F** KABEL  
**3G2.5 mm<sup>2</sup>**  
CABLE / KABEL

**E & F** TYPE / TYP **E** TYPE / TYP

**230V~50Hz**



YATO	L (m)	
YT-8100	20	4
YT-8101	30	2
YT-8102	40	2

GB Rubber protection extension cord  
 D Gummiisolierte erdverdrahtungsschnur  
 PL Przedłużacz w osłonie gumowej  
 RUS Удлинитель с резиновой изоляцией  
 CZ Prodlužovací kabel s gumovou izolací  
 H Gumi szigetelésű hosszabbító  
 RO Cablu prelungitor cauciuc  
 F Raon e ecri ue  
 I Pro un a in omma  
 E Cab e de e ensión con protección de caucho  
 CN 电缆延长线

**IP44** **16A**

CABLE **H07RN-F** KABEL  
**3G1.5 mm<sup>2</sup>**  
CABLE / KABEL

**E & F** TYPE / TYP **E** TYPE / TYP

**230V~50Hz**



YATO	L (m)	
YT-8110	2	40
YT-8111	5	16
YT-8112	10	8

GB Rubber protection extension cord  
 D Gummiisolierte erdverdrahtungsschnur  
 PL Przedłużacz w osłonie gumowej  
 RUS Удлинитель с резиновой изоляцией  
 CZ Prodlužovací kabel s gumovou izolací  
 H Gumi szigetelésű hosszabbító  
 RO Cablu prelungitor cauciuc  
 F Raon e ecri ue  
 I Pro un a in omma  
 E Cab e de e ensión con protección de caucho  
 CN 电缆延长线

**IP44** **16A**

CABLE **H07RN-F** KABEL  
**3G1.5 mm<sup>2</sup>**  
CABLE / KABEL

**E & F** TYPE / TYP **E** TYPE / TYP

**230V~50Hz**



YATO	L (m)	
YT-8115	2	10
YT-8116	10	4
YT-81162	20	4

GB Cable reel  
D Kabelrolle  
PL Przedłużacz zwijany  
RUS Удлинитель электрический  
CZ Bubnový prodloužovač  
H Kábel dob  
RO Prelungitor pe tambur  
F Raon e cri ue  
sur ambour enrou eur  
I vvo icavo con bobina  
E Cable de prolongación  
de ambor  
CN 电缆延长线



IP44	16A
CABLE H05RR-F KABEL	3G1.5 mm <sup>2</sup> CABLE / KABEL
E & F TYPE / TYP	E TYPE / TYP
230V~ 50Hz	

• P<sub>ma</sub> = 1000 W coiled  
P<sub>ma</sub> = 1000 W zwinięty  
• P<sub>ma</sub> = 3000 W uncoiled  
P<sub>ma</sub> = 3000 W rozwinięty

YATO	L (m)	
YT-81052	20	2
YT-81053	30	2
YT-81054	40	2

GB Cable reel  
D Kabelrolle  
PL Przedłużacz zwijany  
RUS Удлинитель электрический  
CZ Bubnový prodloužovač  
H Kábel dob  
RO Prelungitor pe tambur  
F Raon e cri ue  
sur ambour enrou eur  
I vvo icavo con bobina  
E Cable de prolongación  
de ambor  
CN 电缆延长线



IP44	16A
CABLE H05RR-F KABEL	3G2.5 mm <sup>2</sup> CABLE / KABEL
E & F TYPE / TYP	E TYPE / TYP
PLASTIC REEL BEBEN PLÁSTIKOVÝ	230V~ 50Hz

• P<sub>ma</sub> = 1200 W coiled  
P<sub>ma</sub> = 1200 W zwinięty  
• P<sub>ma</sub> = 3600 W uncoiled  
P<sub>ma</sub> = 3600 W rozwinięty

YATO	L (m)	
YT-8106	30	1
YT-8107	40	1
YT-8108	50	1

GB Drum power extension cord  
D erän erun s romme f r Kraf s rom  
PL Przedłużacz bębnowy silowy  
RUS Силовой удлинитель барабанного типа  
CZ Prodloužovací kabel silový na bubnu  
H Háromfázisú hosszabbító dob  
RO Deru a or cu ambur  
F Raon e cri ue  
sur ambour enrou eur  
I vvo icavo di forza  
E Ci indro de e nsión de fuerza  
CN 电缆延长线



IP44	~400V ~230V
CABLE H07RN-F KABEL	5G2.5 mm <sup>2</sup> CABLE / KABEL
3P+N+E	3P+N+E 2x 2P+E

• V P E  
P<sub>ma</sub> = 1200 W coiled  
P<sub>ma</sub> = 1200 W zwinięty  
P<sub>ma</sub> = 3000 W uncoiled  
P<sub>ma</sub> = 3000 W rozwinięty

• V P N E  
P<sub>ma</sub> = 3000 W coiled  
P<sub>ma</sub> = 3000 W zwinięty  
P<sub>ma</sub> = 9000 W uncoiled  
P<sub>ma</sub> = 9000 W rozwinięty

YATO	L (m)	
YT-8120	25	1

# 23

## Garden tools Narzędzia ogrodnicze





Watering program  
Program wodny

442-452



Trees and bushes care  
Pielęgnacja drzew i krzewów

453-458



Garden hose carts & holders

Wózki i stojaki na wąż ogrodowy..... 442

Spray guns & lances

Pistolety i lance zraszające..... 443

Spray nozzles

Zraszacze..... 447

Garden showers

Prysznice ogrodowe..... 449

Water timers

Sterowniki nawadniania..... 449

Connectors

Złączki..... 450

Couplings

Rozdzielacze..... 451

Sets

Zestawy..... 452

Lawn care

Pielęgnacja trawnika

453



Hand hedge shears

Ręczne nożyce do żywopłotu..... 453

Garden pruners

Sekatory ogrodowe..... 454

Lopping shears

Sekatory do gałęzi..... 456

Saws for tall trees and bushes

Piły do wysokich drzew i krzewów..... 457

Garden hand saws

Piły ogrodowe ręczne..... 458

Axes

Siekiery..... 458

Garden care

Narzędzia do pielęgnacji ogrodu

459-461



Small garden tools

Małe narzędzia ogrodowe..... 459

Garden hand saws

Piły ogrodowe ręczne..... 460

Big garden tools



Duże narzędzia ogrodowe..... 461

Hand grass shears

Ręczne nożyce do trawy..... 453

- GB Hose holder
- D Gar ensch auch rä er
- PL Stojak do węza ogrodowego
- RUS Барабан для намотки поливочного шланга
- CZ Stojan navijecí na zahradní hadici
- H Utartódob locsolótömlöhöz
- RO Suport pt. furtun
- F D vidoir sur roues
- I Carre o avvo i ubo
- E Estante para manguera de jardin
- CN 卷线盘





  $\varnothing$  3/4" (19 mm) **45 m**  
  $\varnothing$  1/2" (12.5 mm) **50 m**

**PP**

COLOR BOX



YATO 	hose size / rozmiar węza (m)	
YT-99850	3/4" (19.0 mm) / 45 m 1/2" (12.5 mm) / 50 m	2

- GB Hose holder
- D Gar ensch auch rä er
- PL Stojak do węza ogrodowego
- RUS Барабан для намотки поливочного шланга
- CZ Stojan navijecí na zahradní hadici
- H Utartódob locsolótömlöhöz
- RO Suport pt. furtun
- F D vidoir sur roues
- I Carre o avvo i ubo
- E Estante para manguera de jardin
- CN 卷线盘





  $\varnothing$  3/4" (19 mm) **45 m**  
  $\varnothing$  1/2" (12.5 mm) **50 m**

**PP**

COLOR BOX



YATO 	hose size / rozmiar węza (m)	
YT-99852	3/4" (19.0 mm) / 45 m 1/2" (12.5 mm) / 50 m	2

- GB Hose holder
- D Gar ensch auch rä er
- PL Stojak do węza ogrodowego
- RUS Барабан для намотки поливочного шланга
- CZ Stojan navijecí na zahradní hadici
- H Utartódob locsolótömlöhöz
- RO Suport pt. furtun
- F D vidoir sur roues
- I Carre o avvo i ubo
- E Estante para manguera de jardin
- CN 卷线盘





  $\varnothing$  3/4" (19 mm) **45 m**  
  $\varnothing$  1/2" (12.5 mm) **50 m**

**PP**

COLOR BOX



YATO 	hose size / rozmiar węza (m)	
YT-99853	3/4" (19.0 mm) / 45 m 1/2" (12.5 mm) / 50 m	2

GB Adjustable spray gun  
D Regelbare Sprühpistole  
PL Pistolet zraszający  
re u owan  
RUS Регулируемый  
оросительный пистолет  
CZ Kropící pistole  
re u ova e nã

H Öntöző pisztoly,  
állítható sugarú  
RO Pistolet de irigare ajustabil  
F Pis o e d arrosa e r  
I Pistola a spruzzo regolabile  
E Pistola rociadora ajustable  
CN 调节式水枪

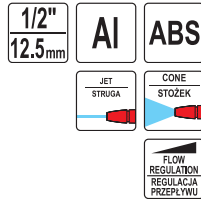

TIED ON CARD



**YATO** size / rozmiar  
YT-99833 1/2" / 12.5 mm 12/48

GB Adjustable spray gun  
D Regelbare Sprühpistole  
PL Pistolet zraszający  
re u owan  
RUS Регулируемый  
оросительный пистолет  
CZ Kropící pistole  
re u ova e nã

H Öntöző pisztoly,  
állítható sugarú  
RO Pistolet de irigare ajustabil  
F Pis o e d arrosa e r  
I Pistola a spruzzo regolabile  
E Pistola rociadora ajustable  
CN 调节式水枪

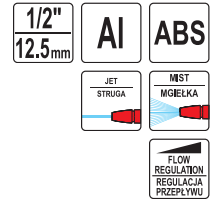

TIED ON CARD



**YATO** size / rozmiar  
YT-8965 1/2" / 12.5 mm 12/48

GB Adjustable spray gun  
D Regelbare Sprühpistole  
PL Pistolet zraszający  
re u owan  
RUS Регулируемый  
оросительный пистолет  
CZ Kropící pistole  
re u ova e nã

H Öntöző pisztoly,  
állítható sugarú  
RO Pistolet de irigare ajustabil  
F Pis o e d arrosa e r  
I Pistola a spruzzo regolabile  
E Pistola rociadora ajustable  
CN 调节式水枪

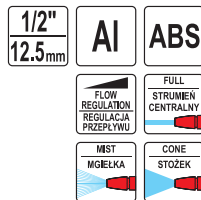

TIED ON CARD



**YATO** size / rozmiar  
YT-8955 1/2" / 12.5 mm 12/48

GB Adjustable spray gun  
D Regelbare Sprühpistole  
PL Pistolet zraszający  
re u owan  
RUS Регулируемый  
оросительный пистолет  
CZ Kropící pistole  
re u ova e nã

H Öntöző pisztoly,  
állítható sugarú  
RO Pistolet de irigare ajustabil  
F Pis o e d arrosa e r  
I Pistola a spruzzo regolabile  
E Pistola rociadora ajustable  
CN 调节式水枪

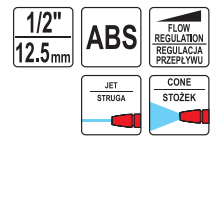

TIED ON CARD



**YATO** size / rozmiar  
YT-99834 1/2" / 12.5 mm 12/48

GB Adjustable spray gun  
D Regelbare Sprühpistole  
PL Pistolet zraszający  
re u owan  
RUS Регулируемый  
оросительный пистолет  
CZ Kropící pistole  
re u ova e nã

H Öntöző pisztoly,  
állítható sugarú  
RO Pistolet de irigare ajustabil  
F Pis o e d arrosa e r  
I Pistola a spruzzo regolabile  
E Pistola rociadora ajustable  
CN 调节式水枪

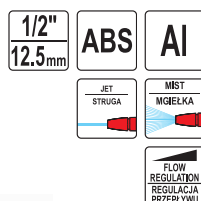

TIED ON CARD



**YATO** size / rozmiar  
YT-8966 1/2" / 12.5 mm 12/48

GB Adjustable spray gun  
D Regelbare Sprühpistole  
PL Pistolet zraszający  
re u owan  
RUS Регулируемый  
оросительный пистолет  
CZ Kropící pistole  
re u ova e nã

H Öntöző pisztoly,  
állítható sugarú  
RO Pistolet de irigare ajustabil  
F Pis o e d arrosa e r  
I Pistola a spruzzo regolabile  
E Pistola rociadora ajustable  
CN 调节式水枪

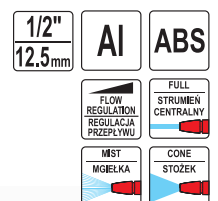

TIED ON CARD



**YATO** size / rozmiar  
YT-8956 1/2" / 12.5 mm 12/48

GB Adjustable spray gun  
D Regelbare Sprühpistole  
PL Pistolet zraszający  
re uowan  
RUS Регулируемый  
оросительный пистолет  
CZ Kropící pistole  
re u ova e ná

H Öntöző pisztoly,  
állítható sugarú  
RO Pistolet de irigare ajustabil  
F Pis o e d arrosa e r  
I Pistola a spruzzo regolabile  
E Pistola rociadora ajustable  
CN 调节式水枪

1/2"  
12.5mm

AI ABS

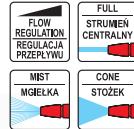

TIED ON CARD

YATO size / rozmiar  
YT-8957 1/2" / 12.5 mm 12/48

GB Adjustable spray gun  
D Regelbare Sprühpistole  
PL Pistolet zraszający  
re uowan  
RUS Регулируемый  
оросительный пистолет  
CZ Kropící pistole  
re u ova e ná  
H Öntöző pisztoly,  
állítható sugarú

RO Pistolet de irigare ajustabil  
F Pis o e d arrosa e r  
I Pistola a spruzzo regolabile  
E Pistola rociadora ajustable  
CN 调节式水枪

1/2"  
12.5mm

BRASS MOSIADZ

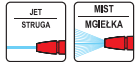

TIED ON CARD

YATO size / rozmiar  
YT-8967 1/2" / 12.5 mm 12

GB Multifunction sprinkling gun  
D Multifunktions-Spritzpistole  
PL Wielofunkcyjny pistolet  
zraszający  
RUS Многофункциональный  
оросительный пистолет  
CZ Multifunkční  
postřikovací  
pistole  
H Többfunkciós  
öntöző  
pisztoly

RO Pistol multifuncțional  
pt. pulverizare  
F Pis o e d arrosa e  
I Multifunzione pistola a spruzzo  
E Pistola para  
re ar mu ifunciona  
CN 六用途调节式水枪

1/2"  
12.5mm

AI

ABS



TIED ON CARD

YATO size / rozmiar  
YT-8958 1/2" / 12.5 mm 12/48

GB Multifunction sprinkling gun  
D Multifunktions-Spritzpistole  
PL Wielofunkcyjny pistolet  
zraszający  
RUS Многофункциональный  
оросительный пистолет  
CZ Multifunkční  
postřikovací  
pistole  
H Többfunkciós  
öntöző  
pisztoly

RO Pistol multifuncțional  
pt. pulverizare  
F Pis o e d arrosa e  
I Multifunzione pistola a spruzzo  
E Pistola para  
re ar mu ifunciona  
CN 六用途调节式水枪

1/2"  
12.5mm

AI

ABS



TIED ON CARD

YATO size / rozmiar  
YT-8964 1/2" / 12.5 mm 12/48

GB Multifunction sprinkling gun  
D Multifunktions-Spritzpistole  
PL Wielofunkcyjny pistolet  
zraszający  
RUS Многофункциональный  
оросительный пистолет  
CZ Multifunkční  
postřikovací  
pistole  
H Többfunkciós  
öntöző  
pisztoly

RO Pistol multifuncțional  
pt. pulverizare  
F Pis o e d arrosa e  
I Multifunzione pistola a spruzzo  
E Pistola para  
re ar mu ifunciona  
CN 六用途调节式水枪

1/2"  
12.5mm

AI

ABS

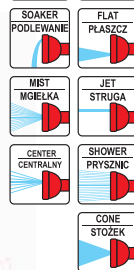

TIED ON CARD

YATO size / rozmiar  
YT-8963 1/2" / 12.5 mm 12/48

GB Multifunction sprinkling gun  
D Multifunktions-Spritzpistole  
PL Wielofunkcyjny pistolet  
zraszający  
RUS Многофункциональный  
оросительный пистолет  
CZ Multifunkční  
postřikovací  
pistole  
H Többfunkciós  
öntöző  
pisztoly

RO Pistol multifuncțional  
pt. pulverizare  
F Pis o e d arrosa e  
I Multifunzione pistola  
a spruzzo  
E Pistola para  
re ar mu ifunciona  
CN 六用途调节式水枪

1/2"  
12.5mm

AI

ABS



TIED ON CARD

YATO size / rozmiar  
YT-8959 1/2" / 12.5 mm 12/48

GB Multifunction sprinkling gun  
D Multifunktions-Spritzpistole  
PL Wielofunkcyjny pistolet zraszający  
RUS Многофункциональный оросительный пистолет  
CZ Multifunkční postřikovací pistole  
H Többfunkciós öntöző pisztoly

RO Pistol multifuncțional pt. pulverizare  
F Pistolet d'arrosage multifonctionnel  
I Multifunzione pistola a spruzzo  
E Pistola para regar multifuncional  
CN 六用途调节式水枪

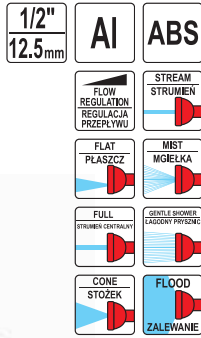

TIED ON CARD

**YATO** size / rozmiar  
YT-8960 1/2" / 12.5 mm 12/48

GB Multifunction sprinkling gun  
D Multifunktions-Spritzpistole  
PL Wielofunkcyjny pistolet zraszający  
RUS Многофункциональный оросительный пистолет  
CZ Multifunkční postřikovací pistole  
H Többfunkciós öntöző pisztoly

RO Pistol multifuncțional pt. pulverizare  
F Pistolet d'arrosage multifonctionnel  
I Multifunzione pistola a spruzzo  
E Pistola para regar multifuncional  
CN 六用途调节式水枪

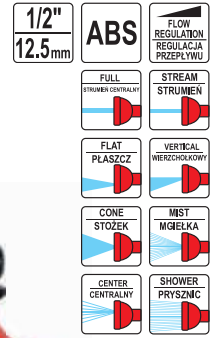

TIED ON CARD

**YATO** size / rozmiar  
YT-99841 1/2" / 12.5 mm 12/48

GB Multifunction sprinkling gun  
D Multifunktions-Spritzpistole  
PL Wielofunkcyjny pistolet zraszający  
RUS Многофункциональный оросительный пистолет  
CZ Multifunkční postřikovací pistole  
H Többfunkciós öntöző pisztoly

RO Pistol multifuncțional pt. pulverizare  
F Pistolet d'arrosage multifonctionnel  
I Multifunzione pistola a spruzzo  
E Pistola para regar multifuncional  
CN 六用途调节式水枪

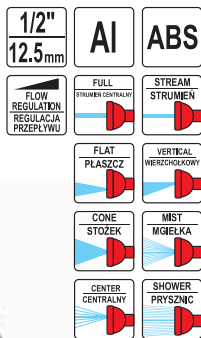

TIED ON CARD

**YATO** size / rozmiar  
YT-99840 1/2" / 12.5 mm 12/48

GB Multifunction sprinkling gun  
D Multifunktions-Spritzpistole  
PL Wielofunkcyjny pistolet zraszający  
RUS Многофункциональный оросительный пистолет  
CZ Multifunkční postřikovací pistole  
H Többfunkciós öntöző pisztoly

RO Pistol multifuncțional pt. pulverizare  
F Pistolet d'arrosage multifonctionnel  
I Multifunzione pistola a spruzzo  
E Pistola para regar multifuncional  
CN 六用途调节式水枪

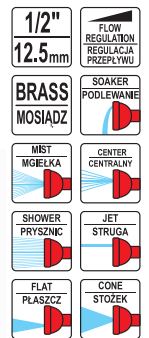

TIED ON CARD

**YATO** size / rozmiar  
YT-8968 1/2" / 12.5 mm 12

GB Sprinkling lance  
D Multifunktions-Spritzstab  
PL Lanza zraszająca wielofunkcyjna  
RUS Пика для распылителя многофункциональная  
CZ Multifunkční postřikovací nadstavec

H Többfunkciós esőztető fej  
RO Tijă pt. irigare  
F Pistolet lance d'arrosage télescopique  
I Spray lancia multifunzionale  
E Lanza para regar multifuncional  
CN 六用途调节式水枪

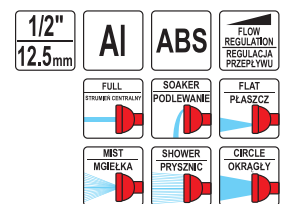

TIED ON CARD

**YATO** size / rozmiar  
YT-8961 1/2" / 12.5 mm 12

GB Garden shower  
 D Gar endusche  
 PL Pr sznic o rodow  
 RUS Распылитель садовый  
 CZ Zahradní sprcha  
 H Ker i zuhan  
 RO Duş pt. grădină  
 F Piseance d'arrosage télescopique  
 I Doccia da giardino  
 E Regadera para jardín  
 CN 调节式水枪

1/2"  
12.5mm

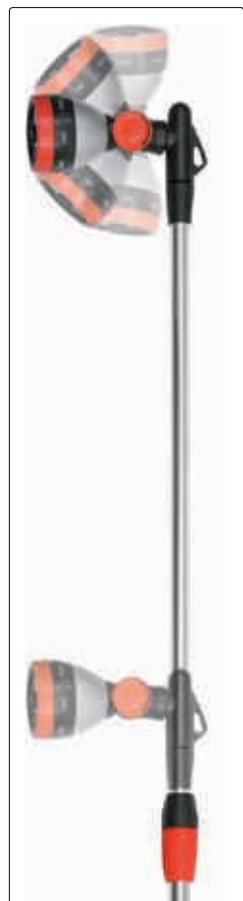

TIED ON CARD

<b>YATO</b> 	size / rozmiar	L (cm)	
YT-8962	1/2" / 12.5 mm	90-135	12

GB Garden shower  
 D Gar endusche  
 PL Pr sznic o rodow  
 RUS Распылитель садовый  
 CZ Zahradní sprcha  
 H Ker i zuhan  
 RO Duş pt. grădină  
 F Piseance d'arrosage télescopique  
 I Doccia da giardino  
 E Regadera para jardín  
 CN 调节式水枪

1/2"  
12.5mm

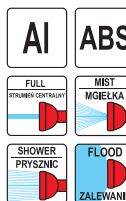

TIED ON CARD

<b>YATO</b> 	size / rozmiar	L (cm)	
YT-99843	1/2" / 12.5 mm	100-145	12

GB Adjustable spray nozzle  
D Spritze  
PL Zraszacz prosty regulowany  
RUS Распылитель поливочный  
CZ Postřikovač  
H Szórófej  
RO Stropitor apă

F Pistolet d'arrosage  
I Semplice sprinkler  
E Rociador  
CN 铝合金调节式水枪

1/2"  
12.5mm

Zn

ABS



TIED ON CARD

<b>YATO</b>	size / rozmiar	
YT-8950	1/2" / 12.5 mm	12/48

GB Adjustable spray nozzle  
D Spritze  
PL Zraszacz prosty regulowany  
RUS Распылитель поливочный  
CZ Postřikovač  
H Szórófej  
RO Stropitor apă

F Pistolet d'arrosage  
I Semplice sprinkler  
E Rociador  
CN 铝合金调节式水枪

1/2"  
12.5mm

ABS

FLOW  
REGULATION  
PRZEPIĘTYW



TIED ON CARD

<b>YATO</b>	size / rozmiar	
YT-99830	1/2" / 12.5 mm	12/48

GB Impulse sprinkler  
D Impulssprenger  
PL Zraszacz impulsowy  
RUS Распылитель импульсный на пике  
CZ Postřikovač  
H Impulzus szórófej  
RO Stropitor apă  
F Arroseur impulsion sur piquet  
I Sprinkler impulso  
E Rociador  
CN 脉冲洒水器

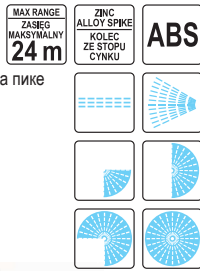

TIED ON CARD

<b>YATO</b>	
YT-8985	48

GB Impulse sprinkler  
D Impulssprenger  
PL Zraszacz impulsowy  
RUS Распылитель импульсный на пике  
CZ Postřikovač  
H Impulzus szórófej  
RO Stropitor apă  
F Arroseur impulsion sur piquet  
I Sprinkler impulso  
E Rociador  
CN 脉冲洒水器

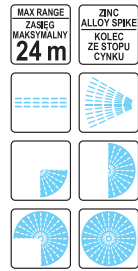

TIED ON CARD

<b>YATO</b>	
YT-8986	48

GB 3-arms revolving sprinkler  
D 3- rm Kreis-Re ner  
PL Zraszacz 3-ramienn  
RUS Трёхсторонний вращающийся  
распылитель на пике  
CZ Rozprašovac třiramenný  
H osco ó eszúrha ó for ó  
RO Aspersol cu 3 brate  
F Arroseur sur piquet 3 branches  
I Tre braccio sprinkler  
E Rociador 3-brazos  
CN 三叉插针洒水器



TIED ON CARD

<b>YATO</b>	
YT-8987	48

GB Tripod impulse sprinkler  
D Impulssprenger  
PL Zraszacz impulsowy na statywie  
RUS Распылитель импульсный  
CZ Postřikovač  
H Impulzus szórófej  
RO Stropitor apă  
F Arroseur impulsion lance  
I Sprinkler impulso su un treppiede  
E Rociador  
CN 洒水器

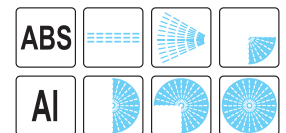

COLOR BOX



<b>YATO</b>	
YT-8984	12

- GB Impulse sprinkler with base
- D Impulssprenger
- PL Zraszacz impulsowy naziemny
- RUS Распылитель импульсный
- CZ Postřikovač
- H Impulzus szórófej
- RO Stropitor apă
- F Turbine d'arrosage
- I Sprinkler impulso a terra
- E Rociador
- CN 脉冲洒水器



MAX RANGE  
ZASIEG  
MAKSYMALNY  
**24 m**

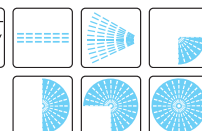

COLOR BOX

<b>YATO</b>	
YT-8988	24

- GB 8 pattern sprinkler
- D 8-Flächenregner
- PL Zraszacz 8-funkcyjny
- RUS Распылитель 8-позиционный на подставке
- CZ Postríkovač
- H 8 funkciós szórófej
- RO Stropitor apă cu 8 duze
- F Turbine d'arrosage 8 fonc ionnes
- I Sprinkler 8-funzioni
- E Rociador 8-funciones de tierra
- CN 洒水器



FLOW  
REGULATION  
REGULACIJA  
PRZEPŁYWU

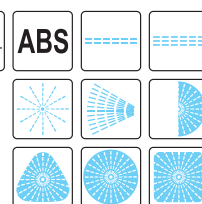

TIED ON CARD

<b>YATO</b>	
YT-8991	48

- GB Aluminium tube oscillating sprinkler
- D iereckre ner
- PL Zraszacz oscylacyjny z rurką aluminiową
- RUS Распылитель осциллирующий
- CZ Postríkovač
- H Oszillációs szórófej
- RO Stropitor apă
- F rroseur osci an auminium
- I Oscillante sprinkler con tubo di alluminio
- E Rociador ira orio con tubo de aluminio
- CN 摇摆洒水器

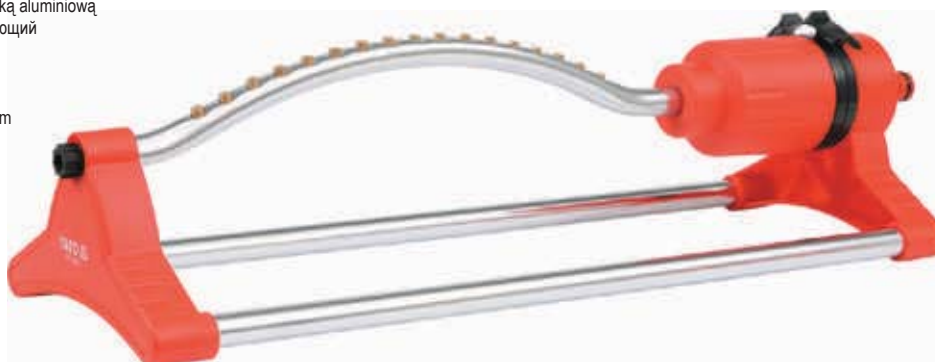

**17**  
HOLES  
OTWORÓW

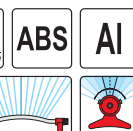

COLOR BOX



<b>YATO</b>	
YT-8993	6

- GB Tube oscillating sprinkler
- D iereckre ner
- PL Zraszacz oscylacyjny
- RUS Распылитель осциллирующий
- CZ Postríkovač
- H Oszillációs szórófej
- RO Stropitor apă
- F rroseur osci an
- I Oscillante sprinkler
- E Rociador ira orio
- CN 摇摆洒水器



**17**  
HOLES  
OTWORÓW

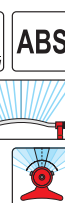

COLOR BOX



<b>YATO</b>	
YT-99845	6



GB Sprinkling lance  
D Multifunktions-Spritzstab  
PL Lanza zraszająca wielofunkcyjna  
RUS Пика для распылителя  
многофункциональная

CZ Multifunkční postřikovací nadstavec  
H Többfunkciós esőztető fej  
RO Tija pt. irigare  
F Pistoie lance d'arrosage télescopique

I Spray lancia multifunzionale  
E Lanza para regar multifuncional  
CN 六用途调节式水枪

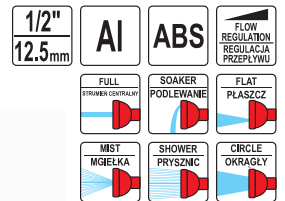

TIED ON CARD

YATO	size / rozmiar	
YT-8961	1/2" / 12.5 mm	12

GB Garden shower  
D Gardendusche  
PL Prysznic ogrodowy  
RUS Распылитель садовый  
CZ Zahradní sprcha  
H Kerizuhan  
RO Duș pt. grădină  
F Pistoie lance d'arrosage télescopique  
I Doccia da giardino  
E Regadera para jardín  
CN 调节式水枪

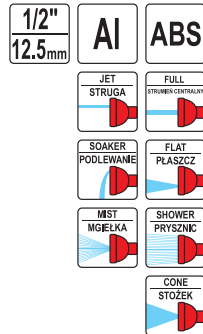

TIED ON CARD

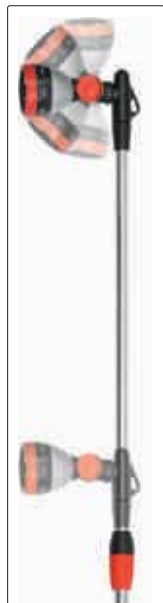

YATO	size / rozmiar	L (cm)	
YT-8962	1/2" / 12.5 mm	90-135	12

GB Garden shower  
D Gardendusche  
PL Prysznic ogrodowy  
RUS Распылитель садовый  
CZ Zahradní sprcha  
H Kerizuhan  
RO Duș pt. grădină  
F Pistoie lance d'arrosage télescopique  
I Doccia da giardino  
E Regadera para jardín  
CN 调节式水枪

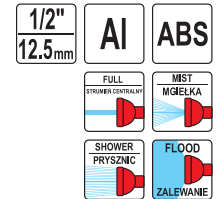

TIED ON CARD

YATO	size / rozmiar	L (cm)	
YT-99843	1/2" / 12.5 mm	100-145	12

GB Multifunction preset water timer  
D Bewässerungsuhr  
PL Sterownik nawadniania  
RUS Таймер для управления подачей воды  
CZ Zavlažovací hodiny  
H Vizprogramozó óra  
RO Programator manual  
F Conducteur d'arrosage manuel  
I Conroloir irriazione manuale  
E Programador manual para tubos de agua  
CN 多功能洒水定时器

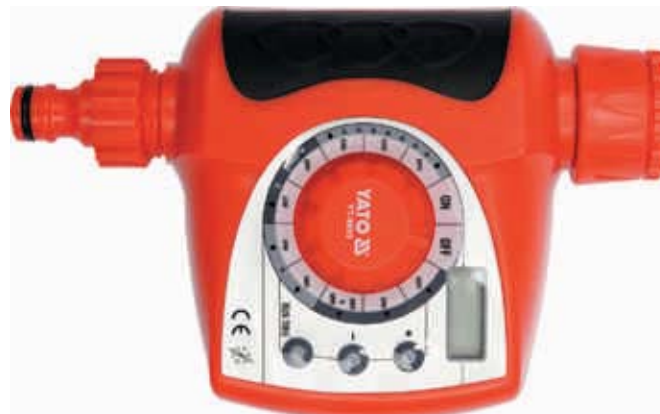

DOUBLE BLISTER



YATO		
YT-9955		12

GB Hose connec or  
D Universa  
Schnellschlauchkupplung  
PL Złącze standard  
RUS Соединитель  
CZ Rychlospojka  
H Fitting  
RO Mufă pt. pistol  
F Raccord s andard  
I Conne ore s andard  
E Jun a es andar  
CN 通水接头

1/2"  
12.5mm

ABS



TIED ON CARD

YATO	size / rozmiar	
YT-99801	1/2" 12.5 mm	12/48

GB Waterstop hose connector  
D Universa  
Schnellschlauchkupplung  
mit Wasserstop  
PL Złącze stop  
RUS Соединитель с автостопом  
CZ Rychlospojka  
H Fitting  
RO Mufă pt. pistol  
F Raccord stop  
I Connettores stop  
E Jun a es andar  
CN 止水接头

1/2"  
12.5mm

ABS

STOP



TIED ON CARD

YATO	size / rozmiar	
YT-99803	1/2" 12.5 mm	12/48

GB Hose mender  
D Schlauchreparator,  
Schlauchverbinder  
PL Reparatör do węzła  
RUS Соединитель шлангов  
CZ Opravka  
H G ors o dó  
RO Mufă inădire  
F Réparateur de tuyau  
I Tubo reparatore  
E Reparatör para manguera  
CN 修补接头

1/2"  
12.5mm

ABS



TIED ON CARD

YATO	size / rozmiar	
YT-99810	1/2" 12.5 mm	12/48

GB Hose connec or  
D Universa  
Schnellschlauchkupplung  
PL Złącze standard  
RUS Соединитель  
CZ Rychlospojka  
H Fitting  
RO Mufă pt. pistol  
F Raccord s andard  
I Conne ore s andard  
E Jun a es andar  
CN 通水接头

3/4"  
19mm

ABS



TIED ON CARD

YATO	size / rozmiar	
YT-99802	3/4" 19.0 mm	12/48

GB Waterstop hose connector  
D Universa  
Schnellschlauchkupplung  
mit Wasserstop  
PL Złącze stop  
RUS Соединитель с автостопом  
CZ Rychlospojka  
H Fitting  
RO Mufă pt. pistol  
F Raccord stop  
I Connettores stop  
E Jun a es andar  
CN 止水接头

3/4"  
19mm

ABS

STOP



TIED ON CARD

YATO	size / rozmiar	
YT-99804	3/4" 19.0 mm	12/48

GB Hose mender  
D Schlauchreparator,  
Schlauchverbinder  
PL Reparatör do węzła  
RUS Соединитель шлангов  
CZ Opravka  
H G ors o dó  
RO Mufă inădire  
F Réparateur de tuyau  
I Tubo reparatore  
E Reparatör para manguera  
CN 修补接头

3/4"  
19mm

ABS



TIED ON CARD

YATO	size / rozmiar	
YT-99811	3/4" 19.0 mm	12/48

GB Hose mender  
D Schlauchreparator,  
Schlauchverbinder  
PL Reparatör do węzła  
RUS Соединитель шлангов  
CZ Opravka  
H G ors o dó  
RO Mufă inădire  
F Réparateur de tuyau  
I Tubo reparatore  
E Reparatör para manguera  
CN 修补接头

1/2"  
3/4"

12.5mm  
19mm

ABS



TIED ON CARD

YATO	size / rozmiar	
YT-8979	1/2"; 3/4" 12.5; 19.0 mm	24/240

GB Hose connec or  
D Universa  
Schnellschlauchkupplung  
PL Złącze standard  
RUS Соединитель  
CZ Rychlospojka  
H Fitting  
RO Mufă pt. pistol  
F Raccord s andard  
I Conne ore s andard  
E Jun a es andar  
CN 通水接头

1/2"  
12.5mm

Zn



TIED ON CARD

YATO	size / rozmiar	
YT-99825	1/2" 12.5 mm	12/48

GB Waterstop hose connector  
D Universa  
Schnellschlauchkupplung  
mit Wasserstop  
PL Złącze stop  
RUS Соединитель с автостопом  
CZ Rychlospojka  
H Fitting  
RO Mufă pt. pistol  
F Raccord stop  
I Connettores stop  
E Jun a es andar  
CN 止水接头

1/2"  
12.5mm

Zn

STOP



TIED ON CARD

YATO	size / rozmiar	
YT-99827	1/2" 12.5 mm	12/48

GB Hose connec or  
D Universa  
Schnellschlauchkupplung  
PL Złącze standard  
RUS Соединитель  
CZ Rychlospojka  
H Fitting  
RO Mufă pt. pistol  
F Raccord s andard  
I Conne ore s andard  
E Jun a es andar  
CN 通水接头

3/4"  
19mm

Zn



TIED ON CARD

YATO	size / rozmiar	
YT-99826	3/4" 19.0 mm	12/48

GB Waterstop hose connector  
D Universa  
Schnellschlauchkupplung  
mit Wasserstop  
PL Złącze stop  
RUS Соединитель с автостопом  
CZ Rychlospojka  
H Fitting  
RO Mufă pt. pistol  
F Raccord stop  
I Connettores stop  
E Jun a es andar  
CN 止水接头

3/4"  
19mm

Zn

STOP



TIED ON CARD

YATO	size / rozmiar	
YT-99828	3/4" 19.0 mm	12/48

GB Snap-in tap adaptor  
D Wasserhahnschuss  
für Gar ensch auch  
PL Przyłącze do kranu  
RUS Адаптер внутренний  
CZ Šroubení  
H Tömlovég csaphoz  
RO Mufă pt. robinet  
cu filet interior  
F Raccord  
I Co e amen o a rubine o  
E Tubu adura de rifo  
CN 铁箍接头

1/2"  
12.5mm

ABS



TIED ON CARD

YATO	size / rozmiar	
YT-8970	1/2" 12.5 mm	24/240

GB Snap-in tap adaptor  
D asserhahnanschuss  
f r Gar ensch auch  
PL Przyłącze do kranu  
RUS Адаптер внутренний  
CZ Šroubení  
H Tömlovég csaphoz  
RO Mufă pt. robinet  
cu file interior  
F Raccord  
I Co e ameno a rubine o  
E Tubu adura de rifo  
CN 铁箍接头

3/4"  
19mm

ABS



TIED ON CARD

YATO	size / rozmiar	
YT-8971	3/4" 19.0 mm	12/120

GB Snap-in tap adaptor  
D asserhahnanschuss  
f r Gar ensch auch  
PL Przyłącze do kranu  
RUS Адаптер внутренний  
CZ Šroubení  
H Tömlovég csaphoz  
RO Mufă pt. robinet  
cu file interior  
F Raccord  
I Co e ameno a rubine o  
E Tubu adura de rifo  
CN 铁箍接头

3/4"  
19mm

ABS



TIED ON CARD

YATO	size / rozmiar	
YT-99812	3/4" 19.0 mm	12/120

GB Snap-in tap adaptor  
D asserhahnanschuss  
f r Gar ensch auch  
PL Przyłącze do kranu  
RUS Адаптер внутренний  
CZ Šroubení  
H Tömlovég csaphoz  
RO Mufă pt. robinet  
cu file interior  
F Raccord  
I Co e ameno a rubine o  
E Tubu adura de rifo  
CN 铁箍接头

1"  
25mm

ABS



TIED ON CARD

YATO	size / rozmiar	
YT-8972	1" 25.0 mm	12/120

GB Snap-in tap adaptor  
D asserhahnanschuss  
f r Gar ensch auch  
PL Przyłącze do kranu  
RUS Адаптер внутренний  
CZ Šroubení  
H Tömlovég csaphoz  
RO Mufă pt. robinet  
cu file interior  
F Raccord  
I Co e ameno a rubine o  
E Tubu adura de rifo  
CN 铁箍接头

1"  
25mm

ABS



TIED ON CARD

YATO	size / rozmiar	
YT-99813	1" 25.0 mm	12/120

GB Snap-in tap adaptor  
D asserhahnanschuss  
f r Gar ensch auch  
PL Przyłącze do kranu  
RUS Адаптер внутренний  
CZ Šroubení  
H Tömlovég csaphoz  
RO Mufă pt. robinet  
cu file interior  
F Raccord  
I Co e ameno a rubine o  
E Tubu adura de rifo  
CN 铁箍接头

1/2"  
3/4"

12.5 mm  
19 mm

ABS



TIED ON CARD

YATO	size / rozmiar	
YT-8973	1/2"; 3/4" 12.5; 19.0 mm	12/120

GB Snap-in tap adaptor  
D asserhahnanschuss  
f r Gar ensch auch  
PL Przyłącze do kranu  
RUS Адаптер внутренний  
CZ Šroubení  
H Tömlovég csaphoz  
RO Mufă pt. robinet  
cu file interior  
F Raccord  
I Co e ameno a rubine o  
E Tubu adura de rifo  
CN 铁箍接头

1/2"  
3/4"

12.5 mm  
19 mm

ABS



TIED ON CARD

YATO	size / rozmiar	
YT-99814	1/2"; 3/4" 12.5; 19.0 mm	12/120

GB Snap-in tap adaptor  
D asserhahnanschuss  
f r Gar ensch auch  
PL Przyłącze do kranu  
RUS Адаптер внутренний  
CZ Šroubení  
H Tömlovég csaphoz  
RO Mufă pt. robinet  
cu file interior  
F Raccord  
I Co e ameno a rubine o  
E Tubu adura de rifo  
CN 铁箍接头

3/4"  
1"

19 mm  
25 mm

ABS



TIED ON CARD

YATO	size / rozmiar	
YT-8974	3/4"; 1" 19.0; 25.0 mm	12/120

GB Snap-in tap adaptor  
D asserhahnanschuss  
f r Gar ensch auch  
PL Przyłącze do kranu  
RUS Адаптер внутренний  
CZ Šroubení  
H Tömlovég csaphoz  
RO Mufă pt. robinet  
cu file interior  
F Raccord  
I Co e ameno a rubine o  
E Tubu adura de rifo  
CN 铁箍接头

3/4"  
1"

19 mm  
25 mm

ABS



TIED ON CARD

YATO	size / rozmiar	
YT-99815	3/4"; 1" 19.0; 25.0 mm	12/120

GB Snap-in tap adaptor  
D asserhahnanschuss  
f r Gar ensch auch  
PL Przyłącze do kranu  
RUS Адаптер внутренний  
CZ Šroubení  
H Tömlovég csaphoz  
RO Mufă pt. robinet  
cu file interior  
F Raccord  
I Co e ameno a rubine o  
E Tubu adura de rifo  
CN 铁箍接头

3/4"  
19mm

ABS



TIED ON CARD

YATO	size / rozmiar	
YT-8975	3/4" 19.0 mm	24/240

GB 2 way coupling  
D Schlauchkupplung  
PL Złącze typu „I”  
RUS Соединитель шлангов  
CZ Spojka  
H „I” típusú csötöldó idom  
RO Prelungitor furtun apă  
F Connecteur type „I”  
I Connettore tipo „I”  
E Junta tipo „I”  
CN 双向水管接头

1/2"  
12.5mm

ABS



TIED ON CARD

YATO	size / rozmiar	
YT-8976	1/2" 12.5 mm	24/240

GB 3 way coupling  
D Drei wege kupplung  
PL Rozdzielacz typu „Y”  
RUS Тройник для шлангов  
CZ Y-kus  
H „Y” típusú elágazás  
RO Distributor 3 cai  
F Dérivation type „Y”  
I Connettore tipo „Y”  
E Distribuidor tipo „Y”  
CN 三向水管接头

1/2"  
12.5mm

ABS



TIED ON CARD

YATO	size / rozmiar	
YT-8977	1/2" 12.5 mm	24/240

GB Y-switch coupling with swivel  
D 2- e e en i  
PL Rozdzie acz z zaworami  
RUS Распределитель внешний  
CZ Rozbočovač s uzavíracími ventily  
H Y-elágazó, 2 db külső menes e e záróva  
RO Racord in cu robinie  
F Dérivation type „Y”  
I Dis ribu ore con va vo e  
E Distribuidor tipo „Y”  
CN 双通水管转换接头

1/2"  
12.5mm

ABS



TIED ON CARD

YATO	size / rozmiar	
YT-8978	1/2" 12.5 mm	24/240

GB One wa tap adaptor  
D Gar en- en i  
PL Zawór o rodow  
RUS Вентиль  
CZ en i

H Szelep  
RO Robine  
F Raccord r u a eur  
I a vo a iardino  
E á vu a  
CN 接头

1/2"  
12.5mm

BRASS  
MOSIADZ

AI

ABS



TIED ON CARD

YATO	size / rozmiar	
YT-9940	1/2" 12.5 mm	12/48

GB Y-switch coupling with swivel  
D 2- e e en i  
PL Rozdzie acz z zaworami  
RUS Распределитель внешний  
CZ Rozbočovač s uzavíracími ventily  
H Y-elágazó, 2 db külső menes elzáróval  
RO Racord in cu robinie  
F Soupape double  
I Dis ribu ore con va vo e  
E Distribuidor tipo „Y”  
CN 两用转换接头

1/2"  
12.5mm

3/4"  
19mm

1"  
25mm

ABS



TIED ON CARD

YATO	size / rozmiar	
YT-99848	1/2" 12.5 mm	12/48

GB Y-switch coupling with swivel  
D 2- e e en i  
PL Rozdzie acz z zaworami  
RUS Распределитель внешний  
CZ Rozbočovač s uzavíracími ventily  
H Y-elágazó, 2 db külső menes e e záróva  
RO Racord in cu robinie  
F Raccord r u a eur doub e  
I Dis ribu ore con va vo e  
E Distribuidor tipo „Y”  
CN 两用转换接头

1/2"  
12.5mm

1"  
25mm

AI

3/4"  
19mm

BRASS  
MOSIADZ

ABS



TIED ON CARD

YATO	size / rozmiar	
YT-9941	1/2" 12.5 mm	12/48

GB Basic hose se wi s rai h nozz e  
D Bewässerungs Spritz und Anschlusset  
PL Zestaw złączek ze zraszaczem prostym  
RUS Набор поливочный  
CZ Postřikovač + spojky  
H Készlet gyorskapocsos csaphoz  
RO Ștut furtun apă cu accesorii pt. robinet  
F Se d'arrosage raccord  
I Set raccordi con sprinkler semplice  
E Jue o de rociar ubu adura de rifo  
CN 水枪组套

1/2"  
3/4"

12.5 mm  
19 mm

ABS

1/2"  
3/4"

12.5 mm  
19 mm

STOP



TIED ON CARD

YATO	size / rozmiar	
YT-8940	1/2"; 3/4" 12.5; 19.0 mm	12/48

GB Basic hose se wi s rai h nozz e  
D Bewässerungs Spritz und Anschlusset  
PL Zestaw złączek ze zraszaczem prostym  
RUS Набор поливочный  
CZ Postřikovač + spojky  
H Készlet gyorskapocsos csaphoz  
RO Ștut furtun apă cu accesorii pt. robinet  
F Se d'arrosage raccord  
I Set raccordi con sprinkler semplice  
E Jue o de rociar ubu adura de rifo  
CN 水枪组套

1/2"  
3/4"

12.5; 19; 25 mm

ABS

1/2"  
3/4"

12.5; 19; 25 mm

STOP



TIED ON CARD

YATO	size / rozmiar	
YT-8941	1/2"; 3/4"; 1" 12.5 mm; 19.0 mm; 25.0 mm	12/48

GB Basic hose se wi s rai h nozz e  
D Bewässerungs Spritz und Anschlusset  
PL Zestaw złączek ze zraszaczem prostym  
RUS Набор поливочный  
CZ Postřikovač + spojky  
H Készlet gyorskapocsos csaphoz  
RO Ștut furtun apă cu accesorii pt. robinet  
F Se d'arrosage raccord  
I Set raccordi con sprinkler semplice  
E Jue o de rociar ubu adura de rifo  
CN 水枪组套

1/2"  
3/4"

12.5; 19; 25 mm

STOP

1"  
25mm

ABS

STOP



TIED ON CARD

YATO	size / rozmiar	
YT-99821	1/2"; 3/4"; 1" 12.5 mm; 19.0 mm; 25.0 mm	12/48

GB Basic hose se wi s rai h nozz e  
D Bewässerungs Spritz und Anschlusset  
PL Zestaw złączek ze zraszaczem prostym  
RUS Набор поливочный  
CZ Postřikovač + spojky  
H Készlet gyorskapocsos csaphoz  
RO Ștut furtun apă cu accesorii pt. robinet  
F Se d'arrosage raccord  
I Set raccordi con sprinkler semplice  
E Jue o de rociar ubu adura de rifo  
CN 水枪组套

1/2"  
3/4"

12.5; 19; 25 mm

Zn

1/2"  
3/4"

12.5; 19; 25 mm

STOP



TIED ON CARD

YATO	size / rozmiar	
YT-8943	1/2"; 3/4"; 1" 12.5 mm; 19.0 mm; 25.0 mm	12/48

GB Se of aske s  
D Dich un ssa z  
PL Zes aw uszce ek do programu wodnego  
RUS Набор прокладок  
CZ Sada těsnění  
H Tömítéskészlet  
RO Se de amiri

F Kit de joints  
I Se di uarnizioni per programma de ac ua  
E Juego de juntas  
CN 墊圈组套

14  
PCS



- 2 x Ø16 x Ø11.0 x 2.5
- 2 x Ø18.5 x Ø11.0 x 3.0
- 2 x Ø30.0 x Ø20.0 x 3.0
- 2 x Ø10.0 x Ø6.0 x 2.0
- 2 x Ø24.0 x Ø15.0 x 3.0
- 2 x Ø12.0 x Ø8.0 x 2.0
- 2 baste



POLYBAG WITH HEADER

YATO	or / a	
YT-9920	YT-8900-YT-8994	20/80

GB Grass shears  
D Hand rasschere  
PL Nożyce do trawy wielopozycyjne  
RUS Ножницы для стрижки травы  
CZ Nožnice na trávu  
H Forgatható fűviró olló

RO Foarfeca pt. gazon  
F Cisai e à azon  
I Cesioie per erba mu ifunzione  
E Tijeras de cesped  
CN 草剪

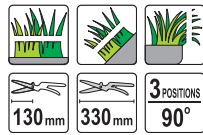

130mm 330mm 3 POSITIONS 90°

PTFE COATED



TRY ME  
HALF BLISTER  
CARD

YATO	L (mm)	
YT-8851	330	12/60

# 1050 mid carbon steel blades

GB Grass shears  
D Hand rasschere  
PL Nożyce do trawy wielopozycyjne  
RUS Ножницы для стрижки травы  
CZ Nožnice na trávu  
H Forgatható fűviró olló

RO Foarfeca pt. gazon  
F Cisai e à azon  
I Cesioie per erba mu ifunzione  
E Tijeras de cesped  
CN 草剪

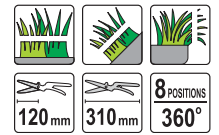

120mm 310mm 8 POSITIONS 360°

PTFE COATED



TRY ME  
HALF BLISTER  
CARD

YATO	L (mm)	
YT-8852	310	6/24

# 1050 mid carbon steel blades

GB Grass shears  
D Hand rasschere  
PL Nożyce do trawy wielopozycyjne  
RUS Ножницы для стрижки травы  
CZ Nožnice na trávu  
H Forgatható fűviró olló

RO Foarfeca pt. gazon  
F Cisai e à azon  
I Cesioie per erba mu ifunzione  
E Tijeras de cesped  
CN 草剪

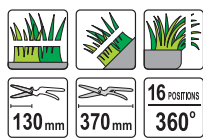

130mm 370mm 16 POSITIONS 360°

S50C PTFE COATED



TRY ME  
HALF BLISTER  
CARD

YATO	L (mm)	
YT-8853	370	6/72

GB Grass shears  
D Hand rasschere  
PL Nożyce do trawy wielopozycyjne  
RUS Ножницы для стрижки травы  
CZ Nožnice na trávu  
H Forgatható fűviró olló

RO Foarfeca pt. gazon  
F Cisai e à azon  
I Cesioie per erba mu ifunzione  
E Tijeras de cesped  
CN 草剪

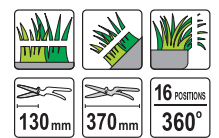

130mm 370mm 16 POSITIONS 360°

S50C PTFE COATED



TRY ME  
HALF BLISTER  
CARD

YATO	L (mm)	
YT-8854	370	6/72

# 1050 mid carbon steel blades

GB Hedge shears  
D Heckenschere  
PL Nożyce do żywoplotu  
RUS Кусторезы  
CZ Nožnice na živý plot  
H Són n vá ó ó ó

RO Foarfeca pt. gard viu  
F Cisai e à haie  
I Cesioie per le siepe  
E Tijeras para seto vivo  
CN 整篱剪

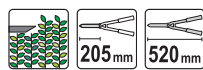

205mm 520mm



HANGING CARD & POUCH ON BLADE

YATO	L (mm)	
YT-8821	520	24

# 1050 mid carbon steel blades

GB Hedge shears  
D Heckenschere  
PL Nożyce do żywoplotu  
RUS Кусторезы  
CZ Nožnice na živý plot  
H Són n vá ó ó ó  
RO Foarfeca pt. gard viu

F Cisai e à haie  
I Cesioie per le siepe  
E Tijeras para seto vivo  
CN 整篱剪



205mm 550mm



HANGING CARD & POUCH ON BLADE

YATO	L (mm)	
YT-8822	550	12

# 1050 mid carbon steel blades

GB Hedge shears  
D Heckenschere  
PL Nożyce do żywoplotu  
RUS Кусторезы  
CZ Nožnice na živý plot  
H Són n vá ó ó ó

RO Foarfeca pt. gard viu  
F Cisai e à haie  
I Cesioie per le siepe  
E Tijeras para seto vivo  
CN 整篱剪

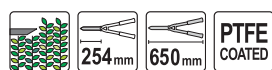

254mm 650mm PTFE COATED



HANGING CARD & POUCH ON BLADE

YATO	L (mm)	
YT-8823	650	12

# 1050 mid carbon steel blades

GB Telescopic hedge shears  
D Heckenschere  
PL Teleskopowe nożyce do żywoplotu  
RUS Кусторезы с телескопическими ручками  
CZ Nožnice na živý plot  
H Són n vá ó ó ó

RO Foarfeca pt. gard viu  
F Cisaille telescopique à haie  
I Cesioie telescopiche per siepe  
E Tijeras para seto vivo  
CN 可伸缩整篱剪

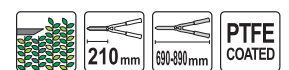

210mm 690-890mm PTFE COATED



HANGING CARD & POUCH ON BLADE

YATO	L (mm)	
YT-8824	690-890	6

# 50 mid carbon steel blades

GB By-pass pruner  
D Rebenschere  
PL Seka or uniwersa n  
RUS Секатор  
CZ Nožnice zahradnicke  
H Me szoo ó

RO Foarfece pt. pomi  
F S ca eur radi ionne  
I Cesoi e universa e  
E Podadera universa  
CN 剪枝剪

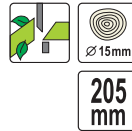

TRY ME  
HALF BLISTER  
CARD

<b>YATO</b>	L (mm)	
YT-8800	205	12/72

mid carbon s ee b ades

GB By-pass pruner  
D Rebenschere  
PL Seka or uniwersa n  
RUS Секатор  
CZ Nožnice zahradnicke  
H Me szoo ó

RO Foarfece pt. pomi  
F S ca eur radi ionne  
I Cesoi e universa e  
E Podadera universa  
CN 剪枝剪



TRY ME  
HALF BLISTER  
CARD

<b>YATO</b>	L (mm)	
YT-8801	220	12/72

hi h carbon s ee b ades

GB By-pass pruner  
D Rebenschere  
PL Seka or uniwersa n  
RUS Секатор  
CZ Nožnice zahradnicke  
H Me szoo ó

RO Foarfece pt. pomi  
F S ca eur radi ionne  
I Cesoi e universa e  
E Podadera universa  
CN 剪枝剪



TRY ME  
HALF BLISTER  
CARD

<b>YATO</b>	L (mm)	
YT-8805	180	12/72

hi h carbon s ee b ades

GB By-pass pruner  
D Rebenschere  
PL Seka or uniwersa n  
RUS Секатор  
CZ Nožnice zahradnicke  
H Me szoo ó

RO Foarfece pt. pomi  
F S ca eur radi ionne  
I Cesoi e universa e  
E Podadera universa  
CN 剪枝剪

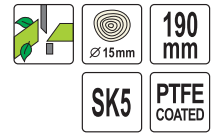

TRY ME  
HALF BLISTER  
CARD

<b>YATO</b>	L (mm)	
YT-8811	190	12/72

GB By-pass pruner  
D Rebenschere  
PL Seka or uniwersa n  
RUS Секатор  
CZ Nožnice zahradnicke  
H Me szoo ó

RO Foarfece pt. pomi  
F S ca eur radi ionne  
I Cesoi e universa e  
E Podadera universa  
CN 剪枝剪

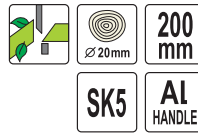

TRY ME  
HALF BLISTER  
CARD

<b>YATO</b>	L (mm)	
YT-8845	200	12/72

GB By-pass pruner  
D Rebenschere  
PL Seka or uniwersa n  
RUS Секатор  
CZ Nožnice zahradnicke  
H Me szoo ó

RO Foarfece pt. pomi  
F S ca eur radi ionne  
I Cesoi e universa e  
E Podadera universa  
CN 剪枝剪

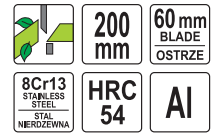

SLIDING  
CARD

<b>YATO</b>	L (mm)	
YT-8790	200	12/60

GB By-pass pruner  
D Rebenschere  
PL Seka or uniwersa n  
RUS Секатор  
CZ Nožnice zahradnicke  
H Me szoo ó

RO Foarfece pt. pomi  
F S ca eur radi ionne  
I Cesoi e universa e  
E Podadera universa  
CN 剪枝剪



TRY ME  
HALF BLISTER  
CARD

<b>YATO</b>	L (mm)	
YT-8843	180	5/60

GB By-pass pruner  
D Rebenschere  
PL Seka or uniwersa n  
RUS Секатор  
CZ Nožnice zahradnicke  
H Me szoo ó

RO Foarfece pt. pomi  
F S ca eur radi ionne  
I Cesoi e universa e  
E Podadera universa  
CN 剪枝剪



TRY ME  
HALF BLISTER  
CARD

<b>YATO</b>	L (mm)	
YT-8849	200	12/72

GB Professional anvil pruner  
D mboss-Gar enschere  
PL Sekator kowadełkowy  
RUS Секатор  
CZ Nožnice zahradnicke  
H Me szoo ó

RO Foarfece pt. pomi  
F S ca eur à enc ume  
I Cesioie anvi  
E Podadera  
de bi ornia  
CN 棘轮剪枝剪

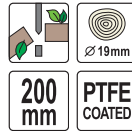

200 mm PTFE COATED



TRY ME  
HALF BLISTER  
CARD

YATO	L (mm)	
YT-8802	200	12/72

hi h carbon see bades

GB Ratchet by-pass pruner  
D Gar enschere  
PL Sekator z grzechotką  
RUS Секатор  
CZ Nožnice zahradnicke  
H Me szoo ó

RO Foarfece pt. pomi  
F S ca eur à ci ue  
I Cesioie con cricche o  
E Podadera  
con carraca  
CN 棘轮剪枝剪



200 mm SK5 PTFE COATED



TRY ME HALF  
BLISTER CARD

YATO	L (mm)	
YT-8808	200	12/72

GB Professional anvil pruner  
D mboss-Gar enschere  
PL Sekator kowadełkowy  
RUS Секатор  
CZ Nožnice zahradnicke  
H Me szoo ó

RO Foarfece pt. pomi  
F S ca eur à enc ume  
I Cesioie anvi  
E Podadera  
de bi ornia  
CN 棘轮剪枝剪



210 mm SK5 PTFE COATED



TRY ME  
HALF BLISTER  
CARD

YATO	L (mm)	
YT-8809	210	12/72

GB Professional anvil pruner  
D B moss-Gar enschere  
PL Sekator kowadełkowy  
RUS Секатор  
CZ Nožnice zahradnicke  
H Me szoo ó

RO Foarfece pt. pomi  
F S ca eur à enc ume  
I Cesioie anvi  
E Podadera  
de bi ornia  
CN 棘轮剪枝剪

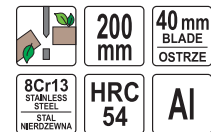

200 mm 40 mm BLADE OSTRZE  
8Cr13 STAINLESS STEEL STAL NERDZEWNA HRC 54 AI



SLIDING  
CARD

YATO	L (mm)	
YT-8792	200	12/60

GB Ratchet by-pass pruner  
D Gar enschere  
PL Sekator z grzechotką  
RUS Секатор  
CZ Nožnice zahradnicke  
H Me szoo ó

RO Foarfece pt. pomi  
F S ca eur à ci ue  
I Cesioie con cricche o  
E Podadera  
con carraca  
CN 棘轮剪枝剪



200 mm SK5 PTFE COATED



TRY ME  
HALF BLISTER  
CARD

YATO	L (mm)	
YT-8807	200	12/72

GB Fruit and flower shears  
D B umen- und Rebschere  
PL Sekator do obcinania zawiązków  
RUS Секатор  
CZ Nožnice zahradnicke  
H Me szoo ó

RO Foarfece pt. pomi  
F S ca eur  
I Cesioia a io emme  
E Podadera para cor ar ermenes  
CN 花枝剪

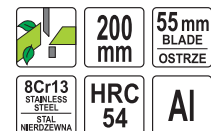

200 mm 55 mm BLADE OSTRZE  
8Cr13 STAINLESS STEEL STAL NERDZEWNA HRC 54 AI



SLIDING  
CARD

YATO	L (mm)	
YT-8791	200	12/60

GB Fruit and flower shears  
D B umen- und Rebschere  
PL Sekator do obcinania zawiązków  
RUS Секатор  
CZ Nožnice zahradnicke  
H Me szoo ó

RO Foarfece pt. pomi  
F S ca eur  
I Cesioia a io emme  
E Podadera para cor ar ermenes  
CN 花枝剪



180 mm SK5



SLIDING  
CARD

YATO	L (mm)	
YT-8815	180	12/72

GB Fruit and flower shears  
D B umen- und Rebschere  
PL Sekator do obcinania zawiązków  
RUS Секатор  
CZ Nožnice zahradnicke  
H Me szoo ó

RO Foarfece pt. pomi  
F S ca eur  
I Cesioia a io emme  
E Podadera para cor ar ermenes  
CN 花枝剪



190 mm SK5



SLIDING  
CARD

YATO	L (mm)	
YT-8816	190	12/72

GB Fruit and flower shears  
D Blumen- und Rebschere  
PL Seka or do obcinania zawiązków  
RUS Секатор  
CZ Nožnice zahradnicke  
H Me szoo ó

RO Foarfece pt. pomi  
F S ca eur  
I Cesoa a io emme  
E Podadera para cor ar ermenes  
CN 花枝剪



YATO	L (mm)	
YT-8817	190	12/72

GB Fruit and flower shears  
D Blumen- und Rebschere  
PL Seka or do obcinania zawiązków  
RUS Секатор  
CZ Nožnice zahradnicke  
H Me szoo ó

RO Foarfece pt. pomi  
F S ca eur  
I Cesoa a io emme  
E Podadera para cor ar ermenes  
CN 花枝剪



YATO	L (mm)	
YT-8850	200	12/72

GB By-pass lopping shears  
D s schere  
PL Sekator do gałęzi  
RUS Сучкорез  
CZ Nožnice zahradnicke  
H Ágvágó fix  
RO Foarfeca curbata pt. taiat crengi

F Coupe-branches à ame franche  
I Cesoa a iarami  
E Podadera para ramas  
CN 高枝剪

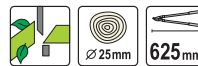

YATO	L (mm)	
YT-8831	625	12

# 1050 mid carbon steel blades

GB Anvil lopping shears  
D mboss s schere  
PL Sekator kowadelkowy do gałęzi  
RUS Сучкорез  
CZ Nožnice zahradnicke  
H Ágvágó fix  
RO Foarfeca curbata pt. taiat crengi

F Coupe-branches à cume  
I Cesoa anvi a iarami  
E Podadera para ramas, de bi ornia  
CN 高枝剪



YATO	L (mm)	
YT-8832	635	12

# 1050 mid carbon steel blades

GB By-pass lopping shears  
D s schere  
PL Sekator do gałęzi  
RUS Сучкорез  
CZ Nožnice zahradnicke  
H Ágvágó fix  
RO Foarfeca curbata pt. taiat crengi

F Coupe-branches à ame franche  
I Cesoa a iarami  
E Podadera para ramas  
CN 高枝剪

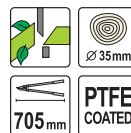

YATO	L (mm)	
YT-8833	705	12

# 1050 mid carbon steel blades

GB Anvil lopping shears  
D mboss s schere  
PL Sekator kowadelkowy do gałęzi  
RUS Сучкорез  
CZ Nožnice zahradnicke  
H Ágvágó fix  
RO Foarfeca curbata pt. taiat crengi

F Coupe-branches à cume  
I Cesoa anvi a iarami  
E Podadera para ramas, de bi ornia  
CN 高枝剪



YATO	L (mm)	
YT-8834	700	12

# 1050 mid carbon steel blades

GB By-pass lopping shears  
D s schere  
PL Sekator do gałęzi  
RUS Сучкорез  
CZ Nožnice zahradnicke  
H Ágvágó fix  
RO Foarfeca curbata pt. taiat crengi

F Coupe-branches à ame franche  
I Cesoa a iarami  
E Podadera para ramas  
CN 高枝剪

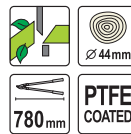

YATO	L (mm)	
YT-8835	780	12

# 1050 mid carbon steel blades

GB Anvil lopping shears  
D mboss s schere  
PL Sekator kowadelkowy do gałęzi  
RUS Сучкорез  
CZ Nožnice zahradnicke  
H Ágvágó fix  
RO Foarfeca curbata pt. taiat crengi

F Coupe-branches à cume  
I Cesoa anvi a iarami  
E Podadera para ramas, de bi ornia  
CN 高枝剪



YATO	L (mm)	
YT-8836	770	12

# 1050 mid carbon steel blades



GB Telescopic by-pass lopping shears  
D s schere  
PL Sekator teleskopowy do gałęzi  
RUS Секатор с телескопическими ручками  
CZ Nožnice zahradnicke  
H Ágvágó teleszkópos

RO Foarfeca curbata pt. taiat crengi  
F Coupe-branches télescopique  
I Cesioie tagliarami telescopica  
E Podadera telescópica para ramas  
CN 可伸缩高枝剪

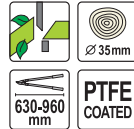

**PTFE COATED**



HANGING CARD & POUCH ON BLADE

YATO	L (mm)	Box
YT-8838	630-960	6/12

mid carbon steel blades

GB Telescopic by-pass lopping shears  
D s schere  
PL Sekator teleskopowy do gałęzi  
RUS Секатор с телескопическими ручками  
CZ Nožnice zahradnicke  
H Ágvágó teleszkópos

RO Foarfeca curbata pt. taiat crengi  
F Coupe-branches télescopique  
I Cesioie tagliarami telescopica  
E Podadera telescópica para ramas  
CN 可伸缩高枝剪



**PTFE COATED**



HANGING CARD & POUCH ON BLADE

YATO	L (mm)	Box
YT-8839	650-900	6

GB Telescopic by-pass lopping shears  
D s schere  
PL Sekator teleskopowy do gałęzi  
RUS Секатор с телескопическими ручками  
CZ Nožnice zahradnicke  
H Ágvágó teleszkópos

RO Foarfeca curbata pt. taiat crengi  
F Coupe-branches télescopique  
I Cesioie tagliarami telescopica  
E Podadera telescópica para ramas  
CN 可伸缩高枝剪

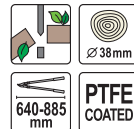

**PTFE COATED**



HANGING CARD & POUCH ON BLADE

YATO	L (mm)	Box
YT-8840	640-885	12

GB Telescopic by-pass lopping shears  
D s schere  
PL Sekator teleskopowy do gałęzi  
RUS Секатор с телескопическими ручками  
CZ Nožnice zahradnicke  
H Ágvágó teleszkópos

RO Foarfeca curbata pt. taiat crengi  
F Coupe-branches télescopique  
I Cesioie tagliarami telescopica  
E Podadera telescópica para ramas  
CN 可伸缩高枝剪



**PTFE COATED**



HANGING CARD & POUCH ON BLADE

YATO	L (mm)	Box
YT-8841	690-930	6

GB Telescopic by-pass lopping shears  
D s schere  
PL Sekator teleskopowy do gałęzi  
RUS Секатор с телескопическими ручками  
CZ Nožnice zahradnicke  
H Ágvágó teleszkópos

RO Foarfeca curbata pt. taiat crengi  
F Coupe-branches télescopique  
I Cesioie tagliarami telescopica  
E Podadera telescópica para ramas  
CN 可伸缩高枝剪

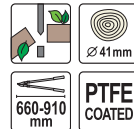

**PTFE COATED**



HANGING CARD & POUCH ON BLADE

YATO	L (mm)	Box
YT-8842	660-910	12

GB Leverage tree pruner  
D Baumsä emi as schere  
PL Sekator gąsienicowy z piłą  
RUS Сучкорез штанговый с пилой  
CZ Stříhač na větve s pilovým listem  
H Köes á vá ó  
RO Fierastrau pt. porni cu prelungitor  
F Système de scie à poulie  
I Taglio pista con sega  
E Podadera de palanca con sierra  
CN 高枝锯



**PTFE COATED**



DOUBLE BLISTER

YATO	L (mm)	Box
YT-8876	325	12

GB Bow saw  
D Besäe  
PL Pila kablakowa  
RUS Лучковая пила  
CZ Oblouková pila  
H Keretes fűrész

RO Ferăstrău de curbură  
F Scie à bches  
I Se a ad arco  
E Sierra de arco  
CN 两用弓锯

COLOR SLEEVE



HCS 65



2  
FUNCTION

FOR WOOD AND METAL  
DO DREWNA I METALU

FOR WOOD  
DO DREWNA

YATO	L (mm)	
YT-3200	300	12/24

YATO	L (mm)	
YT-3201	450	12/24
YT-3202	530	
YT-3203	610	
YT-3204	760	

GB Bade for dr wood  
D Trockenholzsaebaf r Handsäe  
PL Brzeczco do drewna suche o  
RUS Лезвие для работы по сухому дереву  
CZ Pilový list na suché dřevo

H Fűrészlap száraz fához  
RO Lama pt. lemn uscat  
F lame à bois sec  
I Lama per il legno secco  
E Hoja de sierra para madera seca  
CN 干木锯条

HCS 65

DRY WOOD  
DREWNO SUCHE



COLOR SLEEVE

YATO	L (mm)	
YT-3221	450	50/200
YT-3222	530	
YT-3223	610	
YT-3224	760	

GB Bade for we wood  
D Nassholzsaebaf r Handsäe  
PL Brzeczco do drewna mokre o  
RUS Лезвие для работы по влажному дереву  
CZ Pilový list na mokré dřevo

H Fűrészlap nedves fához  
RO Lama pt. lemn verde  
F lame à bois humide  
I Lama per il legno bagnato  
E Hoja de sierra para madera mojada  
CN 湿木锯条

HCS 65

WET WOOD  
DREWNO MOKRE



COLOR SLEEVE

YATO	L (mm)	
YT-3230	300	50/200
YT-3231	450	
YT-3232	530	
YT-3233	610	
YT-3234	760	

GB e  
D Bei Hicor sie  
PL Siekiera

RUS Tonop  
CZ Sekerka  
H Szekerce

RO Secure  
F Hache  
I scia

E Hacha  
CN 把斧

DIN 5131  
7294

GENUINE HICKORY

Timber wedge and steel ring      Genuine hickory shaft



Forged carbon steel head hardened and tempered

YATO	m ( )	L (mm)	DIN	
YT-8001	600	360	5131	24
YT-8002	800	380	5131	20
YT-8003	1000	430	5131	12
YT-8004	1250	710	7294	12
YT-8005	1400	710	7294	12
YT-8006	1600	810	7294	12

GB e  
D Bei Hicor sie  
PL Siekiera

RUS Tonop  
CZ Sekerka  
H Szekerce

RO Secure  
F Hache  
I scia

E Hacha  
CN 把斧

GENUINE HICKORY

Timber wedge and steel ring      Genuine hickory shaft



Forged carbon steel head hardened and tempered

YATO	m ( )	L (mm)	
YT-8011	1000	515	6
YT-8012	2000	820	6

GB Transplanter  
D Bumenke e  
PL Łopatka  
RUS Сокoк посадочный  
CZ Lopatka  
H só  
RO Mini-lopatá gradinarit  
F Transplantoir  
I Spatola  
E Pa e a es recha  
CN 移植器

**350 mm**

**CARBON STEEL**



YATO	L (mm)	
YT-8865	350	10/60

GB Rake  
D Bumenrechen  
PL Grabki  
RUS Грабли  
CZ Hraabičky  
H Gereb e  
RO Mini reb a  
F Râteau  
I Ras re i  
E Ras rí o  
CN 园艺耙

**325 mm**

**CARBON STEEL**



YATO	L (mm)	
YT-8866	325	10/60

GB 3-ine fork rake  
D Keinacke  
PL Motyczka + pazurki  
RUS Рыхлитель комбинированный  
CZ Motyčka s kultivátorem  
H Kapa és kultivátor  
RO Sapaliga + cultivator  
F Rateau et bêche  
I Zappa + artigli  
E Escarificador tres dienes con azadi a  
CN 园艺耙

**310 mm**

**CARBON STEEL**



YATO	L (mm)	
YT-8867	310	10/60

GB Cu iva or  
D Grubber  
PL Pazurki  
RUS Рыхлитель  
CZ Ku ívá or  
H Ku ívá or  
RO Cu íva or  
F Griffe piocheuse  
I rri  
E Escarificador  
CN 园艺耙

**420 mm**

**CARBON STEEL**



YATO	L (mm)	
YT-8868	420	10/60

GB Garden rake  
D andschaf sbesen  
PL Grabki wach arzowe  
RUS Грабли веерные  
CZ Hraabičky  
H Keri ereb e  
RO Greb a de radina  
F Râteau  
I Ras re i ven í a ore  
E Ras rí o de abanico de hojalata  
CN 园艺耙

**400 mm**

**CARBON STEEL**



YATO	L (mm)	
YT-8869	400	10/60

GB Transplanter  
D Bumenke e  
PL Łopatka  
RUS Сокoк посадочный  
CZ Lopatka  
H só  
RO Mini-lopatá gradinarit  
F Transplantoir  
I Spatola  
E Pa e a es recha  
CN 移植器

**360 mm**

**CARBON STEEL**



YATO	L (mm)	
YT-8870	360	10/60

GB Transplanter  
D Bumenke e  
PL Łopatka  
RUS Сокoк посадочный  
CZ Lopatka  
H só  
RO Mini-lopatá gradinarit  
F Transplantoir  
I Spatola  
E Pa e a es recha  
CN 移植器

**340 mm**

**CHROME PLATED**



YATO	L (mm)	
YT-8885	340	12/72

GB Transplanter  
D Bumenke e  
PL Łopatka  
RUS Сокoк посадочный  
CZ Lopatka  
H só  
RO Mini-lopatá gradinarit  
F Transplantoir  
I Spatola  
E Pa e a es recha  
CN 移植器

**340 mm**

**CHROME PLATED**



YATO	L (mm)	
YT-8886	340	12/72

GB Hoe  
D Gar en handhacke  
PL Mo czka  
RUS Мотыжка  
CZ Motyčka  
H Kerti kapa  
RO Sapaliga  
F Bine e  
I Zappetta  
E zadi a  
CN 园艺锄

**280 mm**

**CHROME PLATED**



YATO	L (mm)	
YT-8889	280	12/72

GB Cu iva or  
D Grubber  
PL Pazurki  
RUS Рыхлитель  
CZ Ku ívá or  
H Ku ívá or  
RO Cu íva or  
F Griffe piocheuse  
I rri  
E Escarificador  
CN 园艺耙

**270 mm**

**CHROME PLATED**



YATO	L (mm)	
YT-8890	270	12/72

GB Ro in i er  
D Rollpflüger  
PL Spulnhiacz  
RUS Рыхлитель дисковый  
CZ Kypřič púdy  
H Görgös talajlazító  
RO Maruntitor pt. pamant  
F mie eur  
I Co íva ore  
E Escarificador  
CN 松土器

**370 mm**

**CHROME PLATED**



YATO	L (mm)	
YT-8891	370	12/72

GB Hoe + cultivator  
D Keinacke  
PL Motyczka z pazurkami  
RUS Рыхлитель комбинированный  
CZ Motyčka s hraabičkami  
H Kerti villás kapa  
RO Sapaliga + cultivator  
F Serfoue e  
I Zappetta con artigli  
E zadi a con escarificador  
CN 园艺锄

**320 mm**

**CHROME PLATED**



YATO	L (mm)	
YT-8892	320	12/72

- GB Dibbe
- D Pflanzler
- PL Pikownik o rodnicz
- RUS Конус посадочный с деревянной ручкой
- CZ Zahradnický přepichovač
- H Kerti palántázó
- RO Chitonag pt. grădină
- F P an oir
- I Foraterra
- E Picadeor de jardín
- CN 挖洞器



280 mm

STAINLESS STEEL  
STAL  
NERDZEWA

YATO	L (mm)	
YT-8894	280	10/60

- GB Bow saw
- D B e sä e
- PL Pila kablakowa
- RUS Лучковая пила
- CZ Oblouková pila
- H Keretes fűrész
- RO Ferăstrău de curbură
- F Scie à b ches
- I Se a ad arco
- E Sierra de arco
- CN 两用弓锯



COLOR SLEEVE



HCS 65

2 FUNCTION FOR WOOD AND METAL DO DREWNA I METALU

YATO	L (mm)	
YT-3200	300	12/24



FOR WOOD DO DREWNA

YATO	L (mm)	
YT-3201	450	12/24
YT-3202	530	
YT-3203	610	
YT-3204	760	

- GB B ade for dr wood
- D Trockenho zsä eb a f r Handsä e
- PL Brzeszczo do drewna suche o
- RUS Лезвие для работы по сухому дереву
- CZ Pilový list na suché dřevo

- H Fűrészlap száraz fához
- RO Lama pt. lemn uscat
- F lame à bois sec
- I Lama per il legno secco
- E Hoja de sierra para madera seca
- CN 干木锯条

HCS 65

DRY WOOD DREWNO SUCHE



COLOR SLEEVE



YATO	L (mm)	
YT-3221	450	50/200
YT-3222	530	
YT-3223	610	
YT-3224	760	

- GB B ade for we wood
- D Nassho zsä eb a f r Handsä e
- PL Brzeszczo do drewna mokre o
- RUS Лезвие для работы по влажному дереву
- CZ Pilový list na mokré dřevo

- H Fűrészlap nedves fához
- RO Lama pt. lemn verde
- F lame à bois humide
- I Lama per il legno bagnato
- E Hoja de sierra para madera mojada
- CN 湿木锯条

HCS 65

WET WOOD DREWNO MOKRE



COLOR SLEEVE



YATO	L (mm)	
YT-3230	300	50/200
YT-3231	450	
YT-3232	530	
YT-3233	610	
YT-3234	760	



GB Spade  
D Rodespaten  
PL Szpadel  
RUS Застып  
CZ Lisovaný rýč kalená  
H Ásó, sajtoit-edzett  
RO Hârleț cu coadă  
F Bêche à bord pointu  
I Spatola  
E Pa a  
CN 铲

**120**  
cm

**HRC**  
40-48

**1050Mn**  
STEEL



<b>YATO</b> 	L (cm)	
YT-86804	120	6



GB Spade  
D Rodespaten  
PL Szpadel  
RUS Застып  
CZ Lisovaný rýč kalená  
H Ásó, sajtoit-edzett  
RO Hârleț cu coadă  
F Bêche à bord droit  
I Spatola  
E Pa a  
CN 铲

**120**  
cm

**HRC**  
40-48

**1050Mn**  
STEEL



<b>YATO</b> 	L (cm)	
YT-86800	120	6



GB Shove  
D Schaufe  
PL Łopata  
RUS Лопата  
CZ Osazený rýč  
H Homoklapát, ékelt  
RO Lopată pt. nisip  
F Pe e à charbon  
I Pa a  
E Pa a  
CN 鏟子

**120**  
cm

**HRC**  
40-48

**1050Mn**  
STEEL



<b>YATO</b> 	L (cm)	
YT-86801	120	6



GB Shove  
D Schaufe  
PL Łopata ogrodnicza  
RUS Лопата совковая  
песочная  
CZ Osazený  
rýč pískový  
H Homoklapát, ékelt  
RO Lopată pt. nisip  
F Pe e à sab e  
I Pa a  
E Pa a  
CN 鏟子

**120**  
cm

**HRC**  
40-48

**1050Mn**  
STEEL





<b>YATO</b> 	L (cm)	
YT-86808	120	6

GB Di in fork  
D Profi-grabegabel  
PL Widły  
RUS Вилы  
CZ Zahradnick vidice  
H asví a  
RO Furcă pt. grădinărit  
F Fourche à bêcher  
I Forchetta  
E Horca  
CN 铁叉

**120**  
cm

**65 Mn**  
STEEL





<b>YATO</b> 	L (cm)	
YT-8603	120	3

GB Di in fork  
D Profi-grabegabel  
PL Widły  
RUS Вилы  
CZ Zahradnick vidice  
H asví a  
RO Furcă pt. grădinărit  
F Fourche à bêcher  
I Forchetta  
E Horca  
CN 铁叉

**120**  
cm





<b>YATO</b> 	L (cm)	
YT-86805	120	6

GB Di in fork  
D Profi-grabegabel  
PL Widły  
RUS Вилы  
CZ Zahradnick vidice  
H asví a  
RO Furcă pt. grădinărit  
F Fourche à bêcher  
I Forchetta  
E Horca  
CN 铁叉

**120**  
cm



<b>YATO</b> 	L (cm)	
YT-86809	120	6

YATO	page/strona	YATO	page/strona	YATO	page/strona	YATO	page/strona	YATO	page/strona	YATO	page/strona	YATO	page/strona	YATO	page/strona
YT-0006	7	YT-0118	13	YT-0204	9	YT-0320	33	YT-0380	12	YT-0453	74	YT-0501	116	YT-06019	338
YT-0007	7	YT-0119	13	YT-0205	9	YT-0321	38	YT-0381	12	YT-0454	74	YT-0502	116	YT-0602	319
YT-0008	7	YT-0120	13	YT-0206	9	YT-0322	29	YT-0383	14	YT-0455	74	YT-0503	116	YT-0603	322
YT-0009	7	YT-0122	13	YT-0207	15	YT-0323	33	YT-0384	14	YT-0456	74	YT-0504	116	YT-0604	351
YT-0010	7	YT-0123	13	YT-0208	9	YT-0324	38	YT-0385	14	YT-0457	74	YT-0505	116	YT-0605	355
YT-0011	7	YT-0125	13	YT-0209	15	YT-0325	29	YT-0386	14	YT-0459	111	YT-0506	116	YT-0606	333
YT-0012	7	YT-0127	13	YT-0211	15	YT-0326	33	YT-0387	14	YT-0461	74	YT-0507	116	YT-0607	333
YT-0013	7	YT-0128	13	YT-0213	15	YT-0327	38	YT-0388	14	YT-0465	113	YT-0508	116	YT-0608	333
YT-0014	7	YT-0132	13	YT-0215	15	YT-0331	30	YT-0389	14	YT-0466	113	YT-0509	116	YT-0609	319
YT-0015	7	YT-0135	18	YT-0217	15	YT-03311	30	YT-0390	14	YT-0467	113	YT-0511	117	YT-0610	351
YT-0016	7	YT-0136	18	YT-0219	15	YT-0332	12	YT-0391	14	YT-0468	113	YT-0512	117	YT-0611	352
YT-0017	7	YT-0137	18	YT-0222	15	YT-0333	12	YT-0392	14	YT-0470	109	YT-0519	117	YT-0612	324
YT-0018	7	YT-0138	18	YT-0223	15	YT-0334	12	YT-0394	14	YT-04702	108	YT-0520	70	YT-0613	324
YT-0019	7	YT-01385	18	YT-0227	15	YT-0335	6	YT-0396	15	YT-0471	109	YT-0521	70	YT-0614	324
YT-0020	7	YT-0139	18	YT-0228	15	YT-0336	6	YT-0398	15	YT-04712	108	YT-05211	70	YT-0615	324
YT-0021	7	YT-0140	18	YT-0232	15	YT-0337	6	YT-0400	112	YT-0472	109	YT-05212	70	YT-06155	324
YT-0022	7	YT-0143	18	YT-02330	15	YT-0338	6	YT-0404	108	YT-04722	108	YT-05213	70	YT-06157	325
YT-0023	7	YT-0150	13	YT-02331	15	YT-0339	6	YT-0405	108	YT-0473	109	YT-05214	70	YT-0616	325
YT-0024	7	YT-0152	13	YT-02332	15	YT-0340	6	YT-04051	108	YT-0474	109	YT-05215	70	YT-06160	324
YT-0025	7	YT-0156	11	YT-02333	15	YT-0341	6	YT-04052	108	YT-04742	108	YT-05220	70	YT-06161	331
YT-0026	7	YT-0158	11	YT-02334	15	YT-0342	6	YT-0406	108	YT-0475	109	YT-05221	70	YT-0617	341
YT-0027	7	YT-0159	11	YT-0248	16	YT-0343	6	YT-0407	108	YT-04752	108	YT-05222	70	YT-0618	341
YT-0028	7	YT-0162	11	YT-0250	16	YT-0344	6	YT-0408	108	YT-0476	109	YT-05223	70	YT-0619	356
YT-0030	7	YT-0163	11	YT-0252	16	YT-0345	6	YT-0409	108	YT-04762	108	YT-05224	70	YT-0620	323
YT-0032	7	YT-0170	18	YT-0256	10	YT-0346	6	YT-0410	112	YT-0477	109	YT-05225	70	YT-06205	334
YT-0036	7	YT-0171	18	YT-0272	11	YT-0347	6	YT-0411	112	YT-04772	108	YT-05226	70	YT-0621	356
YT-0038	7	YT-0172	18	YT-0276	11	YT-0348	6	YT-0412	112	YT-0478	109	YT-05227	70	YT-0622	343
YT-0041	7	YT-0173	18	YT-0279	11	YT-0349	6	YT-0413	112	YT-04782	108	YT-05228	70	YT-0623	323
YT-0046	7	YT-0175	18	YT-0280	11	YT-0350	6	YT-0414	112	YT-0479	109	YT-0530	19	YT-0624	323
YT-0050	7	YT-0180	19	YT-0284	18	YT-0351	6	YT-0415	112	YT-04792	108	YT-0534	349	YT-0627	337
YT-0055	7	YT-0181	19	YT-0286	18	YT-0352	6	YT-0416	112	YT-0480	109	YT-0539	337	YT-06271	332
YT-0060	7	YT-0184	19	YT-0287	18	YT-0353	6	YT-0417	112	YT-0481	109	YT-0540	337	YT-06273	337
YT-0062	7	YT-0185	19	YT-0290	29	YT-0354	6	YT-0418	112	YT-04812	108	YT-0546	114	YT-0628	356
YT-0065	7	YT-0186	19	YT-0291	33	YT-0355	6	YT-0419	112	YT-0482	109	YT-0560	117	YT-06291	328
YT-0067	7	YT-0187	19	YT-0292	38	YT-0356	6	YT-0420	112	YT-04822	108	YT-0561	117	YT-0630	333
YT-0075	7	YT-0189	9	YT-0293	29	YT-0357	6	YT-0421	346	YT-0483	109	YT-0562	117	YT-06311	350
YT-00760	6	YT-0190	19	YT-0294	33	YT-0358	6	YT-04211	346	YT-04832	108	YT-0563	117	YT-0632	338
YT-00761	6	YT-01906	9	YT-0295	38	YT-0359	6	YT-0430	74	YT-0484	111	YT-0585	323	YT-0633	340
YT-00762	6	YT-01907	9	YT-0297	30	YT-0360	6	YT-0431	74	YT-0485	108	YT-0590	322	YT-0635	338
YT-00763	6	YT-01908	9	YT-0298	34	YT-0362	6	YT-0432	74	YT-0486	108	YT-0591	322	YT-0636	338
YT-00764	6	YT-01909	9	YT-0299	39	YT-0363	6	YT-0433	74	YT-0487	108	YT-0593	89 349	YT-0637	338
YT-00765	6	YT-0191	9	YT-0307	29	YT-0365	6	YT-0434	74	YT-0488	111	YT-0594	312	YT-0638	326
YT-00766	6	YT-0192	9	YT-0308	33	YT-0367	12	YT-0435	74	YT-0489	111	YT-0595	311	YT-0639	334
YT-00767	6	YT-0193	9	YT-0309	38	YT-0368	12	YT-0436	74	YT-0490	111	YT-0596	312	YT-0640	320
YT-00768	6	YT-0194	9	YT-0310	29	YT-0369	12	YT-0437	74	YT-0491	111	YT-0598	313	YT-0641	320
YT-00769	6	YT-0195	9	YT-0311	33	YT-0370	12	YT-0438	74	YT-0492	111	YT-0599	313	YT-0642	325
YT-0107	13	YT-0196	9	YT-0312	38	YT-0371	12	YT-0439	74	YT-0493	111	YT-0600	313	YT-0643	357
YT-0109	13	YT-0197	9	YT-0313	29	YT-0372	12	YT-0440	74	YT-0494	111	YT-0601	338	YT-0644	357
YT-0110	13	YT-0198	9	YT-0314	33	YT-0373	12	YT-0441	74	YT-0495	111	YT-06011	338	YT-0645	334
YT-0111	13	YT-0199	9	YT-0315	38	YT-0374	12	YT-0442	74	YT-0496	111	YT-06012	339	YT-0646	335
YT-0112	13	YT-0200	9	YT-0316	29	YT-0375	12	YT-0443	74	YT-0497	111	YT-06013	340	YT-0647	335
YT-0113	13	YT-0201	9	YT-0317	33	YT-0376	12	YT-0450	74	YT-0498	111	YT-06014	339	YT-06475	337
YT-0115	13	YT-0202	9	YT-0318	38	YT-0377	12	YT-0451	74	YT-0499	111	YT-06015	341	YT-0648	336
YT-0117	13	YT-0203	9	YT-0319	29	YT-0378	12	YT-0452	74	YT-0500	116	YT-06016	340	YT-0650	335

YATO	page/strona	YATO	page/strona	YATO	page/strona	YATO	page/strona	YATO	page/strona	YATO	page/strona	YATO	page/strona	YATO	page/strona
YT-0651	335	YT-0708	316	YT-0830	360	YT-09061	300	YT-09746	218 280	YT-1045	79	YT-1129	81	YT-1210	35
YT-0652	335	YT-0709	316	YT-08305	361	YT-0907	307	YT-09747	218 280	YT-1046	79	YT-1130	81	YT-1211	35
YT-0653	336	YT-0710	316	YT-0831	361	YT-09071	307	YT-09748	218 280	YT-1047	79	YT-1132	81	YT-1212	35
YT-0657	333	YT-07115	317	YT-0835	361	YT-09072	307	YT-09749	218 280	YT-1048	79	YT-1133	81	YT-1213	35
YT-0659	332	YT-0712	317	YT-0836	331	YT-0908	307	YT-09750	218 280	YT-1049	79	YT-1134	81	YT-1214	35
YT-06590	332	YT-0715	317	YT-0837	331	YT-0910	307	YT-0976	280	YT-1050	79	YT-1135	81	YT-1215	35
YT-0660	359	YT-0716	367	YT-0838	327	YT-09101	308	YT-0977	280	YT-1052	79	YT-1136	81	YT-1216	35
YT-0661	360	YT-0717	367	YT-08380	326	YT-09102	308	YT-0980	279	YT-1054	79	YT-1138	81	YT-1217	35
YT-06611	360	YT-0718	367	YT-08385	327	YT-09107	308	YT-0981	279	YT-1055	79	YT-1141	81	YT-1218	35
YT-0662	360	YT-0720	30	YT-0840	348	YT-09108	308	YT-0982	279	YT-1056	357	YT-1142	81	YT-1219	35
YT-0663	359	YT-0722	39	YT-0841	330	YT-0911	307	YT-0990	281	YT-1060	80	YT-1143	81	YT-1220	35
YT-0670	344	YT-0726	358	YT-0842	330	YT-0912	298	YT-0993	281	YT-1061	80	YT-1146	81	YT-1221	36
YT-0671	353	YT-0730	30	YT-0843	95	YT-0913	298	YT-0994	281	YT-1062	80	YT-1148	81	YT-1222	36
YT-0672	347	YT-0731	34	YT-08430	328	YT-0914	298	YT-1000	78	YT-1064	80	YT-1150	81	YT-1223	36
YT-06722	369	YT-0732	39	YT-0844	331	YT-09151	296	YT-1001	78	YT-1065	84	YT-1155	82	YT-1224	36
YT-0673	348	YT-0733	30	YT-0845	332	YT-09152	296	YT-1002	78	YT-1066	84	YT-1157	84	YT-1225	36
YT-0674	348	YT-0734	34	YT-0846	332	YT-09155	296	YT-1003	78	YT-1067	80	YT-1160	82	YT-1226	36
YT-0677	336	YT-0735	39	YT-0847	331	YT-0920	240 287	YT-1004	78	YT-1068	84	YT-1161	82	YT-1227	36
YT-0680	351	YT-0750	88	YT-08502	362 435	YT-0921	240 287	YT-1005	78	YT-1069	84	YT-1162	82	YT-1228	36
YT-0681	352	YT-0751	88	YT-08503	364 437	YT-0923	240 287	YT-1006	78	YT-1070	81	YT-1163	82	YT-1229	36
YT-0682	353	YT-0754	88	YT-08505	363 436	YT-0925	241 287	YT-1007	78	YT-1071	81	YT-1164	82	YT-1230	36
YT-06822	354	YT-0755	88	YT-08513	362 435	YT-0927	241	YT-1008	78	YT-1072	81	YT-11671	82	YT-1231	36
YT-0683	351	YT-0760	88	YT-08514	362 435	YT-0929	241	YT-1009	78	YT-1073	81	YT-1168	82	YT-1232	36
YT-0684	350	YT-0761	88	YT-0852	363 436	YT-0930	241	YT-1010	78	YT-1074	81	YT-1169	83	YT-1233	36
YT-0685	350	YT-0770	88	YT-08523	363 436	YT-0931	241	YT-1011	78	YT-1075	81	YT-1175	83	YT-1234	36
YT-0686	350	YT-0771	88	YT-08530	364 437	YT-0932	241	YT-1012	78	YT-1076	81	YT-1176	83	YT-1235	36
YT-06871	376	YT-0781	89	YT-08531	363 436	YT-0935	241	YT-1013	78	YT-1077	81	YT-1177	83	YT-1236	36
YT-06877	376	YT-0782	89	YT-08561	362 435	YT-0936	241	YT-1014	78	YT-1078	81	YT-1178	83	YT-1237	36
YT-06880	377	YT-07822	89	YT-0860	360	YT-0937	241	YT-1015	78	YT-1079	81	YT-1179	83	YT-1238	36
YT-06881	377	YT-0795	357	YT-0862	168 385	YT-0938	241	YT-1016	78	YT-1080	81	YT-1180	83	YT-1239	36
YT-06888	376	YT-0796	357	YT-0863	168 385	YT-0939	241	YT-1017	78	YT-1082	81	YT-1182	83	YT-1240	36
YT-0690	317	YT-0800	358	YT-0864	168 385	YT-0940	241	YT-1018	78	YT-1083	81	YT-1183	83	YT-1241	37
YT-0691	317	YT-0801	358	YT-0865	168 385	YT-0941	241	YT-1019	78	YT-1084	81	YT-1184	83	YT-1242	37
YT-06912	317	YT-0802	358	YT-0866	168 385	YT-0942	241	YT-1020	78	YT-1085	81	YT-1185	83	YT-1243	37
YT-06913	317	YT-0803	358	YT-0867	168 385	YT-09501	276	YT-1022	78	YT-1086	81	YT-1186	83	YT-1244	37
YT-06914	317	YT-0807	358	YT-0870	168 385	YT-09505	276	YT-1025	78	YT-1088	81	YT-1187	83	YT-1246	36
YT-0692	367	YT-0808	358	YT-0880	361	YT-09511	276	YT-1027	84	YT-1091	81	YT-1188	83	YT-1247	36
YT-0693	367	YT-0809	358	YT-0882	309	YT-0952	276	YT-1028	84	YT-1092	81	YT-1189	83	YT-1248	36
YT-0694	367	YT-0810	358	YT-0883	309	YT-0953	277	YT-1029	84	YT-1093	81	YT-1191	83	YT-1249	36
YT-0695	367	YT-0811	358	YT-0884	309	YT-09540	277	YT-1030	79	YT-1096	81	YT-1193	83	YT-1250	36
YT-0696	367	YT-0812	349	YT-0885	309	YT-0956	277	YT-1031	79	YT-1098	81	YT-1194	83	YT-1251	36
YT-0697	367	YT-0813	350	YT-0886	309	YT-09571	277	YT-1032	79	YT-1100	81	YT-1195	83	YT-1252	37
YT-0699	367	YT-0814	350	YT-08920	300	YT-0959	278	YT-1033	79	YT-1102	81	YT-1196	83	YT-1253	37 349
YT-0700	314	YT-0817	349	YT-08921	306	YT-0960	278	YT-1034	79	YT-1105	81	YT-1197	83	YT-1254	37 349
YT-0701	314	YT-0818	349	YT-08922	306	YT-09611	278	YT-1035	79	YT-1110	81	YT-1198	83	YT-1255	37
YT-0704	315	YT-0819	349	YT-09000	299	YT-0965	279	YT-1036	79	YT-1115	81	YT-1201	35	YT-1258	37
YT-07041	315	YT-0820	311	YT-09001	297	YT-0967	279	YT-1037	79	YT-1119	81	YT-1202	35	YT-1259	37
YT-07042	314	YT-0821	311	YT-09002	297	YT-0970	281	YT-1038	79	YT-1121	81	YT-1203	35	YT-12621	57
YT-07043	314	YT-0822	311	YT-09003	297	YT-09702	281	YT-1039	79	YT-1122	81	YT-1204	35	YT-12641	58
YT-0705	314	YT-0823	311	YT-09008	299	YT-09741	280	YT-1040	79	YT-1123	81	YT-1205	35	YT-12651	58
YT-07055	286 315	YT-0824	311	YT-0902	298	YT-09742	280	YT-1041	79	YT-1124	81	YT-1206	35	YT-12661	58
YT-07061	316	YT-0825	311	YT-0903	298	YT-09743	218 280	YT-1042	79	YT-1125	81	YT-1207	35	YT-12671	58
YT-07063	316	YT-0826	311	YT-09031	299	YT-09744	218 280	YT-1043	79	YT-1127	81	YT-1208	35	YT-1268	63
YT-0707	316	YT-08295	360	YT-0904	299	YT-09745	218 280	YT-1044	79	YT-1128	81	YT-1209	35	YT-12681	44

YATO	page/strona	YATO	page/strona	YATO	page/strona	YATO	page/strona	YATO	page/strona	YATO	page/strona	YATO	page/strona	YATO	page/strona
YT-12682	64	YT-1340	71	YT-1429	27	YT-1515	113	YT-1604	17	YT-1665	10	YT-1767	183 365	YT-1949	128
YT-1269	63	YT-1341	71	YT-1430	27	YT-1517	113	YT-1605	17	YT-1666	10	YT-1768	183 365	YT-1950	127
YT-12691	44	YT-1342	71	YT-1431	27	YT-1518	113	YT-1606	17	YT-1667	10	YT-1769	183 365	YT-1951	127
YT-1270	35	YT-1345	72	YT-1432	27	YT-1530	113	YT-1607	17	YT-1668	10	YT-1781	78	YT-1952	127
YT-1271	35	YT-1347	72	YT-1433	27	YT-1531	113	YT-1608	17	YT-1669	10	YT-1792	78	YT-1953	127
YT-1272	35	YT-1348	72	YT-1434	27	YT-1532	113	YT-1609	17	YT-1670	10	YT-1795	78	YT-1954	127
YT-1273	35	YT-1350	71	YT-1435	27	YT-1533	113	YT-1610	17	YT-1671	10	YT-1797	78	YT-1956	127
YT-1274	35	YT-1352	71	YT-1436	27	YT-1534	113	YT-1611	17	YT-1672	10	YT-1799	78	YT-1960	190 386
YT-1275	35	YT-1355	71	YT-1437	28	YT-1535	113	YT-1612	17	YT-1673	10	YT-1843	192	YT-1961	190 387
YT-1276	35	YT-1356	37	YT-1438	28	YT-1537	113	YT-1613	17	YT-1674	11	YT-1844	192	YT-1962	190 386
YT-1277	35	YT-1360	72	YT-14411	51	YT-1539	113	YT-1614	17	YT-1675	11	YT-1845	192	YT-1963	189 388
YT-1278	35	YT-1370	329	YT-14421	51	YT-1541	21	YT-1615	17	YT-1676	11	YT-1846	192	YT-1964	189 388
YT-1279	35	YT-1371	329	YT-1443	51	YT-1542	21	YT-1616	17	YT-1677	11	YT-1847	192	YT-1965	189 388
YT-1280	35	YT-1372	329	YT-1444	52	YT-1543	21	YT-1617	17	YT-1678	11	YT-1848	192	YT-1966	147 189
YT-1281	35	YT-1373	329	YT-1445	52	YT-1544	21	YT-1618	17	YT-1679	11	YT-1851	192	YT-1967	147 189
YT-1282	35	YT-1374	329	YT-14451	40	YT-1545	21	YT-1619	17	YT-1680	11	YT-1852	192	YT-1968	147 189
YT-1283	35	YT-1375	329	YT-1446	53	YT-1546	21	YT-1620	17	YT-1681	11	YT-1853	192	YT-1969	147 189
YT-1284	35	YT-1376	329	YT-14461	40	YT-1547	21	YT-1621	17	YT-1682	11	YT-1854	192	YT-1970	189 388
YT-1285	35	YT-1378	329	YT-1447	53	YT-1548	21	YT-1622	17	YT-1683	11	YT-1855	192	YT-1974	146 207
YT-1286	35	YT-1379	329	YT-14471	40	YT-1549	21	YT-1627	19	YT-1684	11	YT-1856	192	YT-1976	193
YT-1289	35	YT-13790	329	YT-1448	53	YT-1552	22	YT-1628	19	YT-1685	11	YT-18600	147 193	YT-19763	207
YT-1291	35	YT-1381	329	YT-14481	41	YT-1553	22	YT-1629	19	YT-1686	11	YT-18602	147 193	YT-19764	207
YT-1292	35	YT-1382	330	YT-1449	52	YT-1554	22	YT-1630	19	YT-1687	11	YT-18610	147 193	YT-19765	207
YT-1295	37	YT-1385	330	YT-1450	54	YT-1555	22	YT-1631	19	YT-1688	11	YT-18611	147 193	YT-19766	207
YT-1296	32	YT-1390	330	YT-14501	41	YT-1556	22	YT-1632	19	YT-1689	11	YT-18612	147 193	YT-19767	207
YT-1297	28	YT-1391	330	YT-1460	35	YT-1557	22	YT-1633	19	YT-1690	11	YT-1900	191 256 387	YT-1988	130
YT-1301	71	YT-1392	330	YT-1461	35	YT-1558	22	YT-1634	19	YT-1691	11	YT-1901	191 256 387	YT-1989	130
YT-1302	71	YT-1400	28	YT-1462	35	YT-1559	22	YT-1635	19	YT-1692	11	YT-1902	191 256 387	YT-1990	130
YT-1303	71	YT-1401	27	YT-1463	35	YT-1565	22	YT-1636	19	YT-1694	11	YT-1910	190 386	YT-1991	130
YT-1304	71	YT-1403	27	YT-1464	35	YT-1566	22	YT-1637	19	YT-1696	11	YT-1911	190 387	YT-1992	130
YT-1305	71	YT-1404	27	YT-1465	35	YT-1567	22	YT-1638	19	YT-1702	368	YT-1912	190 386	YT-1993	130
YT-1306	71	YT-1405	27	YT-1466	35	YT-1571	22	YT-1639	19	YT-1704	368	YT-1913	191 256 386	YT-1994	130
YT-1307	71	YT-1406	27	YT-1467	35	YT-1572	22	YT-1640	19	YT-1706	368	YT-1914	191 256 387	YT-1995	130
YT-1308	71	YT-1407	27	YT-1468	35	YT-1573	22	YT-1641	19	YT-1707	368	YT-1915	190 386	YT-2006	121
YT-1309	71	YT-1408	27	YT-1469	35	YT-1574	22	YT-1642	19	YT-1709	368	YT-1916	190 387	YT-2007	121
YT-1310	71	YT-1409	27	YT-1470	35	YT-1575	22	YT-1643	19	YT-1711	368	YT-1918	190 386	YT-2008	121
YT-1311	71	YT-1410	27	YT-1471	35	YT-1576	22	YT-1644	19	YT-1713	368	YT-1919	190 387	YT-2016	121
YT-1312	71	YT-1411	27	YT-1472	35	YT-1577	22	YT-1647	19	YT-1714	368	YT-1920	191 388	YT-2018	121
YT-1313	71	YT-1412	27	YT-1473	35	YT-1578	22	YT-1649	19	YT-1715	368	YT-1922	190 386	YT-2026	121
YT-1314	71	YT-1413	27	YT-1474	35	YT-1586	22	YT-1650	19	YT-1719	369	YT-1923	190 386	YT-2028	121
YT-1315	71	YT-1414	27	YT-1475	35	YT-1588	79	YT-1651	10	YT-1720	369	YT-1924	191 388	YT-2029	122
YT-1316	71	YT-1415	27	YT-1476	35	YT-1589	79	YT-1652	10	YT-1721	369	YT-1925	191 256 388	YT-2030	122
YT-1317	71	YT-1416	27	YT-1478	35	YT-1590	79	YT-1653	10	YT-1751	342	YT-1930	192 389	YT-2031	122
YT-1318	71	YT-1417	27	YT-1480	35	YT-1591	79	YT-1654	10	YT-1752	342	YT-1933	147 189	YT-2036	121
YT-1319	71	YT-1418	27	YT-1481	35	YT-1592	79	YT-1655	10	YT-1753	342	YT-1939	192 257 389	YT-2037	121
YT-1320	71	YT-1419	27	YT-1501	113	YT-1593	79	YT-1656	10	YT-1754	342	YT-1940	121	YT-2039	128
YT-1322	71	YT-1420	27	YT-1502	113	YT-1594	79	YT-1657	10	YT-1756	342	YT-1941	121	YT-2046	128
YT-1323	71	YT-1421	27	YT-1503	113	YT-1596	79	YT-1658	10	YT-1757	313	YT-1942	121	YT-2047	128
YT-1324	71	YT-1422	27	YT-1505	113	YT-1598	79	YT-1659	10	YT-1762	343	YT-1943	121	YT-2048	128
YT-1326	71	YT-1423	27	YT-1507	113	YT-1599	79	YT-1660	10	YT-17625	343	YT-1944	121	YT-2050	128
YT-1328	71	YT-1424	27	YT-1508	113	YT-1600	93	YT-1661	10	YT-1763	183 365	YT-1945	121	YT-2051	128
YT-1330	71	YT-1425	28	YT-1511	113	YT-1601	17	YT-1662	10	YT-1764	183 365	YT-1946	121	YT-2052	128
YT-1334	72	YT-1426	28	YT-1512	113	YT-1602	17	YT-1663	10	YT-1765	183 365	YT-1947	121	YT-2055	128
YT-1335	72	YT-1427	28	YT-1513	113	YT-1603	17	YT-1664	10	YT-1766	183 365	YT-1948	121	YT-2056	128



YATO	page/strona	YATO	page/strona	YATO	page/strona	YATO	page/strona	YATO	page/strona	YATO	page/strona	YATO	page/strona	YATO	page/strona
YT-2057	128	YT-2162	133 383	YT-2233	210 228	YT-22930	144	YT-24301	366	YT-2571	106	YT-25920	97	YT-2601	101
YT-2058	128	YT-2163	133 383	YT-22338	210 228	YT-2294	144	YT-2449	131	YT-2575	96	YT-25921	97	YT-2602	101
YT-2060	128	YT-2165	23	YT-2234	210 228	YT-2295	144	YT-2450	131	YT-2576	96	YT-25922	97	YT-2603	101
YT-2061	128	YT-21650	23	YT-2235	210 228	YT-2296	140	YT-2451	131	YT-2577	96	YT-25923	97	YT-2604	101
YT-2063	128	YT-21651	23	YT-22353	209 227	YT-2297	141	YT-2452	131	YT-25802	103	YT-25924	97	YT-2606	101
YT-2064	128	YT-21652	23	YT-22354	209 227	YT-2298	141	YT-2453	131	YT-25803	103	YT-25925	97	YT-2607	101
YT-2066	122	YT-21653	23	YT-22355	209 227	YT-2299	141	YT-2459	131	YT-25804	103	YT-25926	97	YT-2608	101
YT-2067	122	YT-21654	23	YT-22360	232	YT-2300	140	YT-2460	131	YT-25805	103	YT-25927	97	YT-2609	101
YT-2069	134 226	YT-2166	23	YT-22361	232	YT-2301	141	YT-2461	132 383	YT-25806	103	YT-25928	97	YT-2610	101
YT-2070	134 226	YT-2167	23	YT-2240	142	YT-2302	141	YT-2463	132 383	YT-25807	103	YT-25929	97	YT-2612	101
YT-2071	23	YT-2168	23	YT-2242	142	YT-2305	142	YT-2466	132 384	YT-25808	103	YT-25930	97	YT-2613	101
YT-2072	23	YT-2170	23	YT-22422	142	YT-2307	141	YT-2468	132 384	YT-25809	103	YT-25931	97	YT-2614	101
YT-2073	23	YT-2171	23	YT-2243	142	YT-2313	145	YT-2469	132 384	YT-25810	103	YT-25932	97	YT-2615	101
YT-2074	23	YT-2172	23	YT-2244	142	YT-2316	145	YT-2473	132	YT-25811	103	YT-25933	97	YT-2618	101
YT-2075	23	YT-2173	23	YT-2245	140	YT-2319	144	YT-2476	132	YT-25831	103	YT-25934	97	YT-2619	101
YT-2080	124	YT-2180	229	YT-2246	140	YT-2340	282	YT-2482	134 225	YT-25832	103	YT-25940	97	YT-2620	92
YT-2081	124	YT-2182	229	YT-2247	141	YT-2341	282	YT-2483	134 225	YT-25833	103	YT-25941	97	YT-2621	92
YT-2082	124	YT-21840	229	YT-2249	141	YT-2346	282	YT-2484	134 225	YT-25834	103	YT-25942	97	YT-2622	92
YT-2083	124	YT-21842	229	YT-2250	140	YT-2357	282	YT-2485	134 225	YT-25835	103	YT-25943	97	YT-2623	92
YT-2084	124	YT-21843	229	YT-2251	141	YT-2370	282	YT-2488	134 225	YT-25836	103	YT-25950	97	YT-2624	92
YT-2085	124	YT-21844	229	YT-2254	143	YT-2371	282	YT-2489	134 225	YT-25837	103	YT-25951	97	YT-2625	92
YT-2086	124	YT-21845	229	YT-2255	140	YT-2372	282	YT-2490	134 225	YT-25838	103	YT-25952	97	YT-2626	92
YT-2090	134 226	YT-21846	229	YT-2256	140	YT-2373	283	YT-2491	134 225	YT-25839	103	YT-25953	97	YT-2627	92
YT-2091	134 226	YT-2201	134 225	YT-2260	146	YT-2374	283	YT-2492	134 225	YT-25840	103	YT-25954	97	YT-2628	92
YT-20911	134 226	YT-2203	134 225	YT-2261	146	YT-2375	283	YT-2493	134 225	YT-25841	103	YT-25955	97	YT-2629	92
YT-2101	126 139	YT-2204	134 225	YT-2262	146	YT-2376	283	YT-2494	134 225	YT-25842	103	YT-25956	97	YT-2630	92
YT-2102	126 139	YT-2205	134 225	YT-2263	146	YT-2380	284	YT-2510	319	YT-25843	103	YT-25957	97	YT-2631	92
YT-2103	126 139	YT-2206	134 225	YT-2266	143	YT-2381	284	YT-25105	319	YT-25844	103	YT-25958	97	YT-2633	101
YT-2104	126 139	YT-2210	226	YT-2267	143	YT-2382	284	YT-2511	318	YT-25845	103	YT-25959	97	YT-2634	101
YT-2105	126 139	YT-2211	226	YT-2268	145	YT-2383	284	YT-2512	318	YT-25846	103	YT-25960	97	YT-2635	101
YT-2107	126 139	YT-2212	226	YT-2270	145	YT-2384	284	YT-2513	318	YT-25852	103	YT-25961	97	YT-2636	101
YT-2109	126 139	YT-2213	226	YT-2271	143	YT-2385	284	YT-2514	318	YT-25853	103	YT-25965	98	YT-2637	101
YT-2110	126 139	YT-2214	226	YT-2272	144	YT-2390	285	YT-2515	318	YT-25854	103	YT-25966	99	YT-2638	101
YT-2112	126 139	YT-2215	226	YT-2273	144	YT-2391	285	YT-2516	318	YT-25855	103	YT-25967	99	YT-2639	101
YT-2130	129	YT-2216	226	YT-2274	145	YT-2392	285	YT-2517	318	YT-25856	103	YT-25968	100	YT-2640	101
YT-2136	129	YT-2217	226	YT-2275	145	YT-2393	285	YT-2518	318	YT-25857	103	YT-25971	99	YT-2641	101
YT-2137	129	YT-2218	226	YT-2276	145	YT-2394	285	YT-2519	318	YT-25861	103	YT-25972	106	YT-2642	101
YT-2138	129	YT-2222	134 225	YT-2277	143	YT-2395	285	YT-2520	318	YT-25862	103	YT-25980	98	YT-2643	101
YT-2139	129	YT-2223	134 225	YT-2278	145	YT-2396	285	YT-2521	318	YT-25863	103	YT-25981	99	YT-2644	101
YT-2140	130	YT-2224	134 225	YT-2279	146	YT-2397	285	YT-2522	318	YT-25900	97	YT-25982	100	YT-2645	101
YT-2141	130	YT-2225	134 225	YT-2280	146	YT-2398	285	YT-2523	318	YT-25901	97	YT-25985	98	YT-2647	101
YT-2142	130	YT-22260	134 226	YT-2283	141	YT-2399	285	YT-2535	355	YT-25902	97	YT-25986	98	YT-2648	101
YT-2143	130	YT-2228	209 227	YT-22860	143	YT-2401	285	YT-2536	355	YT-25903	97	YT-25987	98	YT-2649	101
YT-2144	130	YT-2229	209 227	YT-22861	143	YT-2402	285	YT-2537	355	YT-25904	97	YT-25988	98	YT-2650	101
YT-2145	130	YT-2230	209 227	YT-22862	143	YT-2403	285	YT-2538	350	YT-25905	97	YT-25989	98	YT-2653	101
YT-2146	130	YT-2231	209 227	YT-22870	193	YT-2404	285	YT-2539	321	YT-25906	97	YT-25990	98	YT-2654	101
YT-2147	130	YT-22312	209 227	YT-22871	193	YT-2405	285	YT-2540	321	YT-25907	97	YT-25991	98	YT-2655	101
YT-2151	131	YT-22313	210 228	YT-22872	193	YT-2406	285	YT-2541	321	YT-25908	97	YT-25992	98	YT-2656	101
YT-2152	131	YT-22314	210 228	YT-22873	193	YT-2407	285	YT-2542	322	YT-25909	97	YT-25993	98	YT-2657	101
YT-2153	131	YT-22315	210 228	YT-22874	193	YT-24091	285	YT-2543	322	YT-25910	97	YT-25994	98	YT-2658	101
YT-2155	131	YT-22316	210 228	YT-22875	193	YT-24092	285	YT-2544	355	YT-25911	97	YT-25995	98	YT-2661	101
YT-2156	131	YT-22317	210 228	YT-2290	144	YT-24093	285	YT-2545	320	YT-25912	97	YT-25996	98	YT-2663	101
YT-2160	133 383	YT-22318	210 228	YT-2292	144	YT-24094	285	YT-2546	355	YT-25913	97	YT-25997	98	YT-2665	101
YT-2161	133 383	YT-2232	210 228	YT-2293	144	YT-24095	285	YT-2547	355	YT-25914	97	YT-25998	98	YT-2667	101

YATO	page/strom	YATO	page/strom	YATO	page/strom	YATO	page/strom	YATO	page/strom	YATO	page/strom	YATO	page/strom	YATO	page/strom
YT-2668	102	YT-2748	101	YT-2817	104 138	YT-2917	224	YT-2979	181	YT-3200	194 458 460	YT-3277	177	YT-3372	179
YT-2669	102	YT-2750	101	YT-2818	104 138	YT-2918	224	YT-2980	182	YT-3201	194 458 460	YT-3278	177	YT-3373	179
YT-2670	102	YT-2752	101	YT-2819	104 138	YT-2919	224	YT-2981	182	YT-3202	194 458 460	YT-3279	177	YT-3374	179
YT-2675	92	YT-2753	101	YT-2820	104 138	YT-2920	224	YT-2982	182	YT-3203	194 458 460	YT-3280	177	YT-3376	179
YT-2676	92	YT-2754	101	YT-2821	104 138	YT-2921	224	YT-2983	182	YT-3204	194 458 460	YT-3281	177	YT-3377	179
YT-2677	92	YT-2756	101	YT-2822	104 138	YT-2926	181	YT-2984	182	YT-3221	195 458 460	YT-3282	177	YT-3380	180
YT-2678	92	YT-2757	101	YT-2823	104 138	YT-2927	181	YT-2985	182	YT-3222	195 458 460	YT-3283	177	YT-3381	180
YT-2679	92	YT-2760	92	YT-2824	104 138	YT-2930	181	YT-2986	182	YT-3223	195 458 460	YT-3284	177	YT-3400	196
YT-2682	92	YT-2761	92	YT-2825	104 138	YT-2931	181	YT-2987	182	YT-3224	195 458 460	YT-3285	177	YT-3401	196
YT-2683	92	YT-2762	92	YT-2826	104 138	YT-2932	181	YT-2988	182	YT-3230	195 458 460	YT-3286	177	YT-3402	196
YT-2686	92	YT-2763	92	YT-2827	104 138	YT-2933	181	YT-2989	182	YT-3231	195 458 460	YT-3287	177	YT-3403	196
YT-2687	92	YT-2764	92	YT-2828	104 138	YT-2934	181	YT-2990	182	YT-3232	195 458 460	YT-3288	177	YT-3404	196
YT-2688	92	YT-2765	92	YT-2830	148	YT-2935	181	YT-2991	182	YT-3233	195 458 460	YT-3289	177	YT-3405	196
YT-2689	92	YT-2766	92	YT-2840	93	YT-2937	181	YT-2992	182	YT-3234	195 458 460	YT-3290	177	YT-3407	196
YT-2690	92	YT-2767	92	YT-2842	93	YT-2939	181	YT-2993	182	YT-3236	176	YT-3291	177	YT-3408	196
YT-2691	92	YT-2768	92	YT-2843	93	YT-2940	181	YT-2994	182	YT-3237	176	YT-3292	177	YT-3409	196
YT-2692	92	YT-2769	92	YT-2844	93	YT-2941	181	YT-2995	182	YT-3238	176	YT-3293	177	YT-3410	196
YT-2693	92	YT-2770	92	YT-2845	93	YT-2942	181	YT-2996	182	YT-3239	176	YT-3294	177	YT-3411	196
YT-2694	92	YT-2771	92	YT-2846	93	YT-2943	181	YT-2997	182	YT-3240	176	YT-3295	177	YT-3412	196
YT-2699	93	YT-2772	92	YT-2847	93	YT-2944	181	YT-3001	273	YT-3241	176	YT-3296	177	YT-3413	196
YT-2700	93	YT-2773	92	YT-28480	330	YT-2945	181	YT-3002	273	YT-3242	176	YT-3297	177	YT-3414	196
YT-2701	93	YT-2774	92	YT-2861	148 266	YT-2946	181	YT-3003	273	YT-3243	176	YT-3298	177	YT-3415	196
YT-2702	93	YT-2775	92	YT-2862	148 266	YT-2947	181	YT-3004	273	YT-3244	176	YT-3299	177	YT-3416	196
YT-2703	93	YT-2776	92	YT-2863	148 266	YT-2948	181	YT-3005	273	YT-3245	176	YT-3300	177	YT-3417	196
YT-2704	93	YT-2777	92	YT-28631	148	YT-2949	181	YT-3022	273	YT-3246	176	YT-3303	179	YT-3421	196
YT-2705	93	YT-2778	92	YT-2864	148	YT-2950	181	YT-3023	273	YT-3247	176	YT-3304	179	YT-3430	197
YT-2706	93	YT-2779	92	YT-2865	365	YT-2951	181	YT-3024	273	YT-3248	176	YT-3306	179	YT-3431	197
YT-2708	93	YT-2780	106	YT-2866	365	YT-2952	181	YT-3025	273	YT-3249	176	YT-3308	179	YT-3432	197
YT-2709	93	YT-2781	95	YT-28950	178	YT-2953	181	YT-3026	273	YT-3250	176	YT-3311	179	YT-3433	197
YT-2710	93	YT-2782	94	YT-28951	178	YT-2954	181	YT-3071	258	YT-3251	176	YT-3313	179	YT-3434	197
YT-2711	93	YT-2783	94	YT-28952	178	YT-2955	181	YT-3072	258	YT-3252	176	YT-3315	179	YT-3435	197
YT-2712	93	YT-2784	94	YT-28953	178	YT-2956	181	YT-3073	258	YT-3253	176	YT-3317	179	YT-3440	197
YT-2715	92	YT-2785	95	YT-28954	178	YT-2957	181	YT-3074	258	YT-3254	176	YT-3318	179	YT-3441	197
YT-2716	92	YT-2786	95	YT-28955	178	YT-2958	181	YT-3076	258	YT-3255	176	YT-3321	179	YT-3442	197
YT-2717	92	YT-2787	94	YT-28956	178	YT-2959	181	YT-3077	258	YT-3256	176	YT-3322	179	YT-3443	197
YT-2718	92	YT-2788	94	YT-28957	178	YT-2960	182	YT-3078	258	YT-3257	176	YT-3323	179	YT-3444	197
YT-2719	92	YT-2789	95	YT-28958	178	YT-2961	182	YT-3079	258	YT-3258	176	YT-3324	179	YT-3445	197
YT-2721	92	YT-2790	96	YT-28959	178	YT-2962	182	YT-3081	258	YT-3259	176	YT-3327	179	YT-3460	195
YT-2722	92	YT-2791	96	YT-28960	178	YT-2963	182	YT-3082	258	YT-3261	177	YT-3329	179	YT-3461	195
YT-2723	92	YT-2795	96	YT-28961	178	YT-2964	182	YT-3083	258	YT-3262	177	YT-3330	179	YT-3462	195
YT-2725	92	YT-2797	105	YT-28962	178	YT-2965	182	YT-3084	258	YT-3263	177	YT-3332	179	YT-34680	198
YT-2727	92	YT-2798	105	YT-28963	178	YT-2966	182	YT-3101	194	YT-3264	177	YT-3333	179	YT-34681	198
YT-2728	92	YT-2799	106	YT-28964	178	YT-2967	182	YT-3102	194	YT-3265	177	YT-3334	179	YT-34682	198
YT-2729	92	YT-2800	107	YT-28965	178	YT-2968	182	YT-3103	194	YT-3266	177	YT-3336	179	YT-34683	198
YT-2730	92	YT-2801	107	YT-28966	178	YT-2969	182	YT-3106	194	YT-3267	177	YT-3338	179	YT-34684	199
YT-2731	92	YT-2802	107	YT-28967	178	YT-2970	182	YT-3107	194	YT-3268	177	YT-3343	179	YT-34685	199
YT-2732	92	YT-2804	105	YT-2900	224	YT-2971	182	YT-3108	194	YT-3269	177	YT-3345	179	YT-34686	199
YT-2733	92	YT-2806	107	YT-29001	224	YT-2972	182	YT-3130	194	YT-3270	177	YT-3346	179	YT-34687	199
YT-2741	101	YT-2808	105	YT-2910	224	YT-2973	182	YT-3133	194	YT-3271	177	YT-3349	179	YT-34688	200
YT-2742	101	YT-2810	108	YT-2911	224	YT-2974	182	YT-3134	194	YT-3272	177	YT-3350	179	YT-34689	200
YT-2743	101	YT-2811	108	YT-2912	224	YT-2975	181	YT-3150	194	YT-3273	177	YT-3351	179	YT-34690	200
YT-2744	101	YT-2812	108	YT-2913	224	YT-2976	182	YT-3160	195	YT-3274	177	YT-3353	179	YT-34691	200
YT-2745	101	YT-2815	104 138	YT-2914	224	YT-2977	182	YT-3161	195	YT-3275	177	YT-3370	179	YT-3590	208
YT-2746	101	YT-2816	104 138	YT-2916	224	YT-2978	181	YT-3163	195	YT-3276	177	YT-3371	179	YT-3591	208

YATO	page/strona	YATO	page/strona	YATO	page/strona	YATO	page/strona	YATO	page/strona	YATO	page/strona	YATO	page/strona	YATO	page/strona
YT-3600	236	YT-3810	31	YT-38781	43	YT-4140	174	YT-4220	174	YT-4444	173	YT-4570	157	YT-4705	160
YT-36011	236	YT-3811	31	YT-38782	61	YT-4160	174	YT-4221	174	YT-4445	173	YT-4571	157	YT-4710	160
YT-36012	236	YT-3812	31	YT-3879	64	YT-4161	175	YT-4222	174	YT-4446	173	YT-4573	157	YT-4711	161
YT-3609	236	YT-3813	31	YT-38791	45	YT-4162	175	YT-4223	174	YT-4447	173	YT-4590	159 381	YT-4712	161
YT-36092	236	YT-3814	31	YT-3880	66	YT-4163	175	YT-4224	174	YT-4448	173	YT-4594	158	YT-47121	161
YT-36095	237	YT-3820	31	YT-38801	47	YT-4164	175	YT-4225	174	YT-4449	173	YT-4600	158	YT-4713	162
YT-3610	237	YT-3821	31	YT-3881	68	YT-4165	175	YT-4226	174	YT-4450	173	YT-4601	158	YT-4714	162
YT-36119	238	YT-3822	31	YT-38811	48	YT-4166	175	YT-4227	174	YT-4451	173	YT-4602	158	YT-47141	161
YT-3612	237	YT-3823	31	YT-3882	57	YT-4167	175	YT-4228	174	YT-4452	173	YT-4603	158	YT-47142	161
YT-36129	238	YT-3824	31	YT-38821	42	YT-4168	175	YT-4229	174	YT-4453	173	YT-4604	158	YT-47143	161
YT-3613	237	YT-3825	31	YT-3883	66	YT-4169	175	YT-4230	174	YT-4454	173	YT-4605	158	YT-47144	161
YT-3617	238 286	YT-3826	31	YT-38831	46	YT-4170	175	YT-4350	177	YT-4455	173	YT-4620	158 382	YT-47145	161
YT-3618	238 286	YT-3827	31	YT-3884	69	YT-4171	175	YT-4351	177	YT-4456	173	YT-4622	158 382	YT-47146	161
YT-3635	238	YT-3828	31	YT-38841	49	YT-4172	175	YT-4352	177	YT-4457	173	YT-4623	158 382	YT-47147	161
YT-3636	238	YT-3829	31	YT-3886	57	YT-4173	175	YT-4353	177	YT-4458	173	YT-4624	158 382	YT-47148	161
YT-36700	230 244 406	YT-3830	31	YT-38861	42	YT-4174	175	YT-4354	177	YT-4460	173	YT-4625	158 382	YT-47149	161
YT-36704	231 245 407	YT-3831	31	YT-3887	67	YT-4175	175	YT-4355	177	YT-4461	173	YT-4626	158 382	YT-47150	161
YT-36706	230 244 406	YT-3832	31	YT-38872	47	YT-4176	175	YT-4356	177	YT-4462	173	YT-4630	158 382	YT-47151	161
YT-36709	231 245 407	YT-3833	31	YT-3888	67	YT-4177	175	YT-4357	177	YT-4491	156	YT-4631	158 382	YT-47152	161
YT-3701	250	YT-3839	32	YT-38881	48	YT-4178	175	YT-4358	177	YT-4492	156	YT-4632	158 382	YT-4720	178
YT-3702	250	YT-3840	32	YT-3889	65	YT-4179	175	YT-4359	177	YT-4493	156	YT-4633	158 382	YT-4721	178
YT-3703	251	YT-3841	32	YT-38891	45	YT-4180	175	YT-4361	175	YT-4494	156	YT-4634	158 382	YT-4722	178
YT-3704	251	YT-3842	31	YT-3890	65	YT-4181	175	YT-4362	175	YT-4495	156	YT-4635	158 382	YT-4723	178
YT-3705	251	YT-3843	31	YT-38901	46	YT-4182	175	YT-4363	175	YT-4496	156	YT-4636	158 382	YT-4730	163
YT-3706	251	YT-3844	31	YT-3891	62	YT-4183	175	YT-4364	175	YT-4497	156	YT-4637	158 382	YT-4750	203
YT-3707	251	YT-3845	31	YT-3893	68	YT-4184	175	YT-4367	175	YT-4498	156	YT-4638	158 382	YT-4751	203
YT-3708	251	YT-3847	31	YT-38931	49	YT-4185	175	YT-4369	175	YT-4499	156	YT-4639	158 382	YT-4752	203
YT-3712	251	YT-3848	31	YT-3894	69	YT-4186	175	YT-4370	175	YT-4500	156	YT-4640	158 382	YT-4755	203
YT-3713	251	YT-3849	31	YT-38941	50	YT-4187	175	YT-4373	175	YT-4501	156	YT-4641	158 382	YT-4757	203
YT-3714	251	YT-3850	32	YT-3895	309	YT-4188	175	YT-4375	175	YT-4502	156	YT-4642	158 382	YT-4758	203
YT-37160	252	YT-3851	32 349	YT-38950	310	YT-4189	175	YT-4376	175	YT-4503	156	YT-4643	158 382	YT-4759	203
YT-37161	252	YT-3853	32	YT-38951	310	YT-4190	175	YT-4379	175	YT-4504	156	YT-4644	158 382	YT-4761	203
YT-37162	252	YT-3854	32	YT-4020	174	YT-4191	175	YT-4380	175	YT-4505	156	YT-46800	163	YT-4763	203
YT-37163	252	YT-3855	55	YT-4025	174	YT-4192	175	YT-4383	175	YT-4506	156	YT-46801	163	YT-4764	203
YT-37164	252	YT-3856	55	YT-4030	174	YT-4200	174	YT-4385	175	YT-4507	156	YT-46802	163	YT-4766	203
YT-37170	252	YT-38561	41	YT-4032	174	YT-4201	174	YT-4390	175	YT-4508	156	YT-46803	163	YT-4767	203
YT-3725	178	YT-3857	56	YT-4035	174	YT-4202	174	YT-4400	179	YT-4509	156	YT-46804	163	YT-4768	203
YT-3726	178	YT-38631	55	YT-4040	174	YT-4203	174	YT-4401	179	YT-4510	156	YT-46810	163	YT-4769	203
YT-3727	178	YT-38641	55	YT-4042	174	YT-4204	174	YT-4402	179	YT-4515	159 381	YT-46811	163	YT-4830	13
YT-3728	178	YT-3865	70	YT-4045	174	YT-4205	174	YT-4403	179	YT-4516	159 381	YT-46812	163	YT-4831	13
YT-3730	250	YT-3867	58	YT-4048	174	YT-4206	174	YT-4430	173	YT-4518	159 381	YT-46813	163	YT-4832	13
YT-3735	208 253	YT-38671	43	YT-4050	174	YT-4207	174	YT-4431	173	YT-4519	159 381	YT-46814	163	YT-4833	13
YT-3736	208 253	YT-3868	57	YT-4052	174	YT-4208	174	YT-4432	173	YT-4520	159 381	YT-46820	163	YT-4834	13
YT-3740	208	YT-38681	42	YT-4055	174	YT-4209	174	YT-4433	173	YT-4521	159 381	YT-46821	163	YT-4835	13
YT-37690	78	YT-38682	57	YT-4060	174	YT-4210	174	YT-4434	173	YT-4522	159 381	YT-46822	163	YT-4836	13
YT-3801	31	YT-3869	59	YT-4065	174	YT-4211	174	YT-4435	173	YT-4550	156	YT-46823	163	YT-4837	13
YT-3802	31	YT-3870	59	YT-4070	174	YT-4212	174	YT-4436	173	YT-4551	156	YT-4690	162	YT-4860	16
YT-3803	31	YT-3871	60	YT-4075	174	YT-4213	174	YT-4437	173	YT-4552	156	YT-4691	162	YT-4861	16
YT-3804	31	YT-3872	59	YT-4080	174	YT-4214	174	YT-4438	173	YT-4553	156	YT-4692	162	YT-4862	16
YT-3805	31	YT-3873	59	YT-4085	174	YT-4215	174	YT-4439	173	YT-4560	157	YT-4693	162	YT-4863	16
YT-3806	31	YT-3874	60	YT-4090	174	YT-4216	174	YT-4440	173	YT-4561	157	YT-4694	162	YT-4864	16
YT-3807	31	YT-3876	60	YT-4100	174	YT-4217	174	YT-4441	173	YT-4562	157	YT-4695	162	YT-4865	16
YT-3808	31	YT-3877	61	YT-4110	174	YT-4218	174	YT-4442	173	YT-4563	157	YT-4700	160	YT-4870	8
YT-3809	31	YT-3878	62	YT-4120	174	YT-4219	174	YT-4443	173	YT-4564	157	YT-4701	160	YT-4871	8

YATO	page/strona	YATO	page/strona	YATO	page/strona	YATO	page/strona	YATO	page/strona	YATO	page/strona	YATO	page/strona	YATO	page/strona
YT-4872	8	YT-4964	20	YT-5247	255	YT-55361	306	YT-5774	114	YT-5927	187	YT-6063	187	YT-6135	188
YT-4873	8	YT-4965	20	YT-5250	253	YT-5537	303	YT-5775	114	YT-5930	188	YT-6065	187	YT-6136	187
YT-4874	8	YT-4966	20	YT-5251	253	YT-55371	306	YT-5777	114	YT-5932	188	YT-6066	187	YT-6137	187
YT-4875	8	YT-5000	8	YT-5252	253	YT-5538	303	YT-5778	114	YT-5933	188	YT-6067	187	YT-6138	188
YT-4876	8	YT-5001	8	YT-5253	253	YT-55381	306	YT-5779	114	YT-5934	188	YT-6068	187	YT-6140	213
YT-4877	8	YT-5002	8	YT-5254	253	YT-5539	304	YT-5780	114	YT-5935	188	YT-6070	187	YT-6141	213
YT-4878	8	YT-5003	8	YT-5255	253	YT-55391	306	YT-5781	114	YT-5940	187	YT-6071	187	YT-6142	213
YT-4879	8	YT-5005	8	YT-5260	253	YT-5540	304	YT-5785	114	YT-5942	187	YT-6072	187	YT-6143	213
YT-4880	8	YT-5006	8	YT-5261	253	YT-55401	306	YT-5786	114	YT-5944	187	YT-6075	187	YT-6144	214
YT-4881	8	YT-5008	8	YT-5262	253	YT-5541	303	YT-5791	114	YT-5945	187	YT-6076	187	YT-6145	214
YT-4882	8	YT-5009	8	YT-5302	255	YT-55411	306	YT-5792	114	YT-5946	188	YT-6077	187	YT-6146	214
YT-4883	8	YT-5010	8	YT-5304	255	YT-5542	303	YT-5793	114	YT-5947	188	YT-6078	187	YT-6147	213
YT-4884	8	YT-5012	8	YT-5400	257	YT-55421	306	YT-5794	114	YT-5948	188	YT-6080	187	YT-6148	213
YT-4885	8	YT-5014	8	YT-5402	257	YT-5543	300	YT-5795	114	YT-5949	188	YT-6081	187	YT-6149	213
YT-4901	9	YT-5015	8	YT-5404	257	YT-55443	301	YT-5796	114	YT-5953	185	YT-6082	187	YT-6150	213
YT-4902	9	YT-5016	8	YT-5405	257	YT-55444	302	YT-5797	114	YT-5954	185	YT-6083	187	YT-6151	214
YT-4903	9	YT-5017	8	YT-5410	257	YT-55451	304	YT-5798	114	YT-5955	185	YT-6085	187	YT-6152	213
YT-4904	9	YT-5018	8	YT-5415	257 389	YT-55453	304	YT-5802	114	YT-5956	185	YT-6086	187	YT-6153	213
YT-4905	9	YT-5019	8	YT-5416	257 389	YT-55455	302	YT-5803	114	YT-5965	185	YT-6091	187	YT-6154	213
YT-4906	9	YT-5020	8	YT-5417	257 389	YT-55456	301	YT-5804	114	YT-5966	185	YT-6093	187	YT-6155	213
YT-4907	9	YT-5021	8	YT-5483	262	YT-55457	304	YT-5805	114	YT-5973	186	YT-6095	187	YT-6156	213
YT-4908	9	YT-5022	8	YT-5490	262	YT-55458	303	YT-5806	114	YT-5974	186	YT-6097	187	YT-6160	213
YT-4909	9	YT-5023	8	YT-5491	262	YT-55462	303	YT-5807	114	YT-5975	186	YT-6099	187	YT-6161	213
YT-4910	9	YT-5024	8	YT-5492	262	YT-55463	301	YT-5808	114	YT-5991	186	YT-6101	187	YT-6162	213
YT-4911	9	YT-5025	8	YT-5493	262	YT-55464	302	YT-5812	114	YT-5992	186	YT-6102	187	YT-6163	213
YT-4912	9	YT-5030	14	YT-5494	262	YT-55465	305	YT-5813	114	YT-5994	186	YT-6103	187	YT-6164	213
YT-4915	21	YT-5031	14	YT-5496	262	YT-55466	305	YT-5814	114	YT-6002	185	YT-6104	187	YT-6165	213
YT-4916	21	YT-5033	14	YT-5497	262	YT-55469	302	YT-5820	115	YT-6003	185	YT-6105	187	YT-6180	212
YT-4917	21	YT-5038	14	YT-5499	262	YT-55471	305	YT-5821	115	YT-6004	185	YT-6106	187	YT-6181	212
YT-4918	21	YT-5130	133 384	YT-5500	262	YT-55472	301	YT-5822	115	YT-6005	185	YT-6107	187	YT-6182	212
YT-4919	21	YT-5131	133 384	YT-5501	262	YT-55473	301	YT-5823	115	YT-6012	185	YT-6108	187	YT-6183	212
YT-4920	21	YT-5140	133 384	YT-5502	262	YT-55474	304	YT-5832	115	YT-6013	185	YT-6110	187	YT-6184	212
YT-4921	21	YT-5141	133 384	YT-5503	262	YT-55476	305	YT-5833	115	YT-6014	185	YT-6111	187	YT-6185	212
YT-4922	21	YT-5142	133 384	YT-5504	262	YT-55477	305	YT-5835	115	YT-6015	185	YT-6112	187	YT-6186	212
YT-4923	21	YT-5200	254	YT-5505	262	YT-55478	305	YT-5837	115	YT-6016	185	YT-6113	187	YT-6187	212
YT-4924	21	YT-5202	254	YT-5506	262	YT-55479	306	YT-5838	115	YT-6017	185	YT-6114	188	YT-6188	212
YT-4925	21	YT-5203	254	YT-5507	262	YT-5555	369	YT-5890	373	YT-6022	185	YT-6115	188	YT-6189	212
YT-4926	21	YT-5204	254	YT-5508	262	YT-55560	374	YT-5892	373	YT-6023	185	YT-6116	188	YT-6190	212
YT-4927	21	YT-5207	254	YT-55290	295	YT-55561	374	YT-5893	373	YT-6024	185	YT-6117	188	YT-6191	212
YT-4928	21	YT-5209	254	YT-55291	291	YT-55562	374	YT-5894	373	YT-6025	185	YT-6119	188	YT-6192	212
YT-4937	21	YT-5210	254	YT-55292	294	YT-55565	375	YT-5901	259 373 405	YT-6030	186	YT-6120	188	YT-6193	212
YT-4945	21	YT-5212	254	YT-55293	292	YT-55568	375	YT-5902	259 373 405	YT-6032	186	YT-6121	188	YT-6194	212
YT-4950	20	YT-5214	254	YT-5530	293	YT-55580	375	YT-5904	259 373 405	YT-6045	186	YT-6122	187	YT-6219	215
YT-4951	20	YT-5216	254	YT-5531	300	YT-55581	375	YT-5905	259 373 405	YT-6046	186	YT-6123	188	YT-6220	215
YT-4952	20	YT-5218	254	YT-55311	306	YT-55582	375	YT-5911	373	YT-6050	187	YT-6124	188	YT-6221	215
YT-4953	20	YT-5226	254	YT-5532	300	YT-5702	211	YT-5913	373	YT-6052	187	YT-6125	188	YT-6222	215
YT-4954	20	YT-5228	254	YT-55321	306	YT-5703	211	YT-5914	373	YT-6053	187	YT-6126	188	YT-6223	212
YT-4955	20	YT-5230	254	YT-5533	300	YT-5704	211	YT-5920	187	YT-6055	187	YT-6128	188	YT-6224	212
YT-4956	20	YT-5234	255	YT-55331	306	YT-5710	208	YT-5921	187	YT-6056	187	YT-6129	188	YT-6225	212
YT-4957	20	YT-5237	255	YT-5534	301	YT-5761	114	YT-5922	187	YT-6057	187	YT-6130	188	YT-6226	212
YT-4960	20	YT-5240	255	YT-55341	306	YT-5770	114	YT-5923	187	YT-6058	187	YT-6131	188	YT-6227	212
YT-4961	20	YT-5242	255	YT-5535	302	YT-5771	114	YT-5924	187	YT-6060	187	YT-6132	188	YT-6228	212
YT-4962	20	YT-5243	255	YT-55351	306	YT-5772	114	YT-5925	187	YT-6061	187	YT-6133	188	YT-6229	212
YT-4963	20	YT-5245	255	YT-5536	302	YT-5773	114	YT-5926	187	YT-6062	187	YT-6134	188	YT-6230	212

YATO	page/strona	YATO	page/strona	YATO	page/strona	YATO	page/strona	YATO	page/strona	YATO	page/strona	YATO	page/strona
YT-6231	212	YT-63701	202 232	YT-6454	166	YT-6925	262	YT-7054	239	YT-7201	270	YT-73761	420
YT-6232	212	YT-63702	202 232	YT-6501	167	YT-6926	262	YT-7055	239	YT-7220	273	YT-7377	421
YT-6233	212	YT-63703	202 232	YT-6502	167	YT-6927	262	YT-7070	270	YT-7221	273	YT-7380	421
YT-6234	212	YT-63704	202 232	YT-6503	167	YT-69280	263	YT-7071	270	YT-7222	273	YT-73801	421
YT-6235	212	YT-63705	202 232	YT-6504	167	YT-69281	263	YT-7080	270	YT-7223	273	YT-7381	421
YT-6236	212	YT-6401	166	YT-65048	167	YT-69285	263	YT-7081	270	YT-72300	271	YT-7382	421
YT-6237	212	YT-6402	166	YT-65049	167	YT-69286	263	YT-7082	270	YT-72301	271	YT-7383	421
YT-6238	212	YT-6403	166	YT-6505	167	YT-69287	263	YT-7083	270	YT-72302	271	YT-73830	421
YT-6239	212	YT-6404	166	YT-6506	167	YT-6966	412	YT-7084	270	YT-72303	271	YT-73921	380
YT-6241	160	YT-6405	166	YT-6510	167 232	YT-6980	412	YT-7103	268	YT-72305	271	YT-7400	416
YT-6242	160	YT-6406	166	YT-6511	167 232	YT-6981	412	YT-7105	268	YT-7290	359	YT-7409	416
YT-6243	160	YT-6407	166	YT-6512	167 232	YT-6982	412	YT-7110	268	YT-7291	359	YT-7410	416
YT-6244	160	YT-6408	166	YT-6513	167 232	YT-6983	412	YT-7111	268	YT-7292	359	YT-7413	416
YT-6245	160	YT-6409	166	YT-6581	123	YT-6984	412	YT-7112	268	YT-7300	345	YT-7414	416
YT-6246	160	YT-6410	166	YT-6582	123	YT-6985	412	YT-71130	268	YT-7301	345	YT-7416	416
YT-6247	160	YT-6412	166	YT-6583	123	YT-6986	412	YT-71131	268	YT-7302	345	YT-7417	416
YT-6248	160	YT-6413	166	YT-6586	123	YT-6987	412	YT-71133	268	YT-73030	344	YT-7419	417
YT-6249	160	YT-6414	166	YT-6587	123	YT-6989	412	YT-71135	268	YT-7306	345	YT-7420	417
YT-6251	160	YT-6415	166	YT-6600	122	YT-69900	413	YT-71136	268	YT-7307	344	YT-7430	417
YT-6253	160	YT-6416	166	YT-6601	122	YT-69901	413	YT-71138	268	YT-73080	149 267	YT-7433	417
YT-6256	160	YT-6417	166	YT-6602	122	YT-69902	413	YT-71141	268	YT-73082	149 267	YT-7435	417
YT-6258	160	YT-6420	166	YT-6610	122	YT-69903	413	YT-71143	268	YT-73084	149 267	YT-7446	417
YT-6260	160	YT-6421	166	YT-6611	122	YT-69905	413	YT-71145	268	YT-73086	149 267	YT-7450	424
YT-6280	160	YT-6422	166	YT-6612	122	YT-69906	413	YT-71146	268	YT-73087	149 267	YT-7451	424
YT-6281	160	YT-6423	166	YT-6620	125	YT-69907	413	YT-7116	268	YT-73088	149 267	YT-74510	424
YT-6330	201	YT-6424	166	YT-6622	125	YT-69908	413	YT-7117	268	YT-73091	149 267	YT-7452	424
YT-6331	201	YT-64270	166	YT-6624	125	YT-69910	413	YT-7118	268	YT-7310	347	YT-7453	424
YT-6332	201	YT-64271	166	YT-6625	125	YT-69911	413	YT-71181	269	YT-7311	347	YT-7454	424
YT-6333	201	YT-64272	166	YT-6626	125	YT-69912	413	YT-71182	269	YT-7312	347	YT-7455	424
YT-6334	201	YT-64280	166	YT-6700	230 244 406	YT-69913	413	YT-71184	269	YT-73124	272	YT-7456	424
YT-6335	201	YT-64281	166	YT-6705	230 244 406	YT-69914	413	YT-71185	269	YT-73125	272	YT-7458	425
YT-6336	201	YT-64282	166	YT-6706	231 245 407	YT-69920	413	YT-71186	269	YT-73130	272	YT-7459	425
YT-6337	201	YT-64283	166	YT-6740	242	YT-69921	413	YT-71187	269	YT-7320	334	YT-7460	422
YT-6338	201	YT-64284	166	YT-6741	242	YT-69922	413	YT-71188	269	YT-73310	364 422	YT-7461	422
YT-6339	201	YT-64290	166	YT-6742	242	YT-69923	413	YT-71189	269	YT-7349	366	YT-7462	425
YT-6340	201	YT-64291	166	YT-6743	242	YT-69924	413	YT-7126	268	YT-7350	366	YT-74621	425
YT-6341	201	YT-64292	166	YT-6745	242	YT-7000	239	YT-7127	268	YT-7352	366	YT-7463	425
YT-6342	202	YT-64293	166	YT-6750	243	YT-7001	239	YT-7128	268	YT-7360	420	YT-7464	422
YT-6343	202	YT-64294	166	YT-6751	243	YT-7003	239	YT-7129	268	YT-7361	420	YT-7465	422
YT-6344	202	YT-64295	166	YT-6752	243	YT-7004	239	YT-7130	268	YT-7362	420	YT-7467	422
YT-6345	202	YT-6440	166	YT-6753	243	YT-7005	239	YT-7131	268	YT-7363	420	YT-7469	422
YT-6346	202	YT-6441	166	YT-6754	243	YT-7007	239	YT-71551	269	YT-73631	420	YT-7470	421
YT-6347	202	YT-6442	166	YT-6755	243	YT-7011	239	YT-71552	269	YT-7364	420	YT-7471	422
YT-6348	202	YT-6443	166	YT-6756	243	YT-7022	239	YT-71555	269	YT-73641	420	YT-7472	421
YT-6349	202	YT-6444	166	YT-6757	243	YT-7023	239	YT-71556	269	YT-7365	420	YT-7473	421
YT-6350	202	YT-6445	166	YT-6801	184	YT-7024	239	YT-71560	269	YT-7366	420	YT-7474	421
YT-6351	202	YT-6446	166	YT-6803	184	YT-7025	239	YT-71561	269	YT-7367	420	YT-7480	422
YT-6353	201	YT-6447	166	YT-6854	365	YT-7026	239	YT-71562	269	YT-7368	420	YT-7481	422
YT-6354	201	YT-6448	166	YT-6855	365	YT-7032	239	YT-71565	269	YT-7369	420	YT-7485	423
YT-6355	201	YT-6449	166	YT-6862	365	YT-7033	239	YT-71566	269	YT-7371	420	YT-7486	423
YT-6356	201	YT-6450	166	YT-6863	365	YT-7034	239	YT-71567	269	YT-7374	420	YT-7488	423
YT-6358	201	YT-6451	166	YT-6903	135 151 361	YT-7051	239	YT-7200	270	YT-73744	420	YT-7492	423
YT-6359	201	YT-6452	166	YT-6907	135 151 361	YT-7052	239	YT-72003	270	YT-7376	420	YT-74947	423
YT-6360	201	YT-6453	166	YT-6916	135 151 361	YT-7053	239	YT-72004	270	YT-73760	420	YT-74951	423

YATO	page/strona	YATO	page/strona	YATO	page/strona	YATO	page/strona	YATO	page/strona	YATO	page/strona	YATO	page/strona	YATO	page/strona
YT-7670	73	YT-7805	110	YT-7849	110	YT-80356	428	YT-80572	426	YT-80841	427	YT-81777	152	YT-8272	151 246
YT-7671	73	YT-7806	110	YT-7851	110	YT-80357	428	YT-80573	426	YT-80842	427	YT-81790	434	YT-8273	151 246
YT-7672	73	YT-7807	110	YT-7852	110	YT-80358	428	YT-80574	426	YT-80843	427	YT-81791	434	YT-82742	151 246
YT-7673	73	YT-7808	110	YT-7870	110	YT-80359	428	YT-80575	426	YT-80844	427	YT-81792	434	YT-82743	151 246
YT-7674	73	YT-7809	110	YT-7880	110	YT-80360	428	YT-80576	426	YT-80845	427	YT-81793	434	YT-82744	151 246
YT-7675	73	YT-7810	110	YT-7881	110	YT-80361	428	YT-80577	426	YT-80846	427	YT-81794	434	YT-8300	370
YT-7676	73	YT-7811	110	YT-7882	110	YT-80362	428	YT-80578	426	YT-80847	427	YT-81795	434	YT-8301	370
YT-7677	73	YT-7812	110	YT-7883	110	YT-80363	428	YT-80579	426	YT-80848	427	YT-81800	433	YT-83016	370
YT-7678	73	YT-7813	110	YT-7884	110	YT-80364	428	YT-80580	426	YT-80849	427	YT-81801	433	YT-8302	370
YT-7686	73	YT-78130	109	YT-7886	110	YT-80365	428	YT-80583	426	YT-80852	427	YT-81802	433	YT-8303	370
YT-7713	73	YT-78131	109	YT-7887	110	YT-80366	428	YT-80584	426	YT-80853	427	YT-81803	433	YT-8304	371
YT-7714	73	YT-78132	109	YT-7890	110	YT-80367	428	YT-80585	426	YT-80854	427	YT-81804	433	YT-8305	371
YT-7715	73	YT-78133	109	YT-7897	110	YT-80368	428	YT-80586	426	YT-80855	427	YT-81805	433	YT-83051	371
YT-7716	73	YT-78134	109	YT-7898	110	YT-80369	428	YT-80587	426	YT-80856	427	YT-81806	433	YT-83052	371
YT-7717	73	YT-78135	109	YT-7899	110	YT-80380	428	YT-80588	426	YT-80857	427	YT-81851	432	YT-83060	371
YT-7718	73	YT-78136	109	YT-7901	110	YT-80381	428	YT-80589	426	YT-80858	427	YT-81852	432	YT-83061	371
YT-7719	73	YT-7814	110	YT-7906	110	YT-80382	428	YT-80590	426	YT-80859	427	YT-81853	432	YT-83062	371
YT-7720	73	YT-78141	109	YT-7909	110	YT-80383	428	YT-80591	426	YT-80860	427	YT-81861	432	YT-8310	266 372
YT-7721	73	YT-78142	109	YT-7910	110	YT-80384	428	YT-80733	427	YT-8100	260 438	YT-81862	432	YT-83101	266 372
YT-7722	73	YT-78143	109	YT-7911	110	YT-80390	428	YT-80734	427	YT-8101	260 438	YT-81871	432	YT-8311	266 372
YT-7723	73	YT-78144	109	YT-7912	110	YT-80391	428	YT-80735	427	YT-8102	260 438	YT-82030	393	YT-83150	372
YT-7724	73	YT-78145	109	YT-7916	110	YT-80392	428	YT-80736	427	YT-81021	260 438	YT-82035	393	YT-83151	372
YT-7725	73	YT-78146	109	YT-7929	110	YT-80393	428	YT-80737	427	YT-81022	260 438	YT-82040	393	YT-83152	372
YT-7726	73	YT-78147	109	YT-7930	110	YT-80394	428	YT-80738	427	YT-81023	260 438	YT-82050	394	YT-83153	372
YT-7727	73	YT-7815	110	YT-7931	110	YT-80460	426	YT-80739	427	YT-81024	260 438	YT-82051	394	YT-83160	217
YT-7728	73	YT-78150	109	YT-7932	110	YT-80461	426	YT-80740	427	YT-81052	261 439	YT-82070	394	YT-83161	217
YT-7729	73	YT-78151	109	YT-7933	110	YT-80462	426	YT-80741	427	YT-81053	261 439	YT-82090	392	YT-83162	217
YT-7730	73	YT-78152	109	YT-7936	110	YT-80463	426	YT-80761	427	YT-81054	261 439	YT-82095	392	YT-83163	217
YT-7731	73	YT-78153	109	YT-7950	110	YT-80464	426	YT-80762	427	YT-8106	261 439	YT-82102	392	YT-83164	217
YT-7732	73	YT-78154	109	YT-7980	110	YT-80465	426	YT-80763	427	YT-8107	261 439	YT-82120	395	YT-83165	217
YT-7733	73	YT-78155	109	YT-8001	163 458	YT-80466	426	YT-80764	427	YT-8108	261 439	YT-82125	395	YT-83166	217
YT-7734	73	YT-78156	109	YT-8002	163 458	YT-80467	426	YT-80765	427	YT-8110	260 438	YT-82127	395	YT-83167	217
YT-7735	73	YT-7816	110	YT-8003	163 458	YT-80468	426	YT-80766	427	YT-8111	260 438	YT-82130	395	YT-83168	217
YT-7736	73	YT-78160	109	YT-8004	163 458	YT-80469	426	YT-80767	427	YT-8112	260 438	YT-82140	397	YT-83169	217
YT-7737	73	YT-78161	109	YT-8005	163 458	YT-80470	426	YT-80768	427	YT-8115	260 438	YT-82150	397	YT-83180	218
YT-7738	73	YT-78162	109	YT-8006	163 458	YT-80471	426	YT-80769	427	YT-8116	260 438	YT-82153	397	YT-83181	218
YT-7739	74	YT-78163	109	YT-8011	163 458	YT-80521	426	YT-80783	427	YT-81162	260 438	YT-82170	398	YT-83182	218
YT-7740	74	YT-78164	109	YT-8012	163 458	YT-80522	426	YT-80784	427	YT-8120	261 439	YT-82171	398	YT-83183	218
YT-7741	74	YT-78165	109	YT-8020	429	YT-80523	426	YT-80785	427	YT-8152	152	YT-82190	258 401	YT-83184	218
YT-7742	74	YT-78166	109	YT-8021	429	YT-80524	426	YT-80786	427	YT-8156	152	YT-82220	399	YT-83185	218
YT-7743	74	YT-78167	109	YT-8022	429	YT-80525	426	YT-80787	427	YT-8159	152	YT-82250	231 401	YT-83186	218
YT-7744	74	YT-7817	110	YT-8023	429	YT-80526	426	YT-80788	427	YT-81591	152	YT-82270	396	YT-83187	218
YT-7745	74	YT-7818	110	YT-8024	429	YT-80527	426	YT-80789	427	YT-81592	152	YT-82271	396	YT-83188	218
YT-7746	74	YT-78190	109	YT-8025	429	YT-80528	426	YT-80790	427	YT-81593	152	YT-82272	396	YT-83189	218
YT-7747	74	YT-78191	109	YT-8026	429	YT-80529	426	YT-80791	427	YT-81594	152	YT-82280	398	YT-83190	218
YT-7750	75	YT-78192	109	YT-8027	429	YT-80552	426	YT-80794	427	YT-81595	152	YT-82288	400	YT-83200	218
YT-7751	75	YT-78193	109	YT-8028	429	YT-80553	426	YT-80795	427	YT-8165	152	YT-82291	400	YT-83201	218
YT-7752	75	YT-78194	109	YT-8029	429	YT-80554	426	YT-80796	427	YT-81651	152	YT-82292	400	YT-83202	218
YT-7753	75	YT-7826	110	YT-8030	429	YT-80555	426	YT-80797	427	YT-81652	152	YT-82293	400	YT-83203	218
YT-7800	110	YT-7829	110	YT-8031	429	YT-80556	426	YT-80798	427	YT-81654	152	YT-82401	150 247	YT-83204	218
YT-7801	110	YT-7834	110	YT-8032	429	YT-80557	426	YT-80799	427	YT-81655	152	YT-82421	150 247	YT-83205	218
YT-7802	110	YT-7846	110	YT-8033	429	YT-80558	426	YT-80800	427	YT-8166	152	YT-8245	151 246	YT-83206	218
YT-7803	110	YT-7847	110	YT-8034	429	YT-80559	426	YT-80801	427	YT-8173	152	YT-82455	150 246	YT-83207	218
YT-7804	110	YT-7848	110	YT-80355	428	YT-80560	426	YT-80802	427	YT-8174	152	YT-8271	151 246	YT-83208	218

YATO	page/strona	YATO	page/strona	YATO	page/strona	YATO	page/strona	YATO	page/strona	YATO	page/strona	YATO	page/strona
YT-83209	218	YT-83311	219	YT-83420	221	YT-8350	216	YT-8448	216	YT-8816	455	YT-8966	443
YT-83210	218	YT-83312	219	YT-83421	221	YT-8351	216	YT-8449	216	YT-8817	456	YT-8967	444
YT-83211	218	YT-83313	219	YT-83422	221	YT-8352	216	YT-8450	216	YT-8821	453	YT-8968	445
YT-83220	218	YT-83314	219	YT-83423	221	YT-8353	216	YT-8451	216	YT-8822	453	YT-8970	450
YT-83221	218	YT-83315	219	YT-83424	221	YT-8354	216	YT-8452	216	YT-8823	453	YT-8971	451
YT-83222	218	YT-83316	219	YT-83425	221	YT-8355	216	YT-8453	216	YT-8824	453	YT-8972	451
YT-83223	218	YT-83321	219	YT-83426	221	YT-8356	216	YT-8454	216	YT-8831	456	YT-8973	451
YT-83224	218	YT-83322	219	YT-83427	221	YT-8357	216	YT-8455	216	YT-8832	456	YT-8974	451
YT-83225	218	YT-83323	219	YT-83428	221	YT-8358	216	YT-8456	216	YT-8833	456	YT-8975	451
YT-83226	218	YT-83324	219	YT-83430	221	YT-8360	216	YT-8457	216	YT-8834	456	YT-8976	451
YT-83227	218	YT-83325	219	YT-83431	221	YT-8361	216	YT-8458	216	YT-8835	456	YT-8977	451
YT-83228	218	YT-83326	219	YT-83432	221	YT-8362	216	YT-8459	216	YT-8836	456	YT-8978	452
YT-83229	218	YT-83331	219	YT-83433	221	YT-8363	216	YT-8460	216	YT-8838	457	YT-8979	450
YT-83230	218	YT-83332	219	YT-83434	221	YT-8364	216	YT-8461	216	YT-8839	457	YT-8984	447
YT-83231	218	YT-83333	219	YT-83435	221	YT-8365	216	YT-8462	216	YT-8840	457	YT-8985	447
YT-83232	218	YT-83334	219	YT-83436	221	YT-8366	216	YT-8463	216	YT-8841	457	YT-8986	447
YT-83233	218	YT-83335	219	YT-83437	221	YT-8367	216	YT-8464	216	YT-8842	457	YT-8987	447
YT-83234	218	YT-83336	219	YT-83438	221	YT-8368	216	YT-8465	216	YT-8843	454	YT-8988	448
YT-83235	218	YT-83351	220	YT-83440	221	YT-8370	216	YT-8466	216	YT-8845	454	YT-8991	448
YT-83236	218	YT-83352	220	YT-83441	221	YT-8371	216	YT-8480	217	YT-8849	454	YT-8993	448
YT-83237	218	YT-83353	220	YT-83442	221	YT-8372	216	YT-8481	217	YT-8850	456	YT-9920	452
YT-83238	218	YT-83354	220	YT-83443	221	YT-8373	216	YT-8482	217	YT-8851	453	YT-9940	452
YT-83239	218	YT-83355	220	YT-83444	221	YT-8374	216	YT-8483	217	YT-8852	453	YT-9941	452
YT-83240	218	YT-83356	220	YT-83445	221	YT-8375	216	YT-8484	217	YT-8853	453	YT-9955	449
YT-83251	219	YT-83361	220	YT-83446	221	YT-8376	216	YT-8485	217	YT-8854	453	YT-99801	450
YT-83252	219	YT-83362	220	YT-83447	221	YT-8377	216	YT-8486	217	YT-8865	459	YT-99802	450
YT-83253	219	YT-83363	220	YT-83448	221	YT-8378	216	YT-85401	404	YT-8866	459	YT-99803	450
YT-83254	219	YT-83364	220	YT-83450	221	YT-8400	217	YT-85402	404	YT-8867	459	YT-99804	450
YT-83255	219	YT-83365	220	YT-83451	221	YT-8401	217	YT-85403	404	YT-8868	459	YT-99810	450
YT-83256	219	YT-83366	220	YT-83452	221	YT-8402	217	YT-85421	403	YT-8869	459	YT-99811	450
YT-83271	219	YT-83371	220	YT-83453	221	YT-8403	217	YT-85422	403	YT-8870	459	YT-99812	451
YT-83272	219	YT-83372	220	YT-83454	221	YT-8404	217	YT-85432	402	YT-8876	457	YT-99813	451
YT-83273	219	YT-83373	220	YT-83455	221	YT-8405	217	YT-85434	402	YT-8885	459	YT-99814	451
YT-83274	219	YT-83374	220	YT-83456	221	YT-8406	217	YT-85437	402	YT-8886	459	YT-99815	451
YT-83275	219	YT-83375	220	YT-83457	221	YT-8407	217	YT-85440	402	YT-8889	459	YT-99821	452
YT-83276	219	YT-83376	220	YT-83458	221	YT-8408	217	YT-8603	461	YT-8890	459	YT-99825	450
YT-83281	219	YT-83381	220	YT-83480	221	YT-8409	217	YT-86800	461	YT-8891	459	YT-99826	450
YT-83282	219	YT-83382	220	YT-83481	221	YT-8410	217	YT-86801	461	YT-8892	459	YT-99827	450
YT-83283	219	YT-83383	220	YT-83482	221	YT-8411	217	YT-86804	461	YT-8894	460	YT-99828	450
YT-83284	219	YT-83384	220	YT-83483	221	YT-8412	217	YT-86805	461	YT-8940	452	YT-99830	447
YT-83285	219	YT-83385	220	YT-83484	221	YT-8413	217	YT-86808	461	YT-8941	452	YT-99833	443
YT-83286	219	YT-83386	220	YT-83485	221	YT-8414	217	YT-86809	461	YT-8943	452	YT-99834	443
YT-83291	219	YT-83390	220	YT-83486	221	YT-8415	217	YT-8790	454	YT-8950	447	YT-99840	445
YT-83292	219	YT-83391	220	YT-83487	221	YT-8416	217	YT-8791	455	YT-8955	443	YT-99841	445
YT-83293	219	YT-83392	220	YT-83488	221	YT-8417	217	YT-8792	455	YT-8956	443	YT-99843	446 449
YT-83294	219	YT-83393	220	YT-83490	221	YT-8418	217	YT-8800	454	YT-8957	444	YT-99845	448
YT-83295	219	YT-83394	220	YT-83491	221	YT-8440	216	YT-8801	454	YT-8958	444	YT-99848	452
YT-83296	219	YT-83395	220	YT-83492	221	YT-8441	216	YT-8802	455	YT-8959	444	YT-99850	442
YT-83301	219	YT-83396	220	YT-83493	221	YT-8442	216	YT-8805	454	YT-8960	445	YT-99852	442
YT-83302	219	YT-83397	220	YT-83494	221	YT-8443	216	YT-8807	455	YT-8961	445 449	YT-99853	442
YT-83303	219	YT-83398	220	YT-83495	221	YT-8444	216	YT-8808	455	YT-8962	446 449		
YT-83304	219	YT-83399	220	YT-83496	221	YT-8445	216	YT-8809	455	YT-8963	444		
YT-83305	219	YT-83400	220	YT-83497	221	YT-8446	216	YT-8811	454	YT-8964	444		
YT-83306	219	YT-83401	220	YT-83498	221	YT-8447	216	YT-8815	455	YT-8965	443		

## L

I. TOYA S.A. informuje, iż: 1) niniejszy katalog nie stanowi oferty w rozumieniu prawa cywilnego; 2) prezentowane w niniejszym katalogu artykuły mogą w rzeczywistości odbiegać od wskazanego na zdjęciach wzoru, w szczególności jeżeli chodzi o cechy zewnętrzne, tj. wielkość, kolor, sposób opakowania, ilość przedmiotów w opakowaniu; 3) nie ponosi odpowiedzialności za drobne różnice w sposobie pakowania czy właściwościach artykułów pozostających bez wpływu na jego przeznaczony cel lub sposób użytkowania; 4) nie ponosi odpowiedzialności wynikającej z jakichkolwiek niedokładności lub nieścisłości, co do informacji zawartych w przedmiotowym katalogu; 5) nie ponosi odpowiedzialności za ewentualną szkodę powstałą w wyniku otrzymania towaru o innych właściwościach niż prezentowany na zdjęciach.

II. Pomimo najlepszych starań poczynionych przez TOYA S.A. nie może ona zagwarantować, iż informacje zawarte w niniejszym katalogu w pełni odpowiadają rzeczywistości.

III. Wszelkie decyzje podjęte na podstawie informacji zawartych w przedmiotowym katalogu podejmowane są na własne ryzyko osoby, która korzysta z tych informacji.

## GB

I. TOYA S.A. informs that: 1) the present catalogue does not constitute an offer as construed in the civil law; 2) the goods presented in the present catalogue may in fact differ from the models shown in the pictures, particularly as far as external properties are concerned, namely size, colour, packaging, number of items in the package; 3) the company will not be held responsible for small differences in packaging or properties of the goods, which do not affect the purpose or the exploitation of the tools; 4) the company will not be held responsible for any inaccuracies or imprecision regarding the information presented in the catalogue; 5) the company will not be held responsible for any damage caused by goods whose properties differ from those of the tools presented in the photographs.

II. In spite of all the efforts made by TOYA S.A., the company cannot guarantee the information contained in the present catalogue fully correspond to the reality.

III. Any decisions made on the basis of the information contained in the present catalogue will be made at the risk of the person who makes them using the aforementioned information.

## D

I. TOYA S.A. informiert, dass: 1) der vorliegende Katalog kein Angebot im zivilrechtlichen Sinne darstellt; 2) die im vorliegenden Katalog präsentierten Artikel in der Realität von den auf den Musterfotos gezeigten abweichen können, und zwar besonders dann, wenn es um äußere Eigenschaften geht, wie z.B. Größe, Farbe, Art der Verpackung, Anzahl der Gegenstände in der Verpackung; 3) sie keine Verantwortung für geringfügige Unterschiede bei der Verpackungsart oder den Eigenschaften der Artikel übernimmt, die ohne Auswirkungen auf seinen Bestimmungszweck oder die Art der Nutzung bleiben; 4) sie keine Verantwortung für irgendwelche Oberflächlichkeiten und Ungenauigkeiten bzgl. der im Sachkatalogkatalog enthaltenen Informationen übernimmt; 5) sie keine Verantwortung für eventuelle Schäden, die im Ergebnis des Erhalts der Ware mit anderen als auf den Fotos dargestellten Eigenschaften entstanden sind, übernimmt.

II. Trotz großer Bemühungen seitens TOYA S.A. kann die Firma nicht garantieren, dass die im vorliegenden Katalog enthaltenen Informationen voll der Realität entsprechen.

III. Sämtliche Entscheidungen, die auf der Grundlage der im Sachkatalog enthaltenen Informationen getroffen wurden, gehen auf das Risiko der Person, die diese Informationen benutzt.

## S

I. TOYA S.A. заявляет: 1) настоящий каталог не является торговым предложением с точки зрения гражданского законодательства; 2) изделия, представленные в настоящем каталоге, могут отличаться от образцов на снимках, особенно внешним видом, то есть размером, цветом, способом упаковки, количеством предметов в упаковке; 3) производитель не отвечает за мелкие отличия в способе упаковки или свойствах изделий, которые не влияют на предназначение или способ пользования изделиями; 4) производитель не отвечает за мелкие неточности в сведениях из предметного каталога; 5) производитель не отвечает за ущерб, нанесенный вследствие поставки товара, отличающегося параметрами от указанного на снимках.

II. Несмотря на все усилия в данном направлении, компания TOYA S.A. не гарантирует, что информация, метящаяся в настоящем каталоге, полностью отвечает действительности.

III. Риск, связанный с любыми решениями, принятыми на основании информации из предметного каталога, берут на себя лица, пользующиеся указанной информацией.

I. TOYA S.A. informuje že: 1) tento katalog nepředstavuje nabídku ve smyslu občanského práva; 2) výrobky prezentované v tomto katalogu se mohou ve skutečnosti lišit od modelů uvedených na obrázcích, zejména co se týká vnějších znaků, tj. velikosti, barvy, způsobu balení, počtu předmětů v balení; 3) nenese odpovědnost za drobné rozdíly ve způsobu balení nebo ve vlastnostech výrobků, které nemají zásadní vliv na jejich určený účel nebo způsob používání; 4) nenese odpovědnost vyplývající z jakýchkoli nepřesností co do informací uvedených v předmětném katalogu; 5) nenese odpovědnost za případné škody vzniklé v důsledku obdržení zboží s jinými vlastnostmi, než je uvedeno na obrázcích.

II. Navzdory mimořádnému úsilí vynaloženému firmou TOYA S.A. tato nemůže garantovat, zda informace uvedené v tomto katalogu zcela odpovídají skutečnosti.

III. Veškerá rozhodnutí přijatá na základě informací uvedených v předmětném katalogu jsou přijímána na vlastní riziko osoby, která tyto informace využívá.

## H

I. A TOYA S.A. tájékoztatja, hogy: 1) a jelen katalógus a polgári jog szerint nem kereskedelmi ajánlat; 2) a jelen katalógusban bemutatott árucikkek a valóságban eltérhetnek a képeken látható mintáktól, különösen a külső tulajdonságok, mint a méret, szín, csomagolási mód, a csomagban lévő tárgyak száma tekintetében; 3) nem vállal felelősséget a csomagolás módjában vagy az árucikkek olyan tulajdonságaiban történt változtatásokért, amelyek nem befolyásolják lényeges módon annak rendelkezését vagy a felhasználás módját; 4) nem vállal felelősséget a jelen katalógusban lévő információk pontatlanságáért; 5) nem vállal felelősséget azokért az esetleges károkért, amik az árucikkek a fényképeken látható tulajdonságoktól eltérő tulajdonságokkal történő leszállításából erednek.

II. A TOYA S.A. minden igyekezete ellenére nem tudja garantálni, hogy a jelen katalógusban található információk teljes egészében megfelelnek a valóságnak.

III. A tárgyi katalógusban található információk alapján meghozott bármilyen döntés annak a személynek a rizikója, aki ezeket az információkat felhasználja.

I. TOYA S.A. informează că: 1) prezentul catalog nu constituie ofertă în înțelesul dreptului civil; 2) articolele prezentate în prezentul catalog se pot diferi față de mostrele din fotografiile, în special aspectul exterior, adică mărimea, culoarea, modul de ambalare, cantitatea obiectelor în ambalaj; 3) nu-și asumă răspunderea referitor la mici diferențe la modul de ambalare sau la articolele al căror proprietăți nu au influență referitor la destinația sau modul lor de utilizare; 4) nu-și asumă răspunderea referitor la orice inexactitate sau imprecizie, datorită informațiilor cuprinse în catalogul respectiv; 5) nu-și asumă răspunderea referitor la o eventuală pagubă ca urmarea primirii marfei cu alte proprietăți decât cele prezentate pe fotografiile; 6) Cu toate strădaniile TOYA S.A., firma nu poate garanta că, informațiile din prezentul catalog corespund realității;

III. Orice decizie preluată în baza informațiilor cuprinse în catalogul respectiv, sunt preluate pe riscul și răspunderea persoanei care a făcut folos de aceste informații.

I. TOYA S.A. comunica lo siguiente: 1) el presente catálogo no constituye una oferta, en el sentido que la noción adquiere en la ley civil; 2) los artículos presentados en el presente catálogo pueden en realidad diferir de los modelos indicados en las fotografías, especialmente en cuanto a sus propiedades externas, es decir el tamaño, el color, el empaque o la cantidad de los objetos en el empaque; 3) la empresa no se hace responsable por pequeñas diferencias en cuanto al empaque o las propiedades de los artículos, siempre y cuando estas diferencias no afectan el propósito o el modo de operación de las herramientas; 4) la empresa no se hace responsable por ninguna imprecisión en cuanto a la información presentada en el presente catálogo; 5) la empresa no se hace responsable por ningún daño que surja del hecho de que los artículos recibidos difieran de los artículos presentados en las fotografías en cuanto a sus propiedades.

II. A pesar de los mejores intentos de parte TOYA S.A. la empresa no puede garantizar que la información presentada en el presente catálogo corresponda completamente a la realidad.

III. Todas las decisiones tomadas en base a la información presentada en el presente son responsabilidad de la persona que recurra a la dicha información.





**MANUFACTURER / PRODUCENT**

TOYA S.A.  
ul. Sołtysowicka 13-15  
51-168 Wrocław  
☎ (+48 71) 32 46 200  
fax: (+48 71) 32 46 370  
sales@yato.pl (sale)  
export@yato.pl (export)  
import@yato.pl (import)

ODDZIAŁ WARSZAWSKI  
Teren ProLogis Park Nadarzyn  
al. Kasztanowa 160  
05-831 Młochów k. Warszawy  
☎ (+48 22) 73 82 800  
☎ (+48 22) 73 82 828  
sales@yato.pl (sale)  
export@yato.pl (export)

TOYA ROMANIA S.A.  
Sos. Odăi Nr. 109-12  
Sector 1, București  
☎ 0040 031 710 8692  
office@yato.ro

YATO TOOLS (SHANGHAI) Co., Ltd  
Building #28, No. 1365 lane  
East KangQiao Road  
201315 Shanghai  
☎ (+86 21) 209 811 07  
fax: (+86 21) 209 811 08  
yato@yato-sh.com

**YOUR TRUSTED SUPPLIER: / TWÓJ ZAUFANY DOSTAWCA:**



**www.yato.com**

COPYRIGHT © TOYA S.A. 2015

**GET ACQUAINTED WITH OUR WIDE OFFER:  
ZOBACZ NASZĄ BOGATĄ OFERTĘ:**

